

# MATERIAL HANDLING & STORAGE



Hand Trucks.....	4-11
Platform Trucks.....	12-17
Panel Trucks.....	18-19
Carts.....	20-27
Wire Mesh Trucks .....	28-29
Hoppers .....	30
Tilt Trucks .....	31
Box Trucks .....	32-33
Wire Reel Caddies .....	34
Machine & Equipment Movers .....	35
Dollies .....	36-37
Pallet Trucks .....	38-42
Fork Lift Accessories & Attachments .....	43
Lift Tables .....	44-50
Pallet Lifters.....	51-53
Lifting Equipment .....	54-68
Dock Equipment .....	69-78
Casters .....	79-86
Drums .....	87-90
Drum Equipment .....	91-103
Pumps .....	104-110
Ladders & Scaffolding.....	111-124
Workbenches .....	125-141
Storage Cabinets .....	142-149
Lockers.....	150-153
Pallets.....	154-156
Racking & Shelving.....	157-169
Wire Shelving.....	170-177
Pipe Fittings .....	178-180
Enclosures & Guards.....	181-188
Small Parts Storage.....	189-190
Bulk Containers.....	190-191
Small Parts Storage.....	192-201
Racking & Shelving.....	202-203
Bins .....	204-217
Containers .....	218-225



# HAND TRUCKS

## RUBBER WHEEL HAND TRUCKS

- Constructed of 1", 16-gauge steel tubing
- Nose plate 7-gauge steel
- Overall width: 19-1/2"
- Wheel dimensions: 8" x 2"
- Powder-coated



KLETON

Model No.	Description	Overall Height"	Nose Plate Dim. W" x D"	Capacity lbs.	Wt. lbs.	Price /Each
MK728	Continuous Handle	46	14 x 8 1/2	600	23	115.00
MK729	Dual Handle	48	14 x 8 1/2	600	24	115.00
MN103	P-Handle	51	14 x 9	600	24	115.00
ML812	Replacement Wheels	-	-	-	-	18.95



## PNEUMATIC WHEEL HAND TRUCKS

- Constructed of 1", 16-gauge steel tubing
- Nose plate 8-gauge steel
- Overall width: 21-1/2"
- Wheel dimensions: 10" x 3"
- Powder-coated



KLETON

Model No.	Description	Overall Height"	Nose Plate Dim. W" x D"	Capacity lbs.	Wt. lbs.	Price /Each
MH300	Dual Handle	46	14 x 9	600	20	119.00
MH301	Continuous Handle	48	14 x 9	600	22	119.00
MH302	P-Handle	51	14 x 9	600	22	119.00
ML810	Replacement Wheels	-	-	-	-	21.20



## FLAT FREE WHEEL HAND TRUCKS

- Constructed of 1", 16-gauge steel tubing
- Nose plate 8-gauge steel
- Overall width: 22"
- Wheel dimensions: 10" x 3 1/2"
- Powder-coated



KLETON

Model No.	Description	Overall Height"	Nose Plate Dim. W" x D"	Capacity lbs.	Wt. lbs.	Price /Each
MN389	Dual Handle	46	14 x 9	600	20	179.00
MN390	Continuous Handle	48	14 x 9	600	22	179.00
MN391	P-Handle	51	14 x 9	600	22	179.00
MN378	Replacement Wheels	-	-	-	-	35.30



## HEAVY-DUTY HAND TRUCKS

- All welded construction
- Constructed of 1-1/4", 14 gauge steel tube
- Nose plate 6-gauge steel
- Overall Width: 20"
- Powder-coated paint
- Durable Kleton blue enamel finish



KLETON

Model No.	Description	Overall Height"	Nose Plate Dim. W" x D"	Capacity lbs.	Wt. lbs.	Price /Each
<b>10" X 3" PNEUMATIC WHEELS</b>						
MK731	Dual Handle	46	14 x 8	800	36	175.00
MO120	Continuous Handle	50	14 x 8-3/4	800	28	175.00
MO122	P-Handle	50-3/4	14 x 8-3/4	800	29	175.00
ML811	Replacement Wheels	-	-	-	-	24.45
<b>8" X 2" MOLD-ON RUBBER WHEELS</b>						
MK730	Dual Handle	46	14 x 8	1000	36	169.00
MO119	Continuous Handle	50	14 x 8-3/4	1000	28	169.00
MO121	P-Handle	50-3/4	14 x 8-3/4	1000	29	169.00
ML813	Replacement Wheels	-	-	-	-	22.50



## HAND TRUCK ATTACHMENTS

- Constructed of 1", 14-gauge steel tubing
- Allows extra versatility to adapt to changing material handling requirements without the extra cost
- Easy to install
- Designed to fit most hand trucks with a 14" frame width
- Durable Kleton blue enamel finish



**KLETON**

Model No.	Description	Wt. lbs.	Price /Each
MA378	Chair Mover Attachment	7.25	265.00
MA385	Table Mover Attachment	12	319.00



MA378



MA385

## CONVERTIBLE DELUXE STEEL HAND TRUCKS

- Quickly converts from a 2-wheel hand truck to a 4-wheel platform truck
- Constructed of 1" round 14-gauge steel tubing
- 8" x 14" nose plate
- Comes with 2 welded-on stair glides
- Two 10" full pneumatic wheels and two 3" bolted-on casters
- Hand truck capacity: 600 lbs.; platform truck capacity: 800 lbs.
- Durable Kleton blue enamel finish



Model No.	Overall Dimensions W" x D" x H"	Wt. lbs.	Price /Each
ML320	14 x 43 x 45	58	525.00

## DELUXE 12" NOSE PLATE HAND TRUCKS

- Constructed of 1" round 14-gauge steel tubing
- Transport short to tall loads easily
- P handle ideal for one hand control
- Strong 12" x 14" x 3/16" thick nose plate
- Double welded 3/16" x 1 1/2" cross bars
- Add a folding nose extension to be able to transport larger loads
- Two 10" full pneumatic wheels
- Capacity: 700 lbs.
- Durable Kleton blue enamel finish

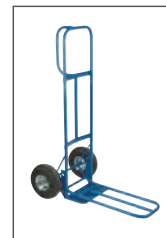

ML323  
Nose Extension



ML321

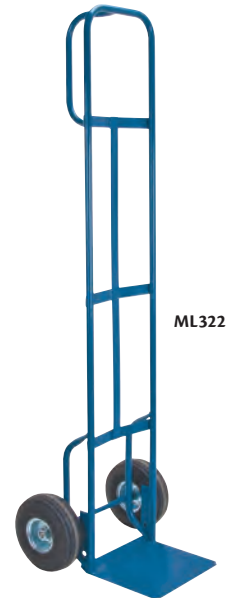

ML322



Model No.	Description	Overall Dimensions W" x H"	Wt. lbs.	Price /Each
ML321	Lo-Boy	23 x 50	40	299.00
ML322	Hi-Boy	23 x 72	42	345.00
ML323	Nose extension	12 x 22" Nose Length	7.75	133.00

## HEAVY-DUTY SPADE TRUCKS

- Constructed of double-welded 1 1/4" round 14-gauge steel tubing
- Oversized nose plate and easy grip frame helps with the balancing of larger items
- Tapered 22" x 1/4" x 13" deep thick nose plate
- Two 10" mould-on rubber wheels
- Durable Kleton blue enamel finish



Model No.	Dimensions W" x H"	Cap lbs.	Wt. lbs.	Price /Each
ML324	22" x 53"	1200	68	395.00

## HEAVY-DUTY DUAL HANDLE HAND TRUCKS

- Constructed of 1 1/4", 14-gauge steel tubing
- Nose plate 6-gauge steel
- Overall height: 46"
- Overall width: 20"
- 8" x 12" nose plate
- Powder-coated



Model No.	Wheel Size"	Capacity lbs.	Wt. lbs.	Price /Each
MA376	10 x 2	1000	40	425.00



## LOAD RETENTION HAND TRUCKS

- Constructed of 1" round 14-gauge steel tubing
- 18 1/2" x 53" load retention grill to safely handle wide and awkward loads
- 7-gauge steel nose plate
- 18 1/2" W x 9 3/4" D nose plate
- Two 10" full pneumatic wheels
- Capacity: 600 lbs.
- Durable Kleton blue enamel finish

Model No. MN412  
Price/Each \$395.00



### REPLACEMENT PARTS

Model No.	Description	Price /Each
ML030	Hand Grip	5.10



# HAND TRUCKS

## FLAT-FREE WHEEL ALUMINUM HAND TRUCKS

- Strong lightweight hand truck provides exceptional durability and versatility
- Weld-free construction for easy maintenance
- Wheel Size: 10" H x 3" W
- Capacity: 500 lbs.
- Shipped knocked down



Model No.	Handle Type	Overall Dimensions W" x H"	Nose Plate Dimensions W" x D"	Price /Each
MO078	Continuous	14 x 48	14 x 7-1/2	270.00
MO896	Continuous	18 x 48	18 x 7-1/2	280.00
MO077	Continuous	18 x 48	18 x 10	310.00
MO075	Continuous	14 x 52	14 x 7-1/2	280.00

Model No.	Handle Type	Overall Dimensions W" x H"	Nose Plate Dimensions W" x D"	Price /Each
MO072	Dual Handle	18 x 52	18 x 7-1/2	295.00
MN032	Dual Handle	18 x 52	18 x 10	343.00
MO898	P-Handle	16 x 52	14 x 7-1/2	318.00
MO080	P-Handle	18 x 52	18 x 7-1/2	310.00
MN029	P-Handle	18 x 52	18 x 7-1/2	321.00

## PNEUMATIC WHEEL ALUMINUM HAND TRUCKS

- Strong lightweight hand truck provides exceptional durability and versatility
- Weld-free construction for easy maintenance
- Wheel Size: 10" H x 3" W
- Capacity: 500 lbs.
- Shipped knocked down



Model No.	Handle Type	Overall Dimensions W" x H"	Nose Plate Dimensions W" x D"	Price /Each
MO074	P-Handle	14 x 52	14 x 7-1/2	270.00
MO079	P-Handle	18 x 52	18 x 7-1/2	284.00
MN028	P-Handle	18 x 52	18 x 7-1/2	285.00
MO894	P-Handle	18 x 52	18 x 7-1/2	273.00
MO893	Continuous	16 x 48	14 x 7-1/2	264.00
MO895	Continuous	16 x 48	14 x 7-1/2	254.00

Model No.	Handle Type	Overall Dimensions W" x H"	Nose Plate Dimensions W" x D"	Price /Each
MN026	Continuous	16 x 52	14 x 7-1/2	307.00
MO076	Continuous	18 x 48	18 x 10	285.00
MN030	Dual Handle	16 x 52	18 x 7-1/2	289.00
MO071	Dual Handle	18 x 52	18 x 7-1/2	280.00
MN031	Dual Handle	18 x 52	18 x 10	308.00
MN033	Dual Handle	21 x 52	18 x 7-1/2	284.00



## RUBBER WHEEL ALUMINUM HAND TRUCKS

- Strong lightweight hand truck provides exceptional durability and versatility
- Weld-free construction for easy maintenance
- Wheel Size: 8" H x 2" W
- Capacity: 500 lbs.
- Shipped knocked down



Model No.	Wheel Material	Overall Dimensions			Nose Plate Dimensions			Price /Each
		W"	x	H"	W"	x	D"	
<b>DUAL HANDLE</b>								
<b>MO891</b>	Mold-On Rubber	20	x	52	18	x	7-1/2	<b>280.00</b>
<b>P-HANDLE</b>								
<b>MO073</b>	Rubber	14	x	52	14	x	7-1/2	<b>280.00</b>
<b>MN027</b>	Mold-On Rubber	21	x	48	18	x	7-1/2	<b>290.00</b>
<b>CONTINUOUS HANDLE</b>								
<b>MN024</b>	Mold-On Rubber	16	x	48	14	x	7-1/2	<b>260.00</b>
<b>MN025</b>	Mold-On Rubber	20	x	48	18	x	7-1/2	<b>285.00</b>
<b>MO892</b>	Mold-On Rubber	20	x	48	18	x	7-1/2	<b>270.00</b>

## STAIR CLIMBING HAND TRUCK

- Triple-wheel assembly that works great when going up and down stairs
- Wheels smoothly rotate as you go up or down each step
- 6-1/4" solid rubber wheels (3 per side)
- Handle Type: Continuous
- Frame Material: Steel
- Wheel Material: Rubber
- Capacity: 300 lbs.
- Overall Height: 45-5/8"
- Overall Width: 23-3/4"

Model No. **MP721**  
Price/Each **\$275.00**

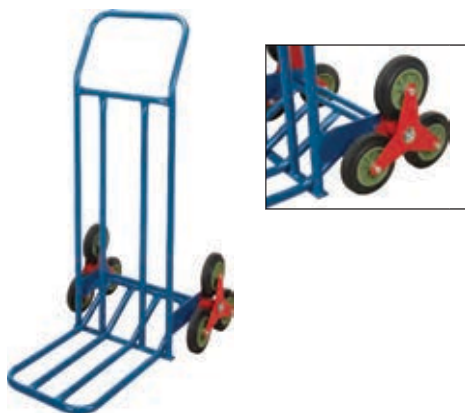

## HAND TRUCK ACCESSORIES



### STAIR CLIMBERS

Model No. **MN015**  
Price/Each **\$51.55**



**MN015**

### NOSE EXTENSIONS

- Size: 20"
  - Only compatible with cast nose plates
- Model No. **MN019**  
Price/Each **\$41.00**



**MN019**

### REPLACEMENT WHEELS

- 10" Pneumatic
- Model No. **MN012**  
Price/Each **\$29.45**
  - 8" Mold-on rubber

Model No. **MN013**  
Price/Each **\$39.95**
  - 10" Flat-free

Model No. **MN014**  
Price/Each **\$48.75**



**MN012**



**MN013**



**MN014**

## FOLDING HAND TRUCK

- Lightweight and durable aluminum construction
- Convenient folding construction permits storage in small spaces
- Comfortable ergonomic handle
- Elastic straps help to secure load
- 5" x 1 1/4" non-marking and shock-absorbing rubber wheels
- 15 1/4" W x 11" D nose plate
- Capacity: 175 lbs.
- Overall Dimensions: 15-1/2" W x 39-5/8" H
- Weight: 9 lbs.

Model No. **ML447**  
Price/Each **\$115.00**



# HAND TRUCKS

## ALUMINUM HAND TRUCKS

- Strength, durability and versatility in a lightweight truck
- Totally modular trucks have no welds to break
- 500-lb. capacity on all models
- Shipped knocked down.



**MAGLINER®**



Model No.	Nose Plate W" x D"	Overall Height"	Wheels	Wt. lbs.	Price /Each
A. MA250	14 x 7 1/2	48	8" Mold-On	18	449.00
B. MA269	18 x 7 1/2	48	8" Mold-On	19	499.00
C. MA275*	14 x 7 1/2	48	10" Pneumatic	21	555.00
D. MA258	14 x 7 1/2	52	8" Mold-On	19	509.00
D. MA255	14 x 7 1/2	52	10" Pneumatic	21	545.00
E. MA263**	14 x 7 1/2	48	8" Mold-On	21	555.00
E. MA261**	14 x 7 1/2	48	10" Pneumatic	24	585.00

\*\* Includes stair climbers

Model No.	Nose Plate W" x D"	Overall Height"	Wheels	Wt. lbs.	Price /Each
F. MA271	18 x 9	48	8" Mold-On	19	539.00
F. MA270	18 x 9	48	10" Pneumatic	22	565.00
G. MA266	18 x 7 1/2	52	8" Mold-On	19	489.00
G. MA265	18 x 7 1/2	52	10" Pneumatic	22	519.00
H. MA268	18 x 7 1/2	52	8" Mold-On	19	535.00
H. MA267	18 x 7 1/2	55	10" Pneumatic	22	559.00

\* Frame has a curved back for cylindrical or flat loads

## ACCESSORIES

### FRAME EXTENSIONS

- 16" High  
U-frame extension  
Model No. MD439  
Price/Each \$31.50
- 23" High  
U-frame extension  
Model No. MD438  
Price/Each \$38.90
- 32" High  
U-frame extension  
Model No. MD437  
Price/Each \$54.50



### STAIR CLIMBERS

- Aluminum with replaceable low-friction polymer skid bars

Model No. MA315  
Price/Each \$82.90



### FOLDING EXTENSIONS

- 20" extruded channel nose extension  
Model No. XZ273  
Price/Each \$115.00
- 30" extruded channel nose extension  
Model No. MA317  
Price/Each \$135.00
- 24" formed plate extension, low plate profile for sliding under loads  
Model No. XZ272  
Price/Each \$219.00



## SELF-STABILIZING ALUMINUM HAND TRUCK CONVERSION KIT

- Kit includes wheel brackets, axle, all hardware, support arms, lift bar, kickstand, double or triple row multi-directional wheels, and assembly instructions

**MAGLINER®**



Model No.	Caster Type	For Wheel Size"	Stair Climbers	Price /Each
<b>FOR INDOOR CONTROLLED ENVIRONMENTS</b>				
M0529	Double Row	8	Not Included	629.00
M0531	Double Row	10	Not Included	629.00
M0533	Double Row	10	Included	759.00
<b>FOR OUTDOOR RUGGED ENVIRONMENTS</b>				
M0530	Triple Row	8	Not Included	725.00
M0532	Triple Row	10	Not Included	719.00
M0534	Triple Row	10	Included	875.00

## CONVERTIBLE HAND TRUCKS

- Converts easily from a 2-wheel hand truck to a 4-wheel platform truck
- Lightweight aluminum construction
- 5" polyurethane casters and 10" pneumatic wheels
- Shipped assembled



**KLETON**

Model No.	Nose Plate W" x D"	Hand Truck Cap. lbs.	Platform Truck Cap. lbs.	L" x W"	Price /Each
MP503	18 x 10	600	1250	43 x 12	445.00

## CONVERTIBLE HAND TRUCKS

- Converts easily from a 2-wheel hand truck to a 4-wheel platform truck
- 5" polyurethane casters and 10" flat-free wheels
- Frame Material: Aluminum
- Wheel Material: Pneumatic
- Wheel Size: 10" H x 2" W
- Weight: 42 lbs.
- Shipped assembled



**KLETON**

Model No.	Nose Plate W" x D"	Hand Truck Cap. lbs.	H"	Platform Truck Cap. lbs.	L" x W"	Price /Each
MP504	18 x 7-1/2	550	62	800	56 x 20	365.00

## SELF-STABILIZING ALUMINUM HAND TRUCK

- Strength, durability and versatility in a lightweight truck
- Totally modular trucks have no welds to break
- Keeps the same stability with heavy loads
- Can be used in very confined areas
- No need to support load when stationary
- Frame Material: Aluminum
- Nose Plate Dimensions: 18" W x 7-1/2" D
- Wheel Material: Micro-Foam
- Wheel Size: 10" H x 3.5" W
- Capacity: 500 lbs
- Overall Width: 21"
- Shipped knocked down



**MAGLINER®**

Model No.	Handle Type	Caster Type	Frame Type	Price /Each
MO524	Continuous	Double Row	Straight	1209.00
MO525	Dual Handle	Triple Row	Straight	1375.00
MO526	P-handle	Double Row	Curved	1255.00
MO527	P-handle	Double Row	Straight	1249.00
MO528	Dual Handle	Double Row	Curved	1199.00

## GEMINI® CONVERTIBLE ALUMINUM TRUCKS

**MAGLINER®**



- Converts in seconds from a 2-wheel hand truck to a 4-wheel platform truck
- Lightweight, high strength aluminum construction
- Balanced to assure easier wheeling and positive load control
- 18" wide x 7 1/2" deep rugged cast aluminum nose plate
- 5" swivel casters
- 10" x 3 1/2" full pneumatic wheels
- 16 5/8" frame width, 20 1/2" O.A. width
- Shipped knocked down



Gemini Jr.

Gemini Sr.

Model No.	Hand Truck Cap.	Hand Truck Ht."	Platform Truck Cap. lbs.	Platform Truck Ht."	Length"	Wt. lbs.	Price /Each
MA319	500 lbs.	51	1000	40	38	44	905.00
MA320	500 lbs.	61	1000	45 1/8	51	45	949.00
OPTIONAL SNAP-ON DECK					Wt. lbs.	Price/Each	
MB198	43 1/4" For Gemini Jr.				5		219.00
MB197	56" For Gemini Sr.				6		239.00

## THREE-POSITION SPARTAN III™ CONVERTIBLE HAND TRUCKS

- Can be used to transport all your needs, from general use items to bulky equipment
- 3 Positions: Vertical - 2 wheel, 45 Degree - 4 wheel, Platform - 4 wheel
- 7.5" W x 27" L recessed folding nose extension
- Handle type: Continuous handle
- Handle height: 48"
- 5" x 1.25 swivel casters
- 10" pneumatic wheels
- Capacity vertical 2 wheel: 500 lbs.
- Capacity 45 degree 4 wheel: 500 lbs.
- Capacity 4 wheel Platform: 750 lbs.
- Frame bed: 12" W x 51" L
- Shipped knocked down, boxed



**WESCO®**

Model No.	Frame Material	Nose Plate Dimensions W" x D"	Overall Dimensions W" x H"	Colour	Wt. lbs.	Price /Each
MN680	Aluminum	18 x 7.5	21.5 x 52	Aluminum	42	778.00

## SPARTAN ALUMINUM ECONOMY CONVERTIBLE TRUCKS

- Converts easily from 2-wheel to 4-wheel
- 10" pneumatic wheels & 5" casters
- Frame Material: Aluminum
- Nose Plate Dimensions: 18" W x 7-1/2" D
- Hand Truck Capacity: 500 lbs.
- Platform Truck Capacity: 1000 lbs.
- Shipped knocked down



MH257



**WESCO®**

Model No.	Description	Size"	Price /Each
MH257	Jr.	52	737.00
MH258	Sr.	61-1/2	768.00



# HAND TRUCKS

## FOLDING HAND TRUCKS

- Heavy-duty construction
- Easy to use latch system may be engaged with one hand
- 8" mold-on rubber wheels
- Comfort grip handle
- 14" x 7" locking folding nose plate
- Overall height: 48"
- Capacity: 500 lbs.
- Weight: 22 lbs.

Model No. MN117  
Price/Each \$729.00



**MAGLINER®**

## Y-CABLE BRAKE HAND TRUCKS

- Provides safer load control and reduces operator's accumulated muscle strain
- Easy ergonomic self-equalizing brake actuators
- 18" x 9" nose plate
- 10" pneumatic wheels
- Stair climber included
- Overall height: 60"
- Capacity: 500 lbs.
- Weight: 38 lbs.

Model No. MN119  
Price/Each \$1029.00



**MAGLINER®**

## PORTABLE POLY HAND TRUCK CURB RAMP

- Lightweight HDPE construction
- Two handles for easy carrying and handling
- Ergonomic method to move heavy loads over curbs or up steps
- Raised surface for excellent traction in all weather conditions
- Colour: Yellow
- For Use With: Hand trucks & wheeled carts
- Usable Width: 23-1/2"



**KLETON**

Model No.	Height"		Overall Dimensions W" x L"	Capacity lbs.	Price /Each
	Min	Max			
MP740	4-13/16	8	27 x 27	1000	115.00

## HAND TRUCKS WITH SWIVEL CASTERS

- 4" rear poly casters allow small diameter turns in tight areas
- Combination two handle and utility bar design reduces strain of lifting, lowering and transporting
- 8" deep nose plate
- 10" x 2 3/4" semi-pneumatic front wheels
- Overall dimensions: 20 1/2" W x 47 1/2" H
- Capacity: 800 lbs.
- Weight: 53 lbs.

Model No. MD758  
Price/Each \$909.00

**WESCO®**



## PORTABLE POLY HAND TRUCK DOCK PLATES

- Lightweight, ergonomic design is easy to use
- Beveled entry and exit edges
- For use with two and four-wheeled dollies, hand trucks and carts
- Raised surface for excellent traction in all weather conditions
- Aluminum legs for durability and strength
- Constructed of yellow HDPE



MO110

**EAGLE**  
Justice Safety Group

Model No.	Width Inside Curbs"	Overall Dimensions			Capacity lbs.	Price /Each
		W" x L" x H"	x	x		
M0110	35	35 x 36 x 5	x	5	750	649.00
M0111	48	45 x 36 x 5	x	5	750	895.00

## SHIPPING CONTAINER RAMPS

- For use with hand trucks and dollies for loading and unloading
- Features a hook rail that attaches to the doorkeepers for secure, three-point contact and support



**EAGLE**  
Justice Safety Group

Model No.	Height"		Overall Dimensions W" x L"	Capacity lbs.	Price /Each
	Min	Max			
M0113	6-21/23	10	35 x 36	750	599.00

**AURORA**  
TOOLS

Celebrating  
**15**  
YEARS

**EXCEEDING EXPECTATIONS**

## APPLIANCE TRUCK

- Move large appliances easily
- Vinyl bumpers on face of truck to prevent damage to appliances
- Heavy-duty continuous stair climbers for easy climbing/descending
- 8" solid rubber wheels
- Ratchet mechanism for easy fastening of loads
- Overall dimensions: 14 1/2" L x 24" W x 59" H
- Step climber weight capacity of 250 lbs.
- Capacity: 550 lbs.
- Weight: 46 lbs.
- All-welded construction

**Model No. ML616**  
**Price/Each \$545.00**

**KLETON**



## VENDING MACHINE APPLIANCE TRUCK

- Move large appliances easily
- Vinyl bumpers on face of truck to prevent damage to appliances
- Heavy-duty continuous stair climbers for easy climbing/descending
- Fold out rear legs with two 4" swivel casters
- 8" solid rubber front wheels
- Ratchet mechanism for easy fastening of loads
- Overall dimensions: 14 1/2" L x 24" W x 66" H
- Step climber weight capacity of 250 lbs.
- Capacity: 850 lbs.
- Weight: 65 lbs.
- All-welded industrial construction

**Model No. ML617**  
**Price/Each \$625.00**

**KLETON**



## INDUSTRIAL APPLIANCE TRUCK

- Vinyl frontal protection prevents damage to appliances
- Easily move large appliances
- Continuous stair climbers for easy ascending/descending
- 8" diameter solid rubber wheels
- All-welded industrial construction
- Frame Material: Steel
- Nose Plate Dimensions: 24" W x 5" D
- Capacity: 550 lbs.
- Handle Type: Continuous Handle
- Wheel Material: Solid Rubber
- Wheel Size: 8"H x 2" W
- Colour: Red / Black
- Steel Nose Plate ga.: 10
- Steel Tubing ga.: 14

**KLETON**

Model No	Overall Dimensions W" x D" x H"	Wt. lbs.	Price /Each
MP505	24 x 13.5 x 59	44	335.00



## HEAVY-DUTY APPLIANCE HAND TRUCK

- 1" heavy-duty pipe frame
- Wheel guards standard
- Dual handle design
- Kick out four wheel model
- Frame Material: Steel
- Includes 3.5" mold-on rubber swivel casters



**WESCO**

Model No.	Overall Dimensions W" x H"	Nose Plate Dimensions W" x D"	Capacity lbs.	Price /Each
M0147	20-1/2 x 50-1/4	16-1/2 x 10	1000	1449.00

## LIFTKAR® ALUMINUM STAIR CLIMBING HAND TRUCKS

- Battery-powered stair climbing hand trucks help reduce worker fatigue and the risk of injury, as well as reduce the number of employees needed to deliver cargo
- Pivoting and fixed ergonomic handle configurations available to handle a wide variety of cargo
- Lift wheels are uni-directional to help prevent cargo from accidentally rolling down the stairs
- Dual speed control on all models to fit your application
- Electronic overload protection protects operating components if capacity is exceeded
- 10" pneumatic wheels
- Capacity: 375 lbs.
- Quick-change battery and charger included
- **Nose plates sold separately**



**Ergo Handle Type**



**Fold Handle Type**



**Uni Handle Type**



**Fold-L Handle Type**

**WESCO**

Model No.	Frame Type	Dimensions			Price /Each
		W"	x	H"	
MN247	Ergo	18 1/2	x	63	8849.00
MN248	Fold	18	x	61 (40 Folded)	9099.00
MN249	Uni	17 1/2	x	59	8769.00
MN250	Fold-L	19	x	64 1/2 (51 Folded)	9399.00

## NOSE PLATES

Model No.	Description	Dimensions			Price /Each
		W"	x	D"	
MN727	Grooved	16.5	x	13.4	588.00
MN728	Grooved	18.8	x	9.4	561.00
MN729	Smooth	18.45	x	10.9	529.00
MN730	Smooth	18.74	x	9.4	484.00
MN731	Smooth	17.7	x	7.5	488.00
MN732	Grooved	14	x	7	363.00
MN733	Grooved	23.25	x	7	525.00

**Note:** Each unit is capable of being customized with various options (i.e. wheel type and nose plate size). Also available in 240-lb. and 300-lb. capacities.

## NYLON MOVING STRAPS

- Allows for safe movement of appliances and larger items
- Movers can constantly stay in an upright position during the move, reducing the risk of back injuries
- Capacity: 5000 lbs.
- Includes two transport straps and two adjustable straps

**Model No. MD223**  
**Price/Each \$485.00**



# PLATFORM TRUCKS

## STEEL DECK PLATFORM TRUCKS

- Choose from the largest selection of platform size and casters to meet your application
- All-welded design 14-gauge steel base
- Two turned down lip and reinforced channels underneath
- Double welded sockets
- Removable 1 1/4" chrome handle can be inserted in either end
- Two swivel and two rigid bolted-on casters
- Shipped knocked-down
- Kleton blue powder coat finish



### 5" POLYOLEFIN CASTERS

- 900-lb. capacity evenly distributed

Model No.	Platform Size W" x L"	Deck Height"	Handle Height"	Wt. lbs.	Price /Each
MB238	24 x 36	8	36	61	345.00
MB246	24 x 48	8	36	74	395.00
MD427	30 x 48	8	36	80	455.00
MB254	30 x 60	8	36	94	525.00

#### REPLACEMENT PARTS & CASTERS

Model No.	Description	Price/Each
ML396	5" Rigid Polyolefin Caster	11.05
ML395	5" Swivel Polyolefin Caster	12.95
MB218	24" Chrome Handle	66.90
MB221	30" Chrome Handle	69.50



### 8" HIGH-TEMP NYLON CASTERS

- 1400-lb. capacity evenly distributed

Model No.	Platform Size W" x L"	Deck Height"	Handle Height"	Wt. lbs.	Price /Each
MB233	24 x 36	11	39	87	455.00
MB241	24 x 48	11	39	100	519.00
MD422	30 x 48	11	39	106	575.00
MB249	30 x 60	11	39	120	649.00

#### REPLACEMENT PARTS & CASTERS

Model No.	Description	Price/Each
ML865	8" Rigid High-Temp Nylon Caster	56.70
ML864	8" Swivel High-Temp Nylon Caster	67.35
MB218	24" Chrome Handle	66.90
MB221	30" Chrome Handle	69.50



### 5" NON-MARKING RUBBER CASTERS

- 1200-lb. capacity evenly distributed

Model No.	Platform Size W" x L"	Deck Height"	Handle Height"	Wt. lbs.	Price /Each
MB237	24 x 36	8	36	63	365.00
MB245	24 x 48	8	36	76	425.00
MD426	30 x 48	8	36	82	475.00
MB253	30 x 60	8	36	96	545.00

#### REPLACEMENT PARTS & CASTERS

Model No.	Description	Price/Each
ML338	5" Rigid Non-Marking Rubber Caster	24.05
ML337	5" Swivel Non-Marking Rubber Caster	26.10
MB218	24" Chrome Handle	66.90
MB221	30" Chrome Handle	69.50



### 8" MOLD-ON RUBBER CASTERS

- 1400-lb. capacity evenly distributed

Model No.	Platform Size W" x L"	Deck Height"	Handle Height"	Wt. lbs.	Price /Each
MB236	24 x 36	11	39	96	445.00
MB244	24 x 48	11	39	109	485.00
MD425	30 x 48	11	39	115	525.00
MB252	30 x 60	11	39	129	625.00

#### REPLACEMENT PARTS & CASTERS

Model No.	Description	Price/Each
ML853	8" Rigid Mold-On Rubber Caster	35.90
ML852	8" Swivel Mold-On Rubber Caster	43.40
MB218	24" Chrome Handle	66.90
MB221	30" Chrome Handle	69.50



### 6" HIGH-TEMP NYLON CASTERS

- 1300-lb. capacity evenly distributed

Model No.	Platform Size W" x L"	Deck Height"	Handle Height"	Wt. lbs.	Price /Each
MB232	24 x 36	9	37	77	395.00
MB240	24 x 48	9	37	90	459.00
MD421	30 x 48	9	37	96	509.00
MB248	30 x 60	9	37	110	585.00

#### REPLACEMENT PARTS & CASTERS

Model No.	Description	Price/Each
ML862	6" Rigid High-Temp Nylon Caster	42.60
ML861	6" Swivel High-Temp Nylon Caster	51.45
MB218	24" Chrome Handle	66.90
MB221	30" Chrome Handle	69.50



### 8" FULL PNEUMATIC CASTERS

- 1000-lb. capacity evenly distributed

Model No.	Platform Size W" x L"	Deck Height"	Handle Height"	Wt. lbs.	Price /Each
MB234	24 x 36	11	39	79	425.00
MB242	24 x 48	11	39	92	465.00
MD423	30 x 48	11	39	98	525.00
MB250	30 x 60	11	39	112	595.00

#### REPLACEMENT PARTS & CASTERS

Model No.	Description	Price/Each
MN221	8" Rigid Pneumatic Caster	30.95
MN222	8" Swivel Pneumatic Caster	35.95
MB218	24" Chrome Handle	66.90
MB221	30" Chrome Handle	69.50





## HEAVY-DUTY PLATFORM TRUCKS

- Steel deck made of a heavy-duty all-welded 11-gauge steel with reinforced channel formed deck
- Wood deck features a sturdy 2" x 2" angle iron frame with quality hardwood decking
- Removable 1 1/4" chrome handle can be placed at either end
- Double-welded sockets
- Available in standard caster or diamond tilt placement
- Various casters are available to meet your specific application
- Two rigid and two swivel bolted-on casters
- Durable Kleton blue enamel finish

**KLETON**

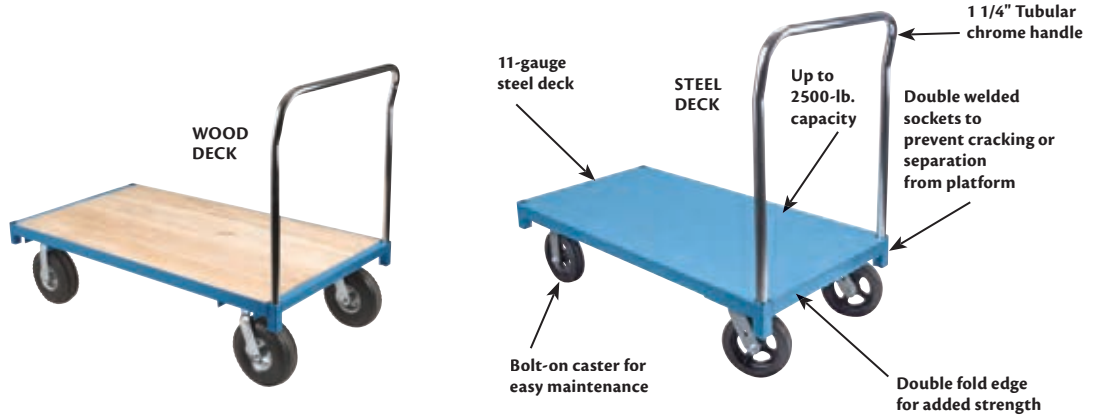

### 8" MOLD-ON RUBBER CASTERS

- 2000-lb. capacity evenly distributed

Platform Size"	Deck Height"	Handle Height"	Wood Deck						Steel Deck					
			Standard Corner	Wt. lbs.	Price /Each	Diamond Tilt	Wt. lbs.	Price /Each	Standard Corner	Wt. lbs.	Price /Each	Diamond Tilt	Wt. lbs.	Price /Each
24 x 48	11	40	MB296	110	749.00	MB298	115	785.00	MB295	110	655.00	MB297	120	719.00
30 x 48	11	40	MB304	125	845.00	MB306	130	835.00	MB303	125	675.00	MD331	135	745.00
30 x 60	11	40	MB308	140	879.00	MD332	145	909.00	MB307	140	725.00	MB309	150	795.00
36 x 72	11	40	MB320	180	1055.00	MB322	190	1109.00	MB319	180	845.00	MB321	195	925.00
48 x 96	11	40	MB324	240	2059.00	MB326	250	2115.00	MB323	240	1649.00	MB325	260	1795.00



### 8" HIGH-TEMP NYLON CASTERS

- 2500-lb. capacity evenly distributed

Platform Size"	Deck Height"	Handle Height"	Wood Deck						Steel Deck					
			Standard Corner	Wt. lbs.	Price /Each	Diamond Tilt	Wt. lbs.	Price /Each	Standard Corner	Wt. lbs.	Price /Each	Diamond Tilt	Wt. lbs.	Price /Each
24 x 48	11	40	MB130	110	769.00	MB133	115	809.00	MB131	110	665.00	MB132	120	735.00
30 x 48	11	40	MB138	125	805.00	MB141	130	839.00	MB139	125	685.00	MB140	135	759.00
30 x 60	11	40	MB142	140	895.00	MB145	145	915.00	MB143	140	735.00	MB144	150	785.00
36 x 72	11	40	MB155	180	1059.00	MB157	190	1165.00	MB154	180	849.00	MB156	195	925.00
48 x 96	11	40	MB166	240	1935.00	MB169	250	2115.00	MB167	240	1695.00	MB168	260	1895.00



### 10" FULL PNEUMATIC CASTERS

- 1200-lb. capacity evenly distributed

Platform Size"	Deck Height"	Handle Height"	Wood Deck						Steel Deck					
			Standard Corner	Wt. lbs.	Price /Each	Diamond Tilt	Wt. lbs.	Price /Each	Standard Corner	Wt. lbs.	Price /Each	Diamond Tilt	Wt. lbs.	Price /Each
24 x 48	13	42	MB256	110	895.00	MB258	115	905.00	MB255	110	739.00	MB257	120	815.00
30 x 48	13	42	MB264	125	975.00	MB266	130	999.00	MB263	125	785.00	MB265	135	865.00
30 x 60	13	42	MB267	140	1019.00	MB270	145	1045.00	MB268	140	839.00	MB269	150	925.00
36 x 72	13	42	MB279	180	1219.00	MB282	190	1309.00	MB280	180	985.00	MB281	195	1085.00
48 x 96	13	42	MB284	240	2209.00	MB286	250	2269.00	MB283	240	1849.00	MB285	260	1995.00



### CASTER PLACEMENT

- Standard corner pattern is 2 swivel casters in the back and 2 rigid casters in the front of the platform truck
- Diamond tilt pattern allows the truck to tilt-balance slightly on the centre side casters, allowing the truck to turn in its own length



Corner standard

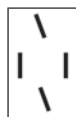

Diamond Tilt

### REPLACEMENT CASTERS

Model No.	Description	Price/Each
ML853	8" Rigid Mold-On Rubber Caster	35.90
ML852	8" Swivel Mold-On Rubber Caster	43.40
ML865	8" Rigid High-Temp Nylon Caster	56.70
ML864	8" Swivel High-Temp Nylon Caster	67.35
MN223	10" Pneumatic Rigid Caster	38.95
MN224	10" Pneumatic Swivel Caster	41.95

### REPLACEMENT HANDLES

Model No.	Description	Price/Each
MB218	24" Chrome Handle	66.90
MB221	30" Chrome Handle	69.50
MB224	36" Chrome Handle	92.50
MB226	48" Chrome Handle	105.00

# PLATFORM TRUCKS

## ERGONOMIC PLATFORM TRUCKS

- Ergonomic handle is placed at a comfortable working height to alleviate back strains
- Picking list holder eliminates the need to handle loose papers
- Deck is constructed from 14-gauge all welded steel with a turned down lip and reinforced channels
- Two swivel and two rigid 8" mold-on rubber casters
- 48" L x 24" W
- Capacity: 1200 lbs. evenly distributed
- Kleton powder coat finish

Model No. ML892  
Price/Each \$642.00



## ELEVATED PLATFORM TRUCKS

- All-welded steel construction, ready-to-use
- 11-gauge steel deck with 2" square tube frames
- 1 1/4" round tube handle extends 14" above deck
- Removable handle
- Durable Kleton blue enamel finish



Model No.	Platform Dimensions W" x D"	Deck Height	Wheel Type	Capacity lbs.	Price /Each
MN413	24 x 48	28	8" Hi-Temp Nylon	2000	829.00
MN414	30 x 60	28	8" Hi-Temp Nylon	2000	875.00
MN415	24 x 48	28	8" Mold-On Rubber	1800	819.00
MN416	30 x 60	28	8" Mold-On Rubber	1800	859.00
MN417	24 x 48	31	10" Pneumatic	1000	969.00
MN418	30 x 60	31	10" Pneumatic	1000	1035.00

## ALUMINUM PLATFORM TRUCKS

- 40% lighter on average, than steel or wood-and-steel platform trucks
- Corrosion resistant for extra long life
- Box frame made of high strength all-welded aluminum channel
- Corner sockets at both ends allow handles to be used on either end of the truck
- Rubber corner bumpers prevent damage to walls and furniture
- Wide variety of casters to suit any application
- Deck Type: Tread Plate

### 8" PNEUMATIC CASTERS

Model No.	Platform Dimensions"	Capacity lbs.	Wt. lbs.	Price /Each
ML904	24x36	1400	52	504.00
ML905	24x48	1400	57	540.00
ML906	30x60	1400	68	629.00

### 10" PNEUMATIC CASTERS

Model No.	Platform Dimensions"	Capacity lbs.	Wt. lbs.	Price /Each
ML910	24x36	1600	57	565.00
ML911	24x48	1600	62	604.00
ML912	30x60	1600	73	702.00

### 8" FLAT-FREE CASTERS

Model No.	Platform Dimensions"	Capacity lbs.	Wt. lbs.	Price /Each
ML916	24x36	1100	55	583.00
ML917	24x48	1100	60	624.00
ML918	30x60	1100	71	723.00

### 10" FLAT-FREE CASTERS

Model No.	Platform Dimensions"	Capacity lbs.	Wt. lbs.	Price /Each
ML922	24x36	1200	59	646.00
ML923	24x48	1200	64	693.00
ML924	30x60	1200	75	807.00

### 8" MOLD-ON RUBBER CASTERS

Model No.	Platform Dimensions"	Capacity lbs.	Wt. lbs.	Price /Each
ML928	24x36	2000	65	494.00
ML929	24x48	2000	70	528.00
ML930	30x60	2000	71	622.00

### 6" POLYURETHANE CASTERS

Model No.	Platform Dimensions"	Capacity lbs.	Wt. lbs.	Price /Each
ML934	24x36	3400	49	540.00
ML935	24x48	3400	54	583.00
ML936	30x60	3400	65	680.00

### 8" POLYURETHANE CASTERS

Model No.	Platform Dimensions"	Capacity lbs.	Wt. lbs.	Price /Each
ML940	24x36	4000	54	570.00
ML941	24x48	4000	59	605.00
ML942	30x60	4000	70	710.00



# PLATFORM TRUCKS

## SPECIALIZED PLATFORM DECKS

### SEMI LIVE SKIDS

- Ideal solution for removable temporary storage
- Heavy 11-gauge steel deck with reinforced channels
- 3/16" x 2" x 2" angle frame with hardwood deck
- 52" jack handle (sold separately) engages skids and converts them to portable truck
- Skids and handle roll on 8" Mold-On rubber wheels
- Can be stacked away when not in use
- 2000-lb. capacity evenly distributed
- Durable Kleton blue enamel finish



Model No.	Deck Size W" x L"	Deck Type	Deck Height"	Wt. lbs.	Price /Each
MB327	24 x 48	Steel	12	110	619.00
MB328	24 x 48	Wood	12	115	675.00
MB329	30 x 48	Steel	12	130	639.00
MB330	30 x 48	Wood	12	135	765.00
MB331	30 x 60	Steel	12	140	665.00
MB332	30 x 60	Wood	12	145	829.00
MB337	36 x 72	Steel	12	175	825.00
MB338	36 x 72	Wood	12	180	1025.00
MB348	51" long	Jack Handle	-	30	269.00

### REPLACEMENT CASTERS

Model No.	Description	Price/Each
ML853	8" Rigid Mold-On Rubber Caster	35.90



### DEAD SKIDS

- Tough and durable platforms for temporary storage and handling of material
- Heavy 11-gauge steel deck with reinforced channels
- 3/16" x 2" x 2" angle frame with hardwood deck
- Available with steel or hardwood decks
- Four sturdy steel legs keep loads off the floor
- Can be stacked when not in use
- 2500-lb. capacity evenly distributed
- Durable Kleton blue enamel finish



Model No.	Deck Dimensions W" x L"	Platform Type	Deck Height"	Wt. lbs.	Price /Each
ML071	24 x 48	Steel	12	110	659.00
ML072	24 x 48	Wood	12	115	775.00
ML073	30 x 48	Steel	12	130	679.00
ML074	30 x 48	Wood	12	135	829.00
ML075	30 x 60	Steel	12	140	705.00
ML076	30 x 60	Wood	12	145	899.00
ML077	36 x 72	Steel	12	175	875.00
ML078	36 x 72	Wood	12	180	1105.00

## PLATFORM TRUCKS

### ALL WOOD DECK PLATFORM TRUCKS

- Made of quality 7/8" hardwood with 5" x 1 5/8" hardwood sidewall
- Hardwood surface will not mar or scratch loads
- Removable 1 1/4" tubular chrome handle
- Mounted on two 12" wheels and two 6" swivel high-temp nylon casters
- 3000-lb. capacity evenly distributed



Model No.	Platform Size W" x L"	Deck Height"	Handle Height"	Wt. lbs.	Price /Each
MB122	24 x 48	15	44	150	1349.00
MB123	30 x 48	15	44	170	1355.00
MB124	30 x 60	15	44	195	1555.00
MB125	36 x 60	15	44	210	1635.00
MB126	36 x 72	15	44	230	1835.00

### REPLACEMENT PARTS & CASTERS

Model No.	Description	Price/Each
ML861	6" Swivel High-Temp Nylon Caster	51.45
MB218	24" Chrome Handle	66.90
MB221	30" Chrome Handle	69.50
MB224	36" Chrome Handle	92.50

### ERGONOMIC PLATFORM WAGON TRUCKS

- Flush deck allows for easy loading/unloading of cargo
- Steel deck made of an all-welded 11-gauge steel
- Quality hardwood deck features a 2" x 2" angle iron frame
- Handle can be raised up to 45"
- Fifth wheel design allows for easier manoeuvring
- T-handle with vinyl handgrips
- Rolls on four 10" pneumatic wheels
- 1000-lb. capacity evenly distributed
- Durable Kleton blue enamel finish



Steel Deck Model No.	Wt. lbs.	Price /Each	Wood Deck Model No.	Wt. lbs.	Price /Each	Size W" x L"	Platform Deck Height"
MD187	130	975.00	MD186	120	1079.00	24 x 48	14 1/4
MD189	170	1079.00	MD188	150	1215.00	30 x 60	14 1/4
MD193	210	1299.00	MD192	190	1539.00	36 x 72	14 1/4



# PLATFORM TRUCKS

## FOLDABLE PLATFORM TRUCKS

- Interlocking aluminum frame has a dual length platform: 16" x 20" or 16" x 28"
- Ideal when a solid, portable platform truck is required
- Folds down to a compact 9 1/2" x 16" x 20"
- Comes standard with vinyl corner bumpers
- Handle Height: 32"
- 4" rubber casters
- Capacity: 300 lbs. evenly distributed



**KLETON**

Model No.	Cap. lbs.	Wt. lbs.	Price /Each
MK990	300	18	165.00

## FOLDING HANDLE PLATFORM TRUCKS

- Move supplies, forms and light equipment around the shop or office
- Quick-release handle folds flat for easy storage
- Heavy-gauge steel construction; non-skid vinyl-coated deck
- 33" handle height
- Vinyl, wrap around bumper protects walls and furniture



**KLETON**

Model No.	Platform Size W" x D"	Cap. lbs.	Caster Type	Wt. lbs.	Price /Each
MK988	19 x 29	400	4" Rubber	28	135.00
MK989	23 x 35	660	5" Rubber	42	209.00

## HEAVY-DUTY PLATFORM TRUCKS

- Ideal for moving large and heavy loads
- Ergonomic handle design improves control and worker safety
- Powder-coated steel handle with retainer clips prevents unintended removal
- Steel reinforced deck for enhanced durability
- Molded-in-tie-down slots for load security
- Textured deck for enhanced durability
- Perimeter deck channel retains small items
- 2 fixed and 2 swivel casters
- Colour: Black
- Assembly required



ML565



Model No.	Overall Dimensions W" x L" x H"	Caster Type	Capacity lbs.	Wt. lbs.	Price /Each
ML565	24 x 36 x 40	6" Rubber	1000	58	1267.32
ML566	24 x 36 x 40	6" Polyolefin	2000	63	1328.42
ML567	24 x 48 x 42	8" Rubber	2000	76	1419.00
ML568	24 x 48 x 42	8" Pneumatic	1200	76	1605.00
ML569	24 x 48 x 42	8" Polyolefin	2500	80	1446.52
ML570	30 x 60 x 42	8" Rubber	2000	87	1623.42
ML572	30 x 60 x 42	8" Polyolefin	2500	100	1675.00

## PLASTIC PLATFORM TRUCKS

- HDPE-molded structural plastic for strength and long-term durability
- Lightweight, easy to clean, chemical resistant and resists damage from long-term exposure to weather conditions
- Non-skid deck surface
- Removable steel handle
- Other caster options and capacities available upon request
- Caster assembly required



MN428

**KLETON**

Model No.	Caster Type	Platform Size W" x L"	Deck Height"	Handle Height"	Capacity lbs.	Wt. lbs.	Price /Each
MN428	8" Mold-On Rubber	24 x 48	11	39	2000	90	1105.00
MN429	8" Mold-On Rubber	30 x 60	11	39	2000	117	1352.00
MN430	8" Polyurethane	24 x 48	11	39	2500	79	1118.00
MN431	8" Polyurethane	30 x 60	11	39	2500	106	1365.00
MN432	10" Pneumatic	24 x 48	13	41	1200	84	1114.00
MN433	10" Pneumatic	30 x 60	13	41	1200	111	1360.00
MN434	10" Flat-Free	24 x 48	13	41	1000	85	1169.00
MN435	10" Flat-Free	30 x 60	13	41	1000	117	1416.00
MN436	8" Pneumatic	24 x 48	11	39	1000	79	1097.00
MN437	8" Pneumatic	30 x 60	11	39	1000	106	1344.00
MN438	8" Flat-Free	24 x 48	11	39	900	80	1131.00
MN439	8" Flat-Free	30 x 60	11	39	900	107	1378.00

## INSTITUTIONAL PLATFORM TRUCKS

- Ideal truck for institutional applications - hospitals, restaurants, shopping centres, offices, industry and anywhere else a quiet ride and professional appearance is required
- 14-gauge steel deck with 2" lip underneath
- Non-skid rubber surface means product will not shift during use
- Rubber corner bumpers protect walls and furniture
- 1 1/4" tubular chrome handle with end panel contains small packages
- 5" non-marking rubber casters for a smooth, quiet ride; two rigid/two swivel
- 1200-lb. capacity evenly distributed
- Shipped knocked down



Chrome Handle!

**KLETON**

Model No.	Dimensions L" x W"	Wt. lbs.	Price /Each
MB190	36 x 24	64	735.00
MB208	48 x 24	70	759.00
MB207	48 x 30	88	955.00
MB209	60 x 30	100	975.00



## FOLDING ERGO-HANDLE PLATFORM TRUCK

- Deck Width: 24"
- Deck Length: 35-1/2"
- Handle Height: 41"
- Capacity: 660 lbs.
- Wheel Material: Mold-on Rubber
- Deck Type: Tread Plate
- Corner bumpers
- Ergonomic European style handle
- Includes (2) 7" swivel (2) 7" rigid casters

Model No. MO097  
Price/Each \$514.00



**WESCO**

## WOOD DECK/STEEL FRAME U-BOATS

- Removable handles
- 2 rigid center casters and 4 swivel end casters allow trucks to turn on their own radius
- Provides easy maneuverability in narrow aisles and confined areas
- Handle Height: 60"
- Caster Placement: Corner Standard



Model No.	Mfg. No.	Deck Width"	Deck Length"	Capacity lbs.	Wheel Diameter"	Wheel Material	Price /Each
MO128	273294	16	60	1750	8	Mold-On Rubber	673.00

## TRIPLE™ TROLLEYS

- Three position handle lets users push, pull or fold flat for space efficient storage
- Non-skid surface helps prevent load shifting
- Durable, structural foam deck won't rust, dent or bend
- 5" mark resistant casters give stability over rough surfaces
- Colour: Black



Model No.	Description	Size W" x L" x H"	Cap. lbs.	Wt. lbs.	Price /Each
MH708	Standard Trolley	20 1/2 x 32 1/2 x 37 3/4	500	25	444.08

## ALUMINUM U-BOAT PLATFORM TRUCKS

- Removable handles
- 2 rigid center casters and 4 swivel end casters allow trucks to turn on their own radius
- Provides easy maneuverability in narrow aisles and confined areas
- Open deck design
- Deck Width: 16"
- Deck Length: 63"
- Handle Height: 61"
- Capacity: 1322 lbs.
- Caster Placement: Corner Standard
- Wheel Diameter: 5"
- Wheel Material: Polyurethane
- Deck Type: Smooth



Model No. MO195  
Mfg. No. 270339  
Price/Each \$949.00



## TOWABLE CARTS

- Easily tow up to 3 carts at once with a towing vehicle using the heavy-duty tow bar and hitch
- Compatible with all standard wooden and plastic pallets up to a standard 48" x 48" pallet
- Features a precision-engineered Duramold™ Deck constructed of resin and metal composite that is lighter than typical steel/wood products without sacrificing strength
- Patented handle designed with variable grip heights to suit a wide range of user heights when used manually with up to two products
- Textured deck surface reduces load slippage
- Assembly required
- Handle Height: 42.5"
- Capacity: 2500 lbs.
- Wheel Diameter: 8"
- Wheel Type: Polyolefin
- Deck Height: 12-3/8"
- Frame Material: Powder-Coated Steel
- Colour: Black



Model No.	Mfg. No.	Description	Deck Width"	Deck Length"	Cart Weight	Price /Each
MP735	2154626	Towable Pallet Cart	51	54-1/2	148.5 lbs. (67.36 kg)	2638.00
MP736*	2154629	Towable Platform Cart	30-1/2	64-1/4	91.5 lbs. (41.5 kg)	2262.00

\* Four in molded tie-down slots allow users to secure loads with tie-down straps or bungees when transporting loads

## ADJUSTABLE WOOD DECK PLATFORM TRUCK

- Features 2 rigid and 2 swivel casters
- Tubular offset handle allows easy mobility
- Removable handle
- Ships fully assembled
- Treated hardwood surface
- Deck Width: 24"
- Deck Length: 48"
- Capacity: 1800 lbs.
- Caster Placement: Corner Standard
- Wheel Diameter: 8"
- Wheel Material: Mold-on Rubber
- Overall Dimensions: 24" W x 51-3/4" D x 49-1/4" H
- Wheel Width: 2"
- Finish: Textured Powder Coated
- Frame Material: 14 Gauge Steel



Model No. MP759  
Mfg. No. WHPTA-WD-2448-8MR-95  
Price/Each \$1389.00



## TROLLEYS

- Durable construction resistant to chipping and peeling
- Three convenient handle positions: up, 45° angle and folded down
- 5" casters are resistant to marking
- Deck Width 20-1/2"
- Deck Length 31-3/4"
- Handle Height: 27"
- Capacity: 500 lbs.
- Wheel Diameter: 5"
- Wheel Type: Rubber
- Deck Height: 6"

Model No. JH489  
Price/Each \$199.00



# PANEL TRUCKS

## DRYWALL CARTS

- All-welded multi-purpose cart is ideal for transporting drywall, wood or metal sheets
- 1 1/4" tubular rail handle and thick 11-gauge steel platform
- Two rigid and two swivel 8" bolted-on casters
- Deck Dimensions: 15" W x 44" L x 14" H
- Overall Dimensions: 24" W x 44" L x 44" H
- Deck angle: 80°
- Kleton blue enamel finish



Model No.	Cap. lbs.	Caster Type	Wt. lbs.	Price /Each
ML139	2000	8" Mold-on Rubber	98	689.00
MD214	3500	8" Polyurethane	97	705.00

## LUMBER CARTS

- All-welded cart is ideal for transporting long and bulky items
- Welded 14-gauge 12" x 38" steel shelf
- Grey rubber bumpers protect walls and equipment
- Two rigid and two swivel bolted-on casters
- Kleton blue enamel finish
- 1200-lb. capacity evenly distributed



Model No.	Deck Size W" x L" x H"	Shelf Height"	Overall Size W" x L" x H"	Caster Type	Wt. lbs.	Price /Each
MB729	24 x 36 x 8	34	26 x 39 x 42	5" Rubber	79	845.00
ML140	24 x 36 x 10	36	26 x 39 x 45	6" Rubber	102	1090.00

## BUILDMAN™ H-CART MULTI-USE DRYWALL CART

- Multiple configurations
- Removable handles & storage holders
- 8" heavy duty non-marking casters
- Can carry up to 25 gypsum boards of 1/2"
- Heavy-Duty construction for intensive use
- Capacity: 3000 lbs.
- Cart Material: Steel
- Overall Dim: 48-1/4" W x 50" D x 27-3/4" H
- Deck Dimensions: 27-1/4" W x 50" L

Model No. MP910  
Mfg. No. I-BMDHER31YGR  
Price/Each \$555.00



## H-CART CONNECTOR

Model No. MP926  
Mfg. No. I-BMDHBR  
Price/Each \$85.90

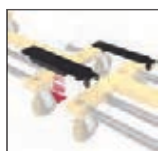

MP926



## U-BOAT PLATFORM TRUCKS

- Tilt design allows truck to turn within its own radius
- 11-gauge steel deck is only 10" off the ground for easy loading
- Removable end racks constructed of 1 1/4" round steel tube
- Two 8" x 2" bolted-on rigid casters and four 5" swivel casters
- Capacity: 1500 lbs. evenly distributed
- Durable Kleton blue enamel finish



Model No.	Overall Dimensions			Wt. lbs.	Price /Each
	W"	x	D" x H"		
MK970	18	x	48 x 72	125	799.00
MK971	18	x	60 x 72	80	829.00

## GALVANIZED STEEL U-BOAT PLATFORM TRUCKS

- Removable handles
- 2 rigid center casters and 4 swivel end casters allow trucks to turn on their own radius
- Provides easy maneuverability in narrow aisles and confined areas
- Capacity: 1750 lbs.
- Wheel Material: Polyurethane



Model No.	Deck Width"	Deck Length"	Overall Height"	Price /Each
MO092	16	60	60	825.00
MO093	18	60	60	742.00
MO094	24	60	60	1109.00

## SIDE PANEL PLATFORM TRUCKS

- Ideal for transporting and retaining small packages and materials
- Ergonomic handle design improves control and worker safety
- Side panels easily remove to accommodate oversize loads
- Side panel cut outs allows for ergonomic access of contents
- Steel reinforced deck for enhanced durability
- Molded-in tie-down slots for load security
- Textured deck surface reduces load slippage
- Perimeter deck channel retains small items
- Heavy-duty steel wire panels with 3" x 3" grid
- 2 fixed and 2 swivel casters
- Colour: Black
- Assembly required



Model No.	Overall Dimensions W" x L" x H"	Caster Type	Capacity lbs.	Wt. lbs.	Price /Each
ML608	24 x 48 x 41	8" Rubber	2000	105	2125.00

## HORIZONTAL PANEL CART

- Two tier cart is great for handling panels and small items
- The top dock is 40-15/16" high while the bottom dock is 11-2/3" off the ground
- Four sliding posts can be locked in the up position to prevent products from sliding
- Rolls on (4) 5" x 1-1/2" swivel and (2) 8" x 2" rigid casters
- Overall Base Size: 28-1/2" W x 54" L x 11-2/3" H
- Overall Height: 40-15/16"
- Overall Length: 63-7/16"
- Overall Width: 28-1/2"
- Capacity: 2000 lbs.

Model No. MO515  
Price/Each \$1375.00





## KNOCKED-DOWN PANEL TRUCK

- Move tables, drywall, plywood, tables, artwork at ease
- Move light to heavy duty objects at ease with (4) 5" non-marking blue elastic swivel casters
- Removable upright panel bars fit any size load
- Ships knocked-down for freight savings and damage avoidance
- Capacity is based on evenly distributed weight
- Overall Height: 43"
- Overall Length: 30"
- Overall Width: 27"
- Capacity: 1000 lbs.
- Wheel Diameter: 5"
- Wheel Material: Rubber

**Model No. MO522** - Open-Deck  
**Price/Each \$445.00**

**Model No. MO523** - Carpet-Deck  
**Price/Each \$565.00**



MO523

## SINGLE LEVEL RAILS HEAVY-DUTY PANEL MOVER TRUCKS

- Ideal for transporting large sheets and long parts
- All-welded construction made from 1 1/4" round tubing and reinforced 11-gauge deck
- Uprights extend 33" above deck
- Deck is 12" off the floor
- Overall Height is 45"
- 8" clear space between tubes
- Two swivel and two rigid 8" casters
- Capacity is based on evenly distributed weight
- Durable Kleton blue enamel finish



ML549

Model No.	Overall Dimensions W" x D" x H"	Caster Type	Capacity lbs.	Wt. lbs.	Price /Each
ML549	30 x 48 x 45	8" Mold-On Rubber	2000	139	979.00
ML550	30 x 48 x 45	8" Polyurethane	2500	139	1095.00
ML551	30 x 60 x 45	8" Mold-On Rubber	2000	161	1029.00
ML552	30 x 60 x 45	8" Polyurethane	2500	161	1285.00

## FLAT BED LUMBER CARTS

- All-welded cart is ideal for transporting large panel or sheets in a horizontal position
- Four 6" swivel and two 6" rigid bolted-on non-marking polyurethane casters
- Durable Kleton blue enamel finish

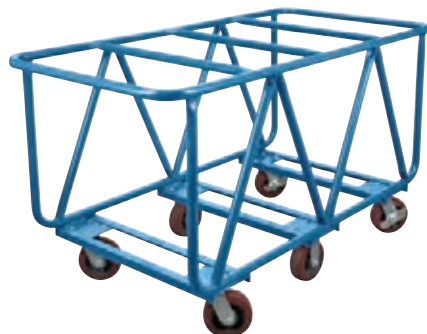

Model No.	Overall Dimensions W" x L" x H"	Wt. lbs.	Capacity lbs.	Price /Each
ML141	30 x 60 x 33	160	2500	1165.00

## BUILDMAN™ DRYWALL PANEL HOIST



- Last longer for heavy use
- No cable tangle
- Three 6" double lock heavy-duty swivel casters
- Cradle tilts for sloped ceiling or vertical wall installations – 37" loading height
- Fast action single stage winch with silent cam lock brake
- Multi-stage chain mechanism
- Capacity: 200 lbs.
- Overall Dim: 60-1/4" W x 48-3/4" D x 58-1/4" H
- Lift: 14'5"

**Model No. MP912**  
**Mfg. No. I-BMDPL**  
**Price/Each \$1325.00**



## HEAVY-DUTY PANEL MOVER TRUCKS

- Ideal for transporting of large sheets and long parts
- All-welded construction made from a 1 1/4" round tubing and 11-gauge deck
- Uprights extend 21" and 33" above deck
- Deck is 12" off the floor
- 8" clear space between tubes
- Two swivel and two rigid 8" casters
- Capacity is based on evenly distributed weight
- Durable Kleton blue enamel finish



ML360

Model No.	Overall Dimensions W" x D" x H"	Caster Type	Capacity lbs.	Wt. lbs.	Price /Each
ML360	30 x 48 x 45	Mold-On Rubber	2000	160	1029.00
ML361	30 x 48 x 45	Polyurethane	2500	175	1209.00
ML362	30 x 60 x 45	Mold-On Rubber	2000	160	1085.00
ML363	30 x 60 x 45	Polyurethane	2500	175	1275.00

## A-FRAME SHEET/PANEL TRUCKS

- Ideal for handling long, flat, awkward loads
- Frame is constructed of all-welded 2" angle
- Available with open or closed base
- Four bolted-on 5" non-marking rubber swivel casters
- Durable Kleton blue enamel finish
- 1200-lb. capacity evenly distributed

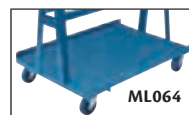

ML064



MD217

Model No.	Overall Dimensions W" x L" x H"	Base Type	Wt. lbs.	Price /Each
MD216	24 x 36 x 55	Open	50	565.00
ML063	24 x 36 x 55	Closed	60	725.00
MD217	30 x 42 x 55	Open	79	585.00
ML064	30 x 42 x 55	Closed	75	749.00
MD218	36 x 72 x 55	Open	85	715.00
ML065	36 x 72 x 55	Closed	110	989.00

# CARTS

## MOBILE PIPE & BAR RACKS

- All-welded steel construction, ready to use
- 3 double sided storage levels with 7" high uprights to secure load
- Useable space per side 6"-11"-15" (top-middle-bottom)
- Capacity: 3000 lbs.
- Cart Material: Steel
- Wheel Material: Polyurethane
- Durable Kleton blue enamel finish
- Capacity is based on evenly distributed weight



Model No.	Dimensions					Price /Each
	W"	x	D"	x	H"	
MO248	48	x	36	x	60	1115.00
MO249	72	x	36	x	60	1205.00

## BAR CRADLE TRUCKS

- Designed for efficient handling of long material
- Tilt design allows truck to turn within its own radius
- Cradle design facilitates loading and unloading
- Two 12" phenolic wheels and four 6" swivel phenolic bolt-on casters
- Capacity: 5000 lbs.
- Durable Kleton blue enamel finish



Model No.	Overall Dimensions				No. of Cradles	Wt. lbs.	Price /Each
	W"	x	D"	x			
ML128	28	x	60	x	29	215	1895.00
ML130	28	x	96	x	29	300	2225.00
ML131	28	x	120	x	29	365	2679.00

## A-FRAME BAR & PIPE CART

- Ideal for storage and transporting pipe, conduit and other types of bar material
- Storage arms extend 12" beyond frame with a clearance of 71/4" between arms
- Unit rolls on (2) rigid and (2) swivel 5" poly-on-steel casters with brakes
- Storage rack is 72-1/2"H with 8 storage levels
- Capacity: 2000 lbs.
- Cart Material: Steel
- Overall Width: 36-3/4"
- Overall Height: 72-1/2"
- Overall Depth: 73-3/4"
- Construction: Knocked Down



Model No.	Price /Each
MO514	1249.00

## PIPE & BAR CRADLE TRUCKS

- All-welded steel construction, ready to use
- Raised ergonomic bed height of 20" is ideal for shop environment
- Cradle is 19-1/2"W x 14"H
- 6" heavy-duty swivel casters allow for greater maneuverability in tight spaces and can turn on their axes
- Single units are ideal for shorter loads and must be centered on the truck; multiple units can be combined for greater capacity and to support longer loads
- Recessed side decks allow for loading and unloading with a lift truck
- Durable Kleton blue enamel finish
- Capacity: 2500 lbs.
- Wheel Material: Polyurethane



Model No.	Overall Dimensions			Wt. lbs.	Price /Each		
	W"	D"	H"				
MP037	24	x	24	x	34	93	589.00
MP038	36	x	24	x	34	104	629.00
MP039	48	x	24	x	34	113	675.00

KLETON

CANADA'S LEADING  
MATERIAL HANDLING  
SUPPLIER

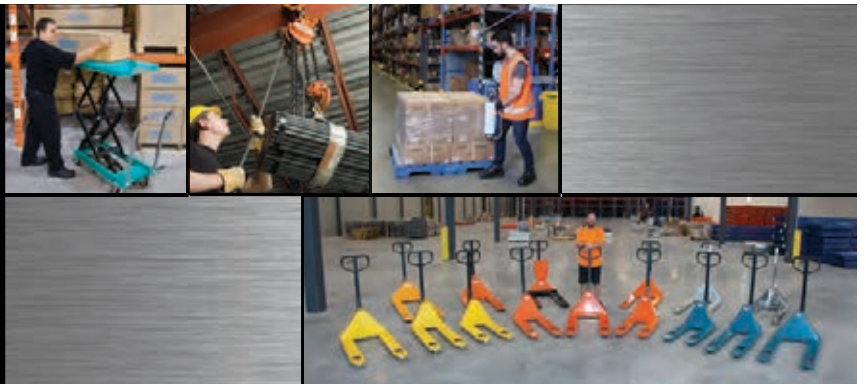

## STAINLESS STEEL SHELF CARTS

- 430 stainless steel shelves and frame construction
- NSF approved
- 4 swivel, zinc plated casters with non-marking rubber tread, polyurethane hub wheels
- Top and centre shelf include a 3 sided 1" lip
- Bottom shelf is flat with no lip
- Protection bumpers on legs and handles
- Shelves have reinforced hemmed front
- Overall capacity based upon evenly distributed weight
- Number of Shelves: 3
- Construction: All-welded
- Wheel Material: Rubber



MO251



MO254

Model No.	Distance Between Shelves"	Caster Size"	Dimensions W" x D" x H"	Load Capacity per Shelf lbs.	Capacity lbs.	Price /Each
MO250	12-3/4 (Top & Bottom)	3-1/2	15-1/2 x 24 x 32-1/8	100	300	820.00
MO251	13-1/4 (Top & Bottom)	3-1/2	17-5/8 x 27-1/8 x 33	100	300	602.00
MO252	12-1/2 (Top)/14-5/8 (Bottom)	4	15-3/4 x 24 x 32	166	500	639.00
MO253	13 (Top)/14-1/2 (Bottom)	4	18 x 27-3/8 x 32	166	500	1059.00
MO254	14-3/8 (Top)/14-1/2 (Bottom)	5	21 x 35-1/8 x 37-1/4	166	500	1239.00

## INDUSTRIAL GRADE SHELF CART

- Features a sturdy tubular push handle
- Four 6" x 2" polyurethane casters; 2 rigid and 2 swivel
- Overall dimensions includes handle
- Made from industrial, 16 gauge stainless steel
- All 1-1/2" lip
- Cart Material: Stainless Steel
- Construction: All-Welded
- Lip Configuration: Lip Up
- Wheel Material: Polyurethane
- Capacity: 1200 lbs.



MO974

## INDUSTRIAL GRADE SHELF CART

- Features a sturdy tubular push handle
- Four 5" x 1-1/4" polyurethane casters; 2 rigid and 2 swivel with side brakes
- All 1-1/2" lip up except in the front
- Overall dimensions includes handle
- Made from industrial, 16 gauge stainless steel
- Cart Material: Stainless Steel
- Construction: All-Welded
- Lip Configuration: Lip Up
- Wheel Material: Polyurethane
- Capacity: 1200 lbs.



MO976

**DURHAM MFG**  
Est. 1922

**DURHAM MFG**  
Est. 1922

Model No.	Mfg. No.	No. of Shelves	Overall Dimensions W" x D" x H"	Weight lbs.	Price /Each
MO967	SRSC1624362ALU6PU	2	24-1/8 x 42 x 36	97	1229.00
MO974	SRSC1618363ALU6PU	3	18-1/8 x 42 x 47	101	1295.00
MO972	SRSC1618304ALU6PU	4	18-1/8 x 53 x 36	107	1349.00
MO980	SRSC1624484ALU6PU	4	24-1/8 x 53 x 54	154	1789.00

Model No.	Mfg. No.	No. of Shelves	Overall Dimensions W x D x H	Weight lbs.	Price /Each
MO976	SRSC1624362FLD5PU	2	24-1/8 x 42 x 35	86	965.00
MO979	SRSC1624482FLD5PU	2	24-1/8 x 54 x 35	95	1075.00
MO969	SRSC1618242FLD5PU	3	18-1/8 x 30 x 35	52	749.00
MO979	SRSC1624482FLD5PU	2	24-1/8 x 54 x 35	95	1075.00
MO971	SRSC1618303FLD5PU	3	18-1/8 x 36 x 35	83	955.00
MO977	SRSC1624363FLD5PU	3	24-1/8 x 42 x 35	103	1175.00
MO982	SRSC1630603FLD5PU	3	30-1/8 x 66 x 35	155	1655.00



**RMP**  
PRODUITS D'ENTRETIEN - MAINTENANCE PRODUCTS



# CARTS



## HEAVY-DUTY SHELF TRUCKS

- Durable Kleton blue enamel finish



## HEAVY-DUTY SHELF CARTS

- All-welded ready to use
- Versatile for all material transport
- Cart constructed from 14-gauge steel shelves welded to 1 1/2" x 1 1/2" x 1/8" steel angle posts
- 1" diameter tubular steel handle
- Shelves are available with a 1 1/2" lip configured up or down
- 2 rigid and 2 swivel bolted-on 5" non-marking casters
- Capacity: 1200 lbs. evenly distributed
- Durable Kleton blue enamel finish



Lip Up Model No.	Lip Down Model No.	Shelf Size		No. Shelves	Clearance Between Shelves"	Handle Height"	Overall Dimensions				Wt. lbs.	Price /Each	
		W"	D"				W"	x	D"	x			H"
<b>36" OVERALL HEIGHT</b>													
MB445	MB444	18	x 30	2	27	36	18	x	33	x	36	60	455.00
MB447	MB446	24	x 36	2	27	36	24	x	39	x	36	65	495.00
MB449	MB448	24	x 48	2	27	36	24	x	51	x	36	100	549.00
MB456	MB455	18	x 30	3	12	36	18	x	33	x	36	75	515.00
MB459	MB458	24	x 36	3	12	36	24	x	39	x	36	85	575.00
MB461	MB460	24	x 48	3	12	36	24	x	51	x	36	110	625.00
<b>48" OVERALL HEIGHT</b>													
ML084	ML083	18	x 30	3	18	42	18	x	33	x	48	80	595.00
ML086	ML085	24	x 36	3	18	42	24	x	39	x	48	90	675.00
ML088	ML087	24	x 48	3	18	42	24	x	51	x	48	115	695.00
ML090	ML089	18	x 30	4	12	42	18	x	33	x	48	110	745.00
ML092	ML091	24	x 36	4	12	42	24	x	39	x	48	135	835.00
ML094	ML093	24	x 48	4	12	42	24	x	51	x	48	160	885.00
<b>61" OVERALL HEIGHT</b>													
MB468	MB467	18	x 30	4	16	42	18	x	33	x	61	115	715.00
MB470	MB469	24	x 36	4	16	42	24	x	39	x	61	140	765.00
MB472	MB471	24	x 48	4	16	42	24	x	51	x	61	165	835.00
MB474	MB473	18	x 30	5	11	42	18	x	33	x	61	125	795.00
MB476	MB475	24	x 36	5	11	42	24	x	39	x	61	155	895.00
MB478	MB477	24	x 48	5	11	42	24	x	51	x	61	184	935.00

### REPLACEMENT CASTERS/PARTS

Model No.	Description	Price /Each
ML338	5" Rigid Non-Marking Rubber Casters	24.05
ML337	5" Swivel Non-Marking Rubber Casters	26.10
MC043	Corner Bumpers	5.95

Note: Other casters available upon request



ML338



ML337



MC043

## KNOCKED-DOWN SHELF TRUCKS

- 16-gauge steel shelves with 2 1/2" high lip
- 1 1/2" x 1 1/2" x 12-gauge formed steel posts
- 1 1/4" diameter tubular steel handle
- Top and middle shelves can be installed lip up or down
- Two rigid and two swivel bolted-on casters
- Easy-to-assemble shipped knocked-down design
- Capacity: 900 lbs. evenly distributed
- Durable Kleton blue powder coat finish

KLETON



MB492



ML146



ML151



MB496

### 2-SHELF UTILITY CARTS

Model No.	Shelf Dim. W" x D"	Shelf Clearance"	Post Height"	Overall Height"	Weight lbs.	Price /Each
<b>5" BLUE ELASTIC RUBBER CASTERS</b>						
MB492	18 x 30	25	30	36	52	249.00
MB493	24 x 36	25	30	36	67	299.00
MB494	24 x 48	25	30	36	78	329.00
<b>5" POLYOLEFIN CASTERS</b>						
MB482	18 x 30	25	30	36	48	239.00
MB483	24 x 36	25	30	36	63	289.00
MB484	24 x 48	25	30	36	74	319.00
<b>8" PNEUMATIC CASTERS</b>						
MB488	24 x 36	25	30	40	80	379.00
MB489	24 x 48	25	30	40	91	419.00

### 4-SHELF UTILITY CARTS

Model No.	Shelf Dim. W" x D"	Shelf Clearance"	Post Height"	Overall Height"	Weight lbs.	Price /Each
<b>5" BLUE ELASTIC RUBBER CASTERS</b>						
ML145	18 x 30	10	42	48	87	409.00
ML146	24 x 36	10	42	48	117	515.00
ML147	24 x 48	10	42	48	140	578.00
ML148	18 x 30	15	55	61	93	425.00
ML149	24 x 36	15	55	61	123	525.00
ML150	24 x 48	15	55	61	146	595.00
<b>5" POLYOLEFIN CASTERS</b>						
MN148	18 x 30	10	42	48	84	369.00
MN149	24 x 36	10	42	48	114	489.00
MN150	24 x 48	10	42	48	137	575.00
MN151	18 x 30	15	55	61	89	389.00
MN152	24 x 36	15	55	61	120	499.00
MN153	24 x 48	15	55	61	143	595.00
<b>8" PNEUMATIC CASTERS</b>						
MN154	24 x 36	10	42	52	130	585.00
MN155	24 x 48	10	42	52	154	685.00
MN156	24 x 36	15	55	65	136	599.00
MN157	24 x 48	15	55	65	159	709.00

### 3-SHELF UTILITY CARTS

Model No.	Shelf Dim. W" x D"	Shelf Clearance"	Post Height"	Overall Height"	Weight lbs.	Price /Each
<b>5" BLUE ELASTIC RUBBER CASTERS</b>						
MB495	18 x 30	11	30	36	67	309.00
MB496	24 x 36	11	30	36	89	409.00
MB497	24 x 48	11	30	36	106	445.00
ML142	18 x 30	17	42	48	73	355.00
ML143	24 x 36	17	42	48	95	409.00
ML144	24 x 48	17	42	48	112	465.00
<b>5" POLYOLEFIN CASTERS</b>						
MB485	18 x 30	11	30	36	63	289.00
MB486	24 x 36	11	30	36	86	369.00
MB487	24 x 48	11	30	36	103	425.00
MN143	18 x 30	17	42	48	69	325.00
MN144	24 x 36	17	42	48	92	389.00
MN145	24 x 48	17	42	48	109	439.00
<b>8" PNEUMATIC CASTERS</b>						
MB490	24 x 36	11	30	40	102	449.00
MB491	24 x 48	11	30	40	119	509.00
MN146	24 x 36	17	42	52	108	499.00
MN147	24 x 48	17	42	52	125	549.00

### 5-SHELF UTILITY CARTS

Model No.	Shelf Dim. W" x D"	Shelf Clearance"	Post Height"	Overall Height"	Weight lbs.	Price /Each
<b>5" BLUE ELASTIC RUBBER CASTERS</b>						
ML151	18 x 30	10	55	61	107	489.00
ML152	24 x 36	10	55	61	145	655.00
ML153	24 x 48	10	55	61	175	715.00
<b>5" POLYOLEFIN CASTERS</b>						
MN158	18 x 30	10	55	61	104	449.00
MN159	24 x 36	10	55	61	142	595.00
MN160	24 x 48	10	55	61	171	689.00
<b>8" PNEUMATIC CASTERS</b>						
MN161	24 x 36	10	55	65	158	685.00
MN162	24 x 48	10	55	65	188	779.00



## HEAVY-DUTY LOW PROFILE SHOP CARTS

- All-welded cart with low shelf means less distance to lift heavy objects
- Two 14-gauge steel shelves with a 1 1/2" lip down
- 1 1/4" diameter tubular steel handle
- Two rigid and two swivel bolted-on casters
- Durable Kleton blue enamel finish

### 5" RUBBER CASTERS

- Non-marking casters are quiet rolling and ideal for both institutional and industrial applications
- Casters are resistant to wet and corrosive chemical conditions
- Clearance Between Shelves: 16"
- Handle Height: 40"
- Top Shelf Height: 26"
- Capacity: 1200 lbs. evenly distributed



MB425

Model No.	Shelf Size W" x D"	Overall Dimensions W" x D" x H"	Wt. lbs.	Price /Each
MB421	18 x 30	18 x 34 x 40	90	555.00
MB425	24 x 36	24 x 40 x 40	110	589.00
MB429	24 x 48	24 x 52 x 40	125	665.00
ML097	24 x 60	24 x 64 x 40	155	839.00
ML098	30 x 48	30 x 52 x 40	155	955.00
MB434	30 x 60	30 x 64 x 40	165	915.00
ML099	30 x 72	30 x 76 x 40	175	1205.00

KLETON



### 6" HI-TEMP NYLON OR POLYURETHANE CASTERS

- Solid black hi-temp nylon casters handle heavy loads easily
- Solid polyurethane casters are non-marking and are highly resistant to wear
- Best choice in uneven floor applications
- Clearance between shelves: 16"
- Handle Height: 41"
- Top Shelf Height: 27"
- Capacity: 2400 lbs. evenly distributed



MB426

6" Nylon Model No.	Price /Each	6" Polyurethane Model No.	Price /Each	Shelf Size W" x D"	Overall Dimensions W" x D" x H"	Wt. lbs.
MB422	789.00	ML103	975.00	18 x 30	18 x 34 x 41	100
MB426	835.00	ML104	1039.00	24 x 36	24 x 40 x 41	130
MB430	915.00	ML105	1149.00	24 x 48	24 x 52 x 41	145
ML100	1109.00	ML106	1189.00	24 x 60	24 x 64 x 41	155
ML101	1249.00	ML107	1215.00	30 x 48	30 x 52 x 41	155
MB435	1195.00	ML108	1535.00	30 x 60	30 x 64 x 41	165
ML102	1535.00	ML109	1619.00	30 x 72	30 x 76 x 41	175

## SHELF & PLATFORM TRUCKS

- An efficient 2-in-1 shelf and platform truck design
- Features two front corner bumpers and a removable 11-gauge top shelf to convert to a platform truck
- Two rigid and two swivel bolted-on 5" non-marking rubber casters
- Shelf Clearance: 24"
- Handle Height: 40"
- Top Shelf Height: 32"
- Capacity: 1300 lbs., 500 lbs. top shelf/800 lbs. bottom shelf evenly distributed
- Durable Kleton blue enamel finish



Model No.	Shelf Size W" x D"	Overall Dimensions W" x D" x H"	Wt. lbs.	Price /Each
MB391	24 x 36	26 x 38 x 40	105	640.00

## DEEP-LIPPED SERVICE CARTS

- All-welded design, ready-to-use
- Deep shelf lips for retention
- Two 14-gauge steel shelves welded to 1 1/2" x 1 1/2" x 1/8" steel posts
- 1" diameter tubular ergonomic handle
- Two rigid and two swivel 5" non-marking rubber casters
- Overall Dimensions: 24" W x 42" D x 47" H
- Capacity: 1200 lbs. evenly distributed
- Durable Kleton blue enamel finish



MN393



Model No.	Shelf Size W" x D"	Shelf Lip Depth	Clearance Between Shelves	Wt. lbs.	Price /Each
MN393	24 x 36	Top 6"/Bottom 1 1/2"	22 1/2"	85	715.00
MN394	24 x 36	Top 12"/Bottom 1 1/2"	16	90	739.00
MN395	24 x 36	Top 6"/Bottom 6"	18	90	765.00

## ERGONOMIC SHELF TRUCKS

- All-welded 16-gauge construction ready to use
- All-welded ergonomic handle placed at a comfortable working height
- Two rigid and two swivel 5" casters
- Durable Kleton blue enamel finish
- 800-lb. capacity evenly distributed



ML561



Model No.	Number of Shelves	Caster Type	Overall Dimensions W" x D" x H"	Price /Each
ML561	2	Blue Rubber	20 x 32 x 37	405.00
MN056	2	Blue Rubber	26 x 38 x 37	489.00
ML562	3	Blue Rubber	20 x 32 x 37	441.00
MN055	3	Blue Rubber	26 x 38 x 37	589.00
ML563	2	Polyolefin	20 x 32 x 37	363.00
ML883	2	Polyolefin	26 x 38 x 37	449.00
ML564	3	Polyolefin	20 x 32 x 37	407.00
ML884	3	Polyolefin	26 x 38 x 37	537.00



## MOBILE SERVICE CARTS

- All welded design, ready to use
- Lockable drawer for supplies
- Two 14 gauge steel shelves welded to 1 1/2" x 1 1/2" x 1/8" steel posts
- 1" diameter tubular handle
- Two rigid and two swivel with brake bolted-on 5" non-marking rubber casters
- Durable Kleton blue enamel finish
- No. of Shelves: 2
- Overall Dim.: 24" W x 40" D x 57" H
- Cart Material: Steel
- Lip Configuration: Lip Down/Lip Up
- Wheel Material: Blue Rubber
- Capacity: 1200 lbs.



MP085

Model No.	Panel	Price /Each
MN396	Louvered Panel for Small Parts Bins	829.00
MP084	Pegboard Panel for Hanging Tools	879.00
MP085	Half Pegboard and Half Louvered Panel	895.00

## ORDER PICKING CARTS

- All-welded design, ready to use
- Picking list holder eliminates the need to handle loose papers
- 14-gauge steel shelves with 1 1/2" lip, configured up
- Two rigid and two swivel bolted-on 5" non-marking rubber casters
- Capacity: 1200 lbs. evenly distributed
- Durable Kleton blue enamel finish



MB442

Model No.	Shelf Size		Number of Shelves	Clearance Between Shelves"	Handle Height"	Overall Dimensions			Wt. lbs.	Price /Each
	W"	x D"				W"	x D"	x H"		
MB440	18	x 30	2	27	36	18	x 46	x 36	70	525.00
MB441	24	x 36	2	27	36	24	x 52	x 36	80	579.00
ML095	24	x 48	2	27	36	24	x 64	x 36	110	639.00
MB442	18	x 30	3	12	36	18	x 46	x 36	85	585.00
MB443	24	x 36	3	12	36	24	x 52	x 36	100	639.00
ML096	24	x 48	3	12	36	24	x 64	x 36	120	739.00

## HEAVY-DUTY SHELF CARTS WITH DRAWER

- All-welded design, ready to use
- Cart constructed from 14-gauge steel shelves welded to 1 1/2" x 1 1/2" x 1/8" steel angle posts
- 1" diameter tubular steel handle
- Lockable drawer for supplies
- Drawer dimensions: 15 1/4" W x 20" L x 6" H, 100-lb. capacity
- Available in models with 2 or 3 shelves with 1 1/2" lip configured up
- Two rigid and two swivel bolted-on 5" non-marking casters
- Capacity: 1200 lbs. evenly distributed
- Durable Kleton blue enamel finish



MH255

Model No.	Shelf Size		Number of Shelves	Clearance Between Shelves"	Drawer to Shelf Clearance"	Handle Height"	Overall Dimensions			Wt. lbs.	Price /Each
	W"	x D"					W"	x D"	x H"		
MH255	24	x 36	2	27	18	36	24	x 39	x 36	75	599.00
MH256	24	x 36	3	12	3	36	24	x 39	x 36	95	659.00
ML081	24	x 48	2	27	18	36	24	x 51	x 36	110	675.00
ML082	24	x 48	3	12	3	36	24	x 51	x 36	120	735.00

## STOCK PICKING CARTS

- All-welded design, ready to use
- Pick and transport stock without the need for a separate ladder
- Slip-resistant steps and positive locking engagement for safety
- 14-gauge steel shelves with 1 1/2" lip, configured up
- Two rigid and two swivel bolted-on 5" non-marking rubber casters
- Capacity: 1200 lbs. evenly distributed
- Durable Kleton blue enamel finish



MB507

Model No.	Shelf Size		Number of Steps	Number of Shelves	Clearance Between Shelves"	Step Size		Overall Dimensions			Wt. lbs.	Price /Each	
	W"	x D"				W"	x D"	W"	x D"	x H"			
MD441	24	x 36	3	3	12	22	x 4	9 1/2"	24	x 52	x 61	135	828.00
MB507	24	x 48	3	3	12	22	x 4	9 1/2"	24	x 64	x 61	140	909.00
MD442	24	x 36	5	3	12	22	x 4	9 1/2"	24	x 52	x 78	145	939.00
MB508	24	x 48	5	3	12	22	x 4	9 1/2"	24	x 64	x 78	150	1018.00

# CARTS

## UTILITY SERVICE CART

- Durable structural foam construction will not dent, rust, or bend
- Non-marking 5" casters
- Based on evenly distributed weight capacity
- No. of Shelves: 2
- Capacity: 550 lbs.
- Cart Material: Polypropylene
- Wheel Material: Rubber
- Lip Configuration: Lip Up
- Clearance Between Shelves: 19-1/2"
- Handle Height: 32-1/2"



MP640

**KLETON**

Model No.	Overall			Shelf Dimensions			Price /Each
	W"	x	H"	W"	x	D"	
MP640	16-1/2	x	32-1/2	x	34-1/2	17-1/2 x 34-1/2	187.00
MP641	24-5/8	x	32-1/2	x	40	24-3/8 x 36-1/4	195.00

## PLASTIC FLAT SHELF UTILITY SERVICE CARTS

- Durable structural foam construction will not dent, rust or bend
- Non-marking 5" casters
- Flat top shelf makes loading and unloading of heavy boxes easy
- Capacity: 500 lbs. evenly distributed



**KLETON**

Model No.	Overall Dimensions					Price /Each
	W"	x	D"	x	H"	
MP642	25 1/2	x	40 1/2	x	32 1/2	247.00

## FLAT SHELF UTILITY CARTS

- Ergonomic handle design improves control and worker safety
- Flat design makes loading and unloading of heavy boxes and parts easier
- Easy to reach tool/accessory hooks and storage area enhances productivity and organization
- Constructed from sturdy structural foam that will not rust, dent, chip nor splinter
- 2 swivel and 2 fixed 5" non-marking TPR casters
- Capacity is based on evenly distributed weight



ML456

**Rubbermaid**  
Commercial Products

## HEAVY-DUTY UTILITY CARTS

- Ergonomic handle design improves control and worker safety
- Easy to reach tool / accessory hooks and storage area enhances productivity and organization
- 2 3/4" deep top shelf securely holds contents
- Constructed from sturdy structural foam that will not rust, dent, chip nor splinter
- 2 swivel and 2 fixed casters
- Capacity is based on evenly distributed weight



ML448

Model No.	Colour	Capacity lbs.	Dimensions				Wt. lbs.	Price /Each	
			W"	x	D"	x			H"
ML456	Black	500	17 1/4	x	38 1/2	x	38 1/4	33	449.00
ML458	Black	500	25 7/8	x	43 9/10	x	33 3/10	42	505.00

Model No.	Block	Beige	Caster Type	Capacity /lbs.	Dimensions				Wt. lbs.	Price /Each
					W"	x	D"	x		
ML448	ML449	5" Non-Marking TPR	500	17 1/8	x	39	x	33 1/4	31	355.00
ML450	ML451	5" Non-Marking TPR	500	25 1/4	x	44	x	39	44	473.12
ML453	-	5" Non-Marking TPR	750	26	x	55	x	33 1/4	52	969.00

## EXECUTIVE SERVICE CARTS

- Sleek, contemporary styling ideal for office use
- Rounded handles improve cart manoeuvrability
- Dimensions: 20" W x 39" D x 38" H
- Capacity per shelf: 100 lbs. evenly distributed
- Solid rounded bumper is gentle on walls and furniture



**Rubbermaid**  
Commercial Products



Model No.	Colour	Wt. lbs.	Price /Each
ML365	Black	35	609.00

## UTILITY CARTS

- Shelf design allows for quick and easy loading
- Light and easy to maneuver
- Cart Material: Plastic
- Construction: Knocked Down
- Wheel Material: Rubber
- Capacity: 250 lbs
- No. of shelves: 3
- Assembly required



**KLETON**



JH486

Model No.	Overall Dimensions					Price /Each
	W"	x	H"	x	D"	
JH487	16-3/4	x	37	x	33-1/2	209.00
JH486	19-3/4	x	37-1/2	x	40-1/4	285.00

## LIGHT-DUTY UTILITY CARTS

- Durable plastic construction
- Comes with middle shelf and two convenient handles
- Shelves are flat with retaining beaded edges
- 4" swivel non-marking casters
- Capacity is based on evenly distributed weight



**Rubbermaid**  
Commercial Products

Model No.	Capacity lbs.	Shelf Size				Colour	Wt. lbs.	Price /Each	
		W"	x	D"	x				H"
MH223	200	19	x	34	x	38	Platinum	30	427.42
ML364	200	19	x	34	x	38	Black	30	427.42



MH223



ML364

## TRADEMASTER™ MOBILE CABINETS & WORK CENTRES

- Raised ergonomic handle reduces wrist and back strain
- Open front top for easy access to work surface
- 3-outlet, surge protected power strip, 15' cord and wrap (UL/CSA listed)
- Two swivel with brake and two fixed 5" casters
- 4" deep drawers support 40 lbs. and feature locking system
- Metal reinforced structural foam shelves
- Capacity is based on evenly distributed weight
- Shipped knocked-down



MH685



MH681

Model No.	Description	Dimensions			Capacity lbs.	Wt. lbs.	Price /Each
		W"	x D"	x H"			
MH681	4 Drawers	18 5/8	x 40 5/8	x 38 3/8	500	87	2010.06
MH685	4 Drawers and Cabinet	26 1/4	x 49	x 38	750	123	2142.30

## TRADES CARTS

- Use as mobile workbench
- Sized to hold large tools and supplies yet fits in tight spaces
- Four compartmentalized parts boxes and two versatile storage bins
- Mounting bracket serves as an electrical cord wrap and convenient handle bin to keep small tools/parts
- Constructed of black plastic for lightness and durability
- 5" casters (2 with brakes)
- Also available with a fully enclosed, lockable storage compartment
- Dimensions: 38" L x 19 1/4" W x 33 3/8" H
- Capacity: 180 lbs. (top shelf), 150 lbs. (bottom shelf) evenly distributed

Model No. MK744

Weight: 50 lbs.

Price/Each \$1014.26

Model No. MK745

Weight: 68 lbs.

Trades Cart w/Lockable Cabinet

Price/Each \$1382.62



MK744



MK745

## HEAVY-DUTY ERGO UTILITY CARTS

- Easily access items with 13.5" clearance between shelves
- Patented ergonomic handle improves control and worker safety
- Durable construction stands up to the toughest tasks
- Easy to move with 2 fixed casters and 2 locking, swivel casters
- Saves valuable time by reducing trips
- Built-in tool holster and caddy keeps items at hand and in place during transport
- No. of Shelves: 4
- Capacity: 700 lbs.
- Cart Material: Structural Foam
- Overall Dim.: 24.25" W x 54.1" D x 62.4" H
- Construction: Knocked Down
- Colour: Black

Model No. MP497

Mfg. No. 2128657

Price/Each \$1989.00



## MYCART™ UTILITY CARTS

- Corrosion proof, smooth polymer surfaces easily wipe clean
- Shelf cutaway for better leg clearance
- Built-in tray to manage the smaller items
- Four chrome-plated posts
- Ergonomic easy grip handle
- Each cart includes two labels for easy identification
- Thermoplastic non-marking casters
- Shipped knocked down



MN472



Grey Model No.	Black Model No.	No. Shelves	Shelf Dim.		Overall Dim.			Cap. lbs.	Wt. lbs.	Price /Each
			W"	L"	W"	x D"	x H"			
MN472	MN478	2	16	x 27	18 5/16	x 31 1/2	x 35 1/2	300	28.5	457.00
MN473	MN479	3	16	x 27	18 5/16	x 31 1/2	x 35 1/2	400	34	534.00
MN474	MN480	2	20	x 30	23 7/16	x 34 3/8	x 35 1/2	300	33	488.00
MN475	MN481	3	20	x 30	23 7/16	x 34 3/8	x 35 1/2	400	41.5	597.00
MN476	MN482	2	26	x 36	27 11/16	x 40 1/4	x 36 7/8	400	40	583.00
MN477	MN483	3	26	x 36	27 11/16	x 40 1/4	x 36 7/8	500	51	689.00



# WIRE MESH TRUCKS

## WIRE MESH SHELF TRUCKS

- Rugged all-welded steel construction ready to use
- Designed for efficient loading/unloading and transportation of merchandise
- 14-gauge steel shelves, 1 1/2" lip up
- Frame constructed from 1 1/2" angle iron and 2" x 2" wire mesh
- Includes: Two rigid and two swivel 5" or 6" bolted-on casters
- Capacity: 1200-2400 lbs. evenly distributed
- Durable Kleton blue enamel finish

5" Non-Marking Rubber 1200-lbs. Cap. Model No.		6" Polyurethane 2400-lbs. Cap. Model No.		Base W" x L"	Inside Wall Height"	Handle Height"	Clearance Between Shelves"	Overall Dimensions W" x L" x H"	Wt. lbs.
<b>TWO-SIDED, 2 SHELVES</b>									
ML163	849.00	ML169	1185.00	24 x 48	55	42	26	24 x 51 x 63	112
ML164	1095.00	ML170	1439.00	24 x 60	55	42	26	24 x 63 x 63	127
ML165	1129.00	ML171	1385.00	30 x 48	55	42	26	30 x 51 x 63	129
ML166	1225.00	ML172	1545.00	30 x 60	55	42	26	30 x 63 x 63	144
ML167	1319.00	ML173	1645.00	30 x 72	55	42	26	30 x 75 x 63	167
<b>TWO-SIDED, 3 SHELVES</b>									
ML175	969.00	ML181	1305.00	24 x 48	55	42	16 1/2	24 x 51 x 63	137
ML176	1279.00	ML182	1645.00	24 x 60	55	42	16 1/2	24 x 63 x 63	152
ML177	1319.00	ML183	1689.00	30 x 48	55	42	16 1/2	30 x 51 x 63	154
ML178	1415.00	ML184	1805.00	30 x 60	55	42	16 1/2	30 x 63 x 63	169
ML179	1515.00	ML185	1859.00	30 x 72	55	42	16 1/2	30 x 75 x 63	192
<b>THREE-SIDED, 1 SHELF</b>									
ML221	839.00	ML191	1165.00	24 x 48	55	42	-	24 x 51 x 63	110
ML222	989.00	ML192	1259.00	24 x 60	55	42	-	24 x 63 x 63	120
ML223	959.00	ML193	1305.00	30 x 48	55	42	-	30 x 51 x 63	135
ML224	1069.00	ML194	1395.00	30 x 60	55	42	-	30 x 63 x 63	145
ML225	1199.00	ML195	1475.00	30 x 72	55	42	-	30 x 75 x 63	155
<b>THREE-SIDED, 2 SHELVES</b>									
ML197	959.00	ML203	1335.00	24 x 48	55	42	26	24 x 51 x 63	142
ML198	1185.00	ML204	1439.00	24 x 60	55	42	26	24 x 63 x 63	159
ML199	1115.00	ML205	1545.00	30 x 48	55	42	26	30 x 51 x 63	182
ML200	1255.00	ML206	1569.00	30 x 60	55	42	26	30 x 63 x 63	192
ML201	1415.00	ML207	1739.00	30 x 72	55	42	26	30 x 75 x 63	211
<b>THREE-SIDED, 3 SHELVES</b>									
ML209	1065.00	ML215	1455.00	24 x 48	55	42	16 1/2	24 x 51 x 63	174
ML210	1379.00	ML216	1709.00	24 x 60	55	42	16 1/2	24 x 63 x 63	198
ML211	1319.00	ML217	1739.00	30 x 48	55	42	16 1/2	30 x 51 x 63	229
ML212	1469.00	ML218	1839.00	30 x 60	55	42	16 1/2	30 x 63 x 63	239
ML213	1515.00	ML219	1935.00	30 x 72	55	42	16 1/2	30 x 75 x 63	267

## SECURITY TRUCKS

- Rugged all-welded steel construction, ready to use
- Designed for efficient loading/unloading and transportation of merchandise
- 14 gauge steel shelves, 1 1/2" lip up
- Frame constructed from 1 1/2" angle iron and 2" x 2" wire mesh
- Includes: Two rigid and two swivel 5" or 6" bolted-on casters
- Comes with hasp for padlock
- Capacity: 1200-2400 lbs. evenly distributed
- Durable Kleton blue enamel finish

5" Non-Marking Rubber 1200-lbs. Cap. Model No.		6" Polyurethane 2400-lbs. Cap. Model No.		Base W" x L"	Inside Wall Height"	Handle Height"	Clearance Between Shelves"	Overall Dimensions W" x L" x H"	Wt. lbs.
<b>2 SHELVES</b>									
ML238	1389.00	ML244	1869.00	24 x 36	55	42	25	26 x 39 x 62 1/2	157
ML239	1485.00	ML245	1879.00	24 x 48	55	42	25	26 x 51 x 62 1/2	172
ML240	1729.00	ML246	2049.00	24 x 60	55	42	25	26 x 63 x 62 1/2	189
ML241	1679.00	ML247	2089.00	30 x 48	55	42	25	32 x 51 x 62 1/2	212
ML242	1869.00	ML248	2185.00	30 x 60	55	42	25	32 x 63 x 62 1/2	222
ML243	1955.00	ML249	2279.00	30 x 72	55	42	25	32 x 75 x 62 1/2	241
<b>3 SHELVES</b>									
ML250	1429.00	ML256	1875.00	24 x 36	55	42	16	26 x 39 x 62 1/2	182
ML251	1589.00	ML257	1939.00	24 x 48	55	42	16	26 x 51 x 62 1/2	204
ML252	1829.00	ML258	2279.00	24 x 60	55	42	16	26 x 63 x 62 1/2	228
ML253	1869.00	ML259	2205.00	30 x 48	55	42	16	32 x 51 x 62 1/2	259
ML254	1949.00	ML260	2409.00	30 x 60	55	42	16	32 x 63 x 62 1/2	269
ML255	2039.00	ML261	2395.00	30 x 72	55	42	16	32 x 75 x 62 1/2	297

## WIRE MESH BOX TRUCKS

- Rugged all-welded 1 1/2" angle iron construction and 2" x 2" wire mesh, ready to use
- Contain and transport small bulk parts or materials in your plant or warehouse
- Includes: 2 rigid and 2 swivel 5" non-marking bolted-on rubber casters
- Capacity: 1200 lbs. evenly distributed
- Durable Kleton blue enamel finish

Model No.	Base		Inside Wall Height"	Handle Height"	Overall Size			Wt. lbs.	Price /Each
	W"	x L"			W"	x L"	x H"		
MB672	24	x 36	24	30	24	x 39	x 31 1/2	62	735.00
ML186	24	x 48	24	30	24	x 51	x 31 1/2	75	849.00
ML187	24	x 60	24	30	24	x 63	x 31 1/2	85	939.00
ML188	30	x 48	24	30	30	x 51	x 31 1/2	86	959.00
MB680	30	x 60	24	30	30	x 63	x 31 1/2	95	975.00
ML189	30	x 72	24	30	30	x 75	x 31 1/2	107	1225.00



KLETON



ML163



ML200



ML254



KLETON



MB672



KLETON

## WIRE MESH STOCK TRUCKS

- Rugged all-welded steel construction, ready to use
- Designed for efficient loading/unloading and transportation of merchandise
- Frame constructed from 1 1/2" angle iron and 2" x 2" wire mesh
- Includes: Two rigid and two swivel bolted-on casters
- Durable Kleton blue enamel finish
- Capacity is based on evenly distributed weight
- Height Without Casters: 55"



MO060



Model No.	Capacity lbs.	Overall Width"	Overall Depth"	Unit Height With Casters"	Drop Gate	Price /Each
<b>5" RUBBER CASTERS</b>						
MO044	1200	26	39	63	No	925.00
MO045	1200	26	39	63	Yes	1129.00
MO048	1200	26	51	63	No	939.00
MO049	1200	26	51	63	Yes	1139.00
MO052	1200	26	63	63	No	1109.00
MO053	1200	26	63	63	Yes	1309.00
MO056	1200	32	51	63	No	1065.00
MO057	1200	32	51	63	Yes	1265.00
MO060	1200	32	63	63	No	1189.00
MO061	1200	32	63	63	Yes	1389.00
MO064	1200	32	75	63	No	1335.00
MO065	1200	32	75	63	Yes	1535.00
<b>6" POLYURETHANE CASTERS</b>						
MO046	2400	26	39	64	No	1109.00
MO047	2400	26	39	64	Yes	1309.00
MO050	2400	26	51	64	No	1135.00
MO051	2400	26	51	64	Yes	1335.00
MO054	2400	26	63	64	No	1299.00
MO055	2400	26	63	64	Yes	1499.00
MO058	2400	32	51	64	No	1275.00
MO059	2400	32	51	64	Yes	1469.00
MO062	2400	32	63	64	No	1389.00
MO063	2400	32	63	64	Yes	1595.00
MO066	2400	32	75	64	No	1539.00
MO067	2400	32	75	64	Yes	1739.00

## MOBILE WIRE SPOOL CARTS

- 6 removable spool rods (3 per side)
- 2x 18" wide louvered panels on each end
- 5" non-marking blue rubber casters; 2 swivel with brake and 2 rigid
- Extended push handle on the end with the swivel casters
- Durable Kleton blue enamel finish
- Capacity: 1200 lbs.
- Cart Material: Steel
- Overall Dim.: 21" W x 38" D x 48" H
- Construction: All-Welded



Model No.	Description	Price /Each
MP086	Spool Cart	749.00
ML338	Rigid Caster	24.05
ML345	Swivel Caster w/Brake	32.60

## ENCLOSED WIRE SHELF CARTS

- High quality chromate shelves and posts prevent corrosion
- Enclosed sides keeps items from falling out
- Shelves can be adjusted quickly and easily
- Strong and versatile
- Includes: (2) 5" swivel resilient casters, (2) 5" rubber caster with brakes
- Shipped knocked down
- One-year limited warranty
- Capacity is based on evenly distributed weight
- NSF certified
- No. of Shelves: 4
- Capacity: 800 lbs.

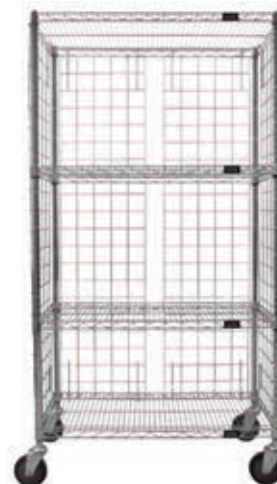

Model No.	Overall Dim.					Price /Each
	W"	x	D"	x	H"	
RN559	18	x	36	x	69	529.00
RN560	18	x	48	x	69	659.00
RN561	18	x	60	x	69	749.00
RN562	24	x	36	x	69	689.00
RN563	24	x	48	x	69	759.00
RN564	24	x	60	x	69	785.00

## CABLE REEL ROLLERS

- The ideal method for winding or dispensing cable, chain, wire, rope and hose
- Turns reel handling into a one person job
- Accommodates unlimited reel widths and all reel diameters with flanges up to 5 1/2" thick; rear roller adjusts to 6 positions
- Heavy-duty side rollers eliminate slipping or wedging between rollers and reel
- Inclined ramp permits easy loading and unloading
- Each unit measures 28" L x 9 1/4" W x 4" H
- Capacity: 3000 lbs. in pairs
- Weight: 58 lbs./pr.

Model No. MD166  
Price/Each \$855.00/Pair



# HOPPERS

## STEEL SELF-DUMPING HOPPERS

- Fork lift-operated self-dumping hoppers
- Designed specifically for efficient handling of scrap metal, raw materials and other bulk materials
- Available in capacities ranging from 1/2 to 5 cubic yards
- Can be fitted with casters for better mobility
- Standard 10-gauge thickness, heavy-duty 3/16" thickness or extra heavy-duty 1/4" steel construction
- Colour: Blue
- Casters not included
- F.O.B. Laval, QC or Winnipeg, MB



MN951



Hoppers roll forward when unlatched for easy dumping



Hoppers can be used with casters, a forklift truck or both

### APPLICATION GUIDELINE

- Standard 10-gauge (9/64"):** General use, factory waste and small metal parts.
- Heavy-Duty 7-gauge (3/16"):** Rugged use, heavy duty metals in construction field.
- Extra Heavy-Duty 3-gauge (1/4"):** For extreme conditions, heavy material dropped in container. Handling of hot materials, in refineries.

Capacity Cu. Yards	Standard 10-ga. (9/64")			Heavy-Duty 7-ga. (3/16")			Extra Heavy-Duty 3-ga. (1/4")		
	F.O.B. Laval, QC Model No.	F.O.B. Winnipeg, MB Model No.	Price /Each	F.O.B. Laval, QC Model No.	F.O.B. Winnipeg, MB Model No.	Price /Each	F.O.B. Laval, QC Model No.	F.O.B. Winnipeg, MB Model No.	Price /Each
1/2	NB949	MN951	2919.00	NB950	MN952	3169.00	NB948	-	3419.00
3/4	NB955	MN954	3339.00	NB956	MN955	3745.00	NB954	-	3975.00
1	NB967	MN957	3669.00	NB968	MN958	4025.00	NB966	MN959	4425.00
1-1/2	NB961	MN960	3905.00	NB962	MN961	4349.00	NB960	MN962	4799.00
2	NB973	MN963	4249.00	NB974	MN964	4759.00	NB972	MN965	5329.00
3	NB979	MN966	5659.00	NB980	MN967	6275.00	NB978	MN968	6975.00
4	NB985	MN969	6595.00	NB986	MN970	7339.00	NB984	MN971	8185.00
5	NH094	MN972	7585.00	NH095	MN973	8445.00	NH096	MN974	9425.00

### CASTER SETS FOR HOPPERS (F.O.B. LAVAL, QC)

- Set includes 2 rigid and 2 swivel casters

Model No.	Wheel Type	Price/Each
NB987	6" Phenolic	409.00
NB988	6" Rubber	465.00
NB989	6" Steel	635.00

### CASTER SETS FOR HOPPERS (F.O.B. WINNIPEG, MB)

- Set includes 2 rigid and 2 swivel casters

Model No.	Wheel Type	Price/Each
MO033	4" Polyurethane	405.00
MO034	5" Polyurethane	445.00
MO035	6" Polyurethane	515.00

## POLYETHYLENE SELF-DUMPING HOPPERS

- Safety chain to secure to fork lift
- Positive action release lever/latch prevents unwanted dumping
- Colour: Grey
- Fork Pocket Size: 3" H x 7.5" W



MP155



KLETON

Model No.	Dimensions			Capacity cu. yd.	Price /Each
	L"	x W"	x H"		
MP155	62	x 31	x 42	5/8	2425.00
MP156	72	x 37	x 47	1-1/10	2669.00
MD338	Caster Set				193.00



**EXCEEDING EXPECTATIONS**



## POLYETHYLENE TILT TRUCKS

- Ideal for transporting and dumping waste, scrap and other bulk materials
- Polyethylene body is mounted on an all-welded steel chassis
- Includes small swivel caster(s) at the front and large fixed wheels at the rear



MN980



MN982



MN981



MN983



Model No.	Durability	Overall Dimensions				Capacity		Front Wheel Type	Rear Wheel Type	Price /Each
		L" x W" x H"	L"	W"	H"	Cu. yd.	lbs.			
MN980	Light Duty	57 x 28 x 38	57	28	38	5/8	500	8" Mold-On Rubber	4" Non-Marking Rubber	585.00
MN981	Standard Duty	57 x 28 x 38	57	28	38	5/8	850	10" Mold-On Rubber	5" Non-Marking Rubber	845.00
MN982	Standard Duty	66 x 34 x 43	66	34	43	1.1	1250	12" Mold-On Rubber	5" Non-Marking Rubber	1149.00
MN983	Heavy Duty	66 x 34 x 43	66	34	43	1.1	2000	12" Mold-On Rubber	5" Non-Marking Rubber	1409.00

## STRUCTURAL FOAM TILT TRUCKS

- Size and shape is designed to fit through commercial doorways and elevators
- Ergonomically designed steering handle provides excellent manoeuvring and dumping capabilities
- Secondary handle, at the base, helps maintain control of the truck while finishing dumping action
- Models **ML534** and **ML535** feature TPR non-marking casters and 10" wheels
- Models **MK757**, **MK758**, **ML536** and **ML537** feature TPR non-marking casters and 12" wheels
- Colour: Black



MK757



Model No.	Capacity		Dimensions				Wt. lbs.	Price /Each
	Cu. yds.	lbs.	L"	x W"	x H"			
ML534	1/2	450	57 1/2	x 26 3/4	x 33 3/4	87	1089.00	
ML535	1/2	850	57 1/2	x 26 3/4	x 33 3/4	96	1295.00	
MK757	3/4	600	64 1/2	x 30 1/4	x 38	92	1365.00	
MK758	3/4	1000	64 1/2	x 30 1/4	x 38	99	1595.00	
ML536	1	1250	70 3/4	x 33 1/2	x 42 1/4	139	1859.00	
ML537	1	2100	70 3/4	x 33 1/2	x 42 1/4	141	2219.00	

### DOMED LIDS

ML538	Domed lid for ML534 and ML535	325.00
MK780	Domed lid for MK757 and MK758	415.00

## POLYETHYLENE TILT TRUCKS

- Sturdy, rotationally-molded plastic construction ensures easy manoeuvrability and dumping
- Smooth surface is easy to clean and resists pitting and corroding
- Inset wheel and axle design helps prevent damage to surfaces and equipment
- Colour: Black
- Accepted for use in Canadian food processing facilities



MK769



Model No.	Capacity		Dimensions				Wt. lbs.	Price /Each
	Cu. yds.	lbs.	L"	x W"	x H"			
MK788	1/2	450	56 3/4	x 28	x 38 1/2	63	1055.00	
MK769	1/2	850	60 1/2	x 28	x 38 1/2	77	1663.90	
MK789	1	850	72 1/4	x 33 1/2	x 43 3/4	111	1449.00	
MK770	1	1250	72 1/4	x 33 1/2	x 43 3/4	111	2087.54	

### RECYCLING TILT TRUCKS

ML540	1/2	850	60 1/2	x 28	x 38 1/2	77	1740.16
<b>LIDS</b>							
ML541	Lid for MK788 and MK769					365.00	
ML542	Lid for MK789 and MK770					465.00	

# BOX TRUCKS

## EASY ACCESS POLY BOX TRUCKS

- Drop-style side wall allows for easy loading and unloading
- Bin Material: Polyethylene
- Caster Placement: Corner Standard
- Bin Colour: Grey
- Base Type: Plywood
- Caster Type: Non-marking blue rubber



MP035

**KLETON**

Model No.	Capacity		O.A. Dimensions			Caster Dia."	Price /Each
	Cu. ft.	lbs.	L" x W" x H"				
MP035	22	1000	45-3/4 x 31-1/4 x 37-3/4	4	695.00		
MP036	24	1200	63 x 34-1/4 x 38-1/2	5	849.00		

## MINI STARCARTS™

- Designed to take the punishment of industrial and institutional applications at an economical price
- Polyethylene construction
- Plated steel undercarriage
- 3" all swivel Threadguard casters, corner placement
- Colour: Grey



NC461

**TECHSTAR PLASTICS INC.**

Model No.	Capacity		O.A. Dimensions			Wt. lbs.	Price /Each
	Cu. ft.	lbs.	L" x W" x H"				
NC461	6	200	33 x 19 x 28	25	254.00		
NA001	8	300	35 x 25 x 25	30	295.00		
NC464	9	300	48 x 19 x 28	40	335.00		

## HEAVY-DUTY OVERSIZED STARCARTS™

- Tapered walls for easy shipping and storage
- Treated plywood undercarriage
- Corner or diamond caster placement
- Colour: Grey (other colours available)



ML543

**TECHSTAR PLASTICS INC.**

Model No.	Capacity		Dimensions			Caster Dia."	Caster Placement	Wt lbs.	Price /Each
	Cu. ft.	lbs.	L" x W" x H"						
ML543	22	800	59 x 35 x 32	5	Corner	70	672.00		
ML544	22	800	59 x 35 x 32	5	Diamond	70	692.00		
ML545	24	800	53 x 35 x 38	5	Corner	85	713.00		
ML546	24	800	53 x 35 x 38	5	Diamond	85	734.00		

## STARCARTS™

- Polyethylene construction
- Easy maneuverability is ensured with 4" threadguard (2 rigid and 2 swivel)
- Corner or diamond caster placement
- Treated plywood undercarriage
- Body Colour: Grey
- Other colours available



NA004



MN466

**TECHSTAR PLASTICS INC.**

Model No.	Capacity		O.A. Dimensions			Caster Dia."	Caster Placement	Wt. lbs.	Price /Each
	Cu. ft.	lbs.	L" x W" x H"						
NA002	12	400	39 x 27 x 30	3	Diamond	40	331.00		
NA004	12	800	39 x 27 x 31	4	Corner	50	444.00		
NA003	12	800	39 x 27 x 31	4	Diamond	50	457.00		
NC465	15	400	41 x 29 x 31	3	Diamond	45	404.00		
NC466	15	800	41 x 29 x 32	4	Corner	55	481.00		
NC467	15	800	41 x 29 x 32	4	Diamond	55	503.00		
NA006	16	400	43 x 31 x 33	3	Diamond	50	448.00		
NA007	16	800	43 x 31 x 34	4	Corner	60	540.00		
NA008	16	800	43 x 31 x 34	4	Diamond	60	555.00		
NC468	19	800	43 x 31 x 36	4	Corner	65	617.00		
NC469	19	800	43 x 31 x 36	4	Diamond	65	635.00		

### OPTIONAL SPRING PLATFORM

- Optional spring platform eliminates excess bending, therefore reducing the risk of back related injuries

Model No.	Description	Price/Each
MN466	Can be used with NA002, NA003 & NA004	194.00
MN467	Can be used with NC465, NC466, NC467, NA006, NA007, NA008, NC468 & NC469	190.00

## HEAVY-DUTY STARCARTS™

- Designed to offer increased load capacity while maintaining easy mobility
- Molded 100% polyethylene body has a double wall box style lip for greater resistance to impact
- Steel undercarriage
- Molded handle
- 10" and 12" semi-pneumatic wheels are made of durable hard rubber
- 5" swivel rubber or 6" swivel phenolic casters depending on capacity
- Colour: Blue



NG033

**TECHSTAR PLASTICS INC.**

Model No.	Capacity		O.A. Dimensions			Wheel Dia."	Caster Dia."	Wt. lbs.	Price /Each
	Cu. ft.	lbs.	L" x W" x H"						
NG033	16	1000	48 x 31 x 34 1/2	10	5	80	780.00		
NA052	24	1000	60 x 31 1/2 x 35 1/2	12	5	100	933.00		
NA053	39	1500	72 x 35 1/2 x 40	12	6	130	1454.00		

## JUMBO STARCARTS™

- 6" Threadguard casters in diamond pattern (corner pattern available on request)
- Recessed plywood undercarriage
- Easy access cut-out
- Colour: Grey



**TECHSTAR PLASTICS INC.**

Model No.	Capacity		Inside Dim.			Outside Dim.			Max. Load lbs.	Wt. lbs.	Price /Each
	Cu. ft.	lbs.	L" x W" x H"	L" x W" x H"	L" x W" x H"						
NG957	60	62 x 42 x 42	65 x 45 x 54	1500	200	1584.00					

Note: Available with various cut-out options

## HEAVY DUTY WHITE WALL POLY BOX TRUCK

- Seamless durable 100% polyethylene bins
- Leakproof and easy to clean
- Available with 3/4" treated plywood undercarriage or all-welded steel chassis with a durable Kleton blue enamel finish
- Includes 2 swivel and 2 rigid casters
- Capacity is based on evenly distributed weight
- Bin Colour: White
- Bin Material: White polyethylene
- Caster Placement: Corner standard



Model No.	Base	Capacity Cu. ft.	Capacity lbs.	Overall Dimensions L" x W" x H"	Caster Type	Price /Each
<b>TAPERED WALL</b>						
MN990*	Plywood	7	600	33 x 20 x 29	4" Non-Marking Blue Rubber	475.00
MN991*	Steel Chassis	7	1000	33 x 20 x 29	4" Non-Marking Blue Rubber	839.00
MN992*	Plywood	9	600	37 x 26 x 31	4" Non-Marking Blue Rubber	479.00
MN993*	Steel Chassis	9	1000	37 x 26 x 31	4" Non-Marking Blue Rubber	859.00
MN994*	Plywood	12	600	39 x 27 x 31	4" Non-Marking Blue Rubber	579.00
MN995*	Steel Chassis	12	1000	39 x 27 x 31	4" Non-Marking Blue Rubber	955.00
MN998*	Plywood	16	600	43 x 30 x 34	4" Non-Marking Blue Rubber	725.00
MN999*	Steel Chassis	16	1000	43 x 30 x 34	4" Non-Marking Blue Rubber	1139.00
<b>STRAIGHT WALL</b>						
MN996	Plywood	14	600	46 x 28 x 31	4" Non-Marking Blue Rubber	679.00
MN997	Steel Chassis	14	1000	46 x 28 x 31	4" Non-Marking Blue Rubber	1009.00
M0001	Plywood	22	600	57 x 34 x 33	5" Non-Marking Blue Rubber	735.00
M0002	Steel Chassis	22	1000	57 x 34 x 33	5" Sandwich	1249.00
M0003	Plywood	25	1000	51 x 33 x 39	5" Non-Marking Blue Rubber	789.00
M0004	Steel Chassis	25	1000	51 x 33 x 39	5" Sandwich	1365.00

\*Stackable for storage

## HEAVY DUTY ELEVATED STARCARTS™

- Built for heavy loads
- Large 4" all-swivel threadguard casters
- Power coated reinforced steel frame
- Removable plastic body
- Bin Material: Polyethylene
- Colour: Blue



Model No.	Capacity Cu. ft.	Capacity lbs.	Inside Dimensions L" x W" x H"	Overall Dimensions L" x W" x H"	Price /Each
M0008	9	1000	45 x 22 x 15	48 x 24 x 36	835.00

## HEAVY-DUTY POLYETHYLENE BOX TRUCKS

- Seamless durable 100% polyethylene bins
- Leakproof and easy to clean
- Available with 3/4" treated plywood undercarriage or all-welded steel chassis with a durable Kleton blue enamel finish
- Includes 2 swivel and 2 rigid casters
- Capacity is based on evenly distributed weight
- Stackable for storage
- Caster type: 3" Polyolefin
- Bin Colour: Black
- Bin Material: Polyethylene
- Caster Placement: Corner standard
- Tapered walls



Model No.	Base	Capacity Cu. ft.	Capacity lbs.	Overall Dimensions L" x W" x H"	Price /Each
MN984	Plywood	9	500	37 x 26 x 30	355.00
MN985	Steel Chassis	9	800	37 x 26 x 30	469.00
MN986	Plywood	12	500	39 x 27 x 30	419.00
MN987	Steel Chassis	12	800	39 x 27 x 30	545.00
MN988	Plywood	16	500	43 x 30 x 33	545.00
MN989	Steel Chassis	16	800	43 x 30 x 33	775.00

## LIGHT-DUTY POLYETHYLENE BOX TRUCKS

- Designed for lighter loads
- Rotomolded from black recycled plastic
- All-swivel threadguard casters
- Includes a plywood base



Model No.	Capacity Cu. ft.	Capacity lbs.	Overall Dimensions L" x W" x H"	Caster Size"	Weight lbs.	Price /Each
NA005	12	200	39 x 27 x 29	3	30	240.00

Stay safe & work confidently with **ZENITH®** Safety Products





# WIRE REEL CADDIES

## PORTABLE WIRE REEL CADDY

- Mobile storage for wire spools, reels, and cables
- Ideal for electricians, contractors and builders
- Ready to use, all-welded steel construction
- 4" wide tool tray included
- Rolls on 8" mold-on rubber wheels
- 4 clip-in-place rods for easy spool change
- Holds up to 8" diameter spools on top 3 rods
- Holds up to 12" diameter spools on lower rod
- Durable Kleton blue enamel finish
- Capacity: 400 lbs. (load capacity is based on evenly distributed weight)
- Dimensions: 24-1/2" W x 23" D x 49" H
- Weight: 52 lbs.

Model No. MO215  
Price/Each \$485.00



## WIRE REEL CADDIES

- Dispense wire in vertical or horizontal position
- Bottom of caddy includes wire guide holes for quick access
- Capacity: 300 lbs.
- Cart Material: Steel
- Construction: Welded
- Rod Quantity: 4
- Model MN706: Casters and handle are bolt-on design for easy removal
- Model MN707: Mount to a wall or transport with a hand truck



Model No.	Mfg. No.	Description	Overall Dimensions			Price /Each
			W"	x D"	x H"	
MN706	WIRE-D-WHK	Portable	29	x 21-7/8	x 47-7/8	535.00
MN707	WIRE-D	Stand Alone	22.25	x 16.25	x 44.25	359.00

## BINS & DRAWERS WIRE SPOOL RACK

- Prime cold-rolled steel construction
- Holes in bottom allow secure stacking
- 7 Rubberized grommets provided to keep wires free from tangling
- Modular to attach on top of bin and drawer cabinets that are also 33-3/4" wide
- The rear rod acts as a guide for the wire, so that it passes through the rubber grommets located at the front
- Ships fully assembled
- Durable, gray, powder coat finish
- Features recyclable, biodegradable, and/or recycled content, and reduced resource use or waste in the production of product
- Kit Type: Add-On
- Overall Capacity: 10" Diameter Spools
- Gauge: 18
- Colour: Grey
- Material: Steel



Model No.	Mfg. No.	Dimensions			No. of Rods	Price /Each
		W"	x D"	x H"		
TER223	387-95	33-3/4	x 9-5/16	x 10-5/8	2	149.00

## 8-ROD MOBILE WIRE SPOOL RACKS

- Heavy-duty, all-welded 14-gauge steel
- Allows for multiple types of spooled items to be efficiently organized and mobile
- 1 1/2" top shelf lip prevents parts from falling off during transport
- Eight 23" removable rods
- Four wire guides hang below the work surface for ease in cutting wire
- Louvered panels on both sides included (bins and trays sold separately)
- Four 5" polyurethane bolt-on casters; two rigid and two locking swivel
- Capacity: 1200 lbs. evenly distributed
- Durable grey powder coat finish



Model No.	Overall Dimensions*			Weight lbs.	Price /Each
	L"	x W"	x H"		
MN163*	32-1/4	x 18-1/8	x 46-1/16	112	1415.00

\* Overall length includes the 6" handle.

## MOBILE WIRE SPOOL & MAINTENANCE CARTS

- 1-1/2" lip on top work surface prevents parts from falling off during transport
- Heavy duty tubular handle makes transport easy
- Recessed rods allow protection of spools during transport
- Back low profile hanger holds one 6' ladder in an upright position
- Durable, textured powder coat finish
- Includes a locking cabinet to secure contents
- Louvered panel on end, accommodate Hook-On Bins® and metal Hook-On trays (Bins and trays sold separately)
- Has provision to handle boxes of light bulbs, conduit or PVC
- Four 5" x 1-1/4" polyurethane casters, 2 rigid and 2 locking swivel
- Ships fully assembled and ready for use
- Capacity: 1200 lbs.
- Cart Material: Steel
- Construction: All-Welded
- Rod Quantity: 5
- Colour: Grey



Model No.	Overall Dimensions			Weight lbs.	Price /Each
	L"	x W"	x H"		
M0996	54-1/16	x 24	x 35	205	2149.00

## PORTABLE WIRE REEL CADDIES

- Designed to easily move wire reels
- Dispense wire in vertical or horizontal position
- Total uniform capacity is 150 lbs. (90 lbs. on large spindles and 60 lbs. on small spindles)
- Portable with 6" diameter semi-pneumatic wheels
- Storage tray on top for added versatility
- Capacity: 150 lbs.
- Cart Material: Steel
- Overall Dim.: 19 1/2" W x 17 1/2" D x 43 1/4" H
- Rod Quantity: 11
- Model No. MN708
- Mfg. No. WIRE-D-E
- Price/Each \$325.00



# MACHINE & EQUIPMENT MOVERS

## TOE JACKS

- Strong, portable and safe
- Lifts loads with only 1" ground clearance
- 5 and 10-ton models operate horizontally and vertically
- Base, toe and pump assembly swivel independently of each other
- Perfect complement to any Hilman roller



Model No.	Max Lifting Height"	Pick-Up Position At Base"	Capacity At tops/tons	Wt. lbs.	Price /Each
MH825	8	1	14.50/5	44	3199.00
MH826	9	1	16.52/10	61	3925.00

## TRI-GLIDE THREE-POINT MOVER

- Ideal solution for moving heavy and bulky items safely
- 3-point system provides better mobility and stability even when turning
- Includes front unit and adjustable dolly (rear unit)
- Front unit features turntable with non-slip pad
- Dolly has non-slip pads on either side
- Handle Height: 43-1/2"
- Dolly Dimensions: 60"L x 12-9/16"W x 4"H
- Wheel Material: Nylon



Model No.	Capacity Tons	Front Unit Base Dim. L" x W" x H"	Front Unit Weight lbs.	Rear Dolly Weight lbs.	Price /Each
M0821	10	17-7/8 x 17-1/4 x 4	96	59	5325.00
M0822	15	22-4/16 x 17-1/4 x 4	106	62	6099.00
M0823	20	26-11/16 x 17-1/4 x 4	113	71	7755.00

## HILMAN ROLLER ECONOMY SETS

120 TO 200 TONS

Sets include:

Four swivel padded or diamond style rollers and 2 steering handles.

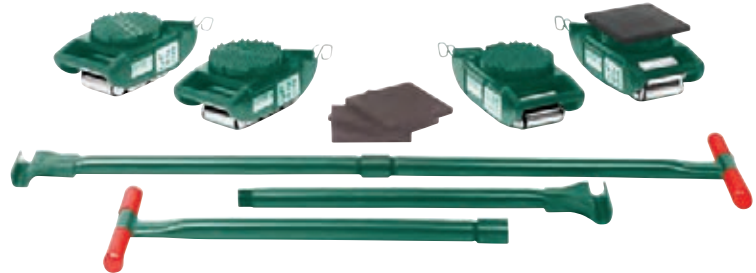

Model No.	Kit Cap. Tons	Rollers	Wt. lbs.	Price /Each
MH771	120	4 - Swivel Locking Padded	542	12015.00
MH772	120	4 - Swivel Locking Diamond	538	11729.00
MH773	200	4 - Swivel Locking Padded	834	16699.00
MH774	200	4 - Swivel Locking Diamond	846	16245.00

## MACHINE ROLLER KIT

- Made of high-strength annealed ductile iron
- These steel machine rollers have swivel tops that rotate 360° on chrome steel ball bearings to allow for easier turning
- The rollers form a "tank track" to revolve around a centre load bearing plate in the frame to provide maximum maneuverability
- The weight of the load is transferred directly from the load bearing plate to the rollers, eliminating axle friction and requiring less power to start and move
- These units are virtually maintenance free
- Steering bars split in two and connect with sleeve for easy storage

Kit Includes:

- (4) Machine Rollers
- (2) Steering Bars
- (1) Case



Model No.	Number of Rollers	Cap./Roller Tons	Roller Type	Overall Roller Height"	Roller Size W" x L"	Price /Each
MN679	4	1	Swivel	3.5	3.25 x 8	1629.00

## MACHINE ROLLERS

- Made of high-strength annealed ductile iron
- Swivel tops that rotate 360° on chrome steel ball bearings to allow for easier turning
- The rollers form a "tank track" to revolve around a centre load bearing plate in the frame to provide maximum maneuverability
- The weight of the load is transferred directly from the load bearing plate to the rollers, eliminating axle friction
- Optional steering bar split in two and connect with sleeve for easy storage



Model No.	Mfg. No.	Capacity Tons	Price /Each
LU262	VHMS-2	1	415.00
LU263	VHMS-8	4	605.00
LU264	VHMS-15	7.5	589.00
LU265	VHMS-30	15	769.00

## STEERING BARS

Model No.	Mfg. No.	Length"	For Use With	Wt. lbs.	Price /Each
LW531	VHMH-36-2	36	LU263, LU264 & LU265	15	99.50
LU267	VHMH-48-2	50 1/2	LU263, LU264 & LU265	17	115.00

# DOLLIES

## HARDWOOD DOLLIES

- Kiln dried
- Countersunk bolts prevent scratches
- Wood thickness: 7/8"
- Rounded edges and handles facilitate storage and mobility
- Non-marking casters
- Shipped knocked down



Model No.	Size W" x D"	Caster Type	Caster Size"	Capacity lbs.*	Price /Each
<b>ALL-WOOD</b>					
MN189	18 x 24	Polyolefin	3	900	75.50
MN195	18 x 24	Polyurethane	3	900	75.95
MN201	18 x 24	Polyolefin	4	1000	79.25
MN207	18 x 24	Polyurethane	4	1600	119.00
MN213	18 x 24	Blue Elastic	4	1400	109.00
MN192	18 x 30	Polyolefin	3	900	79.25
MN198	18 x 30	Polyurethane	3	900	79.95
MN204	18 x 30	Polyolefin	4	1000	83.20
MN210	18 x 30	Polyurethane	4	1600	125.00
MN216	18 x 30	Blue Elastic	4	1400	115.00
<b>CARPETED ENDS</b>					
MN190	18 x 24	Polyolefin	3	900	82.50
MN196	18 x 24	Polyurethane	3	900	86.55
MN202	18 x 24	Polyolefin	4	1000	86.95
MN208	18 x 24	Polyurethane	4	1600	130.00
MN214	18 x 24	Blue Elastic	4	1400	114.00
MN193	18 x 30	Polyolefin	3	900	86.60
MN199	18 x 30	Polyurethane	3	900	90.85
MN205	18 x 30	Polyolefin	4	1000	91.25
MN211	18 x 30	Polyurethane	4	1600	136.00
MN217	18 x 30	Blue Elastic	4	1400	119.00

\*Evenly distributed

## PREMIUM HARDWOOD DOLLIES

### MEDIUM-DUTY

- 7/8" wood top; countersunk bolts
- Carpeted dolly will prevent marks and scratches on equipment being moved
- 3" polyolefin casters
- Capacity: 900 lbs. evenly distributed
- Shipped knocked down
- Carpeted dolly comes with a frame with a hollow middle and a pad



Medium-duty

### HEAVY-DUTY

- 1 3/4" wood top (2 x 7/8" pieces); countersunk bolts
- 4" resilient non-marking casters
- Capacity: 1400 lbs. evenly distributed
- Shipped knocked down
- Carpeted dolly comes with a frame with a hollow middle and a pad



Heavy-duty

Model No.	Dim. W" x D"	Platform Type	Wt. lbs.	Price /Each
<b>MEDIUM-DUTY</b>				
MA186	18 x 24	Standard	16.36	139.00
MA187	18 x 24	Carpeted	19.55	209.00
MD515	18 x 30	Standard	18	145.00
MD516	18 x 30	Carpeted	20	225.00
<b>HEAVY-DUTY</b>				
MA188	18 x 24	Standard	20.2	179.00
MA189	18 x 24	Carpeted	18.5	235.00
MD517	18 x 30	Standard	22	205.00
MD518	18 x 30	Carpeted	24	249.00



Model No.	Size W" x D"	Caster Type	Caster Size"	Capacity lbs.*	Price /Each
<b>RUBBER ENDS</b>					
MN191	18 x 24	Polyolefin	3	900	119.00
MN197	18 x 24	Polyurethane	3	900	119.00
MN203	18 x 24	Polyolefin	4	1000	119.00
MN209	18 x 24	Polyurethane	4	1600	150.00
MN215	18 x 24	Blue Elastic	4	1400	145.00
MN194	18 x 30	Polyolefin	3	900	125.00
MN200	18 x 30	Polyurethane	3	900	125.00
MN206	18 x 30	Polyolefin	4	1000	125.00
MN212	18 x 30	Polyurethane	4	1600	158.00
MN218	18 x 30	Blue Elastic	4	1400	152.00

### REPLACEMENT CASTERS

Model No.	Description	Price /Each
ML391	3" Swivel Polyolefin	9.60
ML393	4" Swivel Polyolefin	10.80
MP696	3" Swivel Polyurethane	15.20
ML045	4" Swivel Polyurethane	25.00
ML333	4" Swivel Blue Elastic Rubber	19.45

## MEDIUM-DUTY SOLID WOOD DOLLIES

- 7/8" wood top with countersunk bolts
- 3" polyolefin casters
- Shipped knocked down
- Capacity: 900 lbs. evenly distributed



MP090



MP089



Model No.	Width"	Depth"	Height"	Platform Type	Weight lbs.	Price /Each
MP087	18	24	7	Standard	22	165.00
MP088	18	24	7	Carpeted	23.4	239.00
MP089	18	30	7	Standard	26	183.00
MP090	18	30	7	Carpeted	26.75	259.00

## HEAVY-DUTY SOLID WOOD DOLLIES

- 1-3/4" wood top (2 x 7/8" pieces) with countersunk bolts
- 4" resilient non-marking casters
- Shipped knocked down
- Capacity: 1400 lbs. evenly distributed
- Wheel Material: Rubber



MP093



MP094



Model No.	Width"	Depth"	Height"	Platform Type	Weight lbs.	Price /Each
MP091	18	24	7	Standard	26.25	209.00
MP092	18	24	7	Carpeted	27.8	269.00
MP093	18	30	7	Standard	28.5	229.00
MP094	18	30	7	Carpeted	30.65	295.00



## STEEL DECK DOLLIES

- Rugged dollies ideal for moving heavy loads
- 14-gauge steel construction
- Optional T-handle facilitates movement with heavy loads
- Four bolted-on 4" swivel non-marking rubber casters
- Capacity: 1200 lbs. evenly distributed
- Durable Kleton blue enamel finish

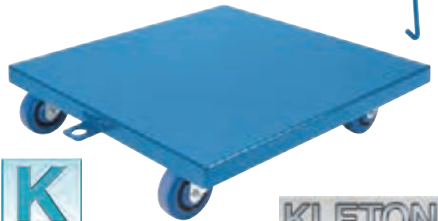

**KLETON**

Model No.	Overall Dimensions				Wt. lbs.	Price /Each
	W"	x	D"	x H"		
MA242	18	x	18	x 7	16	285.00
MA243	18	x	24	x 7	19.55	305.00
MA244	24	x	24	x 7	24.4	319.00
MA199	34" Length T-handle				5.75	129.00

## ANGLE FRAME DOLLIES

- Built to withstand tough factory and warehouse environments
- Heavy-duty all-welded 1/2" x 1/2" x 1/8" angle frame construction
- Four bolted-on 4" swivel non-marking rubber casters
- Capacity: 1200 lbs. evenly distributed
- Durable Kleton blue enamel finish



**KLETON**

Model No.	Overall Dimensions				Wt. lbs.	Price /Each
	W"	x	D"	x H"		
MA190	18	x	18	x 7	19.30	239.00
MA191	18	x	24	x 7	17.80	269.00
MA192	24	x	24	x 7	22.10	249.00
MA193	24	x	36	x 7	22.80	275.00

## DOLLY RACKS

- Converts a basic wood dolly into a multi-purpose panel caddy
- All-welded 1" tube designed for durability
- Tubular steel rack is padded to prevent scratching or marring
- Durable Kleton blue enamel finish
- Between Rail Clearance: 16"



**KLETON**

Model No.	For Use With Wood Dollies	Overall Dim. W" x D" x H"	Wt. lbs.	Price /Each
MD550	30" D	18 x 30 x 43	18.4	249.00

## ALUMINUM DECK DOLLIES

- 3/8" aluminum treadplate construction, countersunk bolts
- 4" resilient non-marking casters
- Capacity: 1200 lbs. evenly distributed



**KLETON**

Model No.	Dimensions			Wt. lbs.	Price /Each
	W"	x	D"		
MA196	18	x	18	20.2	739.00
MA197	18	x	24	25	739.00
MA198	24	x	24	29	779.00

## POLYETHYLENE DOLLIES

- Frame Material: Polyethylene
- Capacity: 1000 lbs. evenly distributed
- Deck Dimensions: 18" W x 30" L
- Deck Height: 6"
- Wheel Material: Rubber
- Steel reinforced structure
- Includes four 4" casters
- Will not splinter or swell
- Round corners and edges
- Rolls easily



MN674



MN675



Model No.	Description	Wt. lbs.	Price /Each
MN674	Flush Top Design	22	175.00
MN675	Padded Top Design	25	205.00

## STEEL LEG DOLLIES

- Ideal for moving furniture with legs
- Includes three 1 1/4" x 13/16" swivel hard polypropylene casters
- Three foam pads on top of dolly help prevent scratching
- Inner cup is 1 3/8" in diameter while the outer cup is 2 1/4" in diameter



MN677



MN678



Model No.	Frame Material	Capacity lbs.	Deck Dimensions W" x D"	Deck Height"	Price /Each
MN677	Steel, Painted Black	200	5.75 x 6.75	2.45	20.50
MN678	Zinc Plated/Steel	300	12 x 10.75	2.75	36.90

## PRY DOLLIES

- Move heavy boxes, die blocks and machinery
- Heavy-duty nose plate gets under the load, 6' steel or wooden handle gives tremendous leverage
- Come with 5" x 2" polyurethane casters
- Use in pairs to move large objects without the need of a separate dolly



MF871



MF870



Model No.	Handle	Cap. lbs.	Nose Plate"	Wt. lbs.	Price /Each
MF870	Wood	4250	7 1/8 x 3 1/8	32	409.00
MF871	Steel	5000	6 x 3 1/2	42	335.00

# PALLET TRUCKS



## HEAVY-DUTY SERIES HYDRAULIC PALLET TRUCKS

Rugged construction makes these pallet trucks the best value for your material handling needs. Up to 27" W x 48" L forks feature entry rollers and tapered design for easy pallet entry and are reinforced for heavy-duty loads. The 3-function hand control (raise, neutral and lower) and the spring-loaded self-righting safety loop handle enhance comfort and ease of operation. Hardened chrome piston with protective dust cover for dependable performance. Durable powder coat finish.



### 5500-LB. CAPACITY HYDRAULIC PALLET TRUCKS

- Heavy-duty polyurethane tread bonded to cast iron core steering wheels and rollers provide superior performance
- 6 1/4" (158.75 mm) wide forks
- Lowered Pallet Truck Height: 2-7/8"
- Raised Pallet Truck Height: 7-3/4"
- Colour: Orange
- **2-year limited warranty**



Model No.	Frame Width"	Fork Length"	Price /Each
MJ484	20 1/2	36	595.00
MJ485	20 1/2	42	595.00
MJ486	20 1/2	48	595.00
MJ487	27	36	595.00
MJ488	27	42	595.00
MJ489	27	48	595.00
ML372*	27	48	595.00

\* All nylon steering wheels and rollers

### 6600-LB. CAPACITY HYDRAULIC PALLET TRUCKS

- Heavy-duty polyurethane tread bonded to cast iron core steering wheels and rollers provide superior performance
- Double rollers for easy moving of extra heavy loads
- Reinforced fork channels deliver exceptional durability
- 6 1/4" (158.75 mm) wide forks
- Lowered Pallet Truck Height: 2-7/8"
- Raised Pallet Truck Height: 7-3/4"
- Colour: Kleton Blue
- **2-year limited warranty**



Forks feature double entry rollers and tapered design for easy pallet entry

Model No.	Frame Width"	Fork Length"	Price /Each
MJ490	20 1/2	36	695.00
MJ491	20 1/2	42	695.00
MJ492	20 1/2	48	695.00
MJ493	27	36	695.00
MJ494	27	42	695.00
MJ495	27	48	695.00
ML373*	27	48	695.00

\* All nylon steering wheels and rollers

## HYDRAULIC PALLET TRUCKS

- Heavy-duty polyurethane tread bonded to cast iron core steering wheels and rollers provide superior performance
- Heavy-duty plastic roller facilitates entry and exit of pallets
- 6 1/4" (158.75 mm) wide forks
- Lowered Pallet Truck Height: 3-1/4"
- Raised Pallet Truck Height: 7-3/4"
- Colour: Yellow
- **1-year limited warranty**



Model No.	Frame Width"	Fork Length"	Capacity lbs.	Price /Each
ML966	20 1/2	36	5500	525.00
ML967	20 1/2	42	5500	525.00
MP794	20 1/2	48	5500	525.00
ML969	27	36	5500	525.00
ML970	27	42	5500	525.00
MP797	27	48	5500	525.00
ML972	27	48	5500	525.00

\* All nylon core steering wheels and rollers

## 6' LONG FORK HYDRAULIC PALLET TRUCKS

- Heavy-duty polyurethane tread bonded to cast iron core steering wheels and rollers provide superior performance
- Nylon exit roller facilitates entry and exit of pallets
- 6 1/4" (158.75 mm) wide forks
- Lowered Pallet Truck Height: 3"
- Raised Pallet Truck Height: 7 5/8"
- Colour: Yellow
- **2-year limited warranty**



Model No.	Frame Width"	Fork Length"	Capacity lbs.	Price /Each
MN723	27	72	3300	895.00
MN459	27	72	5500	1345.00

## SUPER HEAVY-DUTY HYDRAULIC PALLET TRUCK

- Heavy-duty nylon steering wheels and rollers provide maximum mobility and performance
- Double rollers for easy moving of extra heavy loads
- Frame Material: Steel
- Fork Width: 6-1/4"
- Lowered Pallet Truck Height: 3"
- Raised Pallet Truck Height: 5-1/2"
- Colour: Orange
- **2-year limited warranty**



**KLETON**

Model No.	Frame Width"	Fork Length	Capacity lbs.	Price /Each
M0890	27	48	11 000	1450.00

## LOW PROFILE HYDRAULIC PALLET TRUCK

- Permits the handling of pallets and containers that are lower than the standard height
- Heavy-duty polyurethane tread bonded to cast iron core steering wheels and all steel rollers provide superior performance
- 1.5" exit ramp facilitates exit of pallets
- 6" (152 mm) wide forks
- Lowered Pallet Truck Height: 2"
- Raised Pallet Truck Height: 5-1/2"
- Colour: Orange
- **2-year limited warranty**



**KLETON**

Model No.	Frame Width"	Fork Length	Capacity lbs.	Price /Each
MN061	27	48	3300	695.00

## GALVANIZED HYDRAULIC PALLET TRUCKS

- Heavy-duty all nylon steering wheels and rollers provide superior mobility and performance
- Nylon exit roller facilitates entry and exit of pallets
- 6 1/4" (158.75 mm) wide forks
- Lowered Pallet Truck Height: 3"
- Raised Pallet Truck Height: 7-1/16"
- Galvanized finish offers corrosion resistance and is ideal for wet and cold conditions
- **2-year limited warranty**



**KLETON**

Model No.	Frame Width"	Fork Length"	Capacity lbs.	Price /Each
MN059	27	48	5500	845.00
MN648	27	42	5500	830.00

## STAINLESS STEEL HYDRAULIC PALLET TRUCKS

- Heavy-duty all nylon steering wheels and rollers provide superior mobility and performance
- Nylon exit roller facilitates entry and exit of pallets
- 6 1/4" (158.75 mm) wide forks
- High grade 304 stainless steel is ideal for medical, food, sanitary, pharmaceutical, wet and cold applications
- Features stainless steel forks, frame and handle
- Lowered Pallet Truck Height: 3"
- Raised Pallet Truck Height: 7-1/16"
- **2-year limited warranty**



**KLETON**

Model No.	Frame Width"	Fork Length"	Capacity lbs.	Price /Each
MN060	27	48	5500	3050.00

## DIGITAL SCALE PALLET TRUCK

- Permits the weighing of skids and containers while handling them
- Mettler Toledo digital cUL approved scale offers maximum precision on load weights
- Heavy-duty polyurethane tread bonded to cast iron core steering wheels and rollers provide superior performance
- Nylon roller facilitates entry and exit of pallets
- 6 5/8" wide forks
- Lowered Truck Height: 3"
- Raised Truck Height: 7-11/16"
- **2-year limited warranty**



**KLETON**

Model No.	Frame Width"	Fork Length"	Capacity lbs.	Price /Each
MN705	27	44 1/2	4400	2595.00

## MULTI-DIRECTIONAL HYDRAULIC PALLET TRUCK

- Transrollers permit lateral movement in addition to forward/backward
- Heavy-duty polyurethane tread bonded to cast iron core steering wheels provide superior performance
- Double load rollers, one polyurethane tread bonded to cast iron core and one nylon for easy moving of extra heavy loads
- 2 1/5" exit ramp facilitates exit of pallets
- 6 1/4" (158.75 mm) wide forks
- Lowered pallet truck height: 3"
- Raised Pallet Truck Height: 7-1/2"
- Capacity: Up to 5500 lbs. in standard mode and up to 3300 lbs. in lateral mode
- Colour: Orange
- **2-year limited warranty**



**KLETON**

Model No.	Frame Width"	Fork Length"	Capacity lbs.	Price /Each
MN062	27	48		735.00



# PALLET TRUCKS



## QUICK-LIFT HYDRAULIC PALLET TRUCK

- Lifts to full height with only four pumps when empty
- Two-speed pump automatically switches to low-speed operation
- Allows forks to quickly rise to upper pallet boards for quicker operation
- Ships pre-assembled
- Frame Material: Steel
- Fork Width: 6-1/4"
- Raised Height: 7.5"
- Lowered Height: 3"
- Wheel Material: Poly on Steel

Model No.	Frame Width"	Fork Length"	Capacity lbs.	Price /Each
MP775	20	48	5500	595.00
MP776	27	48	5500	595.00



KLETON

## FULLY POWERED ELECTRIC PALLET TRUCKS

- Raise and lower loads with a push of a button
- Ergonomic handle features easy to operate throttle, lift/lower controls, safety-enhancing emergency reverse function and horn
- Includes electromagnetic disc brake with automatic dead-man feature that activates when handle is released
- Uses two (2) 12V batteries, integral battery charger and battery level gauge
- Frame Material: Steel



Model No.	Fork Height		Frame Width"	Fork Length"	Fork Width"	Batteries	Motor		Operation Time (hours)	Intermittent Operation Time (hours)	Capacity lbs.	Price /Each
	Lowered"	Raised"					Drive	Lift				
LV531	3.2	7.8	28.25	47	20	(2) 12V batteries	0.7 KW	1.3 KW	3-4	8	3300	8989.00
LV532	3.4	7.8	30.25	48	20	(4) 6V batteries	1.2 KW	2.0 KW	6-7	8	4500	12185.00
LV533	3.1	7.8	28.25	48	25	(2) 12V batteries	0.7 KW	1.3 KW	3-4	8	3300	9025.00
LV534	3.1	7.8	25	47	25	(2) 12V batteries	0.7 KW	1.3 KW	3-4	8	3000	8399.00
LV535*	3.1	7.8	28.25	48	25	(2) 12V batteries	0.7 KW	1.3 KW	3-4	8	3300	13129.00
LV536	3.2	8.2	30.25	48	27	(4) 6V batteries	1.2 KW	2.0 KW	6-7	8	4500	12649.00
LV538*	3.2	8.2	30.25	48	27	(4) 6V batteries	1.2 KW	2.0 KW	6-7	8	4500	16235.00

\*Features a built-in scale

## MANUAL SCISSOR SKID LIFT

- Closed Fork tips and reinforced chassis ensure long-lasting performance
- Ergonomically designed and comfortable handle
- Single cylinder for increased durability and less maintenance
- Capacity: 3300 lbs.
- Raised Height: 31.5"
- Lowered Height: 3.35"
- Frame Material: Steel
- Wheels/Rollers: Polyurethane
- Extended Mast Height: 65.5"



KLETON

Model No.	Platform Dimensions	Price /Each
MP565	20-1/4" L x 45-1/4" W	1425.00
MP566	27" L x 45-1/4" W	1425.00

## ELECTRIC SKID LIFTS

- Ergonomic lift truck increases worker and machine efficiency and productivity
- Reduces operator muscle fatigue and injuries by bringing material closer to worker height
- Heavy loads can be lifted using push buttons and electric hydraulic power and moved until auto brake engages at approximately 8"
- Unit rolls on phenolic 8" x 3" rear swivel casters and dual 3" front guide wheels
- Capacity: 2500 lbs.
- Raised Height: 31.5"
- Lowered Height: 3.5"
- Frame Material: Steel



Model No.	Platform Dim. W" x L"	Operation Type	Description	Price /Each
LV544	27 x 48	AC Powered	Push Button Hand Control	5999.00
LV545	27 x 48	Air/Oil Powered	Foot Treadle Control	5999.00
LV546	27 x 48	DC Powered	Push Button Hand Control & On-Board Charger	5999.00

## FULLY POWERED ELECTRIC PALLET TRUCK WITH STAND-ON PLATFORM

- Raise and lower loads with a push of a button
- Ergonomic handle features easy to operate throttle, lift/lower controls, safety-enhancing emergency reverse function and horn
- Includes electromagnetic disc brake with automatic dead-man feature that activates when handle is released
- Uses four (4) 6V batteries, integral battery charger, battery level gauge and emergency battery disconnect
- Features 1.2 KW drive and 2.0 KW lift motor
- 6-7 hours operation at full charge - 8 hours when used intermittently
- CUL approved charger
- Capacity: 4500 lbs.
- Frame Material: Steel
- Fork Width: 27"
- Machine Weight: 1116 lbs.



Model No.	Fork Height		Fork Length"	Frame Width"	Price /Each
	Lowered"	Raised"			
LV537	3.2	8.2	48	30-1/4	13095.00

## FULLY POWERED ELECTRIC PALLET TRUCK WITH STAND-ON PLATFORM

- Raise and lower loads with a push of a button
- Ergonomic handle features easy to operate throttle, lift/lower controls, safety-enhancing emergency reverse function and horn
- Includes electromagnetic disc brake with automatic dead-man feature that activates when handle is released
- Uses four (4) 6V batteries, integral battery charger, battery level gauge and emergency battery disconnect
- Features 1.2 KW drive and 2.0 KW lift motor
- 6-7 hours operation at full charge - 8 hours when used intermittently
- CUL approved charger
- Capacity: 4500 lbs.
- Frame Material: Steel
- Fork Width: 27"
- Machine Weight: 1582 lbs.



Model No.	Fork Height		Fork Length"	Frame Width"	Price /Each
	Lowered"	Raised"			
LV539	3.2	8.2	96	30	17185.00

## HEAVY-DUTY BRAKE PALLET TRUCK

- Heavy-duty polyurethane tread bonded to cast iron core steering wheels and rollers provide superior performance
- Constructed with a hand brake
- Fork Length: 48"
- Frame Width: 27"
- Capacity: 5500 lbs.
- Frame Material: Steel
- Fork Width: 6.25"
- Raised Height: 7.75"
- Lowered Height: 2.9"
- Colour: Orange
- Manufacturer's Warranty: 2 Years Limited

Model No. MP611  
Price/Each \$695.00



## PALLET TRUCK CHOCK

- Reduce freight claims and trailer damage caused by runaway pallet trucks
- Roll the pallet truck's wheels up the incline into the holding area
- The pallet jack stop functions on any surface without slipping
- Material: Rubber
- Colour: Black
- Dimensions: 345 mm x 295 mm x 55mm

Model No. KI297  
Price/Each \$59.95



## 4-WAY HYDRAULIC PALLET TRUCK

- Can enter pallet from all 4 sides
- Reinforced forks
- Adjustable fork connecting rods
- Steel 1.70" load wheels
- 6" polyurethane steering wheels
- Capacity: 4000 lbs.
- 3-year pump warranty



Model No.	Mfg. No.	Frame Width"	Fork Length"	Wt. lbs.	Price /Each
MN136	273400	33	48	241	1909.00

## ADJUSTABLE WIDTH PALLET TRUCKS

- Fork width adjusts from 21" to 27"
- Fork Length: 48"
- 7" mold-on polyurethane steering wheel
- 3" mold-on polyurethane load wheels
- Raised Height: 7 3/4"
- Lowered Height: 3"
- Forks Width: 6"
- Capacity: 5500 lbs.
- 5-year pump warranty

Model No. MI820 Price/Each \$1889.00

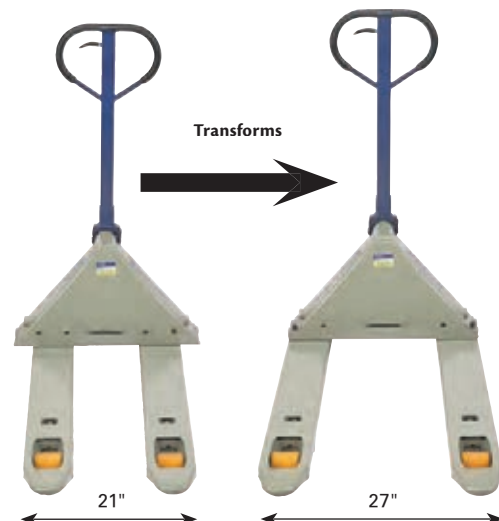

# PALLET TRUCKS

## ALL TERRAIN PALLET TRUCKS

- Welded steel tubular frame construction for maximum strength
- Features large pneumatic wheels for use on gravel, dirt and other types of rough terrain
- Wheels include sealed bearings for dust protection and long life
- Overall Fork Length: 32"
- Fork Lowered Height: 3"
- Fork Raised Height: 9"
- Overall Dimensions: 64" W x 50" L x 51" H
- Usable straddle width is 50" between outriggers
- Rear Wheel Diameter: 10"
- **90-day limited warranty**



Model No.	Overall Fork Width"	Capacity lbs.	Weight lbs.	Price /Each
MN461	9-1/2 - 26	2000*	239	2665.00
MN463	Optional Tow Bar Package		20	275.00

\* 2000 lbs. at 12" horizontal load center, 1500 lbs. at 15" and 1000 lbs. at 24"

## QUICK LIFT HYDRAULIC PALLET TRUCKS

- Lifts to full height with only four pumps when empty
- 2-speed pump automatically switches to low-speed operation
- Allows forks to quickly rise to upper pallet boards for quicker operation
- Each fork measures 7" wide
- Poly-on-steel wheels
- Assembly required to connect handle to truck



Model No.	Fork Height		Frame Width"	Fork Length"	Capacity lbs.	Price /Each
	Lowered"	Raised"				
MN365	3	7 1/2	20	48	5500	985.00
MN366	3	7 1/2	27	48	5500	939.00



## PALLET JACK STOPS

- Ideal solution for reducing freight claims and trailer damage caused by runaway pallet trucks
- Engineered for tough duty inside trucks and trailers
- The pallet jack stop functions on any surface without slipping

Model No. MN083  
Mfg. No. 272175  
Price/Each \$119.00



## PALLET PULLERS

- Efficient way to unload pallets from trucks
- Hardened teeth give positive grip in any pallet
- One-person operation
- Pulls pallets straight or sideways to get out of tight spots
- Puller Capacity: 5000 lbs.
- Chain Capacity: 4700 lbs.
- Max Jaw Opening: 9-1/4"
- Jaw Height: 3"
- Colour: Blue



KH863



LU982



Model No.	Description	Wt. lbs.	Price /Each
KH863	Pallet Puller	16	119.00
LU982	Grade 70 Transport Chain, Length: 20', Trade Size: 5/16"	21	136.00

## FORKLIFT SAFE BUMP GUARDS

- Avoid damage to forklift trucks
- Safe-Bump attaches with two 100 lb magnets and (VHB) two way tape
- Made of soft PVC plastic that will absorb energy to prevent damage
- Can be attached to the forks to prevent handling damage
- Dimensions: 18" L x 4" W x 1.5" H

Model No. LU441  
Price/Each \$185.00



## FORKLIFT BATTERY PPE KITS

- Occupational Health and Safety laws require that all personnel wear personal protective equipment (PPE) when performing all battery maintenance or replacement
- Kit includes: neoprene safety handling gloves, safety goggles/eye protection, face safety shield/eye protection, apron, flashlight, battery hydrometer, battery handling mounting board

Model No. LU438  
Price/Each \$279.00





# FORK LIFT ACCESSORIES & ATTACHMENTS

## FORK EXTENSIONS

- Handle large and odd shaped loads with increased stability
- Easy to use slide-on design
- Steel retaining strap prevents extensions from sliding off forks during use
- Fork extension may not extend more than 50% beyond existing fork
- Accommodates forks with maximum fork thickness of 2"
- Max. Fork Thickness: 2"
- Fork Extension Capacity: 4000 lbs.



**KLETON**



Price per Pair

Model No.	Accommodates Fork Width"	Fork Extension Overall Width"	Length"	Wt. lbs.	Price /Each
M0778	4	5	54	84	325.00
M0779	4	5	63	98	365.00
ML346	4	5	72	114	395.00
M0780	4	5	84	145	495.00
ML348	4	5	96	172	549.00
M0781	5	6	63	110	389.00
ML347	5	6	72	128	455.00
M0782	5	6	84	145	515.00
M0783	5	6	96	165	595.00
M0784	6	7	72	134	499.00
M0785	6	7	84	158	615.00
M0786	6	7	96	180	755.00

## WALL BRACKET

- To keep fork extensions out of the way when not in use
- One wall bracket required for each pair of forks

**KLETON**

Model No.	Dimensions W" x H"	Wt. lbs	Price /Each
ML282	6 x 8	5	129.00

Note: Hardware not included



## FORKLIFT MIRRORS

- Know what is going on all around the lift truck at all times
- High range of visibility
- Installation on any lift truck is quick and easy

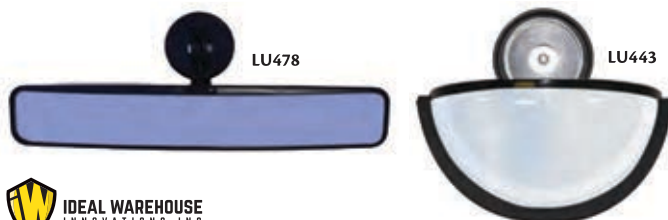

**IDEAL WAREHOUSE INNOVATIONS INC**

Model No.	Shape	Size"	Mounting Type	Price /Each
LU478	Rectangular	18-1/4 W x 3 H	Magnet	149.00
LU479	Rectangular	8 W x 4-1/4 H	Magnet	149.00
LU442	Dome	9 Dia.	Tape	125.00
LU443	Dome	9 Dia.	Magnet	159.00

## FORKLIFT REAR SPOTTER

- Provides visual warning for pedestrians; promotes greater safety
- Configured for 12-48 VDC
- Bright blue spot beam pattern projects onto the ground
- IP67 Standard Compliance (Dust & Water Resistant)
- UV-resistant polycarbonate lens
- Mounting hardware M10 - 1.5 x 20 mm
- Optional universal mounting kit (see XE492)

**IDEAL WAREHOUSE INNOVATIONS INC**

XE490



Model No.	Lens Pattern	Lens Material	Housing Material	Connector	Price /Each
XE490	Spot	Polycarbonate	Aluminum	Wire Harness	165.00
XE492			Universal Mount		10.90

## FORK TILT LEVEL INDICATORS

An incorrect tilt angle of a lift truck's forks is the leading cause of damage to pallets, racking and merchandise. Even the most experienced operators have difficulty judging the correct fork tilt when placing pallets high onto racking. That's why Accu-Tilt displays the fork level at all times to prevent damage and increase productivity by eliminating the guess work.

Additionally, the Accu-Tilt's fork tilt level indicator also specifies the correct fork angle to use when moving a load and when parking the lift truck. This valuable device is easily installed on all makes and models of forklifts and lift trucks.

Model No. MN261  
Price/Each \$295.00



**IDEAL WAREHOUSE INNOVATIONS INC**

## FORKLIFT & WORK PLATFORM CHECKLIST CADDY KITS

- A complete daily checklist system for operators
- Log Kits Include:
  - (1) 75 inspection carbon copy sheet checklist pad
  - (1) pen with attached plastic wire
  - (1) 4-1/4" x 7-1/4" polyethylene envelope with two way tape



**IDEAL WAREHOUSE INNOVATIONS INC**

Model No.	Forklift Type	Version	Language	Price /Each
LU454	Propane Counterbalance	Complete Log Kit	English	63.50
LU455	Electric Counterbalance	Complete Log Kit	English	63.50
LU456	Electric Narrow Aisle	Complete Log Kit	English	63.50
LU457	Electric Pallet Truck	Complete Log Kit	English	63.50
LU458	Aerial Work Platform	Complete Log Kit	English	62.90
LU468	Propane Counterbalance	Complete Log Kit	French	63.50
LU469	Electric Counterbalance	Complete Log Kit	French	63.50
LU470	Electric Narrow Aisle	Complete Log Kit	French	63.50
LU471	Electric Pallet Truck	Complete Log Kit	French	63.50
LU472	Aerial Work Platform	Complete Log Kit	French	64.50
LU459	Propane Counterbalance	Replacement Log Book	English	23.90
LU460	Electric Counterbalance	Replacement Log Book	English	23.90
LU461	Electric Narrow Aisle	Replacement Log Book	English	23.90
LU462	Electric Pallet Truck	Replacement Log Book	English	23.90
LU463	Aerial Work Platform	Replacement Log Book	English	23.90
LU473	Propane Counterbalance	Replacement Log Book	French	23.90
LU474	Electric Counterbalance	Replacement Log Book	French	23.90
LU475	Electric Narrow Aisle	Replacement Log Book	French	23.90
LU476	Electric Pallet Truck	Replacement Log Book	French	23.90
LU477	Aerial Work Platform	Replacement Log Book	French	22.90

# LIFT TABLES

## HYDRAULIC SCISSOR LIFT TABLES



Kleton tables are available in various capacities and travels to satisfy a wide variety of applications. All tables have an integrated hydraulic pump/cylinder assembly. Kleton scissor lift tables add the value of mobility to the hydraulic lift table concept. Exceptional functionality and manoeuvrability is apparent, whether loaded or empty. In addition, rugged construction and premium-quality hydraulics complement their ease of use with low maintenance.

### APPLICATIONS

Kleton tables are used in a wide variety of applications, from stocking shelves to lifting and moving materials in warehouses, machine shops and manufacturing operations.

### OPERATION

The Kleton design allows workers to easily move and position loads to a convenient working height. By minimizing undesirable lifting, reaching and stretching, Kleton tables increase productivity and decrease workplace injuries.

### STANDARD FEATURES

- Ergonomic push handle with easy to use release handle to lower the platform
- Hydraulic foot pump raises the platform
- Quality orange powder coated finish provides exceptional durability and corrosion resistance
- (2) rigid polyurethane casters
- (2) swivel polyurethane casters with brake



MP005



MP006



MP007



MP008



FIND OUT HOW IT WORKS

[www.Youtube.com/KletonInd](http://www.Youtube.com/KletonInd)

Model No.	Load Cap. lbs.	Platform Height		Platform Size		Handle Height"	Pedal Strokes To Max	Wheel Diameter"	Weight lbs.	Price /Each
		Lowered"	Raised"	Width"	Length"					
MP005	330	8.85	29.13	17 3/4	27 1/2	36.8	25	4	92.5	599.00
MP006	660	11	35.4	19 3/4	32	39.2	36	5	169.7	789.00
MP007	770	13.7	51.1	19 3/4	35 3/4	38.1	60	5	275	1099.00
MP008	1100	11	35.4	19 3/4	32	39.2	45	5	187.3	919.00

Note: Platform height dimensions include the casters.

## HYDRAULIC SCISSOR LIFT TABLES



Kleton tables are available in various capacities and travels to satisfy a wide variety of applications. All tables have an integrated hydraulic pump/cylinder assembly. Kleton scissor lift tables add the value of mobility to the hydraulic lift table concept. Exceptional functionality and manoeuvrability is apparent, whether loaded or empty. In addition, rugged construction and premium-quality hydraulics complement their ease of use with low maintenance.

### APPLICATIONS

Kleton tables are used in a wide variety of applications, from stocking shelves to lifting and moving materials in warehouses, machine shops and manufacturing operations.

### OPERATION

The Kleton design allows workers to easily move and position loads to a convenient working height. By minimizing undesirable lifting, reaching and stretching, Kleton tables increase productivity and decrease workplace injuries.

### STANDARD FEATURES

- Ergonomic push handle with easy to use release handle to lower the platform
- Hydraulic foot pump raises the platform
- Quality orange powder coated finish provides exceptional durability and corrosion resistance
- (2) rigid polyurethane casters
- (2) swivel polyurethane casters with brake



MP009



MP010



MP011



MP012



FIND OUT HOW IT WORKS

[www.Youtube.com/KletonInd](http://www.Youtube.com/KletonInd)

Model No.	Load Cap. lbs.	Platform Height		Platform Size		Handle Height"	Pedal Strokes To Max	Wheel Diameter"	Weight lbs.	Price /Each
		Lowered"	Raised"	Width"	Length"					
MP009	1100	12.2	35.4	31 1/2	63	38.1	55	5	299.8	1569.00
MP010	1650	16.5	39.3	20	39 1/2	39.2	70	6	227	1149.00
MP011	2200	14.9	39.3	20	40	37.8	55	6	253.5	1199.00
MP012	1540	18.7	59	24	48	37.8	70	6	379	1625.00

Note: Platform height dimensions include the casters.



# LIFT TABLES

## HEAVY-DUTY HYDRAULIC SCISSOR LIFT TABLES



Kleton tables are available in various capacities and travels to satisfy a wide variety of applications. All models have an integrated hydraulic pump/cylinder assembly. The Kleton scissor lift tables add the value of mobility to the hydraulic lift table concept. Exceptional functionality and manoeuvrability is apparent, whether loaded or empty. In addition, rugged construction and premium-quality hydraulics complement their ease of use with low maintenance.

### APPLICATIONS

Kleton tables are used in a wide variety of applications, from stocking shelves in retail stores to lifting and moving materials in warehouses, machine shops and manufacturing operations.

### OPERATION

The Kleton design allows workers to easily move and position loads to a convenient working height. By minimizing undesirable lifting, reaching and stretching, Kleton tables increase productivity and decrease workplace injuries.

### STANDARD FEATURES

- Heavy-duty construction with captured scissor rollers for maximum stability
- Superior hydraulic systems feature an integrated pump-cylinder for maximum reliability
- High quality casters and wheels for exceptional roll ability (two fixed, two swivel)
- Ergonomic push handle with convenient lowering control
- Lowering control automatically stops when released for added safety
- Convenient maintenance pins secure the scissor legs for inspection and maintenance on larger models
- Quality powder coated finish provides exceptional durability and corrosion resistance
- Colour: Kleton Blue



MJ518



MJ519



MJ520



MJ522



FIND OUT HOW IT WORKS

[www.Youtube.com/KletonInd](http://www.Youtube.com/KletonInd)

Model No.	Load Cap. lbs.	Platform Height		Platform Size		Handle Height"	Pedal Strokes To Max	Weight lbs.	Price /Each
		Lowered"	Raised"	Width"	Length"				
MJ518	330	8 5/8	29	17 3/4	27 1/2	37 3/8	28	94.6	749.00
MJ519	660	11 1/4	34 5/8	19 3/4	32	39	27	151	989.00
MJ520	770	14	51 1/4	19 3/4	35 3/4	38 3/8	53	220	1375.00
MJ521	1100	11 1/4	34 5/8	19 3/4	32	39	27	173	1149.00
MJ522	1100	11 1/4	36	31 7/8	63	39	55	341	1960.00

Note: Platform height dimensions include the casters.

## HEAVY-DUTY HYDRAULIC SCISSOR LIFT TABLES



Kleton tables are available in various capacities and travels to satisfy a wide variety of applications. All models have an integrated hydraulic pump/cylinder assembly. The Kleton scissor lift tables add the value of mobility to the hydraulic lift table concept. Exceptional functionality and manoeuvrability is apparent, whether loaded or empty. In addition, rugged construction and premium-quality hydraulics complement their ease of use with low maintenance.

### APPLICATIONS

Kleton tables are used in a wide variety of applications, from stocking shelves in retail stores to lifting and moving materials in warehouses, machine shops and manufacturing operations.

### OPERATION

The Kleton design allows workers to easily move and position loads to a convenient working height. By minimizing undesirable lifting, reaching and stretching, Kleton tables increase productivity and decrease workplace injuries.

### STANDARD FEATURES

- Heavy-duty construction with captured scissor rollers for maximum stability
- Superior hydraulic systems feature an integrated pump-cylinder for maximum reliability
- High quality casters and wheels for exceptional roll ability (two fixed, two swivel)
- Ergonomic push handle with convenient lowering control
- Lowering control automatically stops when released for added safety
- Convenient maintenance pins secure the scissor legs for inspection and maintenance on larger models
- Quality powder coated finish provides exceptional durability and corrosion resistance
- Colour: Kleton Blue



MJ523



MJ524



MJ525



MJ526



**FIND OUT HOW IT WORKS**  
[www.Youtube.com/KletonInd](http://www.Youtube.com/KletonInd)

Model No.	Load Cap. lbs.	Platform Height		Platform Size		Handle Height"	Pedal Strokes To Max	Weight lbs.	Price /Each
		Lowered"	Raised"	Width"	Length"				
MJ523	1650	14 1/2	35 3/8	20 1/8	39 3/8	39 3/8	45	264	1435.00
MJ524	2200	15	39	20 1/8	40	38 5/8	82	272	1499.00
MJ525	2200	15	53 1/2	29 1/2	80 1/8	39 3/8	200	682	2955.00
MJ526	1545	17 1/2	59 1/8	24	48	40	97	430	2299.00

**Note:** Platform height dimensions include the casters.

# LIFT TABLES

## DANDY LIFT™ LIFT TABLES

- Dandy Lift™ offers the ideal solution to reliable, economic lifting over years of service
- Pivot points have hardened pins in lifetime lubricated bearings
- Simple grouped controls make tables easy to operate
- Hard chrome-plated pistons and rods resist rust and corrosion for dependability and long life
- Honed heavy-walled cylinders improve both seal performance and durability



## SOUTHWORTH

Model No	Mfg. No.	Capacity lbs.	Platform Height		Platform Size		Overall Size		Foot Pedal Strokes to Max.	Wt. lbs.	Price /Each
			Lowered"	Raised"	Width"	Length"	Width"	Length"			
MA431	L-150	330	8 3/10	29	17 7/10	28	17 7/10	37 7/10	14	82	1615.00
MA432	L-250	550	9 1/2	31 4/5	19 7/10	31 1/2	19 7/10	38 1/5	20	115	1839.00
MA421	A-350W	770	13 3/5	49 4/5	23 3/5	35 4/5	23 3/5	42 1/10	45	229	3525.00
MA422	A-500	1100	11 4/5	36 3/5	23 3/5	35 4/5	23 3/5	42 1/10	45	194	2615.00
MA423	A-800	1760	13	40 1/5	23 3/5	39 2/5	23 3/5	45 9/10	56	275	3285.00

# KLETON



CANADA'S LEADING MATERIAL HANDLING SUPPLIER

Do you have a special application? Not a problem!  
**KLETON specializes in custom requests.**

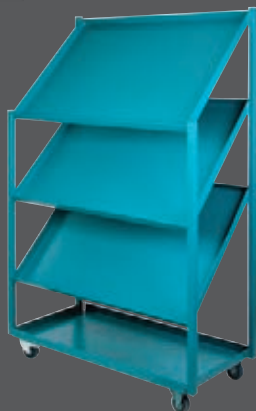

Look for this symbol throughout the catalogue.



Don't see what you're looking for? Contact us, we'll be pleased to help you out.



## HYDRAULIC WORK TABLES

- All-welded construction
- Foot operated lifts are ideal for a wide variety of shop functions (lifting dies, transporting heavy parts and positioning materials)
- Hand operated lever lowers the table level and controls the rate of descent
- Telescoping posts for stability and support
- Tops and bases are 3/16" thick steel
- Floor lock ensures table remains in place when loaded
- Two rigid and two swivel bolted-on casters
- 1-year guarantee



MA433



MA434



MA440



Model No.	Mfg. No.	Capacity lbs.	Table Size			Lowered Height"	Raised Height"	Caster Size"	No. of Support Posts	Wt. lbs.	Price /Each
			L"	x	W"						
MA433	260059	200	16	x	16	28 1/2	46	3	0	54	1379.00
MA434	260060	500	18	x	18	30 1/2	47 1/2	4	2	122	2299.00
MA435	260061	1000	18	x	36	30 1/2	47 1/2	4	2	168	2829.00
MA442	260062	2000	36	x	24	30 1/2	47 1/2	4	4	308	3739.00
MA443	260063	2000	48	x	32	30 1/2	47 1/2	4	4	350	4849.00
MA436	260064	2000	36	x	24	37	59	6	4	339	3629.00
MA437	260065	2000	48	x	32	37	59	6	4	465	4149.00
MA438	260066	4000	36	x	24	37	59	6	4	349	3999.00
MA439	260067	4000	48	x	32	37	59	6	4	475	4259.00
MA440	260068	6000	36	x	24	37	59	6	4	359	3959.00
MA441	260069	6000	48	x	32	37	59	6	4	485	4429.00

## MOBILIFT™ BXB ELECTRIC SCISSOR LIFT TABLES

- Allow workers to easily move and position loads to a convenient working height at the push of a button
- Heavy-duty construction combined with captured scissor rollers provide maximum stability
- Superior hydraulic systems feature an integrated pump-cylinder for maximum reliability
- Convenient maintenance pins provide security by securing the legs during inspection and maintenance
- Quality blue baked enamel finish for durability and corrosion resistance
- Includes: An enclosed 24 V, 3 A charger with removable power cord and three level indicator lights to provide quick indication of charge



Model No	Capacity lbs.	Platform Height		Platform Size		Time to Max Height sec	Wt. lbs.	Price /Each
		Lowered"	Raised"	Width"	Length"			
MK814	660	11 1/2	35	19 7/10	32 1/10	10	280	6219.00
MK815	1100	17 1/5	40 2/5	20 1/2	39 4/5	10	390	6759.00
MK816	1760	17 1/5	38 2/5	20 1/2	39 4/5	12	400	6939.00

## PNEUMATIC HYDRAULIC SCISSOR LIFT TABLES

- Raise and lower material quickly and easily with hydraulic scissor carts
- Features two speed foot pump and hand held reciprocating air/oil power to manipulate platform height
- Carts roll smoothly on two rigid and two swivel poly casters
- Mechanical screw drive provides precise platform positioning with no downward drift
- Frame Material: Steel



LV470



LV474



Model No.	Mfg. No.	Capacity lbs.	Platform Dim.			Lowered Height"	Raised Height"	Wt. lbs.	Price /Each
			L"	x	W"				
LV469	AIR-1000	1000	32-1/2	x	19-3/4	15.75	35.5	180	1839.00
LV470	AIR-1000-LD	1000	63	x	31-1/2	12.1	35.5	318	2845.00
LV471*	AIR-1000-LD-PSS	1000	63	x	31-1/2	12.1	35.5	340	5575.00
LV472*	AIR-1000-PSS	1000	32-1/2	x	19-3/4	15.75	35.5	181	4089.00
LV473	AIR-100-D	1500	47-1/4	x	24	19.5	67	538	3199.00
LV474*	AIR-1500D-PSS	1500	47-1/4	x	24	19.5	67	515	8179.00
LV475	AIR-1750	1750	39-1/2	x	20	14.25	39.5	312	2279.00
LV476	AIR-2000	2000	47-1/2	x	24	15	39.5	400	2505.00
LV477*	AIR-2000-PSS	2000	47-1/2	x	24	15	39.5	394	6109.00
LV478	AIR-800-D	800	35-1/2	x	20	15	51	272	2199.00
LV479*	AIR-800-D-PSS	800	35-1/2	x	20	13.75	51	267	4825.00

\*Partially stainless steel cart features stainless steel platform, frame, handle, caster rigs and hardware

# LIFT TABLES



## OPTIMUS® ELECTRIC-HYDRAULIC SCISSOR LIFT TABLES

- Intelligent design with rounded platform corners
- Unitized power unit with easy-view hydraulic reservoir
- Hinged maintenance bars are powder-coated for improved safety
- Voltage: 115 V
- Current: AC
- Frame Material: Steel



Model No.	Mfg. No.	Lift Vertical Travel"	Height		Platform Dimensions L" x W"	Capacity lbs.	Price /Each
			Raised"	Lowered"			
LV450	L2K-2848	30	38.5	8.5	48 x 28	2000	7649.00
LV451	L2K-3648	30	38.5	8.5	48 x 36	2000	8349.00
LV452	L2K-TT	30	41.5	11.5	43 x 43	2000	8625.00
LV453	L3K-2848	34	42.6	8.6	48 x 28	3000	8445.00
LV454	L3K-3648	34	42.6	8.6	48 x 36	3000	8805.00
LV455	L3K-TT	34	45.8	11.8	43 x 43	3000	9405.00



LV451

## STRADDLED ERGONOMIC TILTERS

- Functions as transporter by moving products from work station to work station without the need for a truck or lift table
- Features a folding ergonomic handle for quick and easy manoeuvrability
- Thin profile allows user to get as close to the load as possible
- Can be used with any kind of container, pallet or skid
- Dimensions: 72-13/16" L x 57-1/4" W x 29-1/4" H
- Fork Length: 28-1/2"
- Raised Height: 37"
- Lowered Height: 3"



Model No.	Mfg. No.	Operation Type	Capacity lbs.	Machine Weight lbs.	Price /Each
LV594	TMS-20-DC	DC Powered	2000	1017	8935.00
LV598	TMS-40-DC	DC Powered	4000	1046	9525.00
LV600	TMS-60-DC	DC Powered	6000	1067	10325.00



## HYDRAULIC SCISSOR LIFT TABLES

- Suitable for a wide range of applications and operating environments
- Two button hand control allows for easy adjustment of platform height (3/4" recommended) for convenient usage
- Toe guards ensure safety of operator
- Capacity: 3000 lbs.
- Raised Height: 43"
- Lowered Height: 7"
- Frame Material: Steel



Model No.	Mfg. No.	Platform Dimensions		Machine Weight lbs.	Price /Each
		Length"	Width"		
LV464	AHLT-2448-3-43	48	24	689	9349.00
LV465	AHLT-3060-3-43	60	30	787	9349.00
LV466	AHLT-4048-3-43	48	40	769	9349.00
LV467	AHLT-4848-3-43	48	48	780	9349.00
LV468	AHLT-4872-3-43	72	48	937	9349.00

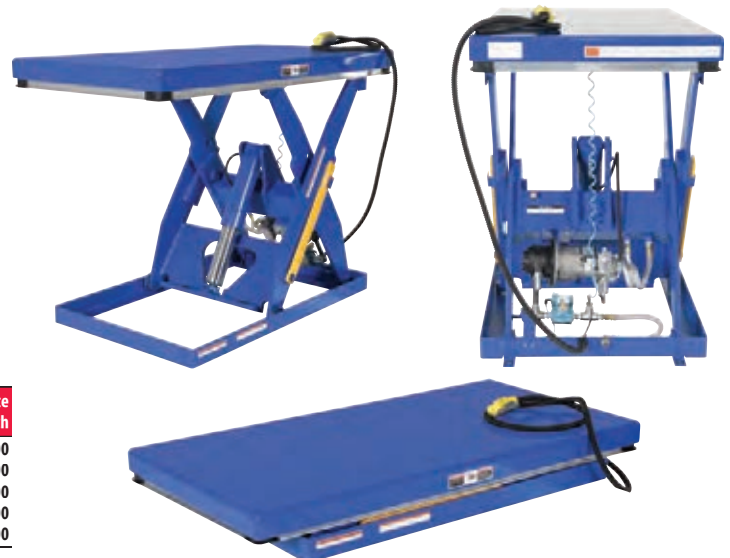

## EZ LOADER®

- Minimizes bending and lifting and reduces extra movement around the pallet
- Weight sensitive, raises and lowers pallet as load weight changes, keeping top of the load at convenient working height
- Rotating top minimizes walking or reaching during the loading process
- Allows on or off loading to be done from near side and at convenient height
- 3-position capacity, adjustable without changing air pressure
- Designed to work in conjunction with Bishamon's Unilift custom easy-to-read air gauge
- Air pressure capacity adjustment: 10-60 PSI
- Shop air requirements: Clean dry air 60 PSI
- Heavy-duty, structural steel frame is 24 1/3" x 49" at base; turntable is 43" in diameter
- Product Weight: 500 lbs.
- Lift Vertical Travel: 20"
- Min. Self Leveling Capacity: 250 lbs.
- Maximum Internal Air Pressure: 135 PSI
- Max. Self Leveling Capacity: 3500 lbs.
- Capacity: 4000 lbs.
- Raised Height: 30.5"
- Lowered Height: 10.5"



LT459



Model No.	Mfg. No.	Description	Frame Material	Price /Each
LT459	EZ-LOADER	Pallet Lifter	Steel	6765.00
LV437	EZ LOADER-E	Self-Leveling Pallet Positioner Stainless Platform	Steel	11189.00
LV438	EZ-LOADER-SS	Self-Leveling Pallet Positioner 100% Stainless Steel	Stainless Steel	23145.00

## AIR PALLET PAL LEVEL LOADER

- Designed for use where pallet loads vary and are changed frequently
- 43 5/8" diameter rolled angle ring riding on low friction bearings and guided by center shaft
- Permanent spring combines with air bag to provide linear response
- Equipped with fork pockets for easy relocation
- Lowered height of 9 1/2", raised height of 30 1/2"
- Base Frame Dimensions: 48" L x 36" W, including fork truck pockets
- Capacity: 400 to 4500 lbs.
- Weight: 460 lbs.

Model No. LT471  
Price/Each \$5959.00



## SPRING-OPERATED PALLET LIFTERS – PALLET PAL®

- Designed to handle loads up to 4500 lbs
- Travel height ranges from 9 1/2" to 28"
- Heavy-duty springs and shock absorbers enables pallet to automatically raise and lower loads as items are added or removed from the platform
- Turntable design provides ergonomic assistance
- Use of lifter reduces the risk of fatigue and work related injuries
- Features built-in fork pockets
- Platform Dimensions: 43-5/8" L x 43-5/8" W



MF108



Model No.	Description	Wt. lbs.	Price /Each
MF108	Steel	400	4409.00
MK836	Stainless Steel	500	28059.00

## SPRING-OPERATED PALLET LIFTER

- Shock absorber and heavy-duty springs allow the top of the load to remain at a convenient height by raising and lowering the pallet as its weight changes
- Equipped with forklift pockets for easy relocation
- Rotating top minimizes worker movement
- Ergonomic design helps prevent workplace injuries
- Easy to assemble
- Platform Dim.: 43-5/8" L x 43-5/8" W
- Base Frame Dim.: 45-1/4" L x 36-3/4" W
- Capacity: 4400 lbs.
- Raised Height: 27.75"
- Lowered Height: 9.5"
- Frame Material: Steel

Model No. MO787  
Price/Each \$2699.00



## EZ X LOADER SELF-LEVELLING PALLET POSITIONER

- Economical alternative to the standard EZ Loader
- Self-leveling design keeps top of the load at convenient working height
- Pressure relief valve prevents excess pressure build-up
- Rotating top minimizes walking or reaching during the loading process
- Rollers entrapped in base frame and platform for added stability
- Captive air operation eliminates mechanical springs
- Platform Dimensions: 43" L x 43" W
- Capacity: 4000 lbs.
- Raised Height: 29.8"
- Lowered Height: 9.8"
- Lift Vertical Travel: 20"



Model No.	Mfg. No.	Frame Material	Wt. lbs.	Price /Each
LV439	EZ X LOADER	Steel	500	6225.00

## CAROUSEL PALLET TURNTABLES

- Loading and unloading operations that originally required a large amount of time can be done more efficiently with less fatigue and risk of back injury
- This Lazy Susan concept is constructed from two pieces of rolled structural angle
- A series of roller bearings transfer the load smoothly and evenly to the supporting surface
- Overall Height: 2 1/4"



Model No.	Outside Diameter"	Capacity lbs.	Wt. lbs.	Price /Each
MH204	40	2000	43	715.00
MH205	40	4000	47	785.00
MH206	40	6000	47	799.00
MH207	48	2000	51	825.00
MH208	48	4000	57	955.00
MH209	48	6000	69	1099.00



# PALLET LIFTERS

## NARROW MAST POWERED LIFT STACKERS

- Powered lift can raise and lower loads quickly and easily
- Narrow mast design provides improved manoeuvrability and efficiency
- Uses 12V battery, with integral battery charger and battery level gauge
- Equipped with support legs
- Operation Type: Electric



LV585



Model No.	Mfg. No.	Height		Lifting Capacity lbs.		Price /Each
		Raised"	Lowered"	@ 63"	@ 118"	
<b>ADJUSTABLE FORKS</b>						
LV585	SLNM-118-AA	118	2	1500	1000	8259.00
LV587	SLNM15-63-AA	63	2	1500	-	7015.00
<b>FIXED FORKS</b>						
LV586	SLNM-118-FF	118	3.25	1500	1000	7809.00
LV588	SLNM15-63-FF	63	3.25	1500	-	6639.00

## SEMI-ELECTRIC FORK LIFT STACKERS

- Powered lift can raise and lower loads quickly and easily
- Manual push stackers are easily manoeuvrable using pull handle
- Uses 12V, 130-140A battery, with integral battery charger and battery level gauge
- Equipped with support legs



LV582



Model No.	Mfg. No.	Height		Lifting Capacity lbs.			Price /Each
		Raised"	Lowered"	@ 63"	@ 118"	@ 150"	
<b>ADJUSTABLE FORKS</b>							
LV582	SL-150-AA	150	2.125	2000	1500	1000	11155.00
LV583	SL-63-AA	63	2.125	2000	-	-	8349.00
<b>FIXED FORKS</b>							
LV580	SL-118-FF	118	3.375	2000	1500	-	9399.00
LV584	SL-63-FF	63	3.375	2000	-	-	7515.00

## ELECTRIC FORK LIFT STACKERS

- Economical DC-powered lift stacker ideal for maintenance and commercial application
- Compact design and strong steel profile construction
- Can be used as manual hand pump lift for when power is not available
- Powered with two 12V, 40A batteries
- Includes battery charger and battery level gauge
- Equipped with fixed 6" wide forks, suitable for skids only
- Maximum rated lifting capacity is based on maximum height of 63"
- Lifting Capacity: 2000 lbs.
- Operation Type: Electric



LV575



Model No.	Mfg No.	Raised Height"	Lowered Height"	Machine Weight lbs.	Uniform Capacity @ 63" - 118"	Price /Each
LV576	SE/HP-63	63	3.375	879	-	7955.00
LV577*	SE/HP-63-AA	63	2.125	879	-	8795.00
LV578	SE/HP-98	98	3.375	1061	1500 lbs.	9249.00
LV575	SE/HP-118	118	3.375	1104	1500 lbs.	9509.00

\*Equipped with adjustable forks and support legs

## MANUAL HAND WINCH STACKER

- Ideal for use in various workplace applications, maintenance free and easy to use
- Full height push handle for easy steering and excellent visibility through mesh guard
- Feature heavy duty mast and unique winch design for easier and safer lifting
- Two rigid and two swivel wheels with brakes for easy manoeuvring
- Equipped with adjustable forks, ideal for use with pallets and skids
- Lifting Capacity: 770 lbs.



Model No.	Mfg No.	Raised Height"	Lowered Height"	Machine Weight lbs.	Price /Each
LV616	VWS-770-AA	60	1.5	361	2069.00

## HEFTI-LIFT LOAD STACKERS

- Hefti-Lift units provide reliable, powerful lifting when moving and positioning loads
- Unit rolls smoothly on two rigid and two swivel poly-on-steel casters with foot operated brake
- Manual hydraulic foot pump yields 3/4" of platform travel per stroke
- Welded steel construction with chrome platform uprights
- Variety of attachments available upon request
- Not for use with pallets
- Operation Type: Foot Pump
- Frame Material: Steel



Model No.	Mfg No.	Platform Dim.		Raised Platform Height"	Lowered Platform Height"	Lifting Capacity lbs.	Wt. lbs.	Price /Each
		Width"	Depth"					
LV550	HYD-10	23	24	59	4-1/2	880	270	1875.00
LV553*	HYD-10-EP	23	40	59	4-1/2	300	283	1999.00
LV554	HYD-15	23	31-1/2	63	4	1500	420	2295.00
LV555	HYD-3	23	24	35	3-1/2	880	190	1519.00
LV556	HYD-5	23	24	44	4-1/2	880	308	1569.00
LV557*	HYD-5-EP	23	40	44	4-1/2	400	283	1955.00

\* Extended Fork Length



## HYDRAULIC PLATFORM LIFT STACKER

- Allow workers to manoeuver and lift heavy loads safely to comfortable needed height
- Foot pedal folds safely out of the way
- Front 3" polyurethane wheels and rear 5" polyurethane casters



**KLETON**

### SPECIFICATIONS:

**Capacity:** ..... 880 lbs.  
**Overall Dimensions:** ..... 23" W x 39" D x 67-3/4" H  
**Platform Dimensions:** ..... 23" W x 25-3/4" D  
**Lowered Platform Height:** ..... 4"  
**Raised Platform Height:** ..... 60"  
**Weight:** ..... 174 lbs.  
**Model No. MN397**  
**Price/Each \$1699.00**

## HYDRAULIC PLATFORM LIFT STACKER

- Allows workers to manoeuver and lift heavy loads safely to comfortable needed height
- Front 5" and rear 4" phenolic casters allow loads to be moved easily
- Stacker comes standard with floor locks, safety screen and foot guards for safety

**WESCO**



### SPECIFICATIONS:

**Capacity:** ..... 1000 lbs. at 15" load center  
**Overall Dimensions:** ..... 25.5" W x 40" D x 80" H  
**Platform Size:** ..... 24" x 24"  
**Lowered Platform Height:** ..... 5 3/4"  
**Raised Platform Height:** ..... 68"  
**Base Legs:** ..... 15" inner, 21" outer  
**Wheels:** ..... 5" front, 4" rear  
**Weight:** ..... 234 lbs.  
**Model No. MH690**  
**Price/Each \$4659.00**

## PLATFORM LIFT STACKERS

### HAND WINCH

- Ideal for office use and narrow aisles
- Lightweight and sturdy design
- Manual winch lift
- Includes (2) 5" x 1.25" and (2) 2.75" x 1.25" hard rubber casters

**LU510**

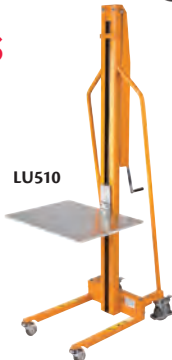

**WESCO**

Model No.	Mfg. No.	Platform Height Raised"	Platform Height Lowered"	Platform Dimensions W" x D"	Lifting Cap. lbs.	Price /Each
LU510	272467	66	5	18 x 23	220	2309.00

## HYDRAULIC FORK LIFT STACKER

- Adjustable 4" wide x 25.5" long forks
- Adjustable fork width 8.5" to 19.5"
- Two 5" polyurethane swivel casters with brake and two 3" polyurethane rigid load wheels
- Chrome plated rails and handle
- Lifting Capacity: 880 lbs.
- Operation Type: Foot Pump
- Shipped knocked down

**WESCO**



Model No.	Mfg. No.	Height Raised"	Height Lowered"	Price /Each
LU511	272941	59	3.5	2229.00
LU549	272940	47	3.5	2259.00



## PLATFORM LIFT STACKERS

- Lift and transport loads at ease
- The platform lifts approximately 1" per winch rotation or foot pump stroke
- Rolls smoothly on 6" x 2" poly-on-poly rear wheels with 2" semi-steel front wheels
- **LV481:** Rolls smoothly on 8" x 2" poly-on-poly rear wheels, four swivel casters, and a hand operated floor lock

**LU507**



**LV480**



**Vestil**

Model No.	Mfg. No.	Operation Type	Platform Height Lowered"	Platform Height Raised"	Platform Dimensions W" x D"	Lifting Cap. lbs.	Price /Each
<b>STEEL</b>							
LU506	LLW-202058-FW	Hand Winch	3-1/8	58	20 x 20	500	1409.00
LU507	LLH-202053-FW	Foot Pump	3-1/8	51-1/8	20 x 20	500	1689.00
<b>ALUMINUM</b>							
LV480	ALLW-2020-FW	Hand Winch	3-1/8	58	20 x 20	400	1249.00
LV481	ALLW-2420-4SFL	Hand Winch	6-1/8	60	24 x 20	400	1849.00

## FORK LIFT STACKERS

- Compact lift trucks are designed to lift material to and from shelves
- Constructed of durable steel-and-aluminum
- The rugged 4" wide by 1.1" thick steel forks measure 22" long (20" O.D.)
- Hand-crank winch features a reversible handle and a hold-down device for securing the carriage during transport
- Operation Type: Hand Winch
- Two 8" non-marking rear wheels, two 2" front swivel casters
- **LU503-LU505:** Counter balanced design has poly-on-poly wheels, (2) 5" rear wheels, (2) 4" front wheels.

**LU498**



**LU500**



**LU503**



**Vestil**

Model No.	Mfg. No.	Height Raised"	Height Lowered"	Height w/Forks Up Raised"	Height Lowered"	Overall Dimensions L" x W" x H"	Lifting Cap. lbs.	Price /Each
<b>STANDARD</b>								
LU498	A-LIFT-R	47	3.5	67	23.5	24 x 35 x 68-3/4	500	2195.00
LU499	A-LIFT-R-HP	97	3.5	117	23.5	24 x 35 x 67-5/16	400	2585.00
<b>STRADDLE</b>								
LU500	A-LIFT-S	47	1.25	68	21.25	43-7/8 x 42-1/2 x 67-5/16	500	2375.00
LU501	A-LIFT-S-HP	98	1.25	120	21.25	43-1/4 x 42-1/2 x 67-5/16	400	2599.00
LU502	A-LIFT-S-EHP	122	1.25	143	21.25	43-7/8 x 42-1/2 x 79-1/8	350	2519.00
<b>COUNTERBALANCE</b>								
LU503	A-LIFT-CB	47	2	68	21.25	43-1/4 x 45-7/8 x 67-15/16	500	2799.00
LU504	A-LIFT-CB-HP	98	2	120	21.25	43-1/4 x 45-7/8 x 67-15/16	400	2975.00
LU505	A-LIFT-CB-EHP	122	2	143	21.25	43-1/4 x 46 x 79-1/8	350	3385.00

# LIFTING EQUIPMENT

F.O.B. VAUDREUIL, QC. ITEMS ON THIS PAGE ARE MADE TO ORDER AND ARE NON-RETURNABLE

## ADJUSTABLE GANTRY CRANES

- Adjustable gantry cranes move and lift heavy equipment with ease
- Height adjustable between 8' and 14'
- Equipped with four heavy-duty steel swivel casters with wheel brakes
- H-Beams use flat-wheel trolleys; I-Beams use taper-wheel trolleys.
- Can be fitted with or without casters
- Shipped knocked down

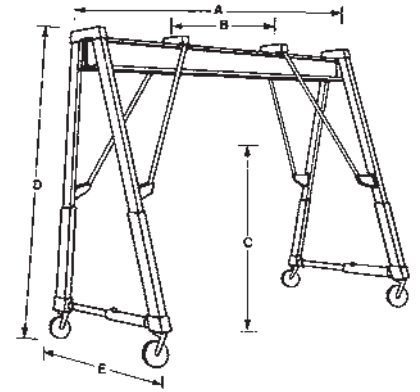

**MuscleMate**



Model No.	Lifting Cap. lbs.	O.A. Span A'	Clear Span B	Hook Lift Min/Max C	O.A. Height Min/Max D	Beam Height E"	Wheel Spread Min/Max F	Unit Beam Width"	Wt. lbs.	Price /Each
LA189	2000	10	47"	6'8"/11'6"	8'9"/14'7"	6	4'7"/7"	3 3/8	885	10089.00
LA190	2000	15	97"	6'6"/11'10"	8'9"/14'7"	8	4'7"/7"	5 1/4	1050	11999.00
LA191	4000	10	47"	6'2"/11'10"	8'9"/14'7"	8	4'7"/7"	4	1175	12325.00
LA192	4000	15	97"	6'/11'8"	8'9"/14'7"	10	4'7"/7"	5 3/4	1370	14589.00
LA193	6000	10	47"	5'/11'1"	8'9"/14'9"	10	4'10"/7'3"	4 5/8	1430	14695.00
LA194	6000	15	97"	5'/11'1"	8'9"/14'9"	10	4'10"/7'3"	5 3/4	1615	17049.00

Note: Crane only, hoist and trolley not included.

## PORTABLE FLOOR CRANES

- Lifts, lowers, positions and moves up to 2000 lbs. with ease
- Hand operated hydraulic pump lifts fully extended boom over 8'
- Crane moves easily with smooth rolling casters
- Fully collapsible, knocks down in seconds for easy storage
- Each crane supplied with 30" adjustable chain and hook
- Shipped knocked down

Folded for Storage



**MuscleMate**

Model No.	Cap. lbs.	Overall Height"	Overall Length"	Overall Width"	Caster Type	Wt. lbs.	Price /Each
LA572	1000	69.25	63.5	31	Phenolic	260	4499.00
LA567	2000	69.25	63.5	37	Cast Iron	275	4729.00
LA838			Replacement Hydraulic Pump				759.00

Model No.	Boom Reach"/Capacity lbs.			
	1st position	2nd position	3rd position	4th position
LA572	56.5/1000	63.5/770	70.5/320	N/A
LA567	52.5/2000	62.5/1280	72.5/520	82.5/380



## FOLDING ENGINE CRANE

- 4-position boom extends for hard-to-reach applications
- 4 large swivel castors provide easier positioning
- Fold-up legs reduce storage space required when not in use
- Capacity: 4000 lbs. (2 tons)
- Capacity: 38-1/2" – 59-1/2"

Model No. UAV834  
Mfg. No. 024858  
Price/Each \$619.00



## LIFT MATE WORKSTATION GANTRIES

- Equip your assembly area with an effective working concept
- Equipped with steel floor pads, pre-drilled for anchoring to floor
- To customize unit, additional options include chain blocks, festoon kit, trolley, 10' L beam for cantilever operation
- Adjustable height
- Heavy capacities and "A" frame styles are available upon request
- Capacity: 2000 lbs.
- Shipped knocked down

Model No. LT481 Capacity: 1000 lbs.  
Price/Each \$7265.00

Model No. LT482 Capacity: 2000 lbs.  
Price/Each \$8039.00

**MuscleMate**





F.O.B. VAUDREUIL, QC. ITEMS ON THIS PAGE ARE MADE TO ORDER AND ARE NON-RETURNABLE

## SPREADER BEAM

- Comes standard with lifting shackles
- Custom lengths and capacities available

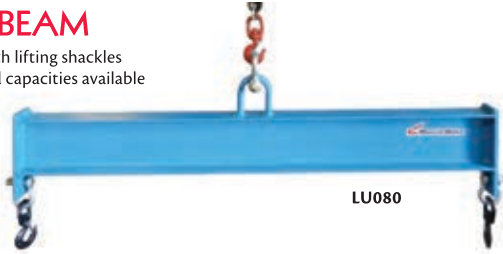

LU096

## MuscleMate

Model No.	Capacity	Spreader Type	Dimensions to Hook'	Price /Each
LU080	1000 lbs (0.5 tons)	Fixed	4	1749.00
LU081	1000 lbs (0.5 tons)	Fixed	6	1989.00
LU082	1000 lbs (0.5 tons)	Fixed	8	2249.00
LU083	1000 lbs (0.5 tons)	Fixed	10	2859.00
LU084	2000 lbs (1 ton)	Fixed	4	1789.00
LU085	2000 lbs (1 ton)	Fixed	6	2019.00
LU086	2000 lbs (1 ton)	Fixed	8	2305.00
LU087	2000 lbs (1 ton)	Fixed	10	3019.00
LU088	4000 lbs. (2 tons)	Fixed	4	1989.00
LU089	4000 lbs. (2 tons)	Fixed	6	2125.00
LU090	4000 lbs (2 tons)	Fixed	8	2505.00
LU091	4000 lbs (2 tons)	Fixed	10	3375.00
LU092	10 000 lbs. (5 tons)	Fixed	4	2809.00
LU093	10 000 lbs. (5 tons)	Fixed	6	3109.00
LU094	10 000 lbs. (5 tons)	Fixed	8	4075.00
LU095	10 000 lbs. (5 tons)	Fixed	10	4769.00

Model No.	Capacity	Spreader Type	Hook to Hook Min' - Max'	Price /Each
LU096	1000 lbs (0.5 tons)	Adjustable	3.5 - 6	1595.00
LU097	1000 lbs (0.5 tons)	Adjustable	4 - 8	1789.00
LU098	1000 lbs (0.5 tons)	Adjustable	5 - 10	2575.00
LU099	1000 lbs (0.5 tons)	Adjustable	6 - 12	2915.00
LU101	2000 lbs (1 ton)	Adjustable	4 - 8	2485.00
LU102	2000 lbs (1 ton)	Adjustable	5 - 10	2859.00
LU103	2000 lbs (1 ton)	Adjustable	6 - 12	3249.00
LU104	4000 lbs. (2 tons)	Adjustable	4 - 6	2485.00
LU105	4000 lbs. (2 tons)	Adjustable	4 - 8	2859.00
LU106	4000 lbs. (2 tons)	Adjustable	5 - 10	3305.00
LU107	4000 lbs (2 tons)	Adjustable	6 - 12	3679.00
LU108	10 000 lbs. (5 tons)	Adjustable	4 - 8	3605.00
LU109	10 000 lbs. (5 tons)	Adjustable	5 - 10	4465.00
LU110	10 000 lbs. (5 tons)	Adjustable	6 - 12	5059.00

## FLOOR CRANES

## MuscleMate

## MuscleMate

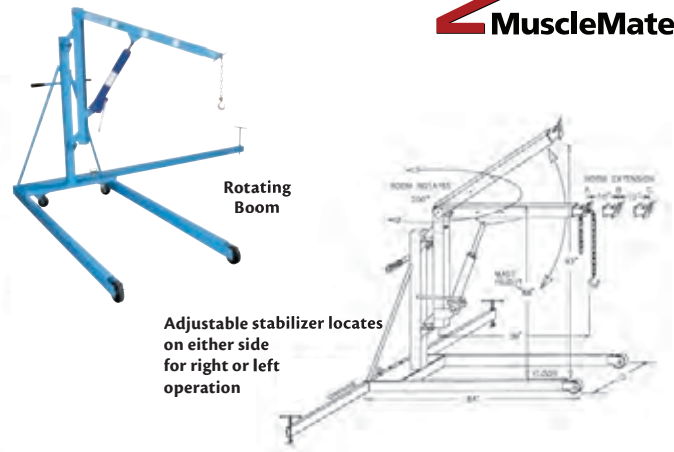
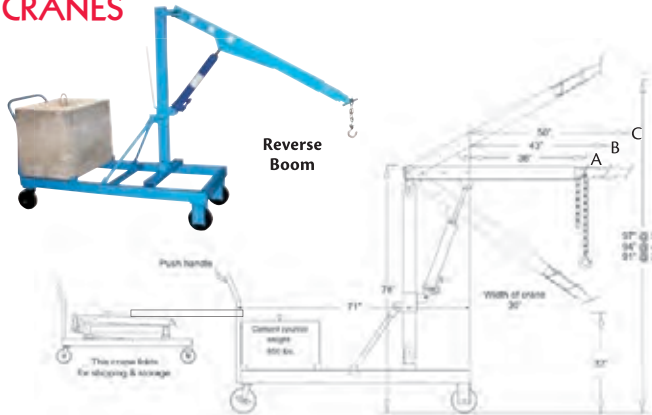

### REVERSE BOOM

- Counter weight design allows you to place the crane close to the item being lifted without obstruction by the legs on regular floor crane models
- Reaches over machinery or loading docks easily
- Useful for supplying materials to production areas that are not serviced by overhead cranes
- Equipped with roller bearing wheels, swivel wheel foot brakes, manual pump, adjustable chain and hook, safety pins, push handle and counterweight

### ROTATING BOOM

- Move your load to either side quickly and safely
- Adjustable outrigger provides stability for side loading
- Allows you to swing the boom 200° to either side while holding a full load
- Useful in tight work spaces where the crane itself cannot be turned

**Note:** Outrigger extends to one side at a time. Do not swing the boom to the opposite side of the outrigger. This crane is equipped with heavy-duty roller bearing wheels, manual pump, adjustable chain and hook, safety pins and guide handle.

Model No.	Boom Capacity lbs.			Counterweight lbs.	Width"	Wt. lbs.	Price /Each
	A	B	C				
LA793*	1000	770	650	650	30	1050	9819.00
LA794*	2000	1280	1000	1300	30	1750	12495.00
LA795	3000	2000	1500	1950	30	2450	16449.00
LA838	Replacement Hydraulic Pump for LA793 and LA794						759.00

Model No.	Boom Capacity lbs.			Wheel Dia." Front	Wheel Dia." Rear	Wt. lbs.	Price /Each	
	A	B	C					
LA796	1000	770	320	36	5	4	450	7869.00
LA797	2000	1280	520	36	5	4	550	11495.00
LA798	3000	1500	800	40	8	6	690	14695.00
LA838	Replacement Hydraulic Pump for LA796 and LA797						759.00	

### DIMENSIONS

Boom Reach"			Lift Clearance"	
A	B	C	Min.	Max.
36	43	50	32	91 @ 36 - 94 @ 43 - 97 @ 50

### DIMENSIONS

Boom Reach"			Lift Clearance"	
A	B	C	Min.	Max.
59	69	79	68	92

\*Shipped knocked down

# LIFTING EQUIPMENT

F.O.B. VAUDREUIL, QC. ITEMS ON THIS PAGE ARE MADE TO ORDER AND ARE NON-RETURNABLE

## WALL JIBS

### STYLE 100 & 200

- Mount at any height on a wall, column or building support
- Wall mounting gives 180° rotation, column mounting provides 220° of rotation
- Equipped with end stops to limit trolley travel
- **H-Beams** use flat-wheel trolleys; **I-Beams** use taper-wheel trolleys

### STYLE 100

Cantilever design is ideally suited for mounting applications where headroom is limited.

### STYLE 200

Easily adjustable tie rod jibs are designed to mount within inches of any overhead obstruction.

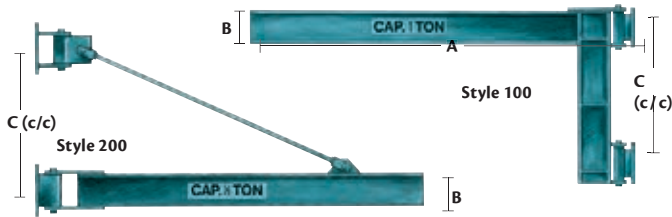

Model No.	Cap. lbs.	A'	Dimensions B"	C"	Flange Width"	Beam Type	Wt. lbs.	Price /Each
<b>STYLE 100</b>								
LA221	1000	8	6	32	3	I	192	3609.00
LA219	1000	10	8	36	4	I	300	4395.00
LA220	1000	12	8 1/8	45	5 1/4	H	295	4945.00
LA224	2000	8	8	32	4	I	265	4285.00
LA222	2000	10	10	36	4 5/8	I	390	5075.00
LA223	2000	12	10 3/8	45	5 3/4	H	435	5805.00
LA779	4000	8	12	36	5	I	450	7529.00
LA780	4000	10	12	48	5	I	550	8579.00
LA781	4000	12	12	60	5	I	650	11089.00
<b>STYLE 200</b>								
LA227	1000	8	6	32	3 3/8	I	163	2449.00
LA225	1000	10	6	36	3 3/8	I	190	2735.00
LA226	1000	12	6	45	3 3/8	I	233	3019.00
LA782	1000	14	8 1/8	54	5 1/4	H	340	3679.00
LA783	1000	16	8 1/8	66	5 1/4	H	375	4089.00
LA230	2000	8	6	32	3 3/8	I	180	2645.00
LA228	2000	10	6	36	3 3/8	I	220	3055.00
LA229	2000	12	6	45	3 3/8	I	243	3485.00
LA784	2000	14	8 1/8	54	5 1/4	H	350	4089.00
LA785	2000	16	8 1/8	66	5 1/4	H	385	4965.00
LA786	4000	8	10	36	4 5/8	I	395	4539.00
LA787	4000	10	10	38	4 5/8	I	445	5255.00
LA788	4000	12	10	51	4 5/8	I	495	5879.00
LA789	4000	14	10 3/8	58	5 3/4	H	545	6945.00
LA790	4000	16	10 3/8	68	5 3/4	H	595	7799.00

## PALLET LIFTERS

- Ideal for use with crane systems or with truck cranes
- Economical pallet lifters are available in four capacities with three adjustable or non-adjustable fork lengths to choose from

A - Throat height (clear) 48"  
B - Fork length 36", 42", or 48"  
C - Widths (O.D.) 27"

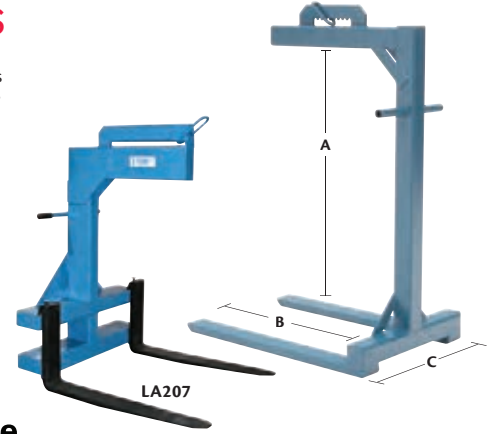

Cap. lbs.	Fork Length"	Standard Model No.	Wt. lbs.	Price /Each	Adj. Model No.	Wt. lbs.	Price /Each
1000	36	LA195	190	3309.00	LA207	270	6319.00
	42	LA196	230	3799.00	LA208	295	6625.00
	48	LA197	255	4075.00	LA209	325	6965.00
2000	36	LA198	195	3969.00	LA210	280	6735.00
	42	LA199	233	4255.00	LA211	305	7125.00
	48	LA200	260	4539.00	LA212	335	7499.00
4000	36	LA201	310	5469.00	LA213	380	8555.00
	42	LA202	337	5699.00	LA214	430	9015.00
	48	LA203	370	6069.00	LA215	475	9465.00
6000	36	LA204	522	6699.00	LA216	525	9909.00
	42	LA205	560	7479.00	LA217	560	10255.00
	48	LA206	602	8415.00	LA218	612	10945.00

## ADJUSTABLE PALLET LIFTERS

- Ideal for use with crane systems or with truck cranes
- Economical pallet lifters are available in four capacities with three adjustable or non-adjustable fork lengths to choose from

A - Throat height (clear): 48"  
B - Fork Length: 36", 42", or 48"  
C - Width: (O.D.) 27"



Model No.	Cap. lbs.	Fork Length"	Wt. lbs.	Price /Each
LA475	1000	36	190	3395.00
LA476	1000	42	230	3895.00
LA477	1000	48	270	4165.00
LA478	2000	36	195	4025.00
LA479	2000	42	235	4625.00
LA480	2000	48	260	4965.00

## JIB BOOMS

- Instantly converts fork lift trucks into mobile jib cranes for an infinite variety of uses
- Fully adjustable booms reach out, pick-up, and move heavy long loads making your fork lift more versatile
- Boom slips onto the forks and anchors to the truck with a safety chain
- Includes two adjustable hooks



Model No.	Boom Type	Min. Fork Lift Cap. lbs.		Max. Boom Cap. lbs. (Reach ft.)					Wt. lbs.	Price /Each
		0-7	8	9	10	11	12			
LA188	Fixed	3000	1000	800	725	650	600	500	255	3605.00
LA187	Elevating	3000							285	4465.00
LA186	Fixed	8000	3000	2700	2400	2200	2000	1900	438	4805.00
LA185	Elevating	8000							483	6305.00

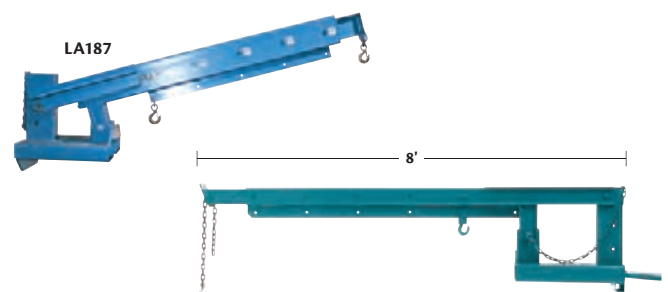

# LIFTING EQUIPMENT

## DYNAMIC LIFT™ MAGNETS

- Lifting Capacity: 150 lbs.
- Weight: 6.1 lbs.
- Powerful rare earth permanent lift magnets
- Top rotating locking On/Off handle
- Lifts flat or round loads horizontally
- Lifts flat loads vertically
- Heat resistant up to 180° F (82° C)
- 3:1 Design factor
- **Conforms to ASME B30.20 standards**



LU436



Model No.	Overall Dimensions				Lift lb	Wt. lb	Price /Each
	L" x W" x H"	L" x W" x H"	L" x W" x H"	L" x W" x H"			
LU436	5 x 2 x 9				150	6.1	593.00
LU437	6 1/2 x 4 x 9 1/4				334	13.3	1346.00

## CREATIVE LIFT® MAGNETS

- Permanent lift magnets are ideal for handling steel plates, die castings, forgings etc.
- They eliminate the need for clamping devices, slings or chains
- One person can perform operations previously calling for two or more people
- Non-marring roller cam release
- Durable stainless steel casing
- 3:1 design factor
- **Conforms to ASME B30.20 standards.**



Model No.	Dimensions			Magnet		Holding Capacity lbs.	Price /Each
	L" x W" x H"	L" x W" x H"	L" x W" x H"	H" L"			
LS708	7 3/4 x 7 1/4 x 6 3/4			2 1/2	4	400	828.00
LS709	10 3/4 x 7 1/4 x 6 3/4			2 1/2	7	1000	929.00
LS710	14 3/4 x 7 1/4 x 6 3/4			2 1/2	10 1/2	1500	1215.00
LT271	15 x 10 1/2 x 7			2 1/2	11 1/4	2200	2101.00
LS711	19 1/4 x 10 1/2 x 7			2 1/2	15 1/4	3000	2403.00

### HOLDING VALUE & MAX. SHEET LENGTH (IN FEET) FOR SPECIFIED MATERIAL THICKNESS

Model No.	3/16"		1/4"		1/2"		1"		2"	
	Cap. lbs.	Length	Cap. lbs.	Length	Cap. lbs.	Length	Cap. lbs.	Length	Cap. lbs.	Length
LS708	400	6	400	6	400	8	400	10	400	10
LS709	600	6	900	6	1000	8	1000	10	1000	10
LS710	800	6	1000	6	1500	8	1500	10	1500	10
LT271	800	6	1064	6	2000	8	2200	10	2200	10
LS711	800	6	1100	6	2700	8	3000	10	3000	10

## WINCH OPERATED TRUCK JIB CRANE

- Lift items from ground to truck bed height
- Install in pick up truck beds
- Telescopic boom design with manual hydraulic hand pump to pivot boom up and down
- Manual cable winch to lift and lower loads
- Friction brake winch locks automatically when operator turns the handle counter clockwise to lower load
- Unit comes with one fixed hook, one chain slot lock, and one cable hook with latch



Model No.	Boom Extended Capacity lbs.	Boom Retracted Capacity lbs.	Cable Winch Capacity lbs.	Boom Extended Reach"	Boom Retracted Reach"	Extended Lift Range"	Retracted Lift Range"	Finish	Cable Usage Length	Price /Each
LU494	500	1000	500	51	34-3/4	0-102	10-89-1/2	Yellow Coated	9'	955.00
LU495	1000	2000	500	44	30	0-86-1/2	13-1/2-77-1/2	Yellow Coated	9'	1035.00
LU496	500	1000	500	52	30-1/2	0-99	13-1/2-84	Galvanized	20' w/Dia. 1/4"	1425.00
LU497	1000	2000	500	52	31	0-97	13-1/2-86	Galvanized	20' w/Dia. 1/4"	1665.00

## GX LIFTING CLAMPS

- Entirely drop forged and heat treated
- Strong, yet lightweight
- Ideal for both vertical and horizontal-to-vertical lifting
- Feature a patented wear indicator system
- 100% proof tested

### Campbell®

Model No.	Capacity Ton	Grip Range"	Wt. lbs.	Price /Each
LB606	1/2	1/16-5/8	4	570.30
LB607	1	1/16-3/4	8	810.00
LB608	3	1/16-1	17	1551.50



## BEAM CLAMP

- Caution: Never exceed work load limit



VANGUARD STEEL LTD.

Model No.	Capacity	Jaw Opening"	Price /Each
LU561	2000 lbs. (1 ton)	0-10-1/4	117.00
LU562	4000 lbs. (2 tons)	0-10-1/4	132.00
LU563	6000 lbs. (3 tons)	0-13-15/16	236.00
LU564	10 000 lbs. (5 tons)	0-13-15/16	268.00
LU565	20 000 lbs. (10 tons)	0-14-3/8	404.00



## POWERLIFT® MAGNETS

- Compact yet powerful rare earth lift magnets can be used on flat or round surfaces and contain an internal release on/off device that does not contact or damage the surface of the part being lifted
- Permanent magnetic lifts eliminate the fear of dropping the load being lifted due to power failures
- 3:1 design factor
- **Conforms to ASME B30.20 standards**



Model No.	Capacity lbs.		Minimum Diameter"	Dimensions			Handle"	Wt. lbs.	Price /Each
	Flat	Round		L" x W" x H"	L" x W" x H"	L" x W" x H"			
LS712	250	125	2	5 x 2 5/8 x 6 5/8	5 7/8	7	411.00		
LS713	800	400	3	7 7/8 x 3 5/8 x 8 7/8	6 7/8	22	961.00		
LS714	1600	800	4	10 3/4 x 4 7/8 x 8 7/8	6 3/4	53	1622.00		
LS715	2500	1250	5	12 5/8 x 7 1/8 x 8 7/8	10 1/8	110	3072.00		

### HOLDING VALUE & MAX. SHEET LENGTH (IN FEET) FOR SPECIFIED MATERIAL THICKNESS

Model No.	1/4"		1/2"		3/4"		1"		3"	
	Cap. lbs.	Length	Cap. lbs.	Length	Cap. lbs.	Length	Cap. lbs.	Length	Cap. lbs.	Length
LS712	180	6	250	6	250	6	250	10	250	10
LS713	270	6	615	6	800	6	800	10	800	10
LS714	N/A	-	800	6	1600	6	1600	10	1600	10
LS715	N/A	-	N/A	-	N/A	-	1300	10	2500	10

## BASICLIFT MAGNETS

- Permanent lift magnet for a broad range of lifting applications
- Full width cam release
- Large lift lug
- Light weight design
- Durable stainless steel casing
- Heat resistant up to 300°F (148°C)
- 2:1 design factor



Model No.	Overall Dimensions			Lift lb	Wt. lb	Price /Each
	L" x W" x H"	L" x W" x H"	L" x W" x H"			
LT372	7 1/2 x 5 5/8 x 5 1/2			400	13	615.00
LT373	11 x 5 5/8 x 5 1/2			1000	18	866.00
LT374	14 1/2 x 5 5/8 x 5 1/2			1500	28	1171.00

### HOLDING VALUE & MAX. SHEET LENGTH (IN FEET) FOR SPECIFIED MATERIAL THICKNESS

Model No.	3/16"		1/4"		1/2"		3/4"		1"	
	Cap. lbs.	Length	Cap. lbs.	Length	Cap. lbs.	Length	Cap. lbs.	Length	Cap. lbs.	Length
LT372	375	6	400	6	400	8	400	8	400	10
LT373	725	6	800	6	975	8	1000	8	1000	10
LT374	875	6	1000	6	1400	8	1500	8	1500	10



# LIFTING EQUIPMENT

## LEVER HOISTS

- Lightweight steel construction
- Short steel handle rotates 360° to allow operation in any position
- Load brake assures safety and load control
- High tensile alloy steel load chain for increased strength and durability
- Latched swivel hooks for added security
- Enclosed chain guide ensures dirt and dust do not affect operation
- Meets ASME B30.16

KLETON

Model No.	Lift'	Cap lbs.	Wt. lbs.	Price/Each
LW562	5	1500	15	262.00
LW563	5	2000	18	325.00
LW564	5	3000	24	359.00
LW565	5	6000	42	565.00
LS550	5	12 000	62	795.00



## CHAIN HOISTS

- Lightweight steel construction
- Triple spur geared for easy lifting
- Load brake assures safety and load control
- High tensile alloy steel load chain for increased strength and durability
- Latched swivel hooks for added security
- Enclosed chain guide ensures dirt and dust do not affect operation
- Meets ASME B30.16

KLETON

Model No.	Lift'	Cap lbs.	Wt. lbs.	Price/Each
LS534	10	1000	24	195.00
LS535	10	2000	29	219.00
LW569	10	3000	44	275.00
LW570	10	4000	48	315.00
LS538	10	6000	59	345.00
LS539	10	10 000	100	485.00
LW573	20	1000	36	245.00
LS541	20	2000	40	285.00
LW575	20	3000	59	345.00
LW576	20	4000	62	395.00
LS544	20	6000	84	525.00
LS545	20	10 000	136	685.00



## ADJUSTABLE TROLLEYS

- Easily adjusts to fit various flanges, I-beams and H-beams
- Use on straight or curved track
- Can be installed or removed at any position on the beam
- Heavy-duty cast iron wheels
- Deep width flange provides superior contact with the beam
- Geared trolleys include two geared wheels operated by hand chain
- Safety plate included
- Meets ASME B30.16

KLETON

Model No.	Fits I beams"	Cap. lbs.	Wt. lbs.	Price /Each
<b>PLAIN</b>				
LS551	2 11/16 - 5 3/8	1000	10	129.00
LS552	3 1/8 - 6 1/4	2000	17	165.00
LW554	3 1/8 - 6 1/4	4000	28	255.00
LS554	3 7/16 - 7 3/8	6000	46	425.00
LS555	4 13/16 - 9 9/16	10 000	73	635.00
<b>GEARED</b>				
LS556	2 11/16 - 5 1/4	1000	18	255.00
LW558	3 1/8 - 5 15/16	2000	25	299.00
LS558	3 1/8 - 7 1/16	4000	36	425.00
LW560	3 7/16 - 7 3/8	6000	54	535.00
LS560	4 3/4 - 7 3/4	10 000	81	795.00

Adjustable Plain Trolley



Adjustable Geared Trolley

## KCH SERIES HEAVY-DUTY CHAIN HOIST

- Professional grade triple spur gear is lightweight and portable
- Dual pawl Weston-style brake provides safe and reliable operation
- Made with premium grade non-asbestos brake discs for long service life
- Maintenance-free sealed bearings provide easy operation
- Load tested to 150% of rated capacity and includes certificate
- Heavy-duty ratchet gear protects brake disc from contamination
- Made with premium grade 100 heat-treated alloy steel load chain
- Top and bottom safety hooks are engineered to bend lowly in case of accidental overload
- Made with a high-visibility safety orange finish
- Chain Material: Heat-Treated Alloy Steel
- Standard(s) Met: ISO 9001-2000, ASME B30.16
- Load Chain Grade: 100
- Number of Falls: 1
- Number of Safety Hooks: 2



Model No.	Mfg. No.	Capacity lbs. (tons)	Lift'	Head Room"	Load Chain Diameter	Min. Distance Between Hooks"	Force Required to Lift lbs.	Price /Each
UAV851	101102	1100 (0.5)	10	11-1/4	5 mm	11-1/4	51	335.00
UAV852	101106	1100 (0.5)	20	11-1/4	5 mm	11-1/4	51	465.00
UAV853	101112	2200 (1)	10	11-5/8	6.3 mm	11-5/8	64	399.00
UAV854	101136	4400 (2)	20	14-3/4	8 mm	14-3/4	79	825.00

## KCH SERIES HEAVY-DUTY CHAIN HOIST WITH OVERLOAD PROTECTION

- Equipped with an automatic overload protection device as standard equipment (up to 5 tons)
- Device is factory preset to prevent serious overload of the hoist
- Actuation is automatic, requiring no input from the operator
- Triple spur geared for efficient operation
- Grade 100 load chain for greater strength
- Exclusive premium grade, non-asbestos brake discs for longest life
- Load tested to 150% of rated capacity with certificate
- Standard(s) Met: ISO 9001-2000, ASME B30.16
- Load Chain Grade: 100
- Number of Falls: 2



Model No.	Mfg. No.	Capacity lbs. (tons)	Lift'	Head Room"	Load Chain Diameter	Force Required to Lift lbs.	Price /Each
UAV855	101356	11000 (5)	20	23-5/8	9 mm	83	1875.00

## VCH SERIES CHAIN HOIST

- Professional grade triple spur gear is lightweight and portable
- Dual pawl Weston-style brake provides safe and reliable operation
- Made with premium grade non-asbestos brake discs for long service life
- Made with grade 80 heat-treated alloy steel load chain
- Load tested to 150% of rated capacity and includes certificate
- Top and bottom safety hooks are engineered to bend lowly in case of accidental overload
- Made with a high-visibility safety orange finish
- Chain Material: Heat-Treated Alloy Steel
- Standard(s) Met: ISO 9001-2000, ASME B30.16
- Load Chain Grade: 80
- Number of Safety Hooks: 2



Model No.	Mfg. No.	Capacity lbs. (tons)	Lift'	Head Room"	Load Chain Diameter	Number of Falls	Min. Distance Between Hooks"	Force Required to Lift lbs.	Price /Each
UAV846	101006	1100 (0.5)	20	11-1/32	6 mm	1	11-1/32	49	355.00
UAV847	101012	2200 (1)	10	12-1/16	6 mm	1	12-1/16	68	275.00
UAV848	101016	2200 (1)	20	12-1/16	6 mm	1	12-1/16	68	389.00
UAV849	101032	4400 (2)	10	17-1/2	8 mm	1	17-1/2	102	415.00
UAV850	101046	6600 (3)	20	20-15/32	8 mm	2	20-15/32	88	685.00

# LIFTING EQUIPMENT

## KLP SERIES LEVER CHAIN HOIST

- High impact gear case and brake cover for heavy duty service
- Caged ball bearings on load sprocket for the ultimate in smooth, easy operation
- Dual pawl Weston-style brake features extra heavy pawl springs for reliable and safe operation
- Exclusive premium grade, non-asbestos brake discs for longest life
- Top and bottom safety hooks bend to warn of overloads
- Cast steel safety latches exceed industry standards
- Deformation indicators on hooks allow accurate measurement for easy maintenance
- Load tested to 150% of rated capacity with certificate
- Standard(s) Met: ISO 9001-2000, ASME B30.21
- Load Chain Grade: 100
- Number of Falls: 1
- Force Required to Lift: 46 lbs.
- Lever Length: 16-1/4"



Model No.	Mfg. No.	Capacity lbs. (tons)	Lift'	Load Chain Diameter	Min. Distance Between Hooks"	Price /Each
UAV860	110403	3000 (1.5)	5	7.1 mm	13-3/4	489.00

## KLP SERIES HEAVY-DUTY LEVER CHAIN HOIST

- High impact gear case and brake cover for heavy duty service
- Grade 100 load chain for greater strength
- Caged ball bearings on load sprocket for the ultimate in smooth, easy operation
- Dual pawl Weston style brake features extra heavy pawl springs for reliable and safe operation
- Exclusive premium grade, non-asbestos brake discs for longest life
- Top and bottom safety hooks bend to warn of overloads
- Cast steel safety latches exceed industry standard
- Deformation indicators on hooks allow accurate measurement for easy maintenance
- Load tested to 150% of rated capacity (with certificate)
- Meets ASME B30.21 standards



Model No.	Mfg. No.	Capacity lbs. (tons)	Lift'	Load Chain Diameter	Min. Distance Between Hooks"	Price /Each
UAV892	110404	6000 (3)	5	10 mm	16-1/2	789.00
UAV893	110406	1500 (0.75)	10	5.6 mm	11	465.00

## KLP SERIES HEAVY-DUTY LEVER CHAIN HOIST WITH OVERLOAD PROTECTION

- High impact gear case and brake cover for heavy duty service
- Grade 100 load chain for greater strength
- Caged ball bearings on load sprocket for the ultimate in smooth, easy operation
- Dual pawl Weston style brake features extra heavy pawl springs for reliable and safe operation
- Exclusive premium grade, non-asbestos brake discs for longest life
- Top and bottom safety hooks bend to warn of overloads
- Cast steel safety latches exceed industry standard
- Deformation indicators on hooks allow accurate measurement for easy maintenance
- Load tested to 150% of rated capacity (with certificate)
- Meets ASME B30.21 standards
- Complete with automatic overload protection
- Overload clutch prevents application of overloads severe enough to damage puller or present a danger to workers



Model No.	Mfg. No.	Capacity lbs. (tons)	Lift'	Price /Each
UAV894	110414	6000 (3)	5	989.00

## VLP SERIES LEVER CHAIN HOIST

- Cold formed stamped steel housings resist impact
- Hardened steel roller bearings support load for easier operation
- Dual pawl Weston-style brake for reliable and safe operation
- Exclusive premium grade, non-asbestos brake discs for longest life
- Top and bottom safety hooks bend to warn of overloads
- Deformation indicators on hooks allow accurate measurement for easy maintenance
- Load tested to 150% of rated capacity with certificate
- Lift: 10'
- Standard(s) Met: ISO 9001-2000, ASME B30.21
- Load Chain Grade: 80
- Number of Falls: 1



Model No.	Mfg. No.	Capacity lbs. (tons)	Load Chain Diameter	Min. Distance Between Hooks"	Force Required to Lift lbs.	Lever Length"	Price /Each
UAV857	110306	1653.46 (0.75)	6 mm	12	31	12	369.00
UAV858	110307	3000 (1.5)	8 mm	15	48	16-1/2	489.00
UAV859	110308	6600 (3)	10 mm	18-7/8	70	16-1/2	719.00



## VLP SERIES LEVER PULLER

- Light weight design combines versatility with economy
- Load tested to 150% of rated capacity
- Meets ANSI B30.21 specifications (Certificate included)
- Special heavy-duty, long-lasting brake pads – last up to five times longer than competitive brands
- Stamped steel housing protects gears and brake mechanism from damage
- Galvanized chain, hub, lever switch and inside plates
- Completely repairable with easy access for maintenance; parts and service are readily available
- Two coats of high visibility safety orange protective coating
- Short lever length allows for easier access into confined work areas
- High quality load chain meets all international safety standards
- All hooks have safety latches as an additional safety feature and are designed to bend slowly rather than fracture under overload conditions
- Chain Material: Galvanized Steel



Model No.	Mfg. No.	Capacity lbs. (tons)	Lift'	Load Chain Diameter"	Min. Distance Between Hooks"	Price /Each
UAV895	110603	500 (0.25)	5	5.9	8.3	259.00
UAV896	110604	1000 (0.5)	5	8.5	10	309.00

## VLP SERIES HEAVY-DUTY LEVER PULLER

- High impact gear case and brake cover for heavy duty service
- Grade 100 load chain for greater strength
- Caged ball bearings on load sprocket for the ultimate in smooth, easy operation
- Dual pawl Weston style brake features extra heavy pawl springs for reliable and safe operation
- Exclusive premium grade, non-asbestos brake discs for longest life
- Top and bottom safety hooks bend to warn of overloads
- Cast steel safety latches exceed industry standards
- Deformation indicators on hooks allow accurate measurement for easy maintenance
- Load tested to 150% of rated capacity (with certificate)
- Meets ASME B30.21 standards
- Chain Material: Galvanized Steel



Model No.	Mfg. No.	Capacity lbs. (tons)	Lift'	Lever Length"	Min. Distance Between Hooks"	Price /Each
UAV897	110804	1000 (0.5)	5	6.3	9.84	395.00

## SGT SERIES HEAVY-DUTY GEARED TROLLEY

- Geared wheels driven by hand chain for precise load control
- 10' hand chain drop



Model No.	Mfg. No.	Capacity lbs. (tons)	I-Beam Flange Width"	Min. Curve Radius"	Price /Each
UAV901	120366	10000 (5)	4-1/2 - 8-1/32	55	1679.00
UAV902	120367	20000 (10)	4-15/16 - 8-1/32"	67	2249.00

## VBT SERIES MANUAL TROLLEY

- Specially designed integrated drop stops/ bumpers take the load in the event of wheel failure and prevent the wheels from contacting other trolleys on the track
- Adjustable to fit securely on a wide range of flanges and beam widths
- Can be installed or removed at any point along the track
- Use on straight or curved H and I beams



Model No.	Mfg. No.	Capacity lbs. (tons)	I-Beam Flange Width"	Min. Curve Radius"	Price /Each
UAV900	120112	2000 (1)	2-1/2 - 5-1/2	40	185.00

# LIFTING EQUIPMENT

## LODESTAR ELECTRIC CHAIN HOISTS

- Features quiet operation, an environment friendly design, easy access to components, high duty cycles, along with less maintenance and enhanced safety features
- Lifetime grease-lubricated gear box
- 5-pocket liftwheel • Zinc-plated chain
- Clutch is located outside the load path, preventing slipping of the load in an overload condition when the brake is not powered
- Fabric chain container and rigid hook suspension standard on every Lodestar
- Hook mount standard, lug mount available upon request
- Standard lift: 10' • Lifetime warranty
- CSA approved and meets ASME B30.16 • Precision gears
- AC electrical brake or double DC brake available
- Variable speed drive (VFD) or traditional 2 speeds available

Model No.	Lift Speed FPM	Voltage	Phase	Capacity lbs.	Weight lbs.	Price /Each
LT615	16	115	1	500	53	5139.00
LT616	32	115	1	500	61	5409.00
LT617	8	115	1	1000	71	5695.00
LT618	16	115	1	1000	61	5875.00
LT619	8	115	1	2000	72	6229.00
LT620	16	115	1	2000	113	6565.00
LT621	8	115	1	4000	131	8059.00
LT624	16	575	3	500	61	5085.00
LT625	32	575	3	500	64	5359.00
LT626	8	575	3	1000	69	5579.00
LT627	16	575	3	1000	65	5875.00
LT628	16	575	3	2000	110	6509.00
LT630	8	575	3	4000	130	7955.00

Note: Additional lifts & capacities available on request



## HEAVY DUTY GOLD SERIES LEVER CHAIN HOIST

- Chain Grade: Grade 80 • Sealed bearings
- Cast latches • Chain Material: Alloy Steel
- Automatic brake engagement holding load at any height
- Light weight robust construction
- **Caution: Never exceed work load limit**

Model No.	Lift'	Capacity lbs. (tons)	Price /Each
LU617	5	500 (0.25)	240.00
LU619	5	1000 (0.5)	314.00
LU620	5	1500 (0.75)	362.00
LU622	5	3000 (1.5)	461.00
LU624	5	6000 (3)	776.00
LU618	10	500 (0.25)	268.00
LU625	10	6000 (3)	856.00
LU626	10	12 000 (6)	1364.00



## ELECTRIC CHAIN HOIST

- Multi-disc magnetic brake for positive load holding and spotting
- Adjustable upper and lower limit switches
- Overload limiting clutch and latch-type ridged top hook
- 24-volt pushbutton station fits easily in your hand to allow thumb, trigger or two-handed operation
- Made in the USA
- **5 year warranty**
- Max Lift Speed (ft./min): 16 FPM
- Min Lift Speed (ft./min): 16 FPM
- Voltage: 115V/230V
- Chain Material: Steel
- Phase: 1

Model No.	Mfg No.	Lift'	Capacity	Price /Each
TEA071	9560	10	1000 lbs. (0.5 tons)	4095.00
TEA072	9561	15	1000 lbs. (0.5 tons)	4245.00
TEA073	9562	20	1000 lbs. (0.5 tons)	4359.00
TEA074	9565	10	2000 lbs. (1 tons)	4425.00
TEA075	9566	10	2000 lbs. (1 tons)	4065.00
TEA076	9567	15	2000 lbs. (1 tons)	4519.00
TEA077	9568	20	2000 lbs. (1 tons)	4615.00
TEA078	9570	10	4000 lbs. (2 tons)	4785.00
TEA080	9572	15	4000 lbs. (2 tons)	4825.00
TEA081	9573	20	4000 lbs. (2 tons)	4985.00



## LEVER HOISTS

### SERIES 602 & 603 MINI RATCHET

The Series 602 mini hoist is the most compact ratchet lever hoist in the market

- Use in confined conditions with one hand operation
- Free chaining feature serves to quickly attach the load
- Impact resistant all-steel frame, gear case and cover

Model No.	Lift'	Capacity lbs.	Weight lbs.	Price /Each
LS706	5	550	6	375.00
LS707	5	1100	7	495.00
LS791	10	550	7	465.00
LS792	10	1100	8	605.00

Note: Additional lifts and capacities available on request

### SERIES 640 PULLER

The Series 640 long handle puller is ideal for a broad range of pulling applications

- Easy one-hand operation
- Free chaining for fast, easy attachment to load
- Tough yet lightweight aluminum construction and powder coat finish
- **Lifetime warranty**

Model No.	Lift'	Capacity lbs.	Weight lbs.	Price /Each
LS724	5	1500	17	1429.00
LS725	5	3000	26	1989.00
LS726	5	6000	38	2565.00
LS727	5	12000	73	4849.00



LS706



LS724

## HURRICANE 360° CHAIN HOISTS

- Features a patented chain guide that rotates a full 360° for operation in any direction
- Ideal for drifting applications and use in tight spaces
- Operator can safely stand away from the load at any angle, including from above the unit
- Standard overload limiter • Meets ASME B30.16

Model No.	Lift'	Capacity lbs.	Weight lbs.	Price /Each
LT634	10	1000	18.5	635.00
LT636	10	2000	26.5	715.00
LT638	10	4000	42.1	1115.00
LT640	10	6000	68	1895.00
LT635	15	1000	23	795.00
LT637	15	2000	28.7	889.00
LT639	15	4000	47.8	1305.00
LT641	15	6000	79	2155.00

Note: Additional lifts & capacities available on request



## MANUAL CHAIN HOISTS

- Simple, efficient, economical design
- Equipped with hardened load chain for flexibility and long wear
- Compact design, low headroom and lightweight steel construction for easy installation, even in confined spaces
- Brake requires no lubrication
- Forged swivel hooks with latches reduce twisting of chain and unintentional unhooking of load when chain is slack
- Standard hand chain drop is 2' less than lift

Model No.	Lift'	Cap. Tons	Wt. lbs.	Price /Each
QG621	10	1/2	18	315.00
Q1069	10	2	61	715.00
LS935	10	3	89	875.00
LS937	10	5	91	1975.00
LS930	20	1/2	30	595.00
LS932	20	1	38	645.00
LS934	20	2	80	1015.00
LS936	20	3	109	1319.00
LS938	20	5	123	2765.00

Note: Additional lifts & capacities available on request



## NYLON SLINGS

- Used in conjunction with overhead cranes, hoists or winches
- Nylon slings are available in single or double ply to protect heavy, irregular sized loads from scratching or marring
- Slings must be checked frequently
- Should any surface area show signs of wear or cutting, the sling must be replaced immediately
- Each is tagged with manufacturer's name and capacity

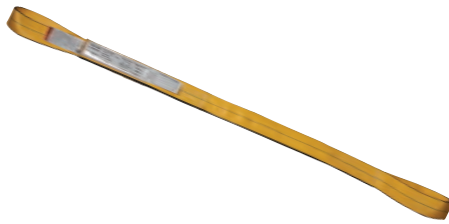

### DOUBLE EYE SLING TYPE 3

- Commonly used as a basket and/or choker hitch
- For choker hitch pass one eye through the other flat eye, also makes for easy withdrawal from beneath loads



### TWISTED EYE SLING TYPE 4

- Reverse eyes make full functional contact with lifting hooks without the use of hardware
- Widely used for both choker and basket hitches

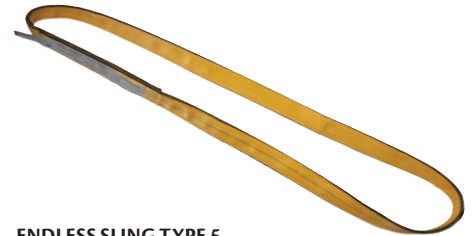

### ENDLESS SLING TYPE 5

- Most versatile and widely used sling
- The economical answer to most lifting problems
- Ideal for vertical, choker, and basket hitches

### LOAD LIMIT FOR TYPE 3-4 (LBS.)

Width"	Vertical		Choker		Basket	
	Single	Double	Single	Double	Single	Double
1	1600	3200	1280	2400	3200	6400
2	3100	6200	2480	4960	6200	12400
3	4700	8800	3760	7040	9400	17600
4	6200	11000	4960	8800	12400	22000

### LOAD LIMIT FOR TYPE 5 (LBS.)

Width"	Vertical		Choker		Basket	
	Single	Double	Single	Double	Single	Double
1	3200	6200	2560	4960	6400	12400
2	6200	12400	4960	9930	12400	24800
3	9400	17600	7520	14080	18800	35200
4	12400	22000	9920	17600	24800	44000

Type	Width"	Ply	3'		4'		6'		8'		10'		12'	
			Model No.	Price /Each	Model No.	Price /Each	Model No.	Price /Each	Model No.	Price /Each	Model No.	Price /Each	Model No.	Price /Each
Type 3	1	Single	LU292	15.60	LU293	17.50	LU294	20.60	LU295	23.50	LU296	26.90	LU297	29.90
		Double	LU316	16.00	LU317	19.00	LU318	25.00	LU319	30.90	LU320	37.50	LU321	43.50
	2	Single	LU298	21.50	LU299	23.50	LU300	27.00	LU301	32.90	LU302	37.50	LU303	41.90
		Double	LU322	20.60	LU323	25.00	LU324	34.10	LU325	42.70	LU326	51.80	LU327	60.50
	3	Single	LU304	32.50	LU305	36.90	LU306	40.90	LU307	47.90	LU308	54.50	LU309	61.50
		Double	LU328	33.50	LU329	37.90	LU330	51.90	LU331	64.90	LU332	79.90	LU333	94.50
	4	Single	LU310	45.50	LU311	51.90	LU312	57.50	LU313	63.90	LU314	72.90	LU315	82.50
		Double	LU334	48.90	LU335	54.90	LU336	70.90	LU337	90.90	LU338	119.00	LU339	135.00
Type 4	1	Single	LU340	15.50	LU341	17.50	LU342	20.50	LU343	23.50	LU344	26.90	LU345	29.90
		Double	LU364	15.90	LU365	18.90	LU366	24.90	LU367	30.90	LU368	37.50	LU369	43.50
	2	Single	LU346	21.50	LU347	23.50	LU348	28.50	LU349	32.90	LU350	38.50	LU351	56.90
		Double	LU370	20.50	LU371	24.90	LU372	33.50	LU373	42.50	LU374	51.50	LU375	60.50
	3	Single	LU352	32.50	LU353	36.90	LU354	40.90	LU355	47.90	LU356	54.50	LU357	61.50
		Double	LU376	33.50	LU377	37.90	LU378	51.90	LU379	64.90	LU380	79.90	LU381	94.50
	4	Single	LU358	45.50	LU359	51.90	LU360	57.50	LU361	63.90	LU362	72.90	LU363	82.50
		Double	LU382	48.90	LU383	54.90	LU384	70.90	LU385	90.90	LU386	119.00	LU387	135.00
Type 5	1	Single	LU388	15.50	LU389	18.90	LU390	24.90	LU391	31.50	LU392	37.90	LU393	43.50
		Double	LU412	31.50	LU413	37.90	LU414	50.90	LU415	61.90	LU416	75.50	LU417	86.50
	2	Single	LU394	23.50	LU395	27.90	LU396	37.90	LU397	47.50	LU398	57.50	LU399	66.50
		Double	LU418	36.90	LU419	46.50	LU420	64.90	LU421	82.50	LU422	99.90	LU423	119.00
	3	Single	LU400	33.50	LU401	38.90	LU402	52.50	LU403	64.50	LU404	77.90	LU405	90.90
		Double	LU424	66.50	LU425	83.50	LU426	115.00	LU427	145.00	LU428	175.00	LU429	205.00
	4	Single	LU406	39.90	LU407	47.50	LU408	63.50	LU409	79.90	LU410	95.90	LU411	115.00
		Double	LU430	83.50	LU431	109.00	LU432	145.00	LU433	179.00	LU434	219.00	LU435	249.00

Note: Other sizes, capacities and options available

## POLYESTER ROUND SLINGS

- Constructed from multiple high tenacity polyester yarns in an endless/continuous loop
- Excellent resistance to ultra-violet light, rotting and mildew
- The high flexibility allows the sling to conform to the load for a secure hold
- No loss of strength when used in water
- Lightweight, easy to rig, store and clean
- Hook and load contact points can be rotated to extend the service life
- Seamless cover, no edges to wear out
- Maximum temperature exposure: 194°F



Model No.	Width'	Length'	Colour	Capacity lbs.			Price /Each	Model No.	Width'	Length'	Colour	Capacity lbs.			Price /Each
				Vertical	Choker	90° Basket						Vertical	Choker	90° Basket	
LT569	2	4	Purple	3000	2400	6000	18.90	LT577	2	10	Yellow	9000	7200	18000	55.90
LT570	2	6	Purple	3000	2400	6000	20.90	LT578	3	6	Red	14000	11200	28000	64.90
LT571	2	8	Purple	3000	2400	6000	25.50	LT579	3	8	Red	14000	11200	28000	82.90
LT572	2	4	Green	6000	4800	12000	21.90	LT580	3	10	Red	14000	11200	28000	105.00
LT573	2	6	Green	6000	4800	12000	28.50	LT581	4	8	Blue	23000	18400	46000	139.00
LT574	2	8	Green	6000	4800	12000	36.90	LT582	4	10	Blue	23000	18400	46000	169.00
LT575	2	6	Yellow	9000	7200	18000	33.90	LT583	4	12	Blue	23000	18400	46000	205.00
LT576	2	8	Yellow	9000	7200	18000	45.50								

Note: Other lengths available upon request



# LIFTING EQUIPMENT

## POLYESTER SLINGS

- Mainly used outdoors and can withstand increases in temperature and direct sunlight (i.e. improved UV degradation resistance)
- Used in conjunction with overhead cranes, hoists or winches
- Polyester slings are available in single or double ply to protect heavy, irregular sized loads from scratching or marring
- Slings must be checked frequently
- Should any surface area show signs of wear or cutting, the sling must be replaced immediately
- Each is tagged with manufacturer's name and capacity



### DOUBLE EYE SLING TYPE 3

Commonly used as a basket and/or choker hitch or for choker hitch pass one eye through the other flat eye, also makes for easy withdrawal from beneath loads

### TWISTED EYE SLING TYPE 4

Reverse eyes make full functional contact with lifting hooks without the use of hardware. Widely used for both choker and basket hitches

### ENDLESS SLING TYPE 5

Most versatile and widely used sling. The economical answer to most lifting problems. Ideal for vertical, choker and basket hitches

### LOAD LIMIT FOR TYPE 3-4 (LBS.)

Width"	Vertical		Choker		Basket	
	Single	Double	Single	Double	Single	Double
1	1600	3200	1280	2400	3200	6400
2	3100	6200	2480	4960	6200	12400
3	4700	8800	3760	7040	9400	17600
4	6200	11000	4960	8800	12400	22000

### LOAD LIMIT FOR TYPE 5 (LBS.)

Width"	Vertical		Choker		Basket	
	Single	Double	Single	Double	Single	Double
1	3200	6200	2560	4960	6400	12400
2	6200	12400	4960	9930	12400	24800
3	9400	17600	7520	14080	18800	35200
4	12400	22000	9920	17600	24800	44000

Type	Width"	Ply	3' Model No.	Price /Each	4' Model No.	Price /Each	6' Model No.	Price /Each	8' Model No.	Price /Each	10' Model No.	Price /Each	12' Model No.	Price /Each	
TYPE 3	1	Single	LU116	10.50	LU117	11.60	LU118	14.00	LU119	16.60	LU120	16.50	LU121	21.50	
		Double	LU140	11.90	LU141	14.00	LU142	17.60	LU143	22.90	LU144	26.50	LU145	32.50	
	2	Single	LU122	16.50	LU123	18.60	LU124	22.60	LU125	26.90	LU126	30.90	LU127	33.90	
		Double	LU146	15.90	LU147	19.60	LU148	27.60	LU149	35.70	LU150	42.70	LU151	49.50	
	3	Single	LU128	26.50	LU129	28.90	LU130	34.90	LU131	37.90	LU132	39.90	LU133	45.50	
		Double	LU152	28.90	LU153	33.90	LU154	45.50	LU155	54.50	LU156	64.50	LU157	74.90	
	4	Single	LU134	34.90	LU135	37.90	LU136	45.50	LU137	53.50	LU138	60.90	LU139	64.50	
		Double	LU158	43.50	LU159	43.90	LU160	55.90	LU161	68.90	LU162	87.90	LU163	105.00	
	TYPE 4	1	Single	LU164	10.50	LU165	11.90	LU166	14.50	LU167	17.50	LU168	17.50	LU169	21.90
			Double	LU188	11.90	LU189	13.90	LU190	17.50	LU191	22.90	LU192	26.50	LU193	32.50
		2	Single	LU170	16.50	LU171	18.50	LU172	22.50	LU173	26.90	LU174	30.90	LU175	33.90
			Double	LU194	14.90	LU195	19.50	LU196	27.50	LU197	35.50	LU198	42.50	LU199	49.50
3		Single	LU176	26.50	LU177	28.90	LU178	34.90	LU179	37.90	LU180	39.90	LU181	45.50	
		Double	LU200	28.90	LU201	33.90	LU202	45.50	LU203	54.50	LU204	64.50	LU205	74.90	
4		Single	LU182	34.90	LU183	37.90	LU184	45.50	LU185	53.50	LU186	60.90	LU187	64.50	
		Double	LU206	43.50	LU207	43.90	LU208	55.90	LU209	70.50	LU210	87.90	LU211	105.00	
TYPE 5		1	Single	LU212	11.50	LU213	13.00	LU214	17.50	LU215	22.50	LU216	26.50	LU217	28.90
			Double	LU236	20.50	LU237	25.90	LU238	35.50	LU239	43.50	LU240	50.50	LU241	58.50
		2	Single	LU218	16.50	LU219	20.50	LU220	25.90	LU221	32.50	LU222	37.50	LU223	43.50
			Double	LU242	32.50	LU243	40.50	LU244	55.90	LU245	69.90	LU246	85.50	LU247	98.90
	3	Single	LU224	27.50	LU225	32.90	LU226	42.50	LU227	51.50	LU228	62.50	LU229	73.50	
		Double	LU248	47.90	LU249	57.90	LU250	75.50	LU251	94.50	LU252	115.00	LU253	135.00	
	4	Single	LU230	31.50	LU231	38.50	LU232	49.90	LU233	61.50	LU234	73.90	LU235	85.50	
		Double	LU254	58.90	LU255	70.90	LU256	95.90	LU257	125.00	LU258	149.00	LU259	175.00	

## CHAIN SLINGS

- Quality grade 80 alloy steel assembled, feature a design factor of 4:1
- Proof tested and certified to twice the working load limit
- Proof test certificate issued with each sling
- Available with sling hook or grab hook
- Slings comes with identification tag indicating size, description and working load limit



Sling Hook



Grab hook



Chain Size"	Hook Type	5' Sling Model No.	Price /Each	8' Sling Model No.	Price /Each	10' Sling Model No.	Price /Each
9/32	Sling	LV732	142.00	LV744	163.00	LV756	177.00
9/32	Grab	LV696	125.00	LV708	146.00	LV720	163.00
3/8	Sling	LV734	226.00	LV746	236.00	LV758	261.00
3/8	Grab	LV698	188.00	LV710	219.00	LV722	240.00
1/2	Sling	LV735	324.00	LV747	383.00	LV759	419.00
1/2	Grab	LV699	282.00	LV711	335.00	LV723	373.00
5/8	Grab	LV700	429.00	LV712	513.00	LV724	566.00

Chain Size"	Hook Type	5' Sling Model No.	Price /Each	8' Sling Model No.	Price /Each	10' Sling Model No.	Price /Each
DOUBLE CHAIN							
9/32	Sling	LV840	230.00	LV852	282.00	LV864	314.00
9/32	Grab	LV804	205.00	LV816	247.00	LV828	278.00
3/8	Sling	LV842	342.00	LV854	415.00	LV866	461.00
3/8	Grab	LV806	303.00	-	-	LV830	415.00
1/2	Sling	-	-	-	-	LV867	744.00
1/2	Grab	LV807	471.00	LV819	583.00	LV831	656.00
5/8	Grab	-	-	-	-	LV832	1097.00

Note: Other lengths, hook types and chain types available upon request

### CAPACITY LBS.

Chain Size"	Single		
	90°	60°	45°
9/32	3500	6100	4900
3/8	7100	12300	10000
1/2	12000	20800	17000
5/8	18100	31300	25600

## STRAIGHT LINK CHAINS

### GRADE 30

- Design factor 4:1
- 100% welded chain
- Material: Low Carbon Steel
- Grade 30 chain must not be used for overhead lifting
- Priced per drum



### LU925 - Self-Coloured



### LU928 - Hot-Dip Galvanized



### LU935 - Zinc Plated



VANGUARD STEEL LTD.

Model No.	Chain Length	Trade Size"	Finish	Working Load Limit	Price /Each
LU919	1000' (304.8 m)	1/8	Self-Coloured	400 lbs. (0.2 tons)	839.00
LU920	750' (228.6 m)	3/16	Self-Coloured	800 lbs. (0.4 tons)	1049.00
LU922	250' (76.2 m)	5/16	Self-Coloured	1900 lbs. (0.95 tons)	761.00
LU923	175' (53.3 m)	3/8	Self-Coloured	2650 lbs. (1.325 tons)	919.00
LU924	100' (30.5 m)	1/2	Self-Coloured	4500 lbs. (2.25 tons)	965.00
LU925	100' (30.5 m)	3/4	Self-Coloured	10 600 lbs. (5.3 tons)	2200.00
LU926	1000' (304.8 m)	1/8	Hot-Dip Galvanized	400 lbs. (0.2 tons)	1171.00
LU927	750' (228.6 m)	3/16	Hot-Dip Galvanized	800 lbs. (0.4 tons)	1444.00
LU928	350' (106.7 m)	1/4	Hot-Dip Galvanized	1300 lbs. (0.65 tons)	1080.00
LU929	250' (76.2 m)	5/16	Hot-Dip Galvanized	1900 lbs. (0.95 tons)	1045.00
LU930	175' (53.3 m)	3/8	Hot-Dip Galvanized	2650 lbs. (1.325 tons)	1097.00
LU931	100' (30.5 m)	1/2	Hot-Dip Galvanized	4500 lbs. (2.25 tons)	1129.00
LU932	150' (45.7 m)	5/8	Hot-Dip Galvanized	6900 lbs. (3.45 tons)	2550.00
LU933	100' (30.5 m)	3/4	Hot-Dip Galvanized	10 600 lbs. (5.3 tons)	2746.00
LU934	100' (30.5 m)	1	Hot-Dip Galvanized	17 900 lbs. (8.95 tons)	4573.00
LU935	1000' (304.8 m)	1/8	Zinc Plated	400 lbs. (0.2 tons)	881.00
LU936	750' (228.6 m)	3/16	Zinc Plated	800 lbs. (0.4 tons)	1087.00
LU937	350' (106.7 m)	1/4	Zinc Plated	1300 lbs. (0.65 tons)	803.00
LU938	250' (76.2 m)	5/16	Zinc Plated	1900 lbs. (0.95 tons)	856.00
LU939	175' (53.3 m)	3/8	Zinc Plated	2650 lbs. (1.325 tons)	1038.00
LU940*	350' (106.7 m)	1/8	Zinc Plated	400 lbs. (0.2 tons)	324.00
LU941*	250' (76.2 m)	3/16	Zinc Plated	800 lbs. (0.4 tons)	362.00
LU942*	140' (42.7 m)	1/4	Zinc Plated	1300 lbs. (0.65 tons)	332.00
LU943*	90' (27.4 m)	5/16	Zinc Plated	1900 lbs. (0.95 tons)	341.00
LU944*	63' (19.2 m)	3/8	Zinc Plated	2650 lbs. (1.325 tons)	373.00

\* Priced per pail

## GRADE 70 TRANSPORT CHAIN

- Commonly used as a binder tie down chain, meeting the stringent Department of Transportation requirements
- Permanently embossed with L7 or V7 every 6 links
- 100% Welded chain
- Must not be used for overhead lifting
- Chain Grade: Grade 70
- Material: Heat-Treated Carbon Steel
- Finish: Gold Chromate Plated
- **Sold and priced per foot, minimum 25' chain length is required**



VANGUARD STEEL LTD.



Model No.	Trade Size"	Working Load Limit	Price /Each
<b>IMPORTED</b>			
LV373	1/4	3150 lbs. (1.57 tons)	5.66
LV374	5/16	4700 lbs. (2.35 tons)	8.18
LV375	3/8	6600 lbs. (3.3 tons)	11.00
LV376	1/2	11300 lbs. (5.65 tons)	18.80
<b>USA MADE</b>			
LV377	1/4	3150 lbs. (1.57 tons)	9.02
LV378	5/16	4700 lbs. (2.35 tons)	10.40
LV379	3/8	6600 lbs. (3.3 tons)	13.50
LV380	1/2	11300 lbs. (5.65 tons)	27.20

## STRAIGHT LINK LIFTING CHAINS

- Design factor 4:1 (in accordance with NACM specifications)
- Produced from the highest quality domestic alloy steel
- Material: Heat-Treated Alloy Steel
- 100% welded chain
- Approved for overhead lifting
- Meets the specifications of NACM, ASTM and O.S.H.A.
- **Sold and priced per foot, minimum 25' chain length is required\***

Never exceed WLL, always use Grade 80 or higher chains for overhead lifting

### GRADE 80

- Permanently embossed with L8 (grade) and trace code every 6 alternating links
- Black coated finish



LU949

### GRADE 100

- Permanently embossed with L10 (grade) and trace code every 6 alternating links
- 25% higher working load limit than comparable Grade 80 alloy chain
- Grey coated finish



LU954



VANGUARD STEEL LTD.

Model No.	Trade Size"	Working Load Limit	Price /Foot*
<b>GRADE 80</b>			
LU945	9/32	3500 lbs. (1.75 tons)	14.20
LU946	5/16	4500 lbs. (2.25 tons)	17.30
LU947	3/8	7100 lbs. (3.55 tons)	20.50
LU948	1/2	12 000 lbs. (6 tons)	34.50
LU949	5/8	18 100 lbs. (9.05 tons)	49.90
LU950	3/4	28 300 lbs. (14.15 tons)	110.00
LU951	7/8	34 300 lbs. (17.15 tons)	142.00
LU952	1	47 700 lbs. (23.85 tons)	194.00
<b>GRADE 100</b>			
LU953	9/32	4300 lbs. (2.15 tons)	14.60
LU954	3/8	8800 lbs. (4.4 tons)	21.90
LU955	1/2	15000 lbs. (7.5 tons)	37.30
LU956	5/8	22600 lbs. (11.3 tons)	56.20

## TENSO LION DOUBLE LOOP CHAINS

- General purpose weld-less utility chain
- Commonly used for hardware and manufacturing applications
- Can be used on playgrounds, gym equipment, light fixtures, gates and more
- Material: Low Carbon Steel
- Finish: Zinc Plated



VANGUARD STEEL LTD.

Model No.	Chain Length	Trade Size	Working Load Limit	Price /Each
LU957	100' (30.5 m)	#1	155 lbs. (0.077 tons)	66.80
LU958	200' (61 m)	#3	90 lbs. (0.045 tons)	94.00
LU959	250' (76.2 m)	#4	70 lbs. (0.035 tons)	110.00
LU960	175' (53.3 m)	2/0	255 lbs. (0.127 tons)	156.00

## SINGLE JACK CHAINS

- General purpose weld-less light-duty chain
- Commonly used for general applications where high strength is not required
- Can be used on light fixtures, flower pots and more
- Material: Low Carbon Steel
- Finish: Zinc Plated



VANGUARD STEEL LTD.

Model No.	Chain Length	Trade Size	Working Load Limit	Price /Each
LU961	250' (76.2 m)	#10	43 lbs. (0.022 tons)	205.00
LU962	100' (30.5 m)	#12	29 lbs. (0.0145 tons)	60.70

## CLEVIS HOOKS

### GRADE 40

- For use with Grade 40 or lower chains only
- Self-coloured body with "gold-pin"
- Material: Forged Carbon

Not for use with overhead lifting applications

Model No.	For Chain Diameter Size"	Working Load Limit	Price /Each
-----------	--------------------------	--------------------	-------------

#### CLEVIS GRAB HOOK

LV052	1/4	2600 lbs. (1.3 tons)	5.97
LV053	5/16	3900 lbs. (1.95 tons)	8.18
LV054	3/8	5400 lbs. (2.7 tons)	9.99
LV055	7/16	7200 lbs. (3.6 tons)	15.20
LV056	1/2"	9200 lbs. (4.6 tons)	23.00

#### CLEVIS SLING HOOK

LV034	1/4	1950 lbs. (0.975 tons)	5.97
LV035	5/16	2875 lbs. (1.43 tons)	7.23
LV036	3/8	4000 lbs. (2 tons)	10.10
LV037	1/2	6000 lbs. (3 tons)	23.60

### GRADE 70

- For use with Grade 70 or lower chains only
- Gold Chromate body with "black-pin"
- Material: Alloy Steel

Not for use with overhead lifting applications

Model No.	For Chain Diameter Size"	Working Load Limit	Price /Each
-----------	--------------------------	--------------------	-------------

#### CLEVIS GRAB HOOK

LV057	1/4	3150 lbs. (1575 tons)	4.92
LV059	5/16	4700 lbs. (2.35 tons)	6.93
LV061	3/8	6600 lbs. (3.3 tons)	8.83
LV063	7/16	8800 lbs. (4.4 tons)	14.60
LV064	1/2	11300 lbs. (5.65 tons)	20.50

#### CLEVIS GRAB HOOK W/LATCH

LV058	1/4	3150 lbs. (1575 tons)	9.02
LV060	5/16	4700 lbs. (2.35 tons)	12.50
LV062	3/8	6600 lbs. (3.3 tons)	16.70
LV065	1/2	11300 lbs. (5.65 tons)	28.50

#### CLEVIS SLING HOOK

LV038	1/4	2750 lbs. (1.375 tons)	6.29
LV040	5/16	4300 lbs. (2.15 tons)	9.96
LV042	3/8	5250 lbs. (2.625 tons)	13.20
LV044	7/16	7000 lbs. (3.5 tons)	22.60
LV046	1/2	9000 lbs. (4.5 tons)	29.30

#### CLEVIS SLING HOOK W/LATCH

LV039	1/4	2750 lbs. (1.375 tons)	8.49
LV041	5/16	4300 lbs. (2.15 tons)	12.10
LV043	3/8	5250 lbs. (2.625 tons)	14.20
LV045	7/16	7000 lbs. (3.5 tons)	25.10
LV047	1/2	9000 lbs. (4.5 tons)	34.20



### GRADE 80 & 100

- Permanently embossed with VDG, size, model number and trace code
- Proof tested to 2.5 times the Working Load Limit (WLL)
- Material: Alloy Steel
- Meets or exceeds ASTM A-952-96 standard
- Meets EN1677 standard (20,000 cycle fatigue test)



### GRADE 80

Model No.	For Chain Diameter Size"	Working Load Limit	Price /Each
-----------	--------------------------	--------------------	-------------

#### CLEVIS GRAB HOOK

LU841	5/16	4500 lbs. (2.25 tons)	29.30
LU842	3/8	7100 lbs. (3.55 tons)	49.90
LU843	1/2	12000 lbs. (6 tons)	83.50
LU844	5/8	18100 lbs. (9.05 tons)	188.00
LU845	3/4	28300 lbs. (14.15 tons)	272.00
LU846	7/8	34200 lbs. (17.1 tons)	436.00

#### CLEVIS SLING HOOK W/LATCH

LU847	5/16	4500 lbs. (2.25 tons)	49.90
LU848	3/8	7100 lbs. (3.55 tons)	83.50
LU849	1/2	12000 lbs. (6 tons)	135.00
LU850	5/8	18100 lbs. (9.05 tons)	293.00
LU851	3/4	28300 lbs. (14.15 tons)	429.00
LU852	7/8	34200 lbs. (17.1 tons)	614.00

#### CLEVIS SLING HOOK W/LOCKING LATCH

LU853	5/16	4500 lbs. (2.25 tons)	89.80
LU854	3/8	7100 lbs. (3.55 tons)	142.00
LU855	1/2	12000 lbs. (6 tons)	215.00
LU856	5/8	18100 lbs. (9.05 tons)	341.00
LU857	3/4	28300 lbs. (14.15 tons)	692.00

### GRADE 100

Model No.	For Chain Diameter Size"	Working Load Limit	Price /Each
-----------	--------------------------	--------------------	-------------

#### CLEVIS GRAB HOOK

LU877	5/16	5700 lbs. (2.85 tons)	31.40
LU878	3/8	8800 lbs. (4.4 tons)	53.40
LU879	1/2	15000 lbs. (7.5 tons)	89.10
LU880	5/8	22600 lbs. (11.3 tons)	209.00

#### CLEVIS SLING HOOK W/LATCH

LU881	5/16	5700 lbs. (2.85 tons)	53.00
LU882	3/8	8800 lbs. (4.4 tons)	88.70
LU883	1/2	15000 lbs. (7.5 tons)	146.00
LU884	5/8	22600 lbs. (11.3 tons)	314.00

#### CLEVIS SLING HOOK W/LOCKING LATCH

LU885	5/16	5700 lbs. (2.85 tons)	96.50
LU886	3/8	8800 lbs. (4.4 tons)	152.00
LU887	1/2	15000 lbs. (7.5 tons)	236.00
LU888	5/8	22600 lbs. (11.3 tons)	366.00



## SELF LOCKING SWIVEL HOOKS

- Permanently embossed with VDG, size, model number and trace code
- Proof tested to 2.5 times the Working Load Limit (WLL)
- Material: Alloy Steel
- Meets or exceeds ASTM A-952-96 standard
- Meets EN1677 standard (20,000 cycle fatigue test)



Model No.	For Chain Diameter Size"	Working Load Limit	Price /Each
-----------	--------------------------	--------------------	-------------

#### GRADE 80, EYE & SELF-LOCKING HOOK

LU862	5/16	4500 lbs. (2.25 tons)	121.00
LU863	3/8	7100 lbs. (3.55 tons)	177.00
LU864	1/2	12000 lbs. (6 tons)	261.00
LU865	5/8	18100 lbs. (9.05 tons)	450.00
LU866	3/4	28300 lbs. (14.15 tons)	1150.00

#### GRADE 100, EYE & SELF-LOCKING HOOK

LU893	5/16	5700 lbs. (2.85 tons)	135.00
LU894	3/8	8800 lbs. (4.4 tons)	194.00
LU895	1/2	15000 lbs. (7.5 tons)	303.00
LU896	5/8	22600 lbs. (11.3 tons)	530.00

## COUPLING LINKS

- Permanently embossed with VDG, size, model number and trace code
- Proof tested to 2.5 times the Working Load Limit (WLL)
- Material: Alloy Steel
- Meets or exceeds ASTM A-952-96 standard
- Meets EN1677 standard (20,000 cycle fatigue test)



Model No.	For Chain Diameter Size"	Capacity lbs.	Price /Each
-----------	--------------------------	---------------	-------------

#### GRADE 80

LU867	9/32	3500	26.80
LU868	3/8	7100	34.10
LU869	1/2	12000	50.90
LU870	5/8	18100	76.50
LU871	3/4	28300	177.00
LU872	7/8	34200	320.00

#### GRADE 100

LU873	9/32	4300	29.30
LU874	3/8	8800	36.60
LU875	1/2	15000	54.50
LU876	5/8	22600	81.40





## SNATCH BLOCKS

- Fittings are painted yellow for quick recognition
- Designed for intermittent use with low line speed
- Ultimate load 4 times working load limit (WLL)
- Bronze bush with grease nipple



Model No.	For Rope Diameter"	Sheave Diameter"	Working Load Limit	Price /Each
<b>HOOK &amp; LATCH</b>				
LU897	3/8	3	4000 lbs. (2 tons)	111.00
LU898	1/2	4-1/2	8000 lbs. (4 tons)	205.00
LU899	3/4	6	16000 lbs. (8 tons)	352.00
LU900	3/4	8	16000 lbs. (8 tons)	383.00
LU901	3/4	10	16000 lbs. (8 tons)	509.00
LU902	1-1/8	8	30000 lbs. (15 tons)	629.00
<b>SWIVEL SHACKLE</b>				
LU904	3/8	3	4000 lbs. (2 tons)	114.00
LU905	1/2	4-1/2	8000 lbs. (4 tons)	198.00
LU906	3/4	6	16000 lbs. (8 tons)	377.00
LU907	3/4	8	16000 lbs. (8 tons)	450.00
LU908	3/4	10	16000 lbs. (8 tons)	555.00
LU910	1-1/8	8	30000 lbs. (15 tons)	656.00
<b>TAILBOARD W/PIN ONLY</b>				
LU913	3/8	3	4000 lbs. (2 tons)	77.20
LU914	1/2	4-1/2	8000 lbs. (4 tons)	135.00
LU915	3/4	6	16000 lbs. (8 tons)	230.00
LU916	3/4	8	16000 lbs. (8 tons)	278.00



## SCREW PIN CHAIN SHACKLES

- Heat treated carbon steel bows, quenched and tempered with Alloy pins
- Shackle Bow Finish: Hot Dip Galvanized
- Meets the performance requirements of U.S. Fed. Spec. RR-C-271D, ASME B30.26, Type 4A, Class 2 Grade A



Model No.	Size"	Pin Diameter"	Capacity	Price /Each
LU773	3/8	7/16	2000 lbs. (1 tons)	4.82
LU774	7/16	1/2	3000 lbs. (1.5 tons)	6.29
LU775	1/2	5/8	4000 lbs. (2 tons)	7.02
LU776	5/8	3/4	6500 lbs. (3.25 tons)	14.20
LU777	3/4	7/8	9500 lbs. (4.75 tons)	23.00
LU779	1	1-1/8	17000 lbs. (8.5 tons)	41.50
LU781	1-1/4	1-3/8	24000 lbs. 12 tons)	81.40
LU782	1-1/2	1-5/8	34000 lbs. (17 tons)	142.00



LU773

## LIFTING SWIVEL HOIST RINGS

- Designed for angular lifting
- Hoist rings resist stresses that would bend or break an eyebolt
- Pivots 180° front to back and a base that swivels 360°
- Working load limit and nominal size meet ASME B 30.26 standards
- The proof load is 2 x Working load limit and Minimum Breaking Strength is 4 x Working Load Limit
- Made from grade 80 alloy steel



LU815

Model No.	Thread Size	Thread Length mm	Working Load Limit	Working Load Limit at 90° Angle	Price /Each
LU815	M8	13	1200 lbs. (0.6 tons)	600 lbs. (0.3 tons)	52.40
LU817	M10	18	1800 lbs. (0.9 tons)	900 lbs. (0.45 tons)	55.10
LU819	M12	20	2000 lbs. (1 tons)	1000 lbs. (0.5 tons)	60.40
LU822	M16	30	4000 lbs. (2 tons)	2240 lbs. (1.12 tons)	56.60
LU824	M20	30	8000 lbs. (4 tons)	4000 lbs. (2 tons)	101.00
LU826	M24	30	12600 lbs. (6.3 tons)	6300 lbs. (3.15 tons)	146.00
LU828	M30	35	21200 lbs. (10.6 tons)	10600 lbs. (5.3 tons)	230.00
LU830	M36	54	23600 lbs. (11.8 tons)	23600 lbs. (11.8 tons)	341.00
LU831	1/4"	13	1200 lbs. (0.6 tons)	606 lbs. (0.9 tons)	52.00
LU832	5/16"	13	1320 lbs. (0.66 tons)	661 lbs. (0.33 tons)	56.60
LU833	3/8"	18	1980 lbs. (0.99 tons)	1100 lbs. (0.55 tons)	65.00
LU834	7/16"	18	2200 lbs. (1.1 tons)	1100 lbs. (0.55 tons)	56.60
LU835	1/2"	20	2200 lbs. (1.1 tons)	1100 lbs. (0.55 tons)	62.10
LU836	5/8"	20	4400 lbs. (2.2 tons)	2469 lbs. (1.23 tons)	58.00
LU837	3/4"	30	8810 lbs. (4.4 tons)	4400 lbs. (2.2 tons)	114.00
LU838	7/8"	30	1100 lbs. (0.55 tons)	5510 lbs. (2.755 tons)	156.00
LU839	1"	30	13880 lbs. (6.94 tons)	6945 lbs. (3.47 tons)	156.00
LU840	1-1/4"	50	26000 lbs. (13 tons)	17637 lbs. (8.8 tons)	356.00

## SCREW PIN ANCHOR SHACKLES

- Heat treated carbon steel bows, quenched and tempered with Alloy pins
- Meets the performance requirements of U.S. Fed. Spec. RR-C-271D, ASME B30.26, Type 4A, Class 2 Grade B



Model No.	Size"	Pin Diameter"	Capacity	Price /Each
<b>YELLOW CHROMATE PLATED</b>				
LU729	3/8	7/16	4000 lbs. (2 tons)	7.33
LU730	7/16	1/2	5300 lbs. (2.65 tons)	8.76
LU731	1/2	5/8	6600 lbs. (3.3 tons)	11.10
LU732	5/8	3/4	10000 lbs. (5 tons)	19.30
LU733	3/4	7/8	14000 lbs. (7 tons)	29.50
LU734	7/8	1	19000 lbs. (9.5 tons)	44.60
LU735	1	1-1/8	25000 lbs. (12.5 tons)	66.70
LU736	1-1/8	1-1/4	30000 lbs. (15 tons)	91.20
LU737	1-1/4	1-3/8	36000 lbs. (18 tons)	125.00
LU738	1-1/2	1-5/8	60000 lbs. (30 tons)	219.00



LU729

Model No.	Size"	Pin Diameter"	Capacity	Price /Each
<b>HOT DIP GALVANIZED</b>				
LU739	3/16	1/4	660 lbs. (0.33 tons)	3.35
LU740	1/4	5/16	1000 lbs. (0.5 tons)	4.07
LU741	5/16	3/8	1500 lbs. (0.75 tons)	4.78
LU742	3/8	7/16	2000 lbs. (1 tons)	6.22
LU743	7/16	1/2	3000 lbs. (1.5 tons)	7.63
LU744	1/2	5/8	4000 lbs. (2 tons)	9.54
LU745	5/8	3/4	6500 lbs. (3.25 tons)	17.60
LU746	3/4	7/8	9500 lbs. (4.75 tons)	25.60
LU747	7/8	1	13000 lbs. (6.5 tons)	36.20
LU748	1	1-1/8	17000 lbs. (8.5 tons)	53.60
LU749	1-1/8	1-1/4	19000 lbs. (9.5 tons)	73.00
LU750	1-1/4	1-3/8	24000 lbs. 12 tons)	98.80
LU751	1-3/8	1-1/2	27000 lbs. (13.5 tons)	135.00
LU752	1-1/2	1-5/8	34000 lbs. (17 tons)	177.00
LU753	1-3/4	2	50000 lbs. (25 tons)	345.00
LU754	2	2-1/4	70000 lbs. (35 tons)	541.00
LU755	2-1/2	2-3/4	110000 lbs. (55 tons)	1080.00



LU739

## STAINLESS STEEL

- To be used for light duty, non-critical applications only
- Made from AISI-316 stainless steel
- Bright polished finish

Model No.	Size"	Pin Diameter"	Capacity	Price /Each
LU787	1/4	5/16	500 lbs. (0.25 tons)	5.55
LU788	5/16	3/8	660 lbs. (0.33 tons)	7.65
LU789	3/8	7/16	1000 lbs. (0.5 tons)	11.40
LU791	1/2	5/8	2000 lbs. (1 tons)	26.10
LU792	5/8	3/4	3000 lbs. (1.5 tons)	50.90
LU793	3/4	7/8	4500 lbs. (2.25 tons)	73.40
LU795	1	1-1/8	8000 lbs. (4 tons)	152.00



LU787

## BOLT TYPE ANCHOR SHACKLES

- Heat treated carbon steel bows, quenched and tempered with Alloy pins
- Shackle Bow Finish: Hot Dip Galvanized
- Meets the performance requirements of U.S. Fed. Spec. RR-C-271D, ASME B30.26, Type 4A, Class 3 Grade A
- Recommended for long term service installation as well as for applications where there is the possibility that the pin can rotate under load





Model No.	Size"	Pin Diameter"	Capacity	Price /Each
LU756	1/4	5/16	1000 lbs. (0.5 tons)	4.82
LU757	5/16	3/8	1500 lbs. (0.75 tons)	5.76
LU758	3/8	7/16	2000 lbs. (1 tons)	8.39
LU759	7/16	1/2	3000 lbs. (1.5 tons)	10.10
LU760	1/2	5/8	4000 lbs. (2 tons)	12.50
LU761	5/8	3/4	6500 lbs. (3.25 tons)	22.30
LU762	3/4	7/8	9500 lbs. (4.75 tons)	33.60
LU763	7/8	1	13000 lbs. (6.5 tons)	49.90
LU764	1	1-1/8	17000 lbs. (8.5 tons)	63.90
LU765	1-1/8	1-1/4	19000 lbs. (9.5 tons)	83.50
LU766	1-1/4	1-3/8	24000 lbs. 12 tons)	121.00
LU767	1-3/8	1-1/2	27000 lbs. (13.5 tons)	184.00
LU768	1-1/2	1-5/8	34000 lbs. (17 tons)	257.00
LU769	1-3/4	2	50000 lbs. (25 tons)	457.00
LU770	2	2-1/4	70000 lbs. (35 tons)	656.00



LU756

# LIFTING EQUIPMENT

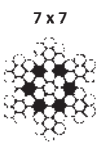
## GALVANIZED AIRCRAFT CABLES

Dia."	Breaking Strength lbs.		Model No.	Feet Per Pkg.	Price /Each	Model No.	Feet Per Pkg.	Price /Each
3/64	270		LA893	100	13.90	LB030	500	45.90
1/16	480		LA894	100	14.50	LB031	500	61.90
5/64	650		LA895	100	16.50	LB032	500	59.90
3/32	920		LA896	100	22.90	LB033	500	62.90
1/8	1700		LA897	100	22.50	LB034	500	109.00
5/32	2600		LA898	100	41.90	LB035	500	169.00
3/16	3700		LA899	100	47.90	LB036	500	219.00
1/4	6100		LA900	100	79.90	LB037	500	379.00
3/32	1000			LA902	100	30.50	LB039	500
1/8	2000	LA903		100	30.90	LB040	500	139.00
5/32	2800	LA904		100	40.50	LB041	500	179.00
3/16	4200	LA905		100	49.99	LB042	500	229.00
1/4	7000	LA906		100	84.90	LB043	500	369.00
5/16	9800	LA907		100	119.00	LB044	500	559.00
3/8	14400	LA908		100	159.00	LB045	500	749.00
1/2	20700	LA909		100	289.00	LB046	500	1529.00

Special sizes available on request

## COATED GALVANIZED CABLE (PVC)

Model No.	Outside Dia."	Inside Dia."	Construction	Colour	Feet Per Pkg.	Price /Each
LA910	3/16	1/8	7 x 19	Clear	100	51.90
LA911	3/16	1/8	7 x 19	Red	100	46.90

Special sizes available on request

## TURNBUCKLES

Eye & Eye Model No.	Jaw & Jaw Model No.	Diameter Take-Up"	Working Load Limit lbs. E & E	J & J	Wt. lbs.	Eye & Eye Price/Each	Jaw & Jaw Price/Each
LA947	MMS321	5/16 x 4 1/4	800	700	0.45	11.50	11.50
LA948	MMS322	3/8 x 6	1200	1000	0.75	14.50	16.50
LA949	MMS323	1/2 x 6	2200	1500	1.5	23.50	24.90
LA950	MMS324	1/2 x 9	2200	1500	1.75	26.50	31.50
LA951	MMS325	1/2 x 12	2200	1500	2.18	32.50	40.90
LA952	MMS326	5/8 x 6	3500	2250	2.63	36.90	38.50
LA953	MMS327	5/8 x 9	3500	2250	3	37.90	44.90
LA954	MMS328	5/8 x 12	3500	2250	3.25	44.90	50.90
LA955	MMS329	3/4 x 6	5200	3000	3.75	51.90	58.90
LA956	MMS330	3/4 x 9	5200	3000	4.5	58.90	63.90
LA957	MMS331	3/4 x 12	5200	3000	5.75	69.90	74.90
LA958	MMS332	7/8 x 12	7200	4000	8.35	65.90	109.00
LA959	MMS333	1 x 6	10000	5000	9.04	125.00	129.00

## EYE BOLTS

Model No.	Dia. & Take-up"	Working Load Limit lbs.	Price /Each
<b>REGULAR NUT EYE BOLTS (Galvanized, Drop-Forged)</b>			
LA974	5/16 x 4 1/4	800	4.39
LA975	3/8 x 2 1/2	1200	4.19
LA976	3/8 x 4 1/2	1200	5.29
LA977	1/2 x 8	2200	11.50
LA978	1/2 x 10	2200	12.50
LA979	5/8 x 4	3500	11.90
LA980	5/8 x 12	3500	22.50

Model No.	Dia. & Take-up"	Working Load Limit lbs.	Price /Each
<b>SHOULDER NUT EYE BOLT (Galvanized, Drop-Forged)</b>			
LA981	3/8 x 2 1/2	1200	4.19
<b>SHOULDER TYPE MACHINERY EYE BOLTS (Steel)</b>			
LU482	3/8 x 1 1/4	1300	3.00
LU483	1/2 x 1 1/2	2400	4.61
LU484	5/8 x 1 3/4	4000	7.63

## CARBINE SNAP HOOKS (STAINLESS STEEL 316)

**KLETON**

Model No.	Size"	Length"	Eye"	Working Load Limit lbs.	Price /Each
LW272	3/16	2	5/16	220	2.10
LW273	3/16	2	5/16	220	0.65
LW274	1/4	2 3/8	3/8	260	2.60
LW275	5/16	3-3/16	1/2	500	1.10
LW276	5/16	3 3/16	1/2	500	4.70
LW277	3/8	3 15/16	5/8	770	7.75

## QUICK LINKS (ZINC-PLATED)

**KLETON**

Model No.	Size"	Working Load Limit lbs.	Price /Each
LW266	1/8	220	0.55
LW267	3/16	660	0.75
LW268	1/4	880	0.90
LW269	5/16	1760	1.65
LW270	3/8	2140	2.60
LW271	1/2	3300	4.30

## ALUMINUM OVAL SLEEVES

Model No.	For Cable Dia."	Price /Each	Model No.	For Cable Dia."	Price /Each
LA912	1/32	0.09	LA919	3/16	0.48
LA913	3/64	0.12	LA920	1/4	0.87
LA914	1/16	0.12	LA921	5/16	1.40
LA915	5/64	0.19	LA922	3/8	1.99
LA916	3/32	0.12	LA923	7/16	3.39
LA917	1/8	0.24	LA924	1/2	5.69
LA918	5/32	0.26			

## ALUMINUM STOP SLEEVES

Model No.	For Cable Dia."	Price /Each	Model No.	For Cable Dia."	Price /Each
LA925	1/16	0.23	LA929	3/16	0.18
LA926	3/32	0.18	LA930	1/4	0.97
LA927	1/8	0.23	LA931	5/16	0.19
LA928	5/32	0.27	LA932	3/8	0.82

## THIMBLES

Model No.	For Cable Dia."	Type	Price /Each
LA933	3/64-1/16 - 5/64	AN	0.38
LA934	3/32 - 7/64 - 1/8	AN	0.38
LA935	5/32	AN	0.60
LA936	3/16	AN	0.67
LA939	1/4	AN	0.83
LA940	5/16	STD	0.57
LA941	3/8	STD	0.77
LA942	1/2	STD	1.38
LA943	5/8	STD	3.29
LA944	3/4	STD	4.59
LA945	1	HD	7.19

Type: AN - Zinc-Plated, STD - Galvanized Standard, HD - Hot Deep Galvanized

## WIRE ROPE CLIPS

Model No.	For Cable Dia."	Price /Each	Model No.	For Cable Dia."	Price /Each
LB007	1/8	0.40	LB012	1/2	3.29
LB008	3/16	0.60	LB013	5/8	5.09
LB009	1/4	1.09	LB014	3/4	6.09
LB010	5/16	1.25	LB015	7/8	9.89
LB011	3/8	1.89			

DROP-FORGED GALVANIZED					
LB016	1/8	1.34	LB020	3/8	4.49
LB017	3/16	1.69	LB021	1/2	6.79
LB018	1/4	2.09	LB022	5/8	9.69
LB019	5/16	2.99	LB023	3/4	12.90

## WIRE ROPE LIFTING SLING

### EYE & EYE GALVANIZED

- Made of 6x26 IWRC EIPS galvanized wire rope
- Solid identification tags on each sling

Model No.	Wire Diameter"	Length'	Vertical Capacity lbs.	Price /Each
LV024	1/4	4	1300	18.06
LV025	1/4	6	1300	20.50
LV026	1/4	8	1300	23.60
LV027	1/4	10	1300	26.10
LV028	1/4	12	1300	29.30
LV029	3/8	4	2800	25.70
LV030	3/8	6	2800	29.30
LV031	3/8	8	2800	33.10
LV032	3/8	10	2800	36.60
LV033	3/8	12	2800	40.40

## AUTO STAND TRAILER STABILIZING JACKS

- Heavy gauge steel construction
- Large base pad (17" x 18 1/2")
- Gas activated, self levelling system
- 10" dia. semi-pneumatic rubber tires for easy handling
- 41"-50.5" height range
- Large trailer contact pad
- Capacity: 100 000 lbs.
- **Only one required per trailer**

Model No. KH791  
Price/Each \$1375.00



## TRAILER STABILIZING JACKS

- Keeps tractorless trailers leveled while being loaded or unloaded
- Prevents accidents if wheel support collapses
- Stabilizes vehicle against load shifts
- Lowered height: 39 1/2"
- Raised height: 51"
- Removeable 37 1/2" positioning and ratcheting handle
- 8" dia support pad
- 8" wheels
- 100 000 lbs. supporting capacity each and 40 000 lbs lifting capacity
- **1 year warranty**
- **Recommended use in pairs**

Model No. KH777  
Price/Each: \$655.00



## AUTO STAND PLUS

- Heavy gauge steel construction
- Gas activated, self-levelling system
- Ergonomic lever action to safely pin, removing the need to bend over
- 16" dia. semi-pneumatic wheels allow for easy outdoor manoeuvring
- Large base pad: 17" x 18 1/2"
- Large trailer contact pad
- Capacity: 100 000 lbs.
- **Only one required per trailer**

Model No. ML786  
Price/Each \$1695.00



## ALUMINUM DECKING/SHORING BEAMS

- For 96" and 102" trailers
- Made from extruded high strength aluminum
- Designed to give maximum strength at the least possible weight
- Keyhole slot allows the beams to be hung and stored in the trailer out of the way when they are not in use
- Decking/Vertical Rating: 2000 lbs. uniformly distributed working load limit
- Head assemblies are all steel, zinc-plated and tapered for ease of operation
- Shoring/Horizontal Rating: 2000 lbs. uniformly distributed working load limit
- Comes standard with Kinedyne's patented "Kwik Latch" beam head release mechanism, for safe and quick beam deployment

**Note:** Working load limits are 1/3 of the ultimate breaking strength.

Model No. ND360  
Mfg. No. FE8066-3  
Price/Each \$145.00



## SAF-T-LOK BARS

- Designed for economy and ease of operation
- Constructed with high strength industrial round tubing
- Easy to close and lock with its heavy-duty steel rack, handle and cast aluminum housing
- Replaceable molded pivoting rubber feet, 2" x 4" that grip firmly to trailer walls
- Easy to open trigger release
- Adjusts from 90° to 105°
- Optional cargo hoop set, two hoops, which bolts quickly and easily to provide greater area of holding surfaces (installation hardware included)
- Available in either steel or aluminum versions
- Extra long steel version is available upon request



KH575



KH574



Model No.	Mfg. No.	Description	Wt. lbs.	Price /Each
ND698	10085	Steel Saf-T-Lok Bar	11.4	52.20
KH574	10088	Aluminum Saf-T-Lok Bar	17	69.50
KH575	10096	Cargo Hoop Set	15	135.00

## LOGISTIC TRACKS

### SERIES E TRACK HORIZONTAL

- Material: High strength 12-gauge steel
- Minimum Yield: 43 000 PSI
- Finished: Galvanized
- Weight: 16.2 lb.
- Length: 10 ft.

Model No. ND359  
Mfg. No. 43 001  
Price/Each \$109.00

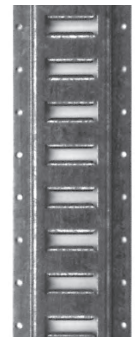
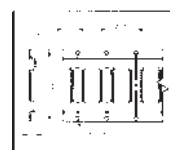

**Warning:**  
Welding galvanized material may form toxic fumes.  
Welding should be done with adequate ventilation.

## EXTRUDED RUBBER DOCK FENDERS

### D-4 DOCK FENDERS

- Guard against damaging impact
- Made of age, weather and abrasion-resistant synthetic rubber
- Easy to install and the trim appearance makes them well suited for use on trucks and truck docks
- Half oval shape allows radius to widen upon impact creating better deflection
- Easily installed manually or by power tools
- Hardware is concealed when installation is complete

**Note:** All given dimensions are nominal and may vary an average of 5% in manufacturing process.

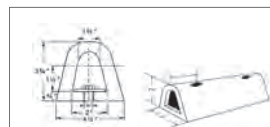

Diagonal



Horizontal



Vertical

### MOUNTING D-4 DOCK FENDERS

On Wood: Use 1/2" Lag Screws

On Concrete: Use 1/2" Self-Drilling Fasteners

On Steel: Weld 1/2" Studs on Centers as Required

In all cases, a drilled metal bar 3/16" x 1 1/2" should be inserted in the bore of the fender to act as a continuous washer.

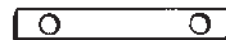

Mounting Bar



Dimensions				Anchor Holes	Approx. Wt. lbs.	Fender Drilled		Mounting Bar Drilled	
W"	x	H"	x			L"	Model No.	Price /Each	Model No.
4 1/2	x	3 3/4	x	12	2 req., 6"*	KH658	44.50	KH662	11.90
4 1/2	x	3 3/4	x	18	2 req., 12"*	KH659	66.50	KH663	17.50
4 1/2	x	3 3/4	x	24	2 req., 18"*	KH660	79.90	KH664	20.90
4 1/2	x	3 3/4	x	36	3 req., 15"*	KH661	109.00	KH665	27.90

\* Between holes



# DOCK EQUIPMENT

## STEEL-FACED LAMINATED RUBBER DOCK BUMPERS

- One of the strongest forms of loading dock protection
- Used in docking areas where excessive friction from up and down movement occurs, air-ride trailers, yard jockeys, etc.
- 3/8" thick, heavy duty, high carbon, "floating" steel face plate withstands abrasive friction of air-ride trailers
- Enclosed design prolongs rubber life
- **3-year warranty**



Model No.	A"	Dimensions			Wt. lbs.	Price /Each
		B"	C"	D"		
<b>4" PROJECTION</b>						
<b>HORIZONTAL STYLE</b>						
KH705	4	12	14	7	58	279.00
KH706	4	12	18	7	72	305.00
KH707	4	12	24	7	90	469.00
KH708	4	12	36	7	145	555.00
<b>VERTICAL STYLE</b>						
KH709	4	20	11	7 1/2	75	339.00
KH710	4	24	11	9 1/2	90	405.00
<b>6" PROJECTION</b>						
<b>HORIZONTAL STYLE</b>						
KH712	6	12	14	7	62	349.00
KH713	6	12	18	7	78	455.00
KH714	6	12	24	7	105	579.00
KH715	6	12	36	7	166	805.00
<b>VERTICAL STYLE</b>						
KH716	6	20	11	7 1/2	83	425.00
KH717	6	24	11	9 1/2	100	555.00

## SELECTING THE PROPER SIZE OF DOCK BUMPER

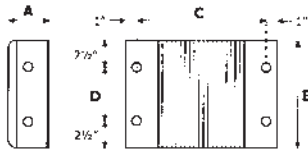

Horizontal Style —  
Laminated or Steel-Faced

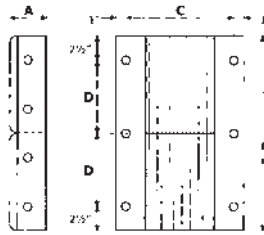

Vertical Style —  
Laminated or Steel-Faced

## SUPER HEAVY-DUTY TRUCK RAMP

- Long retractable handle eases movement and stores easily out of the way
- Suitable for large truck tires up to 16" maximum width
- Comes with rubber non-skid pad to prevent slippage
- 20 Ton capacity per pair
- Capacity: 40000 lbs.



**STRONGARM®**

Model No.	Mfg. No.	Overall Width"	Overall Length'	Usable Width"	Price /Each
UAV876	030481	9-1/4	5	18-1/4	1419.00

## LAMINATED RUBBER DOCK BUMPERS

- Unlimited applications in factories, warehouses and docks
- Ideal for projecting above low docks, rub rails against walls, marine dock protection
- Greater longevity of bumpers is achieved because rubber laminates are manufactured from reclaimed truck tires
- Manufactured under pressure exceeding 1500 lbs. to absorb over 80% of the impact
- **1-year warranty**



Model No.	A"	Dimensions			Wt. lbs.	Price /Each
		B"	C"	D"		
<b>4" PROJECTION</b>						
<b>HORIZONTAL STYLE</b>						
KH719	4	10	12	5	25	115.00
KH720	4	12	12	7	31	145.00
KH721	4	12	14	7	35	159.00
KH722	4	12	18	7	44	209.00
KH723	4	12	24	7	58	249.00
KH724	4	12	36	7	84	365.00
<b>VERTICAL STYLE</b>						
KH725	4	20	11	7 1/2	46	185.00
KH726	4	24	11	9 1/2	56	235.00
<b>6" PROJECTION</b>						
<b>HORIZONTAL STYLE</b>						
KH729	6	10	12	5	29	155.00
KH730	6	12	12	7	34	189.00
KH731	6	12	14	7	39	199.00
KH732	6	12	18	7	50	249.00
KH733	6	12	24	7	72	325.00
KH734	6	12	36	7	105	535.00
<b>VERTICAL STYLE</b>						
KH735	6	20	11	7 1/2	53	259.00
KH736	6	24	11	9 1/2	64	315.00
<b>9" PROJECTION</b>						
<b>HORIZONTAL STYLE</b>						
KH739	9	12	12	7	75	345.00
KH740	9	12	14	7	81	375.00
KH741	9	12	18	7	92	439.00
KH742	9	12	24	7	118	509.00
KH743	9	12	36	7	130	595.00
<b>VERTICAL STYLE</b>						
KH744	9	20	11	7 1/2	105	559.00
KH745	9	24	11	9 1/2	124	615.00

## MOLDED DOCK BUMPERS

- Protects building and dock areas
- Shockproof, tear and freeze resistant

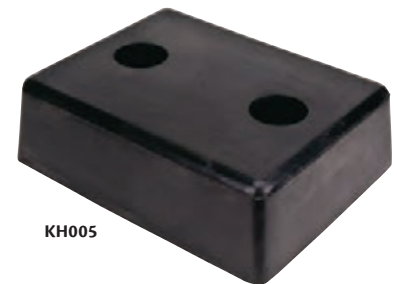

KH005

**KLETON**

Model No.	Material	Face size W" x H"	Overall Projection"	Wt. lbs.	Price /Each
KH005	Rubber	13 x 10	4	16	51.50
KH009	Rubber	18 x 10	4	32	76.95

## ALUMINUM DOCKPLATES

Skid resistant safety tread deck. Bevelled edges allow smooth access from either end. Bend at upper end permits both ends of plate to lie flat. Steel legs fit between dock and truck; prevent movement when in use. High tensile aluminum alloy construction; no welds to break.



### HOW TO ORDER:

1. **Select dockplate width:** add 12" to width of equipment to be used on dockplate.
2. **Determine height differential:** (the vertical distance from dock floor to truck floor) The height differential decides the necessary plate length.
3. **Select the necessary capacity.**

#### Above Dock Level



#### Below Dock Level



## COMBINATION BOARDS

For a height differential exceeding 11", use a ramp in combination with dockplate. Each plate can be converted to an equivalent-size ramp. Call us with your requirements.



Size W" x L" x H"	Height Diff."	Light Duty - 1/4" ga.				Regular Duty - 3/8" ga.				Heavy Duty - 1/2" ga.				Extra Heavy Duty - 5/8" ga.			
		Model No.	Cap. lbs.	Wt. lbs.	Price /Each	Model No.	Cap. lbs.	Wt. lbs.	Price /Each	Model No.	Cap. lbs.	Wt. lbs.	Price /Each	Model No.	Cap. lbs.	Wt. lbs.	Price /Each
36 x 48 x 9	7	KH206	700	53	655.00	KH148	1700	71	809.00	KH193	3000	97	995.00	-	-	-	-
42 x 48 x 9	7	KH207	800	60	719.00	KH153	2000	82	899.00	KH194	3500	110	1115.00	-	-	-	-
48 x 24 x 5	3	KH208	1800	36	519.00	KH154	4500	48	625.00	-	-	-	-	-	-	-	-
48 x 30 x 6	4	KH209	1450	44	585.00	KH155	3600	60	715.00	-	-	-	-	-	-	-	-
48 x 36 x 7	5	KH210	1250	52	649.00	KH156	3000	70	809.00	KH195	5400	94	995.00	-	-	-	-
48 x 42 x 8	6	KH211	1050	60	715.00	KH157	2600	82	899.00	KH196	4600	110	1115.00	-	-	-	-
48 x 48 x 9	7	KH212	900	67	769.00	KH158	2200	92	989.00	KH197	4000	124	1235.00	-	-	-	-
48 x 54 x 10	8	KH213	760	76	849.00	-	-	-	-	-	-	-	-	-	-	-	-
48 x 60 x 11	9	KH214	600	83	915.00	KH159	1500	114	1175.00	KH198	2700	155	1479.00	-	-	-	-
48 x 72 x 13	11	KH215	400	100	1045.00	KH160	1100	136	1355.00	KH199	2000	184	1839.00	-	-	-	-
60 x 24 x 5	3	KH216	2200	43	585.00	KH170	5600	59	715.00	KH200	10000	79	869.00	KH328	15600	98	1249.00
60 x 30 x 6	4	KH217	1800	54	669.00	-	-	-	-	-	-	-	-	-	-	-	-
60 x 36 x 7	5	KH218	1500	63	749.00	KH171	3700	86	945.00	KH201	6700	114	1169.00	KH329	10500	141	1675.00
60 x 42 x 8	6	KH219	1300	73	829.00	-	-	-	-	-	-	-	-	-	-	-	-
60 x 48 x 9	7	KH220	1100	83	915.00	KH172	2800	113	1169.00	KH202	5000	151	1595.00	KH330	7800	186	2109.00
60 x 60 x 11	9	KH221	880	102	1075.00	KH173	2200	140	1519.00	-	-	-	-	-	-	-	-
72 x 24 x 5	3	KH222	2600	51	649.00	KH174	6700	76	805.00	KH203	12000	94	989.00	KH331	18700	115	1535.00
72 x 30 x 6	4	KH223	1950	63	749.00	-	-	-	-	-	-	-	-	-	-	-	-
72 x 36 x 7	5	KH224	1650	74	845.00	KH175	4500	105	1079.00	KH204	8000	135	1469.00	KH332	12600	166	2105.00
72 x 48 x 9	7	KH225	1300	97	1045.00	KH176	3300	135	2259.00	KH205	6000	178	1835.00	KH333	9400	220	2675.00
72 x 60 x 11	9	KH226	900	121	1355.00	-	-	-	-	-	-	-	-	-	-	-	-

All Prices F.O.B. Weston, Ontario and items are non-returnable.

## ALUMINUM DOCKBOARDS

Ideal for truck or rail applications. Curb design adds strength and prevents equipment run-off. Skid resistant safety tread deck. Bevelled edges allow smooth access from either end. Bend at upper end permits both ends of plate to lie flat. Steel legs fit between dock and truck or railcar, prevent movement when in use. High tensile aluminum alloy construction.

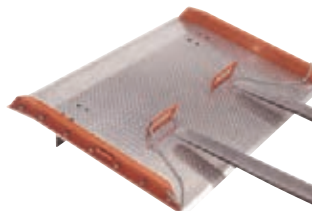

### OPTIONS: FORKLIFT HANDLES

Makes movement of heavy boards and plates easy and safe. Recommended for boards and plates over 140 lbs. Sold in pairs.

Model No. KH191  
Price/Each \$195.00

### HOW TO ORDER:

1. Determine required capacity: 90% of gross weight for forklift trucks; 67% of gross weight for powered pallet trucks. Example: Wt. of Forklift + Wt. of Heaviest Load = Gross Weight x .90 = Required Capacity (5 500 lbs. + 10 000 lbs. = 15 500 x .90 = 13 500 lbs.)
2. Select dockboard width: add 12" to width of equipment to be used on dockboard.
3. Determine height differential (the vertical distance from dock floor to truck floor).

## FABRICATED ALUMINUM HOSE & CABLE CROSSOVERS

- Protects hoses and cables from carts and other forms of traffic
- Constructed of light weight durable aluminum tread plate
- All welded
- Capacity: 2000 lbs. (1 tons)
- No. of Channels: 1
- 48.03" L x 24" W x 4.5" H

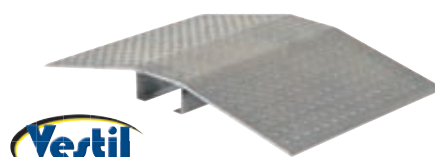

Model No.	Channel Width"	Channel Height"	Weight lbs.	Price /Each
XI022	16.03	4.09	90	869.00

Model No.	Width Cap. lbs.	Width Inside Curbs"	Overall Width"	Overall Length"	Height Diff."	Wt. lbs.	Price /Each
KH149	4000	51	54	60	9	164	1869.00
KH150	4000	51	54	72	11	210	2229.00
KH151	4000	57	60	60	9	177	1979.00
KH152	4000	57	60	72	11	225	2229.00
KH161	6000	51	54	48	7	143	1645.00
KH162	6000	50	54	60	9	177	1885.00
KH163	6000	50	54	72	11	225	2419.00
KH164	6000	57	60	48	7	153	1735.00
KH165	6000	56	60	72	11	240	2249.00
KH166	6000	63	66	36	5	123	1739.00
KH167	6000	63	66	48	7	163	1825.00
KH168	6000	62	66	60	9	203	2109.00
KH169	6000	69	72	48	7	174	1915.00
KH177	8000	51	54	36	5	106	1419.00
KH178	8000	50	54	48	7	149	1659.00
KH179	8000	50	54	60	9	188	2145.00
KH180	8000	50	54	72	11	236	2679.00
KH181	8000	57	60	36	5	115	1489.00
KH182	8000	56	60	48	7	160	1749.00
KH183	8000	56	60	60	9	201	1999.00
KH184	8000	56	60	72	11	251	2509.00
KH185	8000	69	72	30	4	110	1649.00
KH186	8000	68	72	48	7	181	1929.00
KH187	8000	68	72	60	9	227	2225.00
KH188	8000	68	72	72	11	282	3189.00
KH189	8000	68	72	84	13	340	3555.00
KH105	10000	51	54	36	5	127	1615.00
KH106	10000	50	54	48	7	176	1919.00
KH107	10000	50	54	60	9	222	2469.00
KH108	10000	50	54	72	11	276	3169.00
KH109	10000	56	60	60	9	239	2359.00
KH110	10000	56	60	72	11	297	2945.00
KH111	10000	63	66	36	5	148	2039.00
KH112	10000	62	66	48	7	197	2159.00

All Prices F.O.B. Weston, Ontario and items are non-returnable.

# DOCK EQUIPMENT

## SOFT EDGE FLEXIBLE WARNING & PROTECTION SYSTEMS

- Tough, flexible polyurethane foam extrusions reduce the risk of personnel injury at high risk corners
- When applied to machinery, furnishings and walls, Soft Edge prevents impact damages by absorbing even the hardest of impacts
- Highly visible black and yellow markings offer permanent warning in dangerous areas
- Simple "peel-away" adhesive installation on grease-free surfaces
- Excellent temperature range from -40°C to 100°C

**Knuffi**

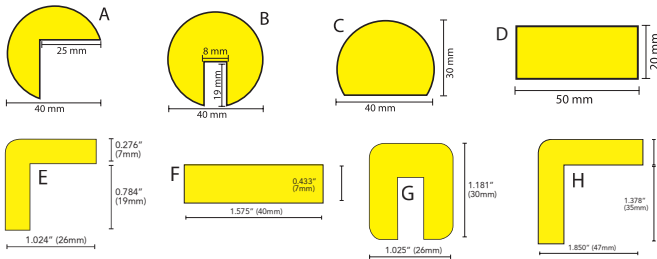

Style	1 Metre Model No.	Price /Each	5 Metres Model No.	Price /Each
A	KH866	44.50	KH865	235.00
B*	KH868	46.50	KH867	245.00
C	KH870	46.90	KH869	249.00
D	KH872	60.90	KH871	319.00
E	KH952	46.90	KH953	249.00
F	KH954	44.90	KH955	239.00
G*	KH956	48.50	KH957	255.00
H	KH958	63.90	KH959	335.00

\* Does not have peel-away adhesive. Held by pressure fit.

## CORNER PROTECTORS

- Corner Protectors help prevent damage to walls in areas with forklifts, hand trucks and other warehousing traffic
- These guards are high-visibility yellow
- Made with high density polyethylene (HDPE)
- Crack and chip resistant
- Feature unique energy absorbing construction
- Anchors not included
- Can be mounted end to end
- **Sold in sets of 2 protectors**
- Material: Polyethylene



Sold per Set

Model No.	Dimensions L" x W" x H"	Wt. lbs.	Price /Each
KH994	10 x 6 x 21	10	229.00
KH995	10 x 6 x 42	20	359.00

## WALL PROTECTORS

- Wall Protectors help prevent damage to walls in areas with forklifts, hand trucks and other warehousing traffic
- These guards are high-visibility yellow
- Made with high density polyethylene (HDPE)
- Crack and chip resistant
- Feature unique energy absorbing construction
- Anchors not included
- Can be mounted end to end
- **Sold in sets of 2 protectors**
- Material: Polyethylene



Sold per Set

Model No.	Dimensions L" x W" x H"	Wt. lbs.	Price /Each
KH996	42 x 2 x 6	8	275.00
KH997	42 x 2 x 10	14	305.00

## SAFETY GUARDS

- Protect your equipment and personnel from accidental damage and injury with these low profile safety guards
- 4" x 4" square tube welded to an 8" x 8" x 1/2" base, complete with four 3/4" diameter holes for anchoring to floor
- Safety Yellow Powder Coat Finish

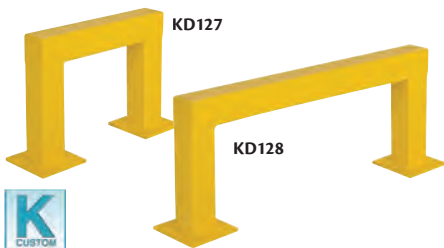

Model No.	Dimensions L" x H"	Wt. lbs.	Price /Each
KD127	24 x 18	65	419.00
KH855	36 x 18	75	515.00
KD128	48 x 18	85	485.00
KD136	24 x 42	95	545.00
KD139	48 x 42	115	599.00

## UPRIGHT PROTECTORS

- Protects industrial racking from damaging impacts that cause unsafe conditions
- Made from 1/4" thick steel
- 4 pre-drilled holes made for 1/2" anchors (not included)
- Safety Yellow Powder Coat Finish



Model No.	O.A. Dimensions W" x D" x H"	Wt. lbs.	Price /Each
KH858	7 x 7 x 12	12	46.95
RB925	7 x 7 x 18 1/4	15	63.95

## HEAVY-DUTY STEEL BOLLARDS

- Protect your warehouse equipment, as well as high traffic areas with these heavy-duty steel bollards
- 4" x 4" square tube welded to an 8" x 8" x 1/2" steel base complete with four 3/4" diameter holes for anchoring to floor
- Safety Yellow Powder Coat Finish



Model No.	Height"	Wt. lbs.	Price /Each
KD125	24	30	179.00
KH857	36	40	209.00
KD126	48	50	215.00





## SLOWSTOP® FLEXIBLE REBOUNDBING BOLLARD

- Protect buildings, assets, vehicles, and pedestrians from damaging collisions with this incredibly strong surface mounted bollard that absorbs energy from impacts then rebounds back to its original position without damage
- Includes all necessary installation pieces
- 60µm hot-dipped galvanized & 60µm polyester outdoor powder coatings

### 4" DIAMETER BOLLARDS

- Ideal for medium applications such as cars, light trucks, and typical fork lifts
- Stops 5000 pounds at 3.4 mph without damage

### 6" DIAMETER BOLLARDS

- Perfect for heavy applications such as delivery trucks, heavy fork lifts, and even semi-trailers
- Stops 5000 pounds at 7.5 mph without damage

### DRILLED BOLLARDS

- Features mounting holes and plugs that can be used to attach guardrails



Model No.	Mfg. No.	Type	Dia."	Height"	Price /Each
MP184	60-5201-A	Standard	4	42	1079.00
MP185	60-5203-A	Standard	6	42	2515.00
MP186	60-5261-A	Drilled	4	42	1145.00
MP187	60-5263-A	Drilled	6	42	2410.00

## PROGUARDS TEMPORARY GUARD RAIL POSTS

- Allows you to quickly and easily create fully compliant guardrails that provide the required fall protection from the unsafe areas of the job site
- Connect 2x4 rails to the supplied posts
- Dual hooks allow for 90° installs and angled stair rails and handrails
- Width: 8"
- Height: 39"
- Colour: Orange
- Qty/Box: 2 Posts
- Hook Height: 3.5"
- Hook Depth: 1.5"
- No. of Screw Holes: 8

Model No. MP191  
Mfg. No. 70-8010  
Price/Box \$295.00



## SLOWSTOP® FLEXRAIL GUARD RAIL

- Mount to SlowStop® Rebounding Bollards for increased strength and system durability
- Overall Height: 13-3/4"
- Material: Polycarbonate
- Break Strength: 24832 lbf / 110 kN
- Maximum Deflection: 21" / 56 cm



### END CAPS

- Attaches to sections of SlowStop® FlexRail to provide an end impact zone in the most likely direction of travel
- Female: Attaches to recessed side of FlexRail guard rail
- Male: Attaches to straight ends of FlexRail guard rail



MP188



MP189



MP190

Model No.	Mfg. No.	Type	Overall Length"	Price /Each
MP188	60-5250	Rail	157-1/2	986.00
MP189	60-5256	End Cap – Female	9-4/5	345.00
MP190	60-5257	End Cap – Male	9-4/5	345.00

## SPRING LOADED BOLLARD

- Designed to serve as a visual warning to personnel
- 30° spring-loaded design will bend and not break like rigid bollards
- Overall Length: 2-1/8"
- Overall Width: 2-1/8"
- Overall Height: 42"
- Colour: Yellow
- Material: Steel

Model No. MP197  
Mfg. No. SPBOL-42  
Price/Each \$185.00



## TOOLS THAT MEASURE UP!



# DOCK EQUIPMENT

## HOW TO CHOOSE A CABLE PROTECTOR

### WHY USE CABLE PROTECTORS

- Protect your cables, cords, and hose lines from pedestrian traffic, vehicle and heavy-duty equipment movement
- Ideal for festivals, construction sites, conventions centers, and any event or facility
- Cost-effective solution helps prevent damage caused by wire vibration, contact with other heat producing equipment or simply from tripping
- Improve accessibility
- Cable protectors are offered in a variety of size, material and colour to suit all types of applications.



## WHAT TO CONSIDER

### 1. SIZE – HOW MANY CABLES DO YOU WANT TO PROTECT?

- Protect 1,2,3,4, and 5 cables using the same protector, each slot is known as a "Channel"

#### What you need to know

- Know the overall diameter of your cables: Make sure that your cables will fit into the cable protector by choosing the proper channel width and height

#### General Rule to Remember

- Remember that as the number of channels on the protector decreases, the channel height will increase

#### Is your vehicle clearance height limited?

- Low profile and drop-over models are a quick solution to protect your cables while allowing low vehicle, pedestrian walking, and handicap access



### 2. LOAD CAPACITY - WHAT WILL BE CROSSING OVER THE CABLE PROTECTOR?

- With capacities up to 800000 lbs. per axle (load that a vehicle will put on a cable protectors as they drive over them), cable protectors can withstand thousands of pounds and endure constant impact
- Heavy-duty cable protectors are ideal for vehicles or hauling trucks and light-duty cable protectors are best for light to heavy pedestrian walking, light commercial and utility applications



### 3. CONNECTOR TYPE - INTERLOCKING DESIGN FOR EASY SETUP AND DISASSEMBLE

- Connect multiple units together to create your desired length



### 4. ACCESSIBILITY RAMPS & RAILS

- Most of Checkers® Cable Protectors offer ADA/DDA compliant access ramp



### 5. MATERIAL

#### Polyurethane:

- Heavy-duty to general purpose applications
- Ideal for heavy-duty equipment and high volume traffic
- Oil gas, mining, military, construction, entertainment, manufacturing, and material handling
- Light weight and more durable
- Withstand extreme weather conditions

#### Rubber:

- Light-duty applications
- Ideal for pedestrian traffic and light vehicle traffic
- Office, light industrial, entertainment

### 6. COLOURS

- Universal safety colours are available for all types of traffic
- High Visibility Colours Include: Yellow, Orange, Black, and Blue



### 7. NEED ACCESSORIES?

- Adding accessories to your cable protectors depends widely on placement and positioning of your cable protector system. Most cable protector series offer accessories such as: End caps, 45 degree left and/or right turns, 4 and 3-way cross intersections



## LINEBACKER® CABLE PROTECTORS

- Most robust cable protection option
- High load bearing capacity for heavy equipment applications
- Ideal for: Manufacturing, Oil and gas, mining, military, construction and heavy-duty applications
- Protects cables and hoses
- All-weather polyurethane construction
- Easy to transport, setup, disassemble, and store
- Thick lid and base allow for high volume of traffic
- Modular interlocking design



Model No.	Mfg. No.	No. of Channels	Dimensions			Channel W" x H"	Max. Load Capacity lbs./tons		Price /Each
			W"	L"	H"		Tire	Axle	
KH702	CP1X125-GP-0	1	11.5	36	1.625	1.25 x 1.25	11 700/11.7	23 400/5.85	479.00
KH699	CP2X325-Y/0	2	22	36	4.13	3.25 x 3.25	10 880/5.44	21 760/10.88	1315.00
KH695	CP3X225-Y/0	3	20	36	3.05	2.25 x 2.25	14 210/7.105	28 400/14.21	1025.00
KH691	CP4X125-Y/0	4	20	36	2.31	1.85 x 1.35	20 150/10.075	40 300/20.15	849.00
KI046	CP4X300-Y/0	4	23.9	36	3.9	3 x 3	10 100/5.05	20 200/10.1	979.00
KH700	CP5X125-GP-O/Y	5	17.25	36	1.9375	1.3 x 1.3	10 500/5.25	21 000/10.5	615.00
KH687	CP5X125-Y/0	5	20	36	2.31	1.35 x 1.35	20 150/10.075	40 300/20.15	849.00

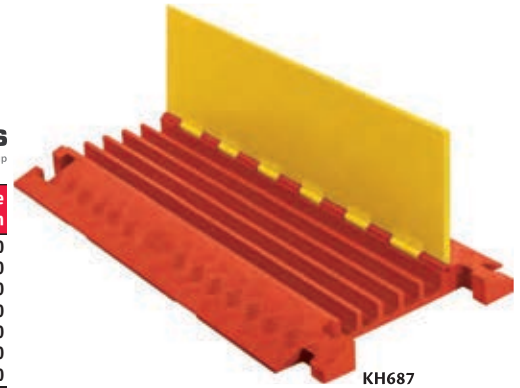

## GUARD DOG® LOW PROFILE CABLE PROTECTORS

- Protects cables and hoses
- Modular interlocking design
- Thick lid and base allow for high volume of traffic
- Easy to transport, setup, disassemble, and store
- Most versatile cable protection option
- Solid construction for pedestrian traffic, and over the road vehicles
- Ideal for: Utility, industrial, entertainment



Model No.	Mfg. No.	No. of Channels	ADA/DDA Access	Dimensions			Channel W" x H"	Max. Load Capacity lbs./tons		Price /Each
				W"	L"	H"		Tire	Axle	
KI120	GD1X75-ST-O/B	1	No	10.81	36	1.25	2.25 x 0.75	13 000/6.5	26 000/13	335.00
KI117	GD1X75-O/B	1	Yes	27.25	36	1.25	2.25 x 0.75	23 000/11.5	46 000/23	565.00
KI125	GD2X75-ST-O/B	2	No	11.94	36	1.25	1.5 x 0.75	13 000/6.5	26 000/13	385.00
KI122	GD2X75-O/B	2	Yes	28.38	36	1.25	1.5 x 0.75	23 000/11.5	46 000/23	615.00
KI136	GD3X75-ST-O/B	3	No	13.8	36	1.25	1.25 x 0.75	17 000/8.5	34 000/17	475.00
KI133	GD3X75-O/B	3	Yes	30.3	36	1.25	1.25 x 0.75	27 000/13.5	54 000/27	709.00
KI131	GD3X225-O/B	3	No	20	36	3	2.25 x 2.25	14 210/7.1	28 420/14.21	869.00
KI151	GDSX75-ST-O/B	5	No	16.9	36	1.25	1.28 x 0.75	24 000/12	48 000/24	515.00
KI148	GDSX75-O/B	5	Yes	33.3	36	1.25	1.28 x 0.75	34 000/17	68 000/34	825.00
KI146	GDSX125-O/B	5	No	19.75	36	1.875	1.339 x 1.325	10 500/5.25	21 000/10.5	569.00



## GRIP GUARD® LIGHT-DUTY CABLE PROTECTOR

- Made from tough, high impact absorbing, non-conductive polyurethane
- Resistant to oil, fuels and lubricants
- Recessed carrying handle molded in to the underside of the protector
- Super lightweight: Up to 75% lighter than standard cable protectors
- Ideal for: Entertainment, light commercial and utility applications



Model No.	Mfg. No.	No. of Channels	Dimensions			Channel W" x H"	Max. Load Capacity lbs./tons		Price /Each
			W"	L"	H"		Tire	Axle	
KH981	GG5X125-Y/GRY	5	16.4	36	1.6	1.25 x 1.25	5000/2.5	10 000/5	379.00
KH986	GG3X225-Y/GRY	3	18.2	36	2.67	2.25 x 2.25	5000/2.5	10 000/5	505.00



## FASTLANE® CABLE PROTECTOR

- Features drop-over design for quick cable set-up and disassembly
- Features patented 5-bar textured surface for maximum traction
- Ideal for lightweight vehicles and pedestrian traffic
- Features modular interlocking design
- Connector Type: L-connector
- Material: Polyurethane



Model No.	Mfg. No.	No. of Channels	Dimensions			Channel W" x H"	Max. Load Capacity lbs./tons		Colour	Price /Each
			W"	L"	H"		Tire	Axle		
KI099	FL1X1.5-B	1	5.25	36	0.75	1.5 x 0.5	1050/0.525	2100/1.05	Black	129.00
KI100	FL1X1.5-O	1	5.25	36	0.75	1.5 x 0.5	1050/0.525	2100/1.05	Orange	129.00
KI101	FL1X1.5-Y	1	5.25	36	0.75	1.5 x 0.5	1050/0.525	2100/1.05	Yellow	129.00
KI102	FL1X4-B	1	10.75	36	1.5	4 x 1	1050/0.525	2100/1.05	Black	239.00
KI103	FL1X4-O	1	10.75	36	1.5	4 x 1	1050/0.525	2100/1.05	Orange	239.00
KI104	FL1X4-Y	1	10.75	36	1.5	4 x 1	1050/0.525	2100/1.05	Yellow	239.00
KI105	FL2X1.75-B	2	10.75	36	1.5	1.75 x 1	1050/0.525	2100/1.05	Black	239.00
KI106	FL2X1.75-O	2	10.75	36	1.5	1.75 x 1	1050/0.525	2100/1.05	Orange	239.00
KI107	FL2X1.75-Y	2	27.25	36	1.5	1.75 x 1	1050/0.525	2100/1.05	Yellow	239.00

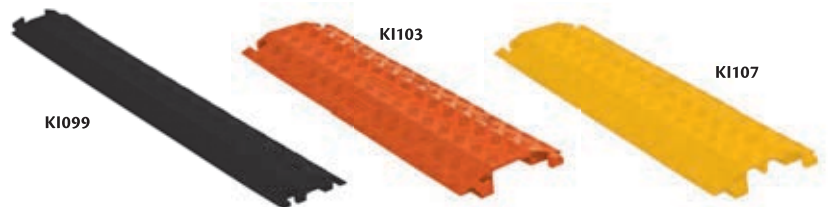



# DOCK EQUIPMENT

## FABRICATED ALUMINUM HOSE & CABLE CROSSOVERS

- Protects hoses and cables from carts and other forms of traffic
- Constructed of light weight durable aluminum tread plate
- All welded
- Capacity: 2000 lbs. (1 tons)
- No. of Channels: 1

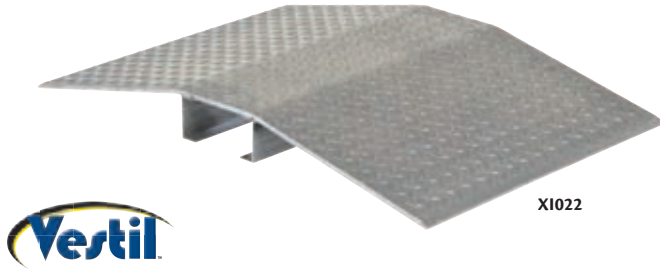

Model No.	Length"	Width"	Height"	Channel Width"	Channel Height"	Weight lbs.	Price /Each
XI022	48.03	24	4.5	16.03	4.09	90	869.00

## DOCK LOADING LIGHTS WITH FLEXIBLE ARM

- Rubber enclosed shock absorber allows arm to deflect if struck by doors or lift trucks
- Durable design and construction reduces maintenance costs
- Includes: Lamp cover
- Certified for sale in Canada by an accredited certification body

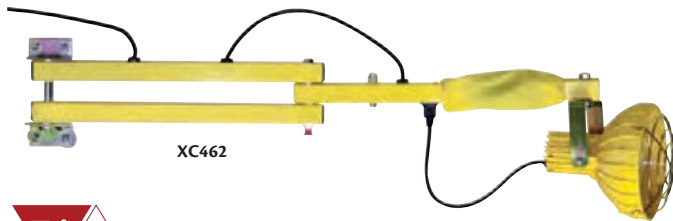

Model No.	Extended Arm Length"	Head Type	Wt. lbs.	Price /Each
XC455	40	Metal	17	465.00
XC461	60	Metal	21	499.00
XC462	40	Polycarbonate	16	415.00
XC463	60	Polycarbonate	20	475.00

## DOCK LIGHTS

- Built-in on-off switch
- Durable stainless steel cage for better protection of the light
- Bracket mounted for easy installation
- Arm sections are adjustable in all directions
- Features an adjustable screw to help direct the light where you need it
- Ideal for use in shipping/receiving docks, work lighting, spot lighting, and other similar applications

Model No.	Extended Arm Length"	Lamp Type	Wattage	Head Type	Lumens	Price /Each
XI316	40	LED	50 W	Metal	5500	278.00

## ULTRA-SIDEWINDER® CABLE PROTECTION SYSTEM

- Innovative new solution for protecting cables that run across a floor
- Design articulates left and right - allowing the system to turn corners and adapt to the layout of the room
- Simple "snap in" assembly - no tools or cutting required
- Fully customizable lengths available in 3 or 1 foot sections
- Black and yellow colour provides additional safety visual warning



Model No.	Description	Capacity lbs.	Dimensions L" x W" x H"	Channel Width"	Channel Height"	Minimum Radius"	End Caps	Price /Each
MN716	Small	32000	39 1/2 x 3 x 3/4	3/4	3/8	10.5	Included	71.90
MN717	Small	32000	13 1/8 x 3 x 3/4	3/4	3/8	10.5	Not Included	26.50
MN718	Medium	13500	33 x 9 3/4 x 1 3/8	3	3/4	24	Included	239.00
MN719	Medium	13500	14 1/8 x 9 3/4 x 1 3/8	3	3/4	24	Not Included	84.50
MN720	Large	13500	34 x 13 5/8 x 2 1/8	3	1 1/2	33	Included	325.00
MN721	Large	13500	14 1/8 x 13 5/8 x 2 1/8	3	1 1/2	33	Not Included	115.00

## PALLET BUSTERS

- Get rid of broken or unsightly pallets quickly and safely
- Unique dual prying action with nail puller
- Also can be utilized for dock board removal
- Overall Dim.: 45-1/8" L x 6-1/2" W x 7-1/8" D
- Handle Diameter: 1-1/4"
- Colour: Blue

Model No. MO015  
Mfg. No. SKB-DLX  
Price/Each \$119.00



## LED LOADING DOCK LIGHTS

### HEAVY-DUTY

- Rugged cast aluminum housing with LEDs built-in to the dock light housing
- Uses only 18 watts of energy
- Provides more light than a 300-watt spot light
- Ideal for food service industries or refrigerated warehouses
- LED light head is completely sealed with a shatterproof polycarbonate lens
- No fragile filament or glass parts to break
- On/off switch and strain relief located in the recessed back plate
- Rated for wet locations IP66, NEMA4
- All LED models have an average life of 60000 hours
- Certified for sale in Canada by an accredited certification body
- **5-year warranty**



Model No.	Arm Length"	Wt. lbs.	Price /Each
<b>ADJUSTABLE SINGLE STRUT</b>			
XC696	24	18	729.00
XC697	40	20	755.00
XC698	60	23	779.00
<b>DOUBLE STRUT</b>			
XC692	24	18	755.00
XC693	40	21	765.00
XC694	60	25	789.00
XC695	90	34	975.00
<b>ADJUSTABLE DOUBLE STRUT</b>			
XC699	40	26	765.00
XC700	60	36	1169.00
XD023	H.D. LED head only	8	599.00

### METAL OR POLYCARBONATE SERIES

- LED emits white light cool to the touch
- Uses only 14 watts of energy
- Provides the equivalent of a 150-watt incandescent bulb
- LEDs are built-in to the dock light housing; more durable than screw in type fixtures
- All LED models have an average life of 60000 hours
- Certified for sale in Canada by an accredited certification body
- **5-year warranty**



Model No.	Arm Length"	Head Type	Wt. lbs.	Price /Each
<b>ADJUSTABLE SINGLE STRUT</b>				
XD024	24	Metal	15	609.00
XD025	40	Metal	18	619.00
XD026	60	Metal	21	649.00
XD027	24	Polycarbonate	15	509.00
XD028	40	Polycarbonate	17	525.00
XD029	60	Polycarbonate	20	565.00
<b>DOUBLE STRUT</b>				
XD030	24	Metal	16	639.00
XD031	40	Metal	18	649.00
XD032	60	Metal	23	659.00
XD033	24	Polycarbonate	15	525.00
XD034	40	Polycarbonate	17	549.00
XD035	60	Polycarbonate	22	439.00
<b>ADJUSTABLE DOUBLE STRUT</b>				
XD036	40	Metal	23	645.00
XD037	60	Metal	33	675.00
XD038	40	Polycarbonate	23	545.00
XD039	60	Polycarbonate	33	599.00
<b>ACCESSORIES</b>				
XD041	Metal LED modular, lamp head only		6	529.00
XD042	Polycarbonate LED modular, lamp head only		5	435.00

## LOADING DOCK LIGHTS

- The adjustable models allow flexible horizontal and vertical positioning
- 1 1/2", 14-gauge square steel tubing
- Two-piece wall bracket assures secure mounting
- Available with either metal head or with a "cool to the touch" polycarbonate head that will not dent or break
- Comes with wire lamp guard
- Suitable for PAR-38 LED lamps
- Certified for sale in Canada by an accredited certification body

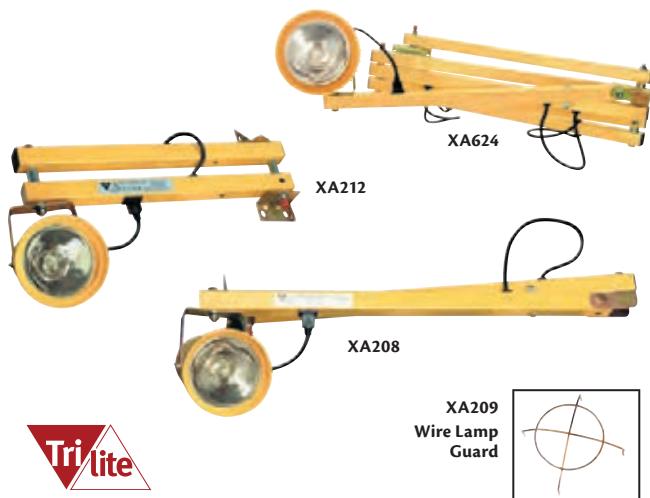

Model No.	Arm Length"	Head Type	Wt. lbs.	Price/Each
<b>ADJUSTABLE SINGLE STRUT</b>				
XA213	40	Metal	16	275.00
XA208	60	Metal	21	325.00
XC446	40	Polycarbonate	15	249.00
XC447	60	Polycarbonate	20	275.00
<b>DOUBLE STRUT - HORIZONTAL POSITIONING ONLY</b>				
XA212	24	Metal	16	285.00
XA211	40	Metal	18	309.00
XA214	60	Metal	23	339.00
XA349	90	Metal	35	559.00
XC448	24	Polycarbonate	15	249.00
XC449	40	Polycarbonate	17	259.00
XC450	60	Polycarbonate	22	285.00
XC451	90	Polycarbonate	34	499.00
<b>ADJUSTABLE DOUBLE STRUT</b>				
XA619	40	Metal	18	325.00
XA620	60	Metal	21	349.00
XA621	90	Metal	31	559.00
XA623	40	Polycarbonate	17	275.00
XA624	60	Polycarbonate	20	325.00
XA625	90	Polycarbonate	30	525.00
<b>ACCESSORIES</b>				
Model No.	Description			Price/Each
XA209	Replacement wire guard for metal head			35.50
XC731	Replacement wire guard for polycarbonate head			33.90
XD043	Replacement PAR-38 LED lamp			179.00
XC224	Replacement metal head			189.00
XC445	Replacement polycarbonate head			169.00

# DOCK EQUIPMENT

## LED STOP & GO LIGHTS

Loading Dock Stop & Go Light is a safety signaling device that alerts truck drivers and loading dock personnel to the safety status of docked or docking trucks.

- Simple, reliable and cost-effective warning system that reduces the risk of accidents around the loading dock
- Establishes a clear line of communication between drivers and dock personnel
- Safety yellow polypropylene housing will not rust, pit, dent or corrode
- Shallow depth of unit (less than most dock bumpers) prevents damage to the Stop & Go Light
- Integral eyebrow-type sun visors create extended visibility
- Mounting holes conform to standard building specifications
- Units can be used indoors or outdoors
- Dimensions: 6 3/8" W x 3 3/4" D x 11 3/8" H. Lens diameter: 4 1/4"
- Certified for sale in Canada by an accredited certification body
- Weight: 2 lbs. per single unit, 4 lbs. for the set

Uses 80% less energy

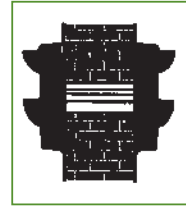

IDEAL FOR ANY VEHICLE, INDICATING HAZARDOUS AREAS OR PLANT CONTROL



12 VDC	Model No.		Description	Price /Each
	24 VDC	115 VAC		
XC100	XC101	XC102	Stop & Go – w/o flasher or switch	239.00
XC103	XC104	XC105	Stop & Go – w/flasher & switch	285.00
XC106	XC107	XC108	Stop & Go – Set, including one of each of the above	479.00

## TRAFFIC CONTROL SYSTEMS

The TCS 3000 Series outlines the docking area and makes backing up and spotting trailers easy. Safety is maintained through clear communication, while avoiding injury to personnel and costly damage to loading docks, equipment and buildings. The red and green LED lights are instantly understood as "Stop" and "Go", providing clear signals to dock attendants inside the building and truck drivers outside the building.



### APPLICATIONS

- Control entry to parking garages, loading dock areas and drive-thru or any high traffic areas
- Warn workers and drivers of hazardous situations

### FEATURES

- LEDs provide up to 100000 hours or 10 years of continuous use
- LEDs provide a high quality light with no glare
- Uses 30% less energy than conventional incandescent guide light units
- Recessed LED's are shock, vibration and temperature proof, and produce no heat
- Service/maintenance free, no need to replace bulbs or lenses
- Will not rust, pit or corrode

### SPECIFICATIONS

- Operating and storage temperatures range from -40°C to 85°C
- Embedded wiring on the back of the panel makes the lights moisture, water and weather resistant
- Each light fixture includes a 15' long wiring cable
- Pre-drilled mounting holes provide easy installation

Model No.	Mfg. No.	Description	Price /Each
XC796	60-5412-U	Indoor 12/24V	309.00
XC797	60-5411-U	Outdoor 12/24V	299.00
XC798	60-5412-110	Indoor 110/115/120V AC	425.00
XC799	60-5411-110	Outdoor 110/115/120V AC	319.00

### TCS 3000 SURE-DOCK

- Using the Sure-Dock system truck drivers can safely center their truck and/or trailer between the Sure-Dock panels
- Panels sold individually

Model No.	Mfg. No.	Description	Price /Each
XC800	60-5414-U	12 V/24 V	305.00
XC801	60-5414-110	110/115/120V AC, UL Approved	319.00

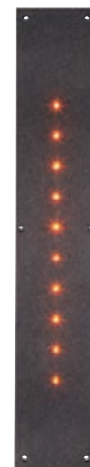

Sure-Dock

XC798 Interior



"Stop" and "Go" Light

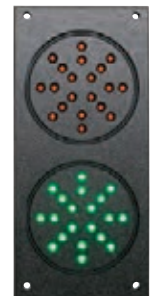

XC799 Exterior



## CASTER SELECTION GUIDE

### 4 FUNDAMENTAL FACTORS TO CONSIDER



#### REQUIRED LOAD CAPACITY

This is the most important criterion for caster selection. Each caster should have the capacity to support one-third of the total load weight, because overloading, uneven floors and load distribution may place a heavier burden on one or more casters.



#### MOBILITY NEEDS

The larger the wheel size (and swivel radius), the greater the mobility. The type of bearing selected will also improve mobility and reduce rolling resistance. Neoprene, elastomeric, and urethane wheels offer maximum mobility.



#### FLOOR CONDITIONS

What are your floors like? Check for rough or uneven surfaces—joints, grates, potholes—and for oil, grease and solvents or a variety of other chemicals or contaminants. In addition, note any carpeted areas or areas where non-marking qualities are critical.



#### ENVIRONMENTAL CONDITIONS

Check for dust, humidity and temperature extremes. Are the floors littered with debris? Casters with sealed swivels are ideal in areas with sprays or wash-down requirements where there is lint or dust and where extreme quiet is essential.

	Metal	Solid Rubber	Phenolic	Polyolefin	Hi-Temp Nylon	Blue Elastic Rubber	Polyurethane	Soft Rubber	Pneumatic	Semi-Pneumatic
<b>FLOOR SURFACES</b>										
Asphalt	Yes	No	No	No	No	Yes	Yes	Yes	Yes	Yes
Brick, ceramic tile	No	Yes	Yes	Yes	Yes	Yes	Yes	Yes	Yes	Yes
Concrete	Yes	Yes	Yes	Yes	Yes	Yes	Yes	Yes	Yes	Yes
Terrazzo	No	No	No	No	No	Yes	Yes	Yes	Yes	Yes
Steel-ribbed	No	Yes	No	Yes	Yes	Yes	Yes	Yes	Yes	Yes
Steel-smooth	Yes	Yes	Yes	Yes	Yes	Yes	Yes	Yes	Yes	Yes
Carpet	No	Yes	Yes	Yes	Yes	Yes	Yes	Yes	Yes	Yes
Linoleum, soft tiles	No	No	No	Yes	No	Yes	Yes	Yes	Yes	Yes
Wood, block, planks	Yes	No	Yes	No	No	Yes	Yes	Yes	Yes	Yes
<b>FLOOR CONDITIONS</b>										
Floor protection	No	Yes	Yes	Yes	Yes	Yes	Yes	Yes	Yes	Yes
Quiet operation	No	No	No	No	No	Yes	Yes	Yes	Yes	Yes
<b>ENVIRONMENTS</b>										
Oil grease	Yes	Yes	Yes	Yes	Yes	No	Yes	Yes	Yes	Yes
Mild chemicals	Yes	Yes	Yes	Yes	Yes	Yes	Yes	Yes	Yes	Yes
Water	No	Yes	Yes	Yes	Yes	Yes	Yes	Yes	Yes	Yes
Steam	No	Yes	Yes	Yes	Yes	Yes	No	Yes	Yes	Yes
Below -20°F	Yes	Yes	Yes	No	Yes	Yes	No	Yes	No	No
Above 160°F	Yes	No	Yes	Yes	Yes	No	Yes	No	No	No
Metal chips/shavings	Yes	No	No	No	No	Yes	Yes	No	No	No

#### WHEEL TYPES

**Soft Rubber:** Offers a smooth, semi-cushioned ride with good floor protection, but can leave black marks on floors. Wears on rough surfaces and can become brittle if left exposed to the elements. Standard colour is black.

**Hard Rubber:** Economical, easy rolling and durable wheel with adequate impact strength, hard rubber can hold more weight than soft rubber and doesn't mark the floor as easily.

**Mold-On Rubber:** Offers a semi-cushioned ride, rolls over debris and on uneven surfaces. Tread is soft black rubber that can mark. Performs well on lighter applications but doesn't handle overloading very well.

**Pneumatic:** Have an outer tire with an inflatable tube, mounted to a metal rim assembly. The inflatable tire offers an exceptional cushioned ride, is light weight and has a great diversity of applications. Limited weight capacity, punctures and marking rubber are disadvantages to consider.

**Semi-Pneumatic:** Natural black rubber tread on a polyolefin/plastic hub and come standard with ball bearings. These wheels are used in many of the same applications as the full pneumatic wheels, but have the advantage of not going flat.

**Polyurethane:** Non-marking, popular, lightweight, durable and versatile wheel. Long-lasting tread mechanically bonded to an aluminum core, wears well and are impervious to water (including salt water), resistant to oils, grease, most solvents and chemicals, typically used in commercial, industrial, institutional and food service applications. Offers excellent manoeuvrability, semi-quiet ride, adequate floor protection and good capacity ratings.

**Polyolefin:** Very durable, inexpensive, holds high capacities, has high shock load impact strength, is sanitary and is impervious to water, resistant to most oils, grease, chemicals and solvents, is non-marking and most of our polyolefin wheels have a slight crowned tread, which offers good roll ability. Great for most applications not needing a cushioned ride and that will not be exposed to heat.

**Phenolic:** A very hard, durable and versatile wheel. Of all of the hard surface wheels (compared to steel) it provides the best floor protection and is quieter. Good roll ability and are very popular wheels in the industrial, manufacturing, warehousing and bakery industries. Resists oils, grease, gasoline, and most commonly used chemicals and intermittent water exposure. Not recommended for continuous wet applications.

**Hi-Temp "Lava" Nylon:** Will not crush under heavy loads. It is good for use on all sorts of surfaces from wood to concrete. Will tolerate temperatures from -43°C (-45°F) to 246°C (475°F) and is not affected by most corrosive chemicals.

# CASTERS

## POLYOLEFIN CASTERS

- Rolls easily on most floors
- Lightweight and economical
- Non-marking, easy to maintain, steam cleanable
- High impact strength
- Superior resistance to most oils, chemicals, grease and acids

Model No.	Wheel Dia."	Style	Cap. lbs.	Tread Width"	Overall Height"	Price /Each
ML391	3	Swivel	250	1-1/4	4-1/2	9.60
ML392	3	Rigid	250	1-1/4	4-1/2	7.30
ML393	4	Swivel	250	1-1/4	5-1/4	10.80
ML394	4	Rigid	250	1-1/4	5-1/4	9.40
ML395	5	Swivel	250	1-1/4	6-1/8	12.95
ML396	5	Rigid	250	1-1/4	6-1/8	11.05

**SURFACE APPLICATIONS:**  
Concrete, brick, carpet and steel

**Plate size:** 2-5/8" x 3-3/4"  
**Bolt hole centres:** 2-3/4" x 1-3/4"  
**Bolt hole size:** 5/16"

**KLETON**



ML391

ML394

## BLUE ELASTIC RUBBER CASTERS

- High load capacity, rolls easily and quietly on all floors
- Non-marking, excellent floor protection
- Zinc chrome plated finish provides corrosion resistance
- Elastic rubber tread rejects floor debris
- Sealed double ball raceway
- Thread guards
- Ball bearing
- Total locking brake locks the wheel and keeps the swivel from turning

Model No.	Wheel Dia."	Style	Cap. lbs.	Tread Width"	Overall Height"	Price /Each
M0511*	3	Swivel	285	1-1/4	4-1/4	14.05
M0512*	3	Rigid	285	1-1/4	4-1/4	12.25
M0513*	3	Swivel w/Brake	285	1-1/4	4-1/4	18.05
ML333	4	Swivel	350	1-3/8	5	19.45
ML334	4	Rigid	350	1-3/8	5	17.45
ML342	4	Swivel w/Brake	350	1-3/8	5	23.95
ML337	5	Swivel	400	1-3/8	6	26.10
ML338	5	Rigid	400	1-3/8	6	24.05
ML345	5	Swivel w/Brake	400	1-3/8	6	32.60

\* Roller Bearing

**SURFACE APPLICATIONS:**  
Concrete, brick, carpet, steel, tile, asphalt, wood and linoleum

**Plate size:** 3-3/8" x 4"  
**Bolt hole centres:** 2-3/8" x 3-1/8"  
**Bolt hole size:** 3/8"

**KLETON**



ML342

ML333



ML334

## NYLON SANDWICH CASTERS

- Non-marking white nylon elastic rubber cushion ring layer reduces noise and vibration
- Chrome zinc-finish for corrosion resistance
- Double raceway
- Ball bearing
- Total locking brake locks the wheel and keeps the swivel from turning

Model No.	Wheel Dia."	Style	Cap. lbs.	Tread Width"	Overall Height"	Price /Each
MN441	4	Swivel	440	1-3/8	5-1/8	19.45
MN442	4	Rigid	440	1-3/8	5-1/8	17.70
MN443	4	Swivel w/Brake	440	1-3/8	5-1/8	22.90
MN444	5	Swivel	440	1-3/8	6-1/8	22.15
MN445	5	Rigid	440	1-3/8	6-1/8	20.65
MN446	5	Swivel w/Brake	440	1-3/8	6-1/8	25.40

**SURFACE APPLICATIONS:**  
Concrete, brick, carpet and steel

**Plate Size:** 3-1/3" x 4-1/8"  
**Bolt hole centres:** 3-1/8" x 2-1/3"  
**Bolt hole size:** 5/16"

**KLETON**

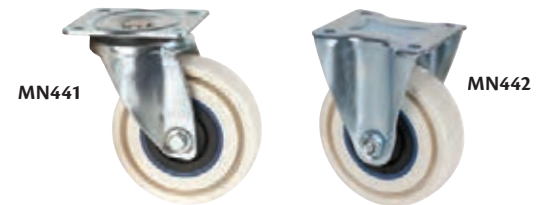

MN441

MN442



MN443

## POLYURETHANE CASTERS

- Smooth rolling, low noise operation
- Non-marking, cut & tear resistant
- Die cast aluminum core with brown polyurethane tread
- Resistant to most chemicals, moisture friendly
- Double ball raceway
- Annular ball bearing
- Total locking brake locks the wheel and keeps the swivel from turning
- Butterfly side brake locks the wheel preventing it from rolling

Model No.	Wheel Dia."	Style	Cap. lbs.	Tread Width"	Overall Height"	Price /Each
MP696	3	Swivel	230	1-1/4	4-1/4	15.20
MP695	3	Rigid	230	1-1/4	4-1/4	11.65
ML045	4	Swivel	440	1-1/2	5-3/8	25.00
ML046	4	Rigid	440	1-1/2	5-3/8	20.50
ML441	4HD	Swivel	550	1-5/8	5-5/8	28.90
ML442	4HD	Rigid	550	1-5/8	5-5/8	23.30
MN264	4HD	Swivel w/brake	550	1-5/8	5-5/8	39.45
ML397	5	Swivel	650	1-1/2	6-1/2	29.95
ML398	5	Rigid	650	1-1/2	6-1/2	25.15
MN265	5	Swivel w/brake	650	1-1/2	6-1/2	41.20
ML399	6	Swivel	850	1-1/2	7-1/2	39.70
ML400	6	Rigid	850	1-1/2	7-1/2	34.60
MN266	6	Swivel w/brake	850	1-1/2	7-1/2	56.65
MN449	6	Butterfly side brake	850	1-1/2	7-1/2	47.95
ML401	8	Swivel	1000	1-5/8	9-1/2	46.45
ML402	8	Rigid	1000	1-5/8	9-1/2	42.10
MN267	8	Swivel w/brake	1000	1-5/8	9-1/2	68.05
MN450	8	Butterfly side brake	1000	1-5/8	9-1/2	57.10

**SURFACE APPLICATIONS:**  
Concrete, brick, carpet, steel, tile, asphalt, wood and linoleum

**Plate size:** 3 = 2-5/8" x 3-3/4"  
4 = 3-1/8" x 4-1/8"  
4 HD = 4" x 4-1/2"  
5 = 4" x 4-1/2"  
6 = 4" x 4-1/2"  
8 = 4" x 4-1/2"

**Bolt hole centres:** 3 = 1-3/4" x 2-3/4"  
4 = 2-3/8" x 3-1/16"  
4 HD = 3-1/4" x 2-3/4"  
5 = 3-1/4" x 2-3/4"  
6 = 3-1/4" x 2-3/4"  
8 = 3-1/4" x 2-3/4"

**Bolt hole size:** 3 = 5/16"  
4 = 5/16"  
4 HD = 3/8"  
5 = 3/8"  
6 = 3/8"  
8 = 3/8"

**KLETON**



ML045

ML046

MN264

## HI-TEMP NYLON CASTERS

- Smooth rolling, non-marking
- Zinc chrome plated finish provides corrosion resistance
- Superior resistance to most oils, chemicals, and grease
- Double ball raceway
- Ball bearing
- Max. temperature: 230°C
- Total locking brake locks the wheel and keeps the swivel from turning
- Butterfly side brake locks the wheel preventing it from rolling

### SURFACE APPLICATIONS:

Concrete, brick, carpet and steel

**Plate Size:** 4" x 4-1/2"

**Bolt hole centers:** 3" x 3-1/3"

**Bolt hole size:** 7/16"



**KLETON**

ML862

ML863

Model No.	Wheel Dia."	Style	Cap. lbs.	Tread Width"	Overall Height"	Price /Each
ML861	6	Swivel	800	1-3/4	7-5/8	51.45
ML862	6	Rigid	800	1-3/4	7-5/8	42.60
ML863	6	Swivel W/Brake	800	1-3/4	7-5/8	55.40
MN453	6	Butterfly side brake	800	1-3/4	7-5/8	51.65
ML864	8	Swivel	850	1-3/4	9-1/2	67.35
ML865	8	Rigid	850	1-3/4	9-1/2	56.70
ML866	8	Swivel W/Brake	850	1-3/4	9-1/2	70.25
MN454	8	Butterfly side brake	850	1-3/4	9-1/2	65.35

## MOLD-ON RUBBER CASTERS

- Molded rubber wheel permanently bonded to spoked cast iron core
- Iron centre gives it strength while the molded rubber offers smooth and quiet operation
- Protects loads and surfaces
- Won't damage warehouse or factory floors
- Total locking brake locks the wheel and keeps the swivel from turning
- Butterfly side brake locks the wheel preventing it from rolling

### SURFACE APPLICATIONS:

Concrete, brick, carpet, steel, tile, asphalt, wood and linoleum

**Plate Size:** 4" x 4-1/2"

**Bolt hole centers:** 2-7/8" x 3-1/3"

**Bolt hole size:** 7/16"



**KLETON**

ML851

ML852

ML853

Model No.	Wheel Dia."	Style	Cap. lbs.	Tread Width"	Bearing Type"	Price /Each
ML846	5	Swivel	400	2	Roller	28.00
ML847	5	Rigid	400	2	Roller	22.55
ML849	6	Swivel	500	2	Roller	30.00
ML850	6	Rigid	500	2	Roller	24.95
ML851	6	Swivel w/Brake	500	2	Roller	34.90
MN451	6	Butterfly side brake	500	2	Roller	34.15
ML852	8	Swivel	600	2	Roller	43.40
ML853	8	Rigid	600	2	Roller	35.90
ML854	8	Swivel w/Brake	600	2	Roller	45.70
MN452	8	Butterfly side brake	600	2	Roller	40.75

## PNEUMATIC CASTERS

- Four ply pneumatic casters offer smooth and quiet rolling over the roughest surfaces and outdoor terrain
- Shock absorbing properties give the greatest possible protection to both the load and floor
- The "Air cushion" feature will transport the most fragile material and instruments without damage
- Not recommended for floors with metal shavings or corrosive chemicals

### SURFACE APPLICATIONS:

Concrete, brick, carpet, steel, tile, asphalt, wood and linoleum

**Plate Size:** 4" x 4-1/2"

**Bolt hole centers:** 2-3/4" x 3-3/8"

**Bolt hole size:** 13/32"

MN221



MN222

**KLETON**

Model No.	Wheel Dia."	Style	Cap. lbs.	Tread Width"	Overall Height"	Price /Each
MN222	8	Swivel	350	2	10	35.95
MN221	8	Rigid	350	2	10	30.95
MN224	10	Swivel	400	3	12	41.95
MN223	10	Rigid	400	3	12	38.95

**Note:** For optimum use pneumatic wheels must be properly inflated

## FLAT-FREE CASTERS

- Solid polyurethane wheel never runs flat
- Same bounce feel and weight of a pneumatic caster
- Smooth and quiet rolling over rough terrain and surfaces
- Less costly than traditional foam-filled tires
- Ball bearing

### SURFACE APPLICATIONS:

Concrete, brick, carpet, steel, tile, asphalt, wood and linoleum

**Plate Size:** 4" x 4-1/2"

**Bolt hole centers:** 2-3/4" x 3-3/8"

**Bolt hole size:** 13/32"



MN227

MN228

**KLETON**

Model No.	Wheel Dia."	Style	Cap. lbs.	Tread Width"	Overall Height"	Price /Each
MN226	8	Swivel	275	2	10	43.95
MN225	8	Rigid	275	2	10	40.95
MN228	10	Swivel	300	3	12	54.50
MN227	10	Rigid	300	3	12	52.75

## SEMI-PNEUMATIC WHEEL

- Soft rubber tread with steel hub and ball bearings for quiet movement
- Excellent for dollies, floor protection, quiet operation, light duty stock trucks
- Wheel Diameter: 10"
- Capacity: 200 lbs.
- Bearing Type: Ball
- Bore Size: 3/4"
- Tread Width: 2-1/2"
- Temperature: -20°F to 130°F
- Durometer: 85 - 90 A scale
- Hub Type: Offset

**Model No. MO888**  
**Price/Each \$23.95**



**KLETON**



# CASTERS

## 21 SERIES MEDIUM-DUTY POLYPROPYLENE CASTER

- Frame Material: Steel
- Tread Width: 2" (51 mm)
- Bolt Hole Spacing: 2-5/8" x 3-5/8" (67 mm x 92 mm)  
- 3" x 3" (76 mm - 76 mm)
- Bolt Hole Size: 3/8" (10 mm)
- Plate Size: 4" x 4-1/2" (102 mm x 114 mm)
- Bearing Type: Roller Bearing
- Inner Wheel Material: Polypropylene
- Shore Hardness: 70° A



Model No.	Mfg. No.	Wheel Diameter	Capacity	Caster Type	Price /Each
MP296	P21R-PB040R-14	4" (102 mm)	500 lbs. (227 kg.)	Rigid	24.90
MP295	P21S-PB040R-14	4" (102 mm)	500 lbs. (227 kg.)	Swivel	31.90
MP282	P21R-PB050R-14	5" (127 mm)	650 lbs. (294 kg.)	Rigid	29.50
MP297	P21S-PB050R-14	5" (127 mm)	650 lbs. (294 kg.)	Swivel	36.50
MP264	P21R-PB080R-14	8" (203 mm)	900 lbs. (408 kg.)	Rigid	40.50
MP279	P21S-PB080R-14	8" (203 mm)	900 lbs. (408 kg.)	Swivel	45.90

## 21 SERIES MEDIUM-DUTY THERMOPLASTIC RUBBER CASTER

- Frame Material: Steel
- Tread Width: 2" (51 mm)
- Bolt Hole Spacing: 2-5/8" x 3-5/8" (67 mm x 92 mm)  
- 3" x 3" (76 mm - 76 mm)
- Bolt Hole Size: 3/8" (10 mm)
- Plate Size: 4" x 4-1/2" (102 mm x 114 mm)
- Bearing Type: Roller Bearing
- Inner Wheel Material: Polypropylene
- Shore Hardness: 65° A



Model No.	Mfg. No.	Wheel Diameter	Capacity	Caster Type	Price /Each
MP288	P21R-RP040R-14	4" (102 mm)	300 lbs. (136 kg.)	Rigid	32.90
MP287	P21S-RP040R-14	4" (102 mm)	300 lbs. (136 kg.)	Swivel	38.90
MP298	P21R-RP050R-14	5" (127 mm)	350 lbs. (159 kg.)	Rigid	38.90
MP290	P21S-RP050R-14	5" (127 mm)	350 lbs. (159 kg.)	Swivel	44.50
MP292	P21R-RP060R-14	6" (152 mm)	500 lbs. (227 kg.)	Rigid	44.50
M0777	P21S-RP060R-14	6" (152 mm)	500 lbs. (227 kg.)	Swivel	49.50
MP294	P21R-RP080R-14	8" (203 mm)	600 lbs. (272 kg.)	Rigid	58.50
MP293	P21S-RP080R-14	8" (203 mm)	600 lbs. (272 kg.)	Swivel	63.90

## 21 SERIES MEDIUM-DUTY URETHANE CASTER

- Frame Material: Steel
- Tread Width: 2" (51 mm)
- Bolt Hole Spacing: 2-5/8" x 3-5/8" (67 mm x 92 mm)  
- 3" x 3" (76 mm - 76 mm)
- Bolt Hole Size: 3/8" (10 mm)
- Plate Size: 4" x 4-1/2" (102 mm x 114 mm)
- Bearing Type: Roller Bearing



MP270



Model No.	Mfg. No.	Wheel Diameter	Capacity	Caster Type	Price /Each
MP300	P21R-UP050R-14	5" (127 mm)	750 lbs. (340 kg.)	Rigid	39.50
MP299	P21S-UP050R-14	5" (127 mm)	750 lbs. (340 kg.)	Swivel	47.50
MP284	P21R-UP060R-14	6" (152 mm)	900 lbs. (408 kg.)	Rigid	47.50
MP283	P21S-UP060R-14	6" (152 mm)	900 lbs. (408 kg.)	Swivel	50.50
MP286	P21R-UP080R-14	8" (203 mm)	1000 lbs. (454 kg.)	Rigid	61.50
MP285	P21S-UP080R-14	8" (203 mm)	1000 lbs. (454 kg.)	Swivel	69.90
MP266	P21R-UY040R-14	4" (102 mm)	700 lbs. (317 kg.)	Rigid	37.50
MP265	P21S-UY040R-14	4" (102 mm)	700 lbs. (317 kg.)	Swivel	43.50
MP268	P21R-UY050R-14	5" (127 mm)	840 lbs. (381 kg.)	Rigid	41.90
MP267	P21S-UY050R-14	5" (127 mm)	840 lbs. (381 kg.)	Swivel	46.90
MP270	P21R-UY060R-14	6" (152 mm)	1200 lbs. (544 kg.)	Rigid	50.50
MP269	P21S-UY060R-14	6" (152 mm)	1200 lbs. (544 kg.)	Swivel	56.50
MP272	P21R-UY080R-14	8" (203 mm)	1250 lbs. (567 kg.)	Rigid	64.90
MP271	P21S-UY080R-14	8" (203 mm)	1250 lbs. (567 kg.)	Swivel	70.50

## 21 SERIES MEDIUM-DUTY PHENOLIC CASTER

- Frame Material: Steel
- Tread Width: 2" (51 mm)
- Bolt Hole Spacing: 2-5/8" x 3-5/8" (67 mm x 92 mm)  
- 3" x 3" (76 mm - 76 mm)
- Bolt Hole Size: 3/8" (10 mm)
- Plate Size: 4" x 4-1/2" (102 mm x 114 mm)
- Bearing Type: Roller Bearing
- Inner Wheel Material: Phenolic
- Shore Hardness: 90° A



Model No.	Mfg. No.	Wheel Diameter	Capacity	Caster Type	Price /Each
MP278	P21R-PH060R-14	6" (152 mm)	1200 lbs. (544 kg.)	Rigid	46.90
MP277	P21S-PH060R-14	6" (152 mm)	1200 lbs. (544 kg.)	Swivel	51.50
MP281	P21R-PH080R-14	8" (203 mm)	1250 lbs. (567 kg.)	Rigid	60.50
MP289	P21S-PH080R-14	8" (203 mm)	1250 lbs. (567 kg.)	Swivel	67.50

KLETON

CANADA'S LEADING MATERIAL HANDLING SUPPLIER

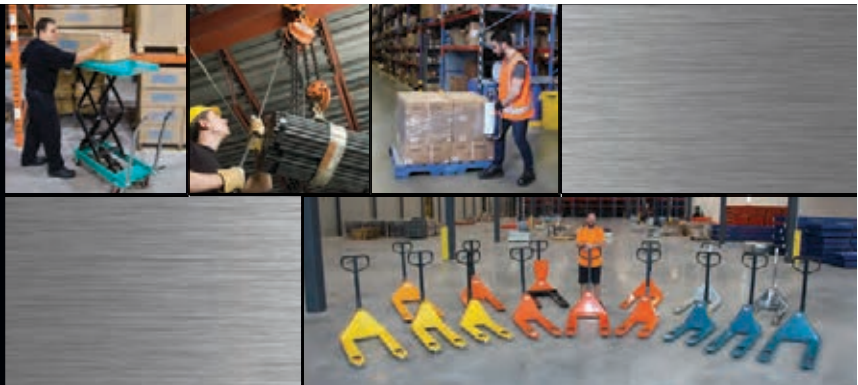

## IMPACT-RESISTANT NYLON CASTERS

- Swivel rig with double ball bearing in the swivel head
- High chemical resistance to many aggressive substances
- Minimal swivel head play and smooth rolling characteristics
- Medium heavy duty rigs, with top plate fitting
- Tread & Tire Hardness: 70° Shore D
- Low rolling and swivel resistance for smooth running performance
- Operating temperature: -15° F to +175° F
- Wheel Material: Nylon
- Frame Material: Steel

**Tread Width:** 1-1/4" (31.8 mm)

**Bolt Hole Spacing:** 1-3/4" x 2-13/16"

(44 m x 71 mm) - 1-3/4" x 3-1/16" (44 mm 78 mm)

**Bolt Size:** 5/16" (7.93 mm)

**Plate Size:** 2-1/2" x 3-5/8" (64 mm x 92 mm)



Model No.	Wheel Diameter	Capacity	Caster Type	Bearing Type	Total Height"	Price /Each
<b>MO616</b>	3-1/8" (79.5 mm)	265 lbs. (120 kg.)	Swivel	Plain Bore	4-3/8	<b>25.90</b>
<b>MO617</b>	4" (102 mm)	265 lbs. (120 kg.)	Swivel	Plain Bore	5-3/8	<b>27.50</b>
<b>MO618</b>	5" (127 mm)	265 lbs. (120 kg.)	Swivel	Plain Bore	6-5/16	<b>29.50</b>
<b>MO619</b>	3-1/8" (79.5 mm)	265 lbs. (120 kg.)	Swivel w/Brake	Plain Bore	4-3/8	<b>32.50</b>
<b>MO620</b>	4" (102 mm)	265 lbs. (120 kg.)	Swivel w/Brake	Plain Bore	5-3/8	<b>34.90</b>
<b>MO621</b>	5" (127 mm)	265 lbs. (120 kg.)	Swivel w/Brake	Plain Bore	6-5/16	<b>36.50</b>

## THERMOPLASTIC ELASTOMER CASTERS

- Swivel rig with double ball bearing in the swivel head
- High operational comfort and low-noise operation
- Minimal swivel head play and smooth rolling characteristics
- Medium heavy duty rigs, with top plate fitting
- Low rolling and swivel resistance for smooth running performance
- Tread & Tire Hardness: 85° Shore A
- Operating temperature: -4° F to +140° F

**Tread Width:** 1-1/4" (31.8 mm)

**Bolt Hole Spacing:** 1-3/4" x 2-13/16"

(44 m x 71 mm) - 1-3/4" x 3-1/16" (44 mm 78 mm)

**Bolt Size:** 5/16" (7.93 mm)

**Plate Size:** 2-1/2" x 3-5/8" (64 mm x 92 mm)



Model No.	Wheel Diameter	Capacity	Caster Type	Bearing Type	Total Height"	Price /Each
<b>MO604</b>	3-1/8" (79.5 mm)	220 lbs. (100 kg.)	Swivel	Plain Bore	4-3/8	<b>27.50</b>
<b>MO605</b>	3-1/8" (79.5 mm)	220 lbs. (100 kg.)	Swivel	Ball Bearing	4-3/8	<b>34.50</b>
<b>MO606</b>	4" (102 mm)	240 lbs. (108 kg.)	Swivel	Plain Bore	5-3/8	<b>28.50</b>
<b>MO607</b>	4" (102 mm)	240 lbs. (108 kg.)	Swivel	Ball Bearing	5-3/8	<b>32.90</b>
<b>MO608</b>	5" (127 mm)	265 lbs. (120 kg.)	Swivel	Plain Bore	6-5/16	<b>32.90</b>
<b>MO609</b>	5" (127 mm)	265 lbs. (120 kg.)	Swivel	Ball Bearing	6-5/16	<b>41.90</b>
<b>MO610</b>	3-1/8" (79.5 mm)	220 lbs. (100 kg.)	Swivel w/Brake	Plain Bore	4-3/8	<b>35.50</b>
<b>MO611</b>	3-1/8" (79.5 mm)	220 lbs. (100 kg.)	Swivel w/Brake	Ball Bearing	4-3/8	<b>41.50</b>
<b>MO612</b>	4" (102 mm)	240 lbs. (108 kg.)	Swivel w/Brake	Plain Bore	5-3/8	<b>33.50</b>
<b>MO613</b>	4" (102 mm)	240 lbs. (108 kg.)	Swivel w/Brake	Ball Bearing	5-3/8	<b>40.90</b>
<b>MO614</b>	5" (127 mm)	265 lbs. (120 kg.)	Swivel w/Brake	Plain Bore	6-5/16	<b>38.50</b>
<b>MO615</b>	5" (127 mm)	265 lbs. (120 kg.)	Swivel w/Brake	Ball Bearing	6-5/16	<b>47.50</b>

## MEDIUM-HEAVY DUTY CASTERS

### GENERAL PURPOSE

- 9/16" diameter rivet
- 3/8" diameter axle and lock nut
- Brake type: Top locking
- 1/4" diameter upper race; 1/4" diameter lower race
- Corrosion resistant bright zinc finish

### Excellent for:

- Medium-duty applications
- Mobile warehousing equipment
- Stock trucks

**Plate size:** 2 3/4" x 3 3/4"

**Bolt holes:** 1 3/4" x 2 13/16"

**Bolt hole size:** 5/16"



Wheel Dia"	Tread Width"	Bearing Type	Cap. lbs.	Swivel Radius"	Overall Height"	Wheel Type	Swivel Model No.	Price /Each	Rigid Model No.	Price /Each	Swivel w/brake Model No.	Price /Each	Rigid w/ side brake Model No.	Price /Each
3	1 1/4	Nylon	400	2 7/8	4	Phenolic	<b>MG199</b>	<b>23.30</b>	<b>MG200</b>	<b>17.20</b>	<b>MH453</b>	<b>30.70</b>	<b>MH454</b>	<b>24.70</b>
3	1 1/4	Nylon	300	2 7/8	4	Steel	<b>MG201</b>	<b>23.60</b>	<b>MG202</b>	<b>16.70</b>	<b>MH455</b>	<b>21.20</b>	<b>MH456</b>	<b>25.10</b>
3	1 1/4	Steel	350	2 7/8	4	Urethane	<b>MG203</b>	<b>18.50</b>	<b>MG204</b>	<b>12.80</b>	<b>MH457</b>	<b>23.80</b>	<b>MH458</b>	<b>26.80</b>
3	1 1/4	Steel	350	2 7/8	4	Urethane Grey	<b>MG205</b>	<b>19.80</b>	<b>MG206</b>	<b>13.10</b>	<b>MH459</b>	<b>23.50</b>	<b>MH460</b>	<b>26.80</b>
4	1 1/4	Steel	400	3 1/2	5	Phenolic	<b>MG207</b>	<b>23.00</b>	<b>MG208</b>	<b>18.30</b>	<b>MH461</b>	<b>29.50</b>	<b>MH462</b>	<b>31.90</b>
4	1 1/4	Steel	300	3 1/2	5	Steel	<b>MG209</b>	<b>27.80</b>	<b>MG210</b>	<b>19.50</b>	<b>MH463</b>	<b>36.20</b>	<b>MH464</b>	<b>29.90</b>
4	1 1/4	Steel	350	3 1/2	5	Urethane	<b>MG211</b>	<b>21.90</b>	<b>MG212</b>	<b>15.60</b>	<b>MH465</b>	<b>28.90</b>	<b>MH466</b>	<b>29.30</b>
4	1 1/4	Steel	350	3 1/2	5	Urethane Grey	<b>MG213</b>	<b>22.60</b>	<b>MG214</b>	<b>15.60</b>	<b>MH467</b>	<b>26.80</b>	<b>MH468</b>	<b>29.20</b>

### HEAVY-DUTY 550-LB. CAPACITY

- 9/16" diameter rivet
- 3/8" drilled axle and lock nut
- Corrosion resistant bright zinc finish
- Available with brake
- 1/4" diameter upper raceway
- 1/4" diameter lower raceway (equal diameter raceway)

### Excellent for:

- Platform trucks
- Food service equipment
- Hotel equipment
- Factory use
- Textile carts

**Plate size:** 3 27/32" x 4 1/2"

**Holes slotted for:** 2 5/8" to 3" x 3" to 3 5/8"

**Bolt hole size:** 3/8"

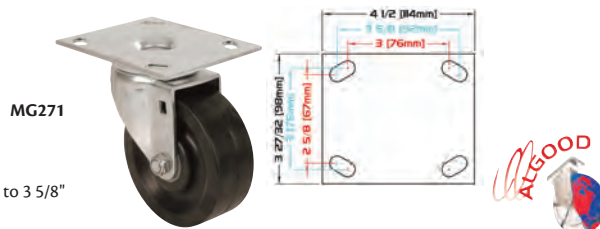

Wheel Dia"	Tread Width"	Bearing Type	Cap. lbs.	Swivel Radius"	Overall Height"	Wheel Type	Swivel Model No.	Price /Each	Rigid Model No.	Price /Each
4	1 1/2	Roller	350	3 15/16	6 1/8	Mold-On Rubber	<b>MG263</b>	<b>39.40</b>	<b>MG264</b>	<b>33.10</b>
4	1 1/2	Roller	400	3 5/16	5 1/8	Polyolefin	<b>MG265</b>	<b>34.50</b>	<b>MG266</b>	<b>28.20</b>
4	1 1/2	Roller	600	3 5/16	5 1/8	Phenolic	<b>MG267</b>	<b>38.30</b>	<b>MG268</b>	<b>32.00</b>
4	1 1/2	Roller	600	3 5/16	5 1/8	Steel	<b>MG269</b>	<b>44.00</b>	<b>MG270</b>	<b>37.70</b>
4	1 1/2	Roller	600	3 5/16	5 1/8	Envirothane™	<b>MG271</b>	<b>43.60</b>	<b>MG272</b>	<b>37.30</b>
4	1 1/2	Roller	600	3 5/16	5 1/8	V-Groove	<b>MG273</b>	<b>47.80</b>	<b>MG274</b>	<b>41.50</b>
4	1 1/2	Roller	700	3 5/16	5 1/8	RollX™ Nylon	<b>MN825</b>	<b>38.30</b>	<b>MN829</b>	<b>32.00</b>
4	1 1/2	Roller	700	3 5/16	5 1/8	Lava™ High Temp Nylon	<b>MN826</b>	<b>50.30</b>	<b>MN830</b>	<b>42.90</b>
5	1 1/2	Roller	350	3 15/16	6 1/8	Mold-On Rubber	<b>MG275</b>	<b>41.50</b>	<b>MG276</b>	<b>35.20</b>
5	1 1/2	Roller	450	3 15/16	6 1/8	Polyolefin	<b>MG277</b>	<b>33.60</b>	<b>MG278</b>	<b>29.90</b>
5	1 1/2	Roller	600	3 15/16	6 1/8	Phenolic	<b>MG279</b>	<b>41.90</b>	<b>MG280</b>	<b>36.00</b>
5	1 1/2	Roller	600	3 15/16	6 1/8	Steel	<b>MG281</b>	<b>48.80</b>	<b>MG282</b>	<b>42.50</b>
5	1 1/2	Roller	700	3 15/16	6 1/8	Envirothane™	<b>MG283</b>	<b>48.80</b>	<b>MG284</b>	<b>42.50</b>
5	1 1/2	Roller	700	3 15/16	6 1/8	RollX™ Nylon	<b>MN827</b>	<b>40.40</b>	<b>MN831</b>	<b>34.50</b>
5	1 1/2	Roller	700	3 15/16	6 1/8	Lava™ High Temp Nylon	<b>MN828</b>	<b>57.20</b>	<b>MN832</b>	<b>50.30</b>

# CASTERS

## IMPACT-RESISTANT NYLON CASTERS

- Medium heavy duty rigs, with top plate fitting
- Low rolling and swivel resistance for smooth running performance
- High chemical resistance to many aggressive substances
- Operating temperature: -15° F to +175° F
- Wheel Material: Nylon • Frame Material: Steel

**Bolt Hole Spacing:** 2-5/8" x 3-5/8"  
(67 mm x 92 mm) - 3" x 3" (76 mm x 76 mm)  
**Bolt Hole Size:** 3/8" (9.52 mm)  
**Plate Size:** 4" x 4-1/2"  
(102 mm x 114 mm)



Model No.	Wheel Diameter	Capacity	Tread Width	Bearing Type	Total Height"	Price /Each
<b>SWIVEL</b>						
M0535	3-1/8" (79.5 mm)	350 lbs. (159 kg.)	1-7/16" (37 mm)	Ball Bearing	4-3/8	58.50
M0536	4" (102 mm)	615 lbs. (280 kg.)	1-7/16" (37 mm)	Ball Bearing	5-1/8	54.90
M0537	5" (127 mm)	660 lbs. (300 kg.)	1-9/16" (40 mm)	Ball Bearing	6-1/8	52.50
M0538	6" (152 mm)	660 lbs. (300 kg.)	2" (51 mm)	Plain Bore	7-1/2	52.90
M0539	8" (203 mm)	660 lbs. (300 kg.)	2" (51 mm)	Plain Bore	9-1/4	79.50
M0540	6" (152 mm)	1250 lbs. (568 kg.)	2" (51 mm)	Ball Bearing	7-1/2	149.00
M0541	6-5/16" (160 mm)	1250 lbs. (568 kg.)	2" (51 mm)	Ball Bearing	7-7/8	145.00
M0542	8" (203 mm)	1250 lbs. (568 kg.)	2" (51 mm)	Ball Bearing	9-1/2	169.00
<b>RIGID</b>						
M0543	3-1/8" (79.5 mm)	350 lbs. (159 kg.)	1-7/16" (37 mm)	Ball Bearing	4-3/8	65.90
M0544	4" (102 mm)	615 lbs. (280 kg.)	1-7/16" (37 mm)	Ball Bearing	5-1/8	47.90
M0545	5" (127 mm)	660 lbs. (300 kg.)	1-9/16" (40 mm)	Ball Bearing	6-1/8	55.50
M0546	6" (152 mm)	660 lbs. (300 kg.)	2" (51 mm)	Plain Bore	7-1/2	46.90
M0547	8" (203 mm)	660 lbs. (300 kg.)	2" (51 mm)	Plain Bore	9-1/4	74.90
M0548	6" (152 mm)	1250 lbs. (568 kg.)	2" (51 mm)	Ball Bearing	7-1/2	129.00
M0549	6-5/16" (160 mm)	1250 lbs. (568 kg.)	2" (51 mm)	Ball Bearing	7-7/8	119.00
M0550	8" (203 mm)	1250 lbs. (568 kg.)	2" (51 mm)	Ball Bearing	9-1/2	145.00
<b>SWIVEL W/BRAKE</b>						
M0551	3-1/8" (79.5 mm)	350 lbs. (159 kg.)	1-7/16" (37 mm)	Ball Bearing	4-3/8	105.00
M0552	4" (102 mm)	615 lbs. (280 kg.)	1-7/16" (37 mm)	Ball Bearing	5-1/8	73.90
M0553	5" (127 mm)	660 lbs. (300 kg.)	1-9/16" (40 mm)	Ball Bearing	6-1/8	83.50
M0554	6" (152 mm)	660 lbs. (300 kg.)	2" (51 mm)	Plain Bore	7-1/2	88.90
M0555	8" (203 mm)	660 lbs. (300 kg.)	2" (51 mm)	Plain Bore	9-1/4	105.00
M0556	6" (152 mm)	1250 lbs. (568 kg.)	2" (51 mm)	Ball Bearing	7-1/2	175.00
M0557	6-5/16" (160 mm)	1250 lbs. (568 kg.)	2" (51 mm)	Ball Bearing	7-7/8	165.00
M0558	8" (203 mm)	1250 lbs. (568 kg.)	2" (51 mm)	Ball Bearing	9-1/2	199.00

## HIGH-QUALITY THERMOPLASTIC CASTERS

- Low-noise operation, rolling and swivel resistance
- Non-marking, non-staining surface
- High chemical resistance to many aggressive substances
- Operating temperature: -15° F to +160° F
- Wheel Material: Thermoplastic Polyurethane • Frame Material: Steel

**Bolt Hole Spacing:** 2-5/8" x 3-5/8"  
(67 mm x 92 mm) - 3" x 3" (76 mm x 76 mm)  
**Bolt Hole Size:** 3/8" (9.52 mm)  
**Plate Size:** 4" x 4-1/2"  
(102 mm x 114 mm)  
**Bearing Type:** Ball Bearing



Model No.	Wheel Diameter	Capacity	Tread Width	Caster Type	Total Height"	Price /Each
M0574	3-1/8" (79.5 mm)	330 lbs. (150 kg.)	1-1/4" (31.8 mm)	Swivel	4-3/8	62.90
M0575	4" (102 mm)	440 lbs. (200 kg.)	1-1/4" (31.8 mm)	Swivel	5-1/8	63.50
M0576	5" (127 mm)	550 lbs. (250 kg.)	1-1/4" (31.8 mm)	Swivel	6-1/8	65.90
M0577	6" (152 mm)	660 lbs. (300 kg.)	1-9/16" (40 mm)	Swivel	7-11/16	93.90
M0578	8" (203 mm)	660 lbs. (300 kg.)	1-9/16" (40 mm)	Swivel	9-1/4	105.00
M0579	3-1/8" (79.5 mm)	330 lbs. (150 kg.)	1-1/4" (31.8 mm)	Rigid	4-3/8	55.50
M0580	4" (102 mm)	440 lbs. (200 kg.)	1-1/4" (31.8 mm)	Rigid	5-1/8	53.50
M0581	5" (127 mm)	550 lbs. (250 kg.)	1-1/4" (31.8 mm)	Rigid	6-1/8	61.50
M0582	6" (152 mm)	660 lbs. (300 kg.)	1-9/16" (40 mm)	Rigid	7-11/16	81.50
M0583	8" (203 mm)	660 lbs. (300 kg.)	1-9/16" (40 mm)	Rigid	9-1/4	86.90
M0584	3-1/8" (79.5 mm)	330 lbs. (150 kg.)	1-1/4" (31.8 mm)	Swivel w/Brake	4-3/8	92.90
M0585	4" (102 mm)	440 lbs. (200 kg.)	1-1/4" (31.8 mm)	Swivel w/Brake	5-1/8	79.90
M0586	5" (127 mm)	550 lbs. (250 kg.)	1-1/4" (31.8 mm)	Swivel w/Brake	6-1/8	85.50
M0587	6" (152 mm)	660 lbs. (300 kg.)	1-9/16" (40 mm)	Swivel w/Brake	7-11/16	115.00
M0588	8" (203 mm)	660 lbs. (300 kg.)	1-9/16" (40 mm)	Swivel w/Brake	9-1/4	125.00

## HIGH-QUALITY POLYURETHANE ELASTOMER CASTERS

- High operational comfort due to extremely thick, elastic tread
- Low-noise operation and rolling resistance
- High abrasion resistance, cut and tear propagation resistance
- Operating temperature: -15° F to +160° F
- Wheel Material: Polyurethane Elastomer • Frame Material: Steel

**Bolt Hole Spacing:** 2-5/8" x 3-5/8"  
(67 mm x 92 mm) - 3" x 3" (76 mm x 76 mm)  
**Bolt Hole Size:** 3/8" (9.52 mm)  
**Plate Size:** 4" x 4-1/2" (102 mm x 114 mm)

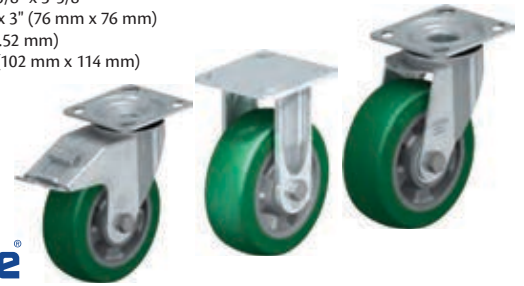

Model No.	Wheel Diameter	Capacity	Tread Width	Bearing Type	Total Height"	Price /Each
<b>SWIVEL</b>						
M0559	3-1/8" (79.5 mm)	505 lbs. (230 kg.)	1-9/16" (40 mm)	Ball Bearing	4-3/8	105.00
M0560	4" (102 mm)	660 lbs. (300 kg.)	1-9/16" (40 mm)	Ball Bearing	5-1/8	109.00
M0561	5" (127 mm)	770 lbs. (350 kg.)	1-9/16" (40 mm)	Ball Bearing	6-1/8	119.00
M0562	6" (152 mm)	660 lbs. (300 kg.)	2-1/8" (54 mm)	Ball Bearing	7-1/2	149.00
M0563	8" (203 mm)	660 lbs. (300 kg.)	2" (51 mm)	Ball Bearing	9-1/4	189.00
<b>RIGID</b>						
M0564	3-1/8" (79.5 mm)	505 lbs. (230 kg.)	1-9/16" (40 mm)	Ball Bearing	4-3/8	95.50
M0565	4" (102 mm)	660 lbs. (300 kg.)	1-9/16" (40 mm)	Ball Bearing	5-1/8	94.90
M0566	5" (127 mm)	770 lbs. (350 kg.)	1-9/16" (40 mm)	Ball Bearing	6-1/8	115.00
M0567	6" (152 mm)	660 lbs. (300 kg.)	2-1/8" (54 mm)	Ball Bearing	7-1/2	155.00
M0568	8" (203 mm)	660 lbs. (300 kg.)	2" (51 mm)	Ball Bearing	9-1/4	179.00
<b>SWIVEL W/BRAKE</b>						
M0569	3-1/8" (79.5 mm)	505 lbs. (230 kg.)	1-9/16" (40 mm)	Ball Bearing	4-3/8	145.00
M0570	4" (102 mm)	660 lbs. (300 kg.)	1-9/16" (40 mm)	Ball Bearing	5-1/8	125.00
M0571	5" (127 mm)	770 lbs. (350 kg.)	1-9/16" (40 mm)	Ball Bearing	6-1/8	139.00
M0572	6" (152 mm)	660 lbs. (300 kg.)	2-1/8" (54 mm)	Ball Bearing	7-1/2	189.00
M0573	8" (203 mm)	660 lbs. (300 kg.)	2" (51 mm)	Ball Bearing	9-1/4	225.00

## HIGH-QUALITY POLYURETHANE ELASTOMER CASTERS

- Low-noise operation and rolling resistance
- High abrasion resistance, cut and tear propagation resistance
- Non-marking, non-staining surface
- Operating temperature: -15° F to +160° F
- Wheel Material: Polyurethane Elastomer • Frame Material: Steel

**Bolt Hole Spacing:** 2-5/8" x 3-5/8" (67 mm x 92 mm) - 3" x 3" (76 mm x 76 mm)  
**Bolt Hole Size:** 3/8" (9.52 mm)  
**Plate Size:** 4" x 4-1/2" (102 mm x 114 mm)  
**Bearing Type:** Ball Bearing

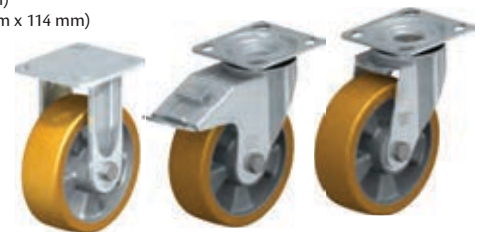

Model No.	Wheel Diameter	Capacity	Tread Width	Caster Type	Total Height"	Price /Each
M0589	3-1/8" (79.5 mm)	395 lbs. (180 kg.)	1-1/8" (28.6 mm)	Swivel	4-3/8	80.50
M0590	4" (102 mm)	550 lbs. (250 kg.)	1-9/16" (40 mm)	Swivel	5-1/8	99.50
M0591	5" (127 mm)	770 lbs. (350 kg.)	1-9/16" (40 mm)	Swivel	6-1/8	115.00
M0592	6" (152 mm)	660 lbs. (300 kg.)	2" (51 mm)	Swivel	7-1/2	129.00
M0593	8" (203 mm)	660 lbs. (300 kg.)	2" (51 mm)	Swivel	9-1/4	169.00
M0594	3-1/8" (79.5 mm)	395 lbs. (180 kg.)	1-1/8" (28.6 mm)	Rigid	4-3/8	78.50
M0595	4" (102 mm)	550 lbs. (250 kg.)	1-9/16" (40 mm)	Rigid	5-1/8	91.50
M0596	5" (127 mm)	770 lbs. (350 kg.)	1-9/16" (40 mm)	Rigid	6-1/8	109.00
M0597	6" (152 mm)	660 lbs. (300 kg.)	2" (51 mm)	Rigid	7-1/2	125.00
M0598	8" (203 mm)	660 lbs. (300 kg.)	2" (51 mm)	Rigid	9-1/4	145.00
M0599	3-1/8" (79.5 mm)	395 lbs. (180 kg.)	1-1/8" (28.6 mm)	Swivel w/Brake	4-3/8	139.00
M0600	4" (102 mm)	550 lbs. (250 kg.)	1-9/16" (40 mm)	Swivel w/Brake	5-1/8	119.00
M0601	5" (127 mm)	770 lbs. (350 kg.)	1-9/16" (40 mm)	Swivel w/Brake	6-1/8	139.00
M0602	6" (152 mm)	660 lbs. (300 kg.)	2" (51 mm)	Swivel w/Brake	7-1/2	169.00
M0603	8" (203 mm)	660 lbs. (300 kg.)	2" (51 mm)	Swivel w/Brake	9-1/4	195.00



## STAINLESS STEEL CASTERS

- Swivel rig with double ball bearing in the swivel head
- Minimal swivel head play and smooth rolling characteristics
- Medium heavy duty rigs, with top plate fitting
- Low rolling and swivel resistance for smooth running performance

- High operational comfort and low-noise operation
- Operating temperature: -4° F to +140° F
- Wheel Material: Thermoplastic Rubber-Elastomer
- Frame Material: Stainless Steel



Model No.	Wheel Diameter" (mm)	Capacity	Tread Width (mm)	Bolt Hole Spacing (mm)	Bolt Hole Size (mm)	Plate Size (mm)	Bearing Type	Height"	Price/Ea
<b>SWIVEL</b>									
M0622	2" (51)	110 lbs. (50 kg.)	3/4" (19)	1-1/2" x 1-1/2" (38 x 38) - 1-7/8" x 1-7/8" (48 x 48)	1/2" (6.35)	2-3/8" x 2-3/8" (60 x 60)	Plain Bore	2-13/16	57.50
M0623	2" (51)	110 lbs. (50 kg.)	3/4" (19)	1-1/2" x 1-1/2" (38 x 38) - 1-7/8" x 1-7/8" (48 x 48)	1/2" (6.35)	2-3/8" x 2-3/8" (60 x 60)	Ball Bearing	2-13/16	59.50
M0624	3" (76)	165 lbs. (75 kg.)	1" (25.4)	1-1/2" x 1-1/2" (38 x 38) - 1-7/8" x 1-7/8" (48 x 48)	1/2" (6.35)	2-3/8" x 2-3/8" (60 x 60)	Plain Bore	4	65.50
M0625	3" (76)	165 lbs. (75 kg.)	1" (25.4)	1-1/2" x 1-1/2" (38 x 38) - 1-7/8" x 1-7/8" (48 x 48)	1/2" (6.35)	2-3/8" x 2-3/8" (60 x 60)	Ball Bearing	4	65.50
M0626	3-1/8" (79.5)	220 lbs. (100 kg.)	1-1/4" (31.8)	1-3/4" x 2-13/16" (44 x 71) - 1-3/4" x 3-1/16" (44 x 78)	5/16" (7.93)	2-1/2" x 3-5/8" (64 x 92)	Plain Bore	4-3/8	60.90
M0627	3-1/8" (79.5)	220 lbs. (100 kg.)	1-1/4" (31.8)	1-3/4" x 2-13/16" (44 x 71) - 1-3/4" x 3-1/16" (44 x 78)	5/16" (7.93)	2-1/2" x 3-5/8" (64 x 92)	Ball Bearing	4-3/8	71.90
M0628	4" (102)	240 lbs. (108 kg.)	1-1/4" (31.8)	1-3/4" x 2-13/16" (44 x 71) - 1-3/4" x 3-1/16" (44 x 78)	5/16" (7.93)	2-1/2" x 3-5/8" (64 x 92)	Plain Bore	5-3/8	69.50
M0629	4" (102)	240 lbs. (108 kg.)	1-1/4" (31.8)	1-3/4" x 2-13/16" (44 x 71) - 1-3/4" x 3-1/16" (44 x 78)	5/16" (7.93)	2-1/2" x 3-5/8" (64 x 92)	Ball Bearing	5-3/8	70.50
M0630	5" (127)	265 lbs. (120 kg.)	1-1/4" (31.8)	1-3/4" x 2-13/16" (44 x 71) - 1-3/4" x 3-1/16" (44 x 78)	5/16" (7.93)	2-1/2" x 3-5/8" (64 x 92)	Plain Bore	6-5/16	70.90
M0631	5" (127)	265 lbs. (120 kg.)	1-1/4" (31.8)	1-3/4" x 2-13/16" (44 x 71) - 1-3/4" x 3-1/16" (44 x 78)	5/16" (7.93)	2-1/2" x 3-5/8" (64 x 92)	Ball Bearing	6-5/16	83.90
<b>RIGID</b>									
M0632	2" (51)	110 lbs. (50 kg.)	3/4" (19)	1-1/2" x 1-1/2" (38 x 38) - 1-7/8" x 1-7/8" (48 x 48)	1/2" (6.35)	2-3/8" x 2-3/8" (60 x 60)	Plain Bore	2-13/16	32.90
M0633	2" (51)	110 lbs. (50 kg.)	3/4" (19)	1-1/2" x 1-1/2" (38 x 38) - 1-7/8" x 1-7/8" (48 x 48)	1/2" (6.35)	2-3/8" x 2-3/8" (60 x 60)	Ball Bearing	2-13/16	37.90
M0634	3" (76)	165 lbs. (75 kg.)	1" (25.4)	1-1/2" x 1-1/2" (38 x 38) - 1-7/8" x 1-7/8" (48 x 48)	1/2" (6.35)	2-3/8" x 2-3/8" (60 x 60)	Plain Bore	4	40.90
M0635	3" (76)	165 lbs. (75 kg.)	1" (25.4)	1-1/2" x 1-1/2" (38 x 38) - 1-7/8" x 1-7/8" (48 x 48)	1/2" (6.35)	2-3/8" x 2-3/8" (60 x 60)	Ball Bearing	4	44.50
M0636	3-1/8" (79.5)	220 lbs. (100 kg.)	1-1/4" (31.8)	1-3/4" x 2-13/16" (44 x 71) - 1-3/4" x 3-1/16" (44 x 78)	5/16" (7.93)	2-1/2" x 3-5/8" (64 x 92)	Plain Bore	4-3/8	56.50
M0637	3-1/8" (79.5)	220 lbs. (100 kg.)	1-1/4" (31.8)	1-3/4" x 2-13/16" (44 x 71) - 1-3/4" x 3-1/16" (44 x 78)	5/16" (7.93)	2-1/2" x 3-5/8" (64 x 92)	Ball Bearing	4-3/8	65.90
M0638	4" (102)	240 lbs. (108 kg.)	1-1/4" (31.8)	1-3/4" x 2-13/16" (44 x 71) - 1-3/4" x 3-1/16" (44 x 78)	5/16" (7.93)	2-1/2" x 3-5/8" (64 x 92)	Plain Bore	5-3/8	62.90
M0639	4" (102)	240 lbs. (108 kg.)	1-1/4" (31.8)	1-3/4" x 2-13/16" (44 x 71) - 1-3/4" x 3-1/16" (44 x 78)	5/16" (7.93)	2-1/2" x 3-5/8" (64 x 92)	Ball Bearing	5-3/8	72.50
M0640	5" (127)	265 lbs. (120 kg.)	1-1/4" (31.8)	1-3/4" x 2-13/16" (44 x 71) - 1-3/4" x 3-1/16" (44 x 78)	5/16" (7.93)	2-1/2" x 3-5/8" (64 x 92)	Plain Bore	6-5/16	67.50
M0641	5" (127)	265 lbs. (120 kg.)	1-1/4" (31.8)	1-3/4" x 2-13/16" (44 x 71) - 1-3/4" x 3-1/16" (44 x 78)	5/16" (7.93)	2-1/2" x 3-5/8" (64 x 92)	Ball Bearing	6-5/16	79.90
<b>SWIVEL W/BRAKE</b>									
M0642	2" (51)	110 lbs. (50 kg.)	3/4" (19)	1-1/2" x 1-1/2" (38 x 38) - 1-7/8" x 1-7/8" (48 x 48)	1/2" (6.35)	2-3/8" x 2-3/8" (60 x 60)	Plain Bore	2-13/16	73.50
M0643	2" (51)	110 lbs. (50 kg.)	3/4" (19)	1-1/2" x 1-1/2" (38 x 38) - 1-7/8" x 1-7/8" (48 x 48)	1/2" (6.35)	2-3/8" x 2-3/8" (60 x 60)	Ball Bearing	2-13/16	74.90
M0644	3" (76)	165 lbs. (75 kg.)	1" (25.4)	1-1/2" x 1-1/2" (38 x 38) - 1-7/8" x 1-7/8" (48 x 48)	1/2" (6.35)	2-3/8" x 2-3/8" (60 x 60)	Plain Bore	4	78.90
M0645	3" (76)	165 lbs. (75 kg.)	1" (25.4)	1-1/2" x 1-1/2" (38 x 38) - 1-7/8" x 1-7/8" (48 x 48)	1/2" (6.35)	2-3/8" x 2-3/8" (60 x 60)	Ball Bearing	4	79.50
M0646	3-1/8" (79.5)	220 lbs. (100 kg.)	1-1/4" (31.8)	1-3/4" x 2-13/16" (44 x 71) - 1-3/4" x 3-1/16" (44 x 78)	5/16" (7.93)	2-1/2" x 3-5/8" (64 x 92)	Plain Bore	4-3/8	70.90
M0647	3-1/8" (79.5)	220 lbs. (100 kg.)	1-1/4" (31.8)	1-3/4" x 2-13/16" (44 x 71) - 1-3/4" x 3-1/16" (44 x 78)	5/16" (7.93)	2-1/2" x 3-5/8" (64 x 92)	Ball Bearing	4-3/8	78.90
M0648	4" (102)	240 lbs. (108 kg.)	1-1/4" (31.8)	1-3/4" x 2-13/16" (44 x 71) - 1-3/4" x 3-1/16" (44 x 78)	5/16" (7.93)	2-1/2" x 3-5/8" (64 x 92)	Plain Bore	5-3/8	83.50
M0649	4" (102)	240 lbs. (108 kg.)	1-1/4" (31.8)	1-3/4" x 2-13/16" (44 x 71) - 1-3/4" x 3-1/16" (44 x 78)	5/16" (7.93)	2-1/2" x 3-5/8" (64 x 92)	Ball Bearing	5-3/8	84.50
M0650	5" (127)	265 lbs. (120 kg.)	1-1/4" (31.8)	1-3/4" x 2-13/16" (44 x 71) - 1-3/4" x 3-1/16" (44 x 78)	5/16" (7.93)	2-1/2" x 3-5/8" (64 x 92)	Plain Bore	6-5/16	80.50
M0651	5" (127)	265 lbs. (120 kg.)	1-1/4" (31.8)	1-3/4" x 2-13/16" (44 x 71) - 1-3/4" x 3-1/16" (44 x 78)	5/16" (7.93)	2-1/2" x 3-5/8" (64 x 92)	Ball Bearing	6-5/16	92.50

## STAINLESS STEEL CASTERS

- Medium heavy duty rigs, with top plate fitting
- Low rolling and swivel resistance for smooth running performance
- High operational comfort and low-noise operation
- Frame Material: Stainless Steel
- Bearing Type: Ball Bearing

**Bolt Hole Spacing:** 2-5/8" x 3-5/8"  
(67 mm x 92 mm) - 3" x 3" (76 mm x 76 mm)  
**Bolt Hole Size:** 3/8" (9.52 mm)  
**Plate Size:** 4" x 4-1/2" (102 mm x 114 mm)



Model No.	Wheel Diameter (mm)	Capacity	Tread Width (mm)	Caster Type	Operating Temperature	Wheel Material	Height"	Price/Each
M0704	4" (127)	660 lbs. (300 kg.)	1-3/8" (35)	Swivel	-15° F to +160° F	Thermoplastic Polyurethane	5-1/8	175.00
M0705	5" (127)	770 lbs. (350 kg.)	1-9/16" (40)	Swivel	-15° F to +160° F	Thermoplastic Polyurethane	6-1/8	179.00
M0706	4" (102)	330 lbs. (150 kg.)	1-1/2" (38)	Swivel	-15° F to +175° F	Rubber	5-1/8	169.00
M0707	5" (127)	330 lbs. (150 kg.)	1-9/16" (40)	Swivel	-15° F to +175° F	Rubber	6-1/8	189.00
M0708	4" (102)	660 lbs. (300 kg.)	1-3/8" (35)	Rigid	-15° F to +160° F	Thermoplastic Polyurethane	5-1/8	109.00
M0709	5" (127)	770 lbs. (350 kg.)	1-9/16" (40)	Rigid	-15° F to +160° F	Thermoplastic Polyurethane	6-1/8	109.00
M0710	4" (102)	330 lbs. (150 kg.)	1-1/2" (38)	Rigid	-15° F to +175° F	Rubber	5-1/8	109.00
M0711	5" (127)	330 lbs. (150 kg.)	1-9/16" (40)	Rigid	-15° F to +175° F	Rubber	6-1/8	109.00
M0712	4" (102)	660 lbs. (300 kg.)	1-3/8" (35)	Swivel w/ Brake	-15° F to +160° F	Thermoplastic Polyurethane	5-1/8	209.00
M0713	5" (127)	770 lbs. (350 kg.)	1-9/16" (40)	Swivel w/ Brake	-15° F to +160° F	Thermoplastic Polyurethane	6-1/8	205.00
M0714	4" (102)	330 lbs. (150 kg.)	1-1/2" (38)	Swivel w/ Brake	-15° F to +175° F	Rubber	5-1/8	189.00
M0715	5" (127)	330 lbs. (150 kg.)	1-9/16" (40)	Swivel w/ Brake	-15° F to +175° F	Rubber	6-1/8	189.00

## FLOOR LOCK BRAKES

### STANDARD-DUTY

- Economical floor locks to stabilize mobile equipment
- Spring-loaded with non-skid rubber pad
- Steel construction with bright zinc-plated finish

**Plate size:** 4 1/2" x 4"  
**Bolt hole centres:** 3 5/8" x 3"  
**Bolt hole size:** 3/8"

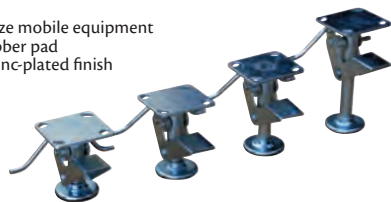

Model No.	Extended Height"	Retracted Height"	Caster Total Height"	Price /Each
ML630	6	5-3/32	5-5/8	33.50
ML631	6-13/16	5-3/4	6-1/2	48.50
ML632	7-23/32	6-3/4	7-1/2	50.50
ML633	9-13/16	8-3/4	9-1/2	50.50

### HEAVY-DUTY

- Heavy-duty industrial strength construction
- Foot pedal easily activates lock with foot pressure
- Non-slip, non-skid rubber brake pad holds securely on smooth or irregular floor
- Designed for use on level surfaces
- Durable, high compression spring for heavy loads
- Conveniently located release bar retracts brake instantly with slight toe pressure to either side of the bar
- 8" w floor lock profile



**Plate size:** 2 1/2" x 3 5/8"  
**Holes slotted for:** 1 3/4" x 2 7/8" to 3"  
**Bolt hole size:** 5/16"

Model No.	Extended Height"	Retracted Height"	Price /Each	Model No.	Extended Height"	Retracted Height"	Price /Each
MD795	4 3/4	3 11/16	70.50	MD798	5 7/8	4 15/16	93.90
MD796	5 17/32	4 1/2	71.90	MD799	6 43/64	5 35/64	97.50
MD797	6 7/32	5 11/64	73.90	MD800	7 3/4	6 21/32	92.90
				MD801	9 23/32	8 5/8	95.50

# CASTERS

## HEAVY-PRESSED STEEL CASTERS

- Tread & Tire Hardness: 70° Shore D
- Swivel rig with double ball bearing in the swivel head
- Minimal swivel head play and smooth rolling characteristics
- Medium heavy duty rigs, with top plate fitting
- Low rolling and swivel resistance for smooth running performance
- High chemical resistance to many aggressive substances
- Operating Temperature: -15° F to +175° F
- Wheel Material: Steel
- Caster Type: Swivel

**Bolt Hole Spacing:** 3-1/4" x 2-3/8" (83 mm x 60 mm)

**Bolt Hole Size:** 11/32" (8.73 mm)

**Plate Size:** 4" x 3-3/8" (102 mm x 86 mm)



Model No.	Wheel Diameter (mm)	Capacity	Tread Width (mm)	Bearing Type	Total Height	Price /Each
M0697	3" (76)	440 lbs. (200 kg.)	1-1/4" (31.8)	Plain Bore	4-3/4"	245.00
M0698	3" (76)	660 lbs. (300 kg.)	1-1/4" (31.8)	Plain Bore	4-3/4"	239.00
M0699	3" (76)	660 lbs. (300 kg.)	1-1/2" (38)	Ball Bearing	4-3/4"	255.00
M0700	3-1/4" (82.5)	660 lbs. (300 kg.)	1-7/16" (37)	Ball Bearing	4-3/4"	259.00
M0701	3-1/4" (82.5)	505 lbs. (230 kg.)	1-7/16" (37)	Plain Bore	4-3/4"	245.00
M0702	4" (102)	505 lbs. (230 kg.)	1-7/16" (37)	Plain Bore	5-5/8"	249.00
M0703	4" (102)	505 lbs. (230 kg.)	1-7/16" (37)	Ball Bearing	5-5/8"	255.00

## LOW-PROFILE CASTERS

- Swivel rig with double ball bearing in the swivel head
- Minimal swivel head play and smooth rolling characteristics
- Medium heavy duty rigs, with top plate fitting
- Low rolling and swivel resistance for smooth running performance
- High abrasion resistance
- Operating Temperature: -15° F to +175° F
- Wheel Material: Nylon
- Caster Type: Swivel
- Frame Material: Steel



Model No.	Wheel Diameter (mm)	Capacity	Tread Width (mm)	Bolt Hole Spacing (mm)	Bolt Hole Size (mm)	Plate Size (mm)	Bearing Type	Total Height	Price /Each
M0716	1-3/8" (35)	165 lbs. (75 kg.)	1" (25.4)	1-1/2" x 1-1/2" (38 x 38)	1-7/8" x 1-7/8" (48 x 48)	2-3/8" x 2-3/8" (60 x 60)	Plain Bore	2"	11.90
M0717*	1-3/8" (35)	220 lbs. (100 kg.)	1-1/8" (28.6)	1-1/2" x 1-1/2" (38 x 38)	1-7/8" x 1-7/8" (48 x 48)	2-3/8" x 2-3/8" (60 x 60)	Ball Bearing	2"	26.50
M0718	1-3/8" (35)	220 lbs. (100 kg.)	1-1/8" (28.6)	1-1/2" x 1-1/2" (38 x 38)	1-7/8" x 1-7/8" (48 x 48)	2-3/8" x 2-3/8" (60 x 60)	Ball Bearing	2"	51.90
M0719	2" (51)	264 lbs. (120 kg.)	1-1/8" (28.6)	3" x 1-7/8" (76 x 48)	2-3/8" x 2" (60 x 51)	3-1/2" x 2-1/2" (89 x 64)	Plain Bore	3"	44.50

\*Wheel Material: Polyurethane (-15° F to +160° F)

## WHEELS

### NYLON

- PO Series, high quality impact resistant wheels
- Temperature Range: -25°C to 80°C (-13°F to 176°F)

### HEAT-RESISTANT

- POHI Series, high quality, impact resistant wheels
- Highly heat-resistant nylon
- Very low rolling and swiveling resistance
- Smooth running performance on even floor
- Very high abrasion resistance, suitable for autoclaves
- Temperature Range: -25°C to 250°C (-13°F to 482°F)

### SOLID RUBBER

- POEV Series, high quality, impact resistant, smooth rolling wheels
- "Blickle Easy Roll" design
- Very high operational comfort, low-noise operation, low rolling resistance
- Very good floor preservation, vulcanized on the wheel centre
- Temperature Range: -25°C to 80°C (-13°F to 176°F)

### THERMOPLASTIC POLYURETHANE

- POTH Series, high quality, high operational comfort, low-noise operation wheels
- Low rolling and swiveling resistance, good floor preservation
- Very high abrasion resistance, chemically bonded for an inseparable connection to the wheel centre
- Temperature Range: -25°C to 70°C (-13°F to 158°F)

Model No.	Mfg. No.	Wheel Dia"	Tread Width"	Bearing Type	Capacity lbs.	Axle Bore"	Hub Length"	Wheel Material	Price /Each
MN742	PO 80/12G	3.15	1.26	Plain	485	0.472	0.472	Nylon	5.99
MN743	PO 100/12G	3.93	1.46	Plain	617	0.472	1.771	Nylon	9.29
MN744	PO125 12G	4.92	1.57	Plain	660	0.590	1.771	Nylon	12.90
MN745	PO 160/20R	6.29	1.97	Roller	992	0.787	2.362	Nylon	28.90
MN755	POHI 81/12G	3.15	1.26	Plain	396	0.472	1.378	Heat-Resistant Nylon	29.50
MN756	POHI 102/12G	3.93	1.50	Plain	550	0.472	1.771	Heat-Resistant Nylon	41.50
MN757	POHI 125/12G	4.92	1.57	Plain	660	0.472	1.771	Heat-Resistant Nylon	61.50
MN746	POEV 80/12R-SB	3.15	1.26	Roller	308	0.472	1.378	Solid Rubber	17.90
MN747	POEV 101/8K-SB-FK	3.93	1.50	Ball	440	0.314	1.811	Solid Rubber	27.50
MN748	POEV 126/8K-SB-FK	4.92	1.57	Ball	550	0.314	1.811	Solid Rubber	31.90
MN749	POEV 160/20R-SB	6.29	1.97	Roller	880	0.787	2.362	Solid Rubber	68.90
MN750	POEV 200/20R-SB	7.87	1.97	Roller	1100	0.787	2.362	Solid Rubber	93.90
MN751	POTH 100/12R	3.93	1.38	Roller	660	0.472	1.771	Thermoplastic Polyurethane	27.50
MN752	POTH 125/12R	4.92	1.57	Roller	770	0.472	1.771	Thermoplastic Polyurethane	34.90
MN753	POTH 160/20R	6.29	1.77	Roller	1212	0.787	2.362	Thermoplastic Polyurethane	57.90
MN754	POTH 200/20R	7.87	1.97	Roller	1760	0.787	2.362	Thermoplastic Polyurethane	90.50

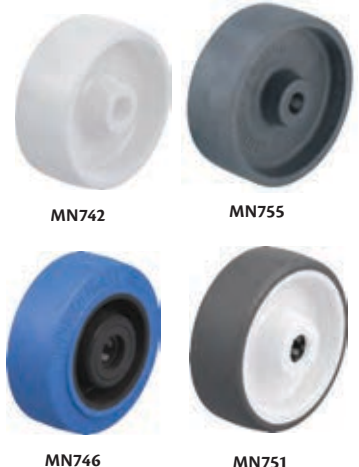

## STEEL DRUMS

- Open head 45 imp. gal/55 US gallon design complies with stringent UN regulations for packing non-dangerous and dangerous goods in packing groups II and III; salvage drum is good for packaging groups I, II and III in solids only
- Closed head 45 imp. gal/55 US gallon design meets UN regulations for packing of dangerous and non-dangerous goods in the packaging groups II and III and also complies with ISO 15750 standard and other major international standards for steel drums (ANSI, EN) and feature 2" x 3/4" Rieke® fittings
- Drum Gauge: 20/18 ga.
- Dimensions: 22-1/2" W x 34-1/2" H
- Accepted for use in Canadian food processing facilities



### UN Regulations:

A) 1A2/Y1.4/140 B) 1A2/Y275/S C) 1A1/X1.8/300

Unlined Model No.	UN Compliance	Lined Model No.	UN Compliance	Head Type	Capacity U.S. Gallons	Unlined Price /Each	Lined Price /Each
DC145	A	DC146	B	Open	55	329.00	345.00
DC147*	C	DC461**	C	Closed	55	309.00	305.00

\*Not accepted for use in Canadian food processing facilities \*\* Unit is white

### ACCESSORIES

Model No.	Description	Price /Each
DC570	Steel Drum Lid for 55 US Gal. Drum, No Fittings	45.90
DC568	Steel Drum Locking Ring for US 55 Gal. Drum	23.90
DC569	Steel Drum Bolt Only for Locking Ring	3.39

## LIQUIPAK® FIBRE DRUMS

- Interior is lined with heavy duty polyethylene
- The full-open top assures quick filling and dispensing, while the plastic covers and steel chimes reinforce top and bottom
- Will not corrode and contaminate product
- Made of FDA compliant materials
- Complete with bung and vent poly cover and locking ring
- Lined

Model No.	Capacity Gallons	Lid Material	Price /Each
DC548	30	Plastic	179.00



## LOK-RIM® FIBRE DRUMS

- Provides thermal insulation and protects sensitive products
- The unique Lok-Rim® closure allows easy opening and closing
- Will not corrode and contaminate product
- Compatible with semi-liquids when a polyethylene insert/bag is applied
- Made of FDA compliant materials
- Includes locking ring and cover
- Unlined

Model No.	Capacity Gallons	Lid Material	UN Compliance	Price /Each
DC543	30	Plastic	Y115	169.00
DC546	55	Fibre	None	129.00
DC547	55	Steel	Y200	149.00



## STEEL SALVAGE DRUMS

- Salvage drums are recommended for containing leaking drums of petroleum solvents
- Includes 12-gauge ring and hoop closure
- Drums are lined with an open head steel top

DC445



Model No.	Capacity US Gallons	Description	UN Compliance	Steel Gauge	Wt. lbs.	Price /Each
DC445	85	Lined	UN1A2/X440/S	18	60	749.00
DC448	85	Lined	UN1A2/X440/S	16	82	945.00

## POLYETHYLENE DRUMS

- UN-approved plastic drums are manufactured using state-of-the-art technologies to meet the stringent demands of chemical compatibility with hazardous and non-hazardous products as well as reliability and safety requirements
- Drums are made from a high molecular weight, high-density polyethylene resin which makes them extremely strong and rigid
- Open head drums come standard with cover and steel lever-locking ring
- Capacity is based on US gal. readings
- Accepted for use in Canadian food processing facilities



Model No.	Capacity Gallons	Colour	Top	UN Compliance	Price /Each
DC525	55	Blue	Open	1H2/Y250/S	225.00
DC527	55	Black	Open	1H2/Y250/S	245.00
DC529	55	Blue	Closed	1H1/Y1.9/150	215.00
DC531	55	Natural	Closed	1H1/Y1.8/100	215.00
DC535	30	Blue	Open	1H2/Y150/S	205.00
DC532	30	Blue	Closed	1H1/Y1.9/150	165.00
DC534	30	Natural	Closed	1H1/Y1.9/150	175.00
DC538	15.5	Blue	Open	1H2/Y65/S	105.00

### ACCESSORIES

Model No.	Description	Price /Each
DA019	2" Buttress Coarse Thread	6.99
DA020	2" NPS Fine Thread	6.09
DC571	Polyethylene Drum Lever Latch for 55 US Gal. Drum	21.90
DC572	Polyethylene Drum Lever Latch for 30 US Gal. Drum	25.10

## POLYETHYLENE DRUMS - TIGHT HEAD

- High density polyethylene construction, can be stacked with pallets up to four high
- Maximum filling temperature of 65°C; drums should be allowed to cool to ambient temperatures before stacking
- Features 2" and 3/4" NPS fittings and manipulating handle
- Capacity is based on US Gal. readings
- Accepted for use in Canadian food processing facilities



Model No.	Capacity Gallons	Colour	Top	UN Compliance	Price /Each
DC540	15	Blue	Closed	1H1/Y1.9/160	98.90
DC542	15	Natural	Closed	1H1/Y1.9/160	98.50

## RECTANGULAR POLY TIGHT HEAD CONTAINERS

- Suitable for storing and shipping liquid, granular and semi-solid chemicals, detergents, petroleum products, food products, pharmaceuticals and acids
- Recessed handle and anchoring
- Protruding stabilizers prevent tipping
- Ventcaps are included but leakproof screw caps are extra
- Container capacity: 20 litres
- Dimensions: 11 1/2" L x 9 1/2" D x 9 3/4" H



Model No.	Mfg. No.	Description	Opening mm	Price /Each
DC163	158	Yellow Container Only*	60	28.90
DA684	240	Natural Container Only*	60	28.90
DA685	284	Security Cap	60	4.39

\*Security cap not included.



# DRUMS

## UNIVERSAL POLY-DRUM FUNNEL™

- Patented scalloped design, high sidewall and bung fitting holders
- For use with 30 and 55 US gallon drums
- Funnels nest for compact shipment
- Safety funnel includes a non-sparking safety bung closure with flame arrestor for use with flammable liquids
- Optional cover keeps the weather and other hazards out
- Easy installation
- **Exterior dimensions:** 26" dia. x 5 1/2" H
- **Interior dimensions:** 22" dia. x 4" H



SAH566

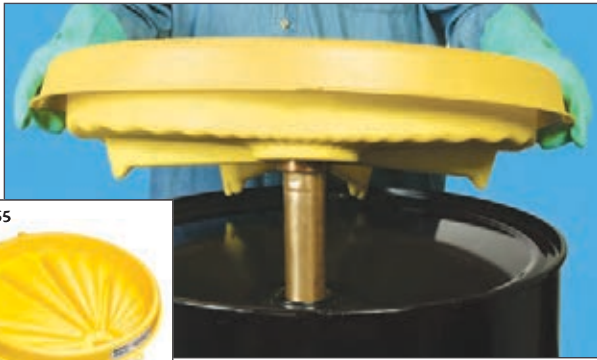

SAH565



Model No.	Mfg. No.	Description	Wt. lbs.	Price /Each
SAH565	3004-YE	Funnel	3	239.00
SAH566	3004-YE-SF	Safety Funnel	5	999.00
SAH567	3040-YE	Funnel Cover	3	269.00

## POLY-DRUM TOPPER™ COVERS

- Snaps directly onto any 55 US gallon open or closed-head drum to keep out debris and protect drum tops
- Easy installation
- **Exterior dimensions:** 25 1/2" dia. x 3 3/4" H



Model No.	Mfg. No.	Description	Wt. lbs.	Price /Each
SAQ193	3065-BK	Poly-Drum Topper™	1.5	195.00

## SAFETY DRUM FUNNELS

- Suitable for handling flammables, minimise potentially dangerous spills
- Large 10 3/4" mouth provides quick dumping
- Steel construction with 6" flame arrestor for the DA102 and 32" flame arrestor for the DA101
- Hinged cover with fusiblelink reduces spread of vapours
- FM approved



Model No.	Mfg. No.	Description	NPS"	Wt. lbs.	Price /Each
DA101	8205	32" Flame Arrestor	2	29	809.00
DA102	8207	6" Flame Arrestor	3/4	11	533.00

DA102



DA101



## DRUMS-UP™ TRAYS

### THE INCIDENTAL SPILL SOLUTION!

- Catch liquid before it reaches the floor, reducing the risk of slip and fall injuries
- Ideal for use as a drum pumping station
- Secondary containment unit features a unique geometric design covering more floor area
- Drain spout makes emptying easy

### DRUMS-UP™

- Contains drips for containers up to 55 US gallons
- Control nuisance spills from drums with a 20 US gallon capacity
- Convenient pour spout

### DRUMS-UP JR™

- Containment for 16 to 30 US gallon drums and 5-gallon pails
- 7 1/2 US gallon capacity

Model No.	Mfg. No.	Description	Dimensions Dia" x H"	Wt. lbs.	Price /Each
DA104	8091-YE	Drums-Up™	37 1/2 x 7 1/2	6	435.00
SD361	8200-YE	Drums-Up Jr.™	22 3/4 x 7 1/2	2	269.00



SD361



Drum not included

DA104



## FUSIBLE LINK SELF-CLOSING DRUM COVERS

- Convert open top 55 US gallon steel drums into fire-safe receptacles for combustible trash
- A replaceable fusible link assembly inside the cover melts at 165°F, automatically slamming the cover shut if a fire occurs in the drum
- Steel construction; solvent resistant, red baked-on-enamel finish
- Fits drums from 22 1/2" to 22 3/4" in diameter
- Weight: 10 lbs.
- FM approved

**Model No. DA097**  
**Price/Each \$376.00**



## POLYETHYLENE DRUM COVERS

- For use with 55 US gal. open head drums
- Blow molded HDPE construction
- Fits Drum Size: 55 US gal.
- Colour: Yellow
- Dimensions: 23" W x 5" H

**Model No. DC555**  
**Price/Each \$99.50**



## VAPOUR TRAP™ DRUM COVERS

- Provides safe, secure and proper disposal of hazardous waste
- Control odour and vapours, minimise access to contents, and comply with your local fire marshal
- Spring loaded, self-closing, vented opening closes after each use
- Manual latching drum cover is gasketed to seal the drum contents, designed to accept an optional padlock for maximum security
- Reduced VOC emissions keep you in compliance with EPA regulations
- Constructed of durable steel, lid is finished in chemically resistant red powder paint for extended service life
- Meets EPA 40 requirements
- Approved by FM Global
- Compliant to OSHA and NFPA 30 standards

**Model No. DC284**  
**Price/Each \$1013.00**



## GALVANIZED STEEL DRUM COVERS

- Cover drums for added protection
- The perimeter rim is beaded for safety
- Fits Drum Size: 55 US gal. (45 imp. gal.)
- Colour: Silver



Model No.	Drum Type	Price /Each
DC640	Open Head	71.50
DC639	Closed Head	63.90

## PLASTIC PAIL LINER

- Ideal for mixing and storing a variety of liquids, powders, pastes such as chemicals, adhesives, greases, paints, and more
- Seamless vacuum-formed LDPE insert
- Snap-on contoured lip prevents leakage between insert and pail wall
- Liner Type: Anti-Static
- Wall Thickness: 15 mils
- For Drum Capacity: 5 US gal (4.16 imp. Gal.)
- Height: 14"
- Diameter: 11-1/4"

**Model No. DC815**  
**Price/Each \$6.25**



## CAN TIPPERS

- Handles 5-gallon round pails
- Safety lever holds container in place
- Dispensing height of 11-1/2"
- Capacity: 75 lbs

**Model No. DC472**  
**Price/Each \$96.95**



## PORTABLE DRUM STANDS

- Designed for compact storage of 30 and 55-gallon steel and fibre drums
- Interlocking design secures stand to drum
- Enclosed fork tubes lock stand onto forks and allow for secure transportation of drums with fork or pallet truck
- Allows drums to be stacked three high
- Powder coated safety yellow for visibility
- 1500-lb. maximum capacity per stand

**Model No. DC073**  
**Price/Each \$329.00**



# DRUMS

## ACCORDION INSERTS FOR 55-GALLON DRUMS

- Made of FDA compliant materials
- Accordion pleat design adjusts to varying heights of reconditioned drums
- Formed lip grips chime of drum and stays in place during follower plate pumping



Model No.	Wall Thickness	Qty /Case	Price /Each
DC338	15 mil	20	29.99
DC340	18 mil	15	34.09

## STRAIGHT-SIDED INSERTS FOR 30 & 55-GALLON OPEN HEAD STEEL DRUMS

- Made of FDA compliant materials
- Smooth wall inserts withstand mixing and pumping applications
- Available in anti-static
- Model DC337 used for hot-fill applications to 180°F
- Model DC344 used for hot-fill applications to 280°F



Model No.	Wall Thickness	Drum Gal.	Qty /Case	Price /Each
DC336	15 mil	30	25	31.99
DC337	15 mil	55	20	32.90
DC339*	15 mil	55	20	33.90
DC344	15 mil	55	10	63.69
DC342*	18 mil	55	15	38.50
DC343	24 mil	55	15	48.59

\* Anti-static

## INSERTS FOR 5-GALLON STEEL PAILS

- Made of FDA compliant materials
- Straight-sided inserts for steel pails are ideal for small batch mixing



Model No.	Wall Thickness	Material	Qty /Case	Price /Each
DC347	15 mil	LDPE	100	7.99

## CHEMLINERS

- Formfit liner constructed from LDPE/NYLON/LDPE
- Resists chemical permeation and degradation
- Superior flex-crack and pinhole resistance for liquid applications



Model No.	Height"	Wall Thickness	Qty /Case	Price /Each
DA926	40	5 mil	100	24.39

## ULTRALINER DRUM INSERTS FOR 55-GALLON STEEL & FIBRE DRUMS

- Heavy-duty 18-mil insert with ultra thin lip for easy lid closure
- Can be used with fibre and steel drums



Model No.	Inside Dia."	Wall Thickness	Qty /Case	Price /Each
DC346	22.5	18 mil LDPE	15	34.09
DC493	22.5	24 mil LDPE	15	52.49

## FORMFIT LINERS FOR 55-GALLON DRUMS

- Cylindrical film liners are heat-sealed and made of FDA compliant materials
- Available in 40" height to fold over drum or 53" height to tie off
- Available in mil thickness of 4, 6, 8 or 10
- Available in anti-static for solvent-based applications



Model No.	Height"	Wall Thickness	Qty /Case	Price /Each
DC353	40	4 mil	100	9.89
DC494	40	6 mil	100	12.50
DC354	40	8 mil	50	13.90
DC355	40	10 mil	50	13.99
DC356	53	4 mil	100	10.90
DC495	53	6 mil	100	13.90
DC357	53	8 mil	50	15.90
DC358	53	10 mil	50	18.90
DC359*	53	8 mil	50	16.50

\* Anti-static

## HOT-FILL LINERS FOR 55-GALLON DRUMS

- Round bottom liner constructed from polypropylene will withstand fill temperature to 290°F



Model No.	Height"	Wall Thickness	Qty /Case	Price /Each
DA927	40	4 mil	100	24.39

## PAIL INSERTS & STRAINERS

### INSERT

- Seamless 14" tall tapered insert provides custom fit for plastic pail
- Average 15-mil thick
- FDA compliant materials

### STRAINER

- Heavy-duty strainer ideal for filtering liquids or holding parts for washing
- Featuring 600-micron mesh, finer mesh strainers are available



Model No.	Material	Size (Gal)	Qty/Case	Price/Each
<b>INSERTS</b>				
DC350	HDPE	5	100	8.09
DC351	LDPE	5	100	7.09
<b>STRAINERS</b>				
DC049	-	5	48	12.29
DB021	-	55	8	35.59





## BUNG NUT WRENCHES

- Fits almost any metal or plastic, male or female bung nuts or plugs
- 13" overall length
- Offset handle
- Weight: 4 lbs.

**Model No. DA638**  
Annealed Ductile Iron  
**Price/Each \$54.50**

**Model No. DA637**  
Non-Sparking,  
Manganese Bronze Alloy  
**Price/Each \$86.95**

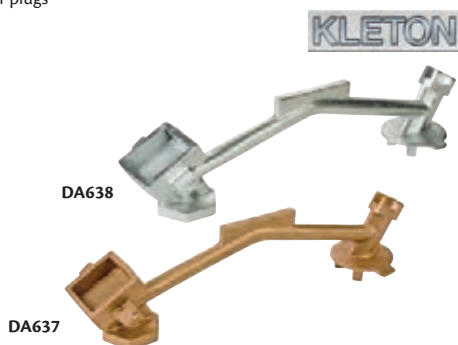

## UNIVERSAL PLUG WRENCHES

- Fits virtually all steel, plastic and fibre drum plugs
- 15 1/2" long for extra leverage and hand clearance
- For use with 3/4" and 2" pipe thread (NPT) size bungs
- Weight: 4 lbs.

**Model No. DA635**  
Solid Ductile Iron  
**Price/Each \$62.90**

**Model No. DA636**  
Non-Sparking,  
Zinc Aluminum Alloy  
**Price/Each \$149.00**



## DELUXE PLUG WRENCHES

- Non-sparking brass alloy wrench fits virtually all industrial drums including those with square or hex plugs, male or female bung nuts or plugs and fittings with lugs and crossbars
- Built-in 1 1/4" wrench for tightening faucets into drums; eliminates the need for extra tools
- Weight: 2 lbs.

**Model No. PE359**  
**Price/Each \$84.95**



## DRUM LOCKS

- Safely secure drum contents without the risk of contamination
- Reduces theft, pilfering, sabotage and prevents "cocktailing" of contents
- Made of corrosion resistant, non-sparking zinc die cast, the units easily install around the drum bung flange with no risk of cross threading
- Sold as a pair, these drum locks fit the most popular style of steel 55-gallon (200 L) drums
- Set includes 2 lip seals and 2 interchangeable lock bars

Both sets are available without or with a No.3 Master Lock® padlock



Model No.	Description	Size Lip Seal O.D.	Price /Each
DC282	Without Lock	1 x 3", 1 x 1 1/2"	110.00
DC289	With Keyed Different	1 x 3", 1 x 1 1/2"	138.00
DC291	With Keyed Alike	1 x 3", 1 x 1 1/2"	161.00



## DRUM UPENDERS

- This 40" long upender provides the necessary leverage for moving horizontal drums to a standing position
- 2 1/2" wide toe plate prevents denting of drum
- 1 1/2" hook fits over most drum heads
- Not for lowering drum
- Weight: 9 lbs.

**Model No. DA653**  
**Price/Each \$145.00**



## MANUAL DRUM DEHEADER

- Open any size and gauge steel drum quickly and easily, allowing drum recycling without the risk of fire from cutting with a torch
- Comfortable plastic hand grip
- Frame Material: Steel
- Blade Material: Steel
- Handle Length: 20"

**Model No. DC603** Drum Deheader  
**Price/Each \$161.00**

**Model No. DC607** Replacement Blade  
**Price/Each \$43.19**



## STEEL PAIL OPENER

- Designed to open and close virtually any type of steel or plastic pail
- Cast steel construction for durability
- Yellow zinc-plated finish with molded blue plastic hand grip
- Includes a special cutting tool to open sealed lids on plastic pails
- Weight: 2 lbs.

**Model No. DC041**  
**Price/Each \$58.90**



## PAIL OPENER

- For use on plastic pails/buckets
- Made from durable plastic (nylon)
- Ergonomic and easy to use
- Non-sparking
- Rustproof
- Frame Material: Polymer
- Handle Length: 5"
- Colour: Black

**Model No. DC824**  
**Price/Each \$8.95**



## DRUM BUNG SOCKET

- Fits 3/4" and 2" bung sizes



DC665



DC666



Model No.	Mfg No.	Description	Price /Each
DC665	BUNG-S-B1	3/8" Drive, Non-Sparking Bronze Alloy	119.00
DC666	BUNG-S-S1	3/8" Drive, Zinc-Plated Drum Socket	55.50
DC667	BUNG-S-S2	1/2" Drive, Zinc-Plated Drum Socket	55.50
DC668	BUNG-S	3/4" Drive, Zinc-Plated Drum Socket	55.50

# DRUM EQUIPMENT

## GRADUATED DRUM GAUGES

Combination gauge and faucet permits uninterrupted draining of drum contents with gauge in place. Mounts through 3/4" bung hole. Constructed of heavy gauge glass in plated steel body with Buna-N seals. Weight: 3 lbs.



**WESCO**

Model No.	Description	Price/Each
DA064	Gauge only	259.00
DA065	Gauge with faucet*	300.00

\* Zinc Die Cast Faucet FM approved for viscous liquids only; no flame arrestor.

## DRUM FILL GAUGES

Provides a low cost solution to over-filling drums. When the drum is almost full, the indicator "Pops-up" to warn you. Fits in standard 3/4" bung opening. Bright red and yellow molded polyethylene. 5" length. Weight: 0.20 oz.



**Justrite**

Model No.	Price/Each
DA066	38.10

## SAFETY DRUM FUNNELS

- Suitable for handling flammables
- Large 10 3/4" mouth provides quick dumping
- Steel construction with 6" flame arrestor for the DA102 and 32" flame arrestor for the DA101
- Hinged cover with fusible link reduces spread of vapours
- 2" NPS/NPT
- FM approved



**Justrite**

Model No.	Description	Wt. lbs.	Price /Each
DA102	6" flame arrestor w/funnel	7.5	533.00
DA101	32" flame arrestor w/funnel	12	809.00

## HORIZONTAL BRASS VENTS

- Horizontal vents are for use with drums in the horizontal pouring position
- Automatically relieves pressure at 5 PSI
- Flame arrestor prevents sparks and flame from igniting contents
- Manual vacuum relief by lifting and rotating the valve stem
- Maximum flow of 220 CFM at 20 PSI
- Fits 2" NPS bung in steel or plastic drums

Model No. PE362  
Price/Each \$71.15



**KLETON**

## VERTICAL VENTS

FM approved vents are for use with drums in the upright position. Valve automatically opens to relieve internal pressure at 5 PSI. Automatic vacuum relief permits 4 GPM flow through 3/4" faucet. Fits 2" NPT bung opening.



Model No.	Description	Application	Wt. lbs.	Price /Each
DA607	Brass Vent	Petroleum-Based	0.5	208.00
DA605	Non-metallic Vent, Cad-plated flame arrestor	Petroleum-Based	0.5	121.00
DA606	Non-metallic Vent, Stainless steel flame arrestor	Chlorinated Solvents	1.0	176.00

## STEEL STACKABLE DRUM RACK

- Steel drum rack has four-way fork truck access for ideal operation
  - Do not stack more than four racks high for safety and maximum efficiency
  - Features durable construction for added strength and long life
  - Includes bolt together assembly and hardware for optimal results
  - Drum Capacity: 2
  - Capacity: 1600 lbs.
  - 45-1/2" W x 29-7/8" D x 12-3/4" H
  - Accepts: 55-Gallon Drums
  - Cradle Steel Thickness: 1/4"
  - Colour: Yellow
- Model No. DC826  
Mfg. No. DRUM-RACK-2  
Price/Each \$309.00

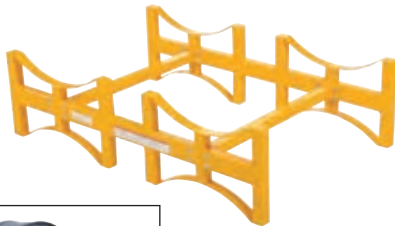

**Vestil**



## TAKING THE STRESS OUT OF SPILLS

**ZENITH**  
Safety Products



## SELF-CLOSING FAUCETS

- For non-flammable liquids only
- No flame arrestor
- 3/4" pipe thread
- Can be padlocked closed
- Natural die cast finish

Model No. PE365  
Price/Each \$30.95



KLETON

## SELF-CLOSING FAUCETS W/SCREEN

- Flame arrestor safety faucet
- Standard 3/4" tapered pipe thread
- Can be padlocked closed
- Natural die cast finish

Model No. PE364  
Price/Each \$36.25



KLETON

## SELF CLOSING GATE VALVES

- For use with viscous non-corrosive fluids heavier than SAE30 motor oil
- Heavy-duty brass construction
- Self-closing PTFE blade has fast, positive shut off when handle is released
- 4 1/2" wide handle
- Wide opening permits maximum flow
- Fits 2" bung in steel or plastic drums
- Weight: 7 lbs.

Model No. PE363  
Price/Each \$199.00



KLETON

## MOLASSES GATE DRUM FAUCET

- Model 65-75 fits bung with 2" (5.08 cm) National Pipe Thread (NPT)
- Durable construction with steel handle, cast gray iron body
- Brass slide plate stays open until shut off
- Can be padlocked
- Dispensing I.D. is 1.75" (4.45 cm)
- Use with room temperature liquids
- Will handle liquids up to a maximum of 130 degrees F (54 C)
- This faucet is NOT self-closing
- NOT for use with flammable liquids
- Morse drum faucets are NOT considered "food grade"



MORSE

Model No.	Mfg. No.	Material	NPT Inlet Size"	Gate Valve Type	Price /Each
DC835	65-20	Cast Iron	2	Standard Gate	159.00

## FAUCETS

- Approved for use with oils, flammables and non-flammable
- Internal flame arrestor
- Teflon® gasket
- FM approved
- Self closing faucet



DA043



DC404

Model No.	Material	NPT Inlet Size"	Price /Each
DC404	Brass	3/4	95.80
DA043	Stainless steel	3/4	488.00

## POLYETHYLENE DRUM FAUCETS

- Produced from FDA-approved material
- Includes 3 EPDM sealing gaskets: thin, medium, thick
- NPT Inlet Size: 2"



DC631

WESCO

Model No.	Includes	Price /Each
DC630	-	34.89
DC631	Level Gauge Port, Pail Hook	38.39

Bonding and grounding wire assemblies dissipate the static electricity generated during the transfer of flammable liquids. Various clamp styles available to work with different containers. Required by OSHA for fluids with a flashpoint below 140°F.

LIND EQUIPMENT

## COILED GROUNDING CLAMPS

- Vinyl coated 1/8" cable resists corrosive environments to give years of service
- Unit is self-coiling to retract when not in use
- Includes one heavy duty REB clamp and one 1/4" terminal end



Model No.	Description	Price/Each
DA632	5' coil	83.50
DA628	10' coil	95.50
DA777	15' coil	109.00
DB029	20' coil	125.00
DA778	30' coil	139.00

## HEAVY-DUTY AVIATION STATIC GROUNDING HAND CLAMPS

- Aviation industry standard for bonding and grounding aircraft and refueling vehicles
- Ideal for attaching to landing gear, posts, ground balls, ground rods and other curved, unpainted surfaces
- Cast aluminum construction with plated steel jaws
- Clamp opens to 13/16" and can take up to #6 cable
- Weight: 0.3 lbs.

Model No. DC488  
Price/Each \$62.50



## HEAVY-DUTY HAND CLAMPS

- Grounding clamp for flammable drum loading
- Die cast aluminum body, stainless steel points and 55-lbs. spring enable clamp to consistently make positive metal to metal ground connection
- Accommodates all cable up to 5/32"; connection is made in clamp's handle held by dual Allen screw contacts

Model No. DA633  
Price/Each \$61.50





# DRUM EQUIPMENT

Bonding and grounding wire assemblies dissipate the static electricity generated during the transfer of flammable liquids. Various clamp styles available to work with different containers. Required by OSHA for fluids with a flashpoint below 140°F.



## HEAVY-DUTY BONDING & GROUNDING WIRE ASSEMBLIES

### TWO HAND CLAMP CONNECTORS



Model No.	Wire Length"	Wire Description	Price/Each
DA735	36	Stainless Steel Cable	119.00
DA736	72	Stainless Steel Cable	119.00
DA737	120	Stainless Steel Cable	125.00

### HAND CLAMP & 5/16" TERMINAL CONNECTORS

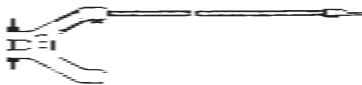

Model No.	Wire Length"	Wire Description	Price/Each
DA738	36	Stainless Steel Cable	67.50
DA739	72	Stainless Steel Cable	68.90
DA740	120	Stainless Steel Cable	75.50

## LIGHT-DUTY BONDING & GROUNDING WIRE ASSEMBLIES

### ALLIGATOR CLIP & 3/4" BEAM CLAMPS

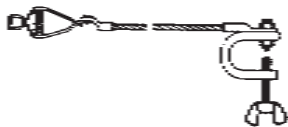

Model No.	Wire Length"	Wire Description	Price/Each
DA621	36	Stainless Steel	39.90
DA750	72	Stainless Steel	43.50
DA751	120	Stainless Steel	47.50

### TWO ALLIGATOR CLIPS



Model No.	Wire Length"	Wire Description	Price/Each
DA622	36	Stainless Steel	38.50
DA754	72	Stainless Steel	41.90
DA755	120	Stainless Steel	45.90
DA756	36	PVC Coated	43.90
DA757	72	PVC Coated	47.50
DA758	120	PVC Coated	52.90

### ALLIGATOR CLIP & 5/16" TERMINAL CONNECTORS



Model No.	Wire Length"	Wire Description	Price/Each
DA759	36	Stainless Steel	31.50
DA760	72	Stainless Steel	35.50
DA761	120	Stainless Steel	39.50

## STATICSURE MONITORING DEVICES

- Essential safety device for any business that transfers flammables
- Unlike standard bonding and grounding clamps, the StaticSure alerts the operator as to whether a static bond has been achieved. If a proper connection has not been achieved, a bright red LED light will flash on the device
- StaticSure provides that extra level of assurance to an organization in that they are complying with the Canadian Fire Code while simultaneously providing their employees with a safer working environment
- Includes mounting clips for wall mount applications
- Available as a stand-alone unit, or can be mounted to a cord reel



Model No.	Description	Cord Reel Included	Dimensions W" x D" x H"	Wt. lbs.	Price /Each
DC497	One 20' 18/2 coiled SOW cord with GAT-PIP clamp & one 2' 18/2 straight SOW cord with GAT-PIP clamp	No	66 9/10 x 3 x 2 1/10	5	1375.00
DC457	One 20' 18/2 SOW cord with GAT-PIP clamp & one 2' 18/2 SOW cord with lugs	No	66 9/10 x 3 x 2 1/10	5	1199.00
DC498	One 20' 18/2 SOW cord with REB-IP clamp & one 2' 18/2 SOW cord with REB-IP clamp	No	63 9/10 x 3 x 2 1/10	4	1219.00
DC459	One 20' 18/2 SOW cord with REB-IP clamp & one 2' 18/2 SOW cord with lugs	No	63 9/10 x 3 x 2 1/10	4	1145.00
DC480	50' 16/3 SOW cord with REB-IP clamp & 2' 16/3 SOW cord with lugs	Yes	13 4/5 x 12 x 3	31	1969.00
DC481	50' 16/3 SOW cord with GAT-PIP clamp & 2' 16/3 SOW cord with lugs	Yes	13 4/5 x 12 x 3	33	2109.00
DC482	100' 16/3 SOW cord with REB-IP clamp & 2' 16/3 SOW cord with lugs	Yes	14 1/2 x 9 1/5 x 15	42	3445.00
DC483	100' 16/3 SOW cord with GAT-PIP clamp & 2' 16/3 SOW cord with lugs	Yes	14 1/2 x 9 1/5 x 15	43	3559.00

## HEAVY-DUTY STATIC GROUNDING HAND WIND REELS

- Ruggedly constructed reels are an economical alternative to automatic retracting reels
- Fewer parts to maintain, allowing for years of trouble free service
- Highly compact storage of a wide range of cable lengths
- 100A solid copper alligator clip can be substituted with our heavier duty REB clamp when using this reel in outdoor areas or with painted, dirty or rusty surfaces
- Cable Type: Yellow Hyrel Coated Plated Steel



Model No.	Cord Length (feet)	Cable Size	Dimensions W" x D" x H"	Wt. lbs.	Price /Each
DC489	50	3/32" I.D. coated to 5/32" O.D.	9 1/5 x 5 3/10 x 9 7/10	9.8	659.00
DC490	75	3/32" I.D. coated to 5/32" O.D.	9 1/5 x 5 3/10 x 9 7/10	10.3	719.00
DC491	100	3/32" I.D. coated to 5/32" O.D.	9 1/5 x 5 3/10 x 9 7/10	10.8	765.00

## RETRACTABLE GROUNDING WIRES

- Replace loose/tangled grounding cables with compact retractable reels
- For use where a discharge of static electricity could cause a spark and subsequent explosion
- Holds 20' to 100' of cable
- Positive latching mechanism holds cable at any length
- A slight pull on the cable releases the mechanism causing retraction
- Bearing surfaces are permanently lubricated
- Alligator clip included
- Heavy-duty reels have robust, weatherproof construction and coated cables
- Functions under extreme environmental conditions
- Available with REB clamp for when attaching clamp to painted, dirty or rusty surfaces



DA609

Model No.	Cable Description	Length'	Wt. lbs.	Price/Each
DA609	Light Duty	20	3.5	445.00
DA610	Light Duty	50	5.5	585.00
DB025	Heavy-Duty Open Style	50	12	865.00
DB026	Heavy-Duty Open Style	75	17	1009.00
DB027	Heavy-Duty Open Style	100	22	1155.00



DB025

## STATIC GROUNDING CLAMPS

- Cast aluminum construction, available with stainless steel points or brass "cup" points
- Large, heavy-duty clamp designed for grounding railcars, tanker trucks, barges and large vans
- Equipped with a quick release harness, which is designed to open the clamp automatically in case the operator forgets to remove the clamp prior to the vehicle's departure
- Isolated points available for connection to static monitoring system
- Clamp opens to 1 1/2"

Model No.	Description	Configuration	Wt. lbs.	Price/Each
DC484	Stainless Steel Points	3 Points	0.7	199.00
DC485	Stainless Steel Points	1 Isolated Point	0.7	239.00
DC486	Brass Cup Points	1 Isolated Cup Point	0.7	249.00
DC487	Brass Cup Points	2 Isolated Cup Points	0.7	259.00



## HYDRA-LIFT DRUM HANDLERS

- A safe way to lift, move, tilt and drain 45 imp. gal./55 US gal. drums
- Manual control; pump-handle lifts drum, maximum extension is 45 strokes
- Hand crank controls tilt angle of drum up to 360° in either direction for controlled pouring of contents, chain wheel controls tilt for 72" and higher lift models
- 800 lbs. full drum capacity; 500 lbs. half-full capacity
- Rugged, heavy-duty welded frame; 8" polyolefin wheels and 4" swivel casters; screw-down floor lock
- Power lift and power tilt with a choice of motors is optional
- 60" and 72" manual lift and tilt units ship partially disassembled
- Powered models eliminate the manual effort of drum raising and tilting; increases productivity and safety
- Optional MORStop™ tilt brake holds drum tilt position constant even when tension from the pull chain is removed

**MANUAL LIFT** - For the 60" dispensing height unit, the tilt function is controlled by a hand crank. The 72" and 96" tilt control is with a chain wheel.

**POWER LIFT** - Moving valve handle to up, down or hold position controls drum height; 15 - 20 seconds lifting time.

**POWER LIFT & TILT** - One valve controls lifting, another controls tilt angle. Ideal when hand crank or chain drop is out of reach.

**MORSE**

**MORStop™ Tilt Brake**



Dispensing Height"	H"	L"	R"	O.D."	I.D."
60	55	60	12	44	37
72	55	60	6	44	37
96	69	72 1/2	4	49	42

Dispensing Height			Description	60" Price /Each	72" Price /Each	96" Price /Each
60"	72"	96"				
Model No.	Model No.	Model No.				
DA138	DA143	DA153	Manual hydra lift and tilt	5585.00	5629.00	6075.00
DA139 <sup>†</sup>	DA144 <sup>†</sup>	DA154 <sup>†</sup>	Hydra lift c/w air power lift and power tilt	10209.00	10209.00	10615.00
DA141	DA146	DA156	Hydra lift c/w air power lift and manual tilt*	8299.00	8299.00	8595.00
OPTION						
DC077	MORStop™ Tilt Brake Option					479.00

\* Filter, regulator and lubricator not included \*\* Battery and charger included

<sup>†</sup> MORStop™ tilt brake option not needed

## PORTABLE ROTATORS

- Efficiently mixes the contents of closed steel drums
- Eliminates the danger of spills and contamination
- Built-in retractable loading bar allows for tipping up to 500-lb. drums
- Provides efficient handling of liquid loads up to 500 lbs. at any drum speed
- Dry load capacity: 350 lbs. at 15 RPM, 300 lbs. at 20 RPM and 250 lbs. at 24 RPM
- Standard motor is 1/2 HP, 60 Hz, 115 V, TEFC single phase; comes with switch and plug
- Can handle steel drums from 6" to 28" in diameter, and up to 40" in length
- Air and explosion proof motors are available upon request



**MORSE**

Model No.	Mfg No	Description	Wt. lbs.	Price /Each
DA572	201/20-1	Standard Rotator*	176	4205.00
DA574	201VS-1	Variable Speed Rotator**	183	4989.00

\* Standard factory set speed of 20 RPM unless otherwise specified.

\*\* Drum speed: 15 to 24 RPM

## MORCINCH™ OPTIONS & ACCESSORIES

### TOP RIM CLAMP

- Can be added to most of our Morse drum lifting equipment
- Grips the upper rim of your drum to prevent it from slipping through the drum holder
- Add this option to handle a 55 gallon (208 L) rimmed plastic drum
- Can also be used with a rimmed fiber or steel drum
- Weight: 11 lbs.

**Model No. DC278**  
**Mfg No. 4560-P**  
**Price/Each \$439.00**

### BRACKET ASSEMBLY

- Can be added to most of our Morse drum lifting equipment
- Add this option to handle your fibre drums or rimless plastic drums
- The bracket braces the top and bottom of your drum to prevent it from slipping in the holder
- Adjustable to handle drums from 31" to 39" tall
- Weight: 20 lbs.

**Model No. DC279**  
**Mfg No. 4556-P**  
**Price/Each \$409.00**

### DIAMETER ADAPTORS

- Can be added to most of our Morse drum lifting equipment
- Designed to fit a smaller diameter drum and it easily fits inside the drum holder
- No tools required to install
- Adaptor for 18 1/2" to 19" diameter drums
- Weight: 24 lbs.

**Model No. DC280**  
**Mfg No. 55/30-19**  
**Price/Each \$325.00**



**DC278**  
**Top Rim Clamp**

**MORSE**



**DC279**  
**Bracket Assembly**



**DC280**

**MORCINCH™**

# DRUM EQUIPMENT

## FORK MOUNTED DRUM LIFTERS

- Allows operator to raise, transport, tip and drain loaded drums without leaving their seat
- Geared design with pull chain or battery powered with pendant for controlled dispensing of open and closed head steel drums up to 2000 lbs.
- Manipulation of pull chain on geared type models for 360° rotation
- Attaches easily to truck by sliding onto forks and tightening screw locks
- No electrical or hydraulic connections to truck are needed
- 6-1/2" W x 26-5/8" D x 2-1/2" H fork pockets; inside width between forks must be 25"
- Options are available to handle plastic, fibre, and steel drums
- 22 1/2" diameter

Model No.	Mfg No.	Drum Size Gallons	Tilt Type	Full Drum Cap. lbs.	Half Drum Cap. lbs.	Wt. lbs.	Price /Each
DA133	285A	45 Imp. /55 US <sup>1</sup>	Geared	800	500	149	1845.00
DA135	285A-HD	45 Imp. /55 US	Geared	1500	800	171	2065.00
DA134	285A-GR	45 Imp. /55 US	Geared	2000	1000	273	4115.00

**Note:** Battery powered option available



DA133

Controlled pouring up to 2000 lbs.



## DRUM LIFTERS

Safely transport, position and drain open and closed head steel drums. Simply attach the lifter on hook of chain block, monorail or crane, cinch saddle around drum, and then raise to the required height and position. Ratchet mechanism securely tightens saddle to drum. Choice of manual or geared models.

### MANUAL TILT

- Ideal for low level pouring and dumping operations
- 800 lbs. full drum capacity, 500 lbs. half drum capacity
- Tilt lock on each side of hanger frame is used to secure drum in a vertical or horizontal position

Model No.	Mfg No.	Drum Size	Price/Each
DA199	85A	45 imp. gal./55 US gal. steel; 22 1/2" dia.	639.00
DA200	85I & 55/30-19	25 and 45 imp. gal./55 US gal. steel; 18 1/2" - 19" and 22 1/2" dia. Includes DC280	1109.00
DA201	85C	21" - 23" dia. fibre or steel	669.00

**Note:** Options and accessories are available



DA199

### GEARED TILT

- Accurate pouring from any height
- Handles drums up to 2000 lbs full drum capacity
- Rotation of drum is controlled by 12' chain loop
- Optional MORStop™ tilt brake holds drum tilt position constant even when tension from the pull chain is removed



Model No.	Mfg No.	Drum Size	Full Drum Cap. lbs.	Half Full Cap. lbs.	Wt. lbs.	Price /Each
DA121*	185A	45 imp. gal./55 US gal. steel; 22" - 23 1/2" dia.	800	500	98	1465.00
DA124*	185A-HD	45 imp. gal./55 US gal. steel; 22 1/2" dia.	1500	800	114	1729.00
DA123**	185A-GR	45 imp. gal./55 US gal.; 22 1/2" dia.	2000	1000	206	3765.00

### OPTION

DC077	3900-P	MORStop™ Tilt Brake Option	479.00
-------	--------	----------------------------	--------

\* Chains can be guided into locking slots to hold the drum's position, allowing the operator to let go

\*\* Worm gear speed reducer on DA123 tends to let drum stay where it is stopped, removing the need for the optional tilt brake



DA124

## DRUM CONES

- Used to dispense dry materials
- Replaces drum lids with a cone and clamp collar to reduce dust and keep material clean
- Clamp collar is included
- Start and stop dispensing with a slide gate or iris valve
- Slide gate and iris valve openings are 6"
- To be used on fibre or steel drums with a 15 1/2" to 23 1/2" diameter
- Cone opening has a 45° angle and is made of regular steel
- Also available in stainless steel and other sizes



DC276

DC277



Model No.	Opening	Outside Rim Dia"	Wt. lbs.	Price /Each
DC276	Slide Gate	23 3/8	50	1835.00
DC277	Iris Valve	23 3/8	50	3579.00



## VERTICAL LIFT DRUM POURERS

- Allows for easy lifting, tilting and draining of drums up to 106" high
- Scale equipped models allows users to accurately monitor the weight of drum while pouring
- Digital scale displays weight in 0.1 lb. increments with an accuracy of +/-0.2%
- Available in manual hydraulic lift or AC powered lift
- Tilting operation manually controlled on all models
- Non-scale / non-powered lift models are safe for use in hazardous environments
- Two 6" polyolefin swivel casters and two 8" polyolefin wheels make this unit easy to manoeuvre
- Built-in PVC chain cover to handle both steel and fibre drums 22" to 23 1/2" O.D. up to 800 lbs.

Stainless steel available.  
Call us with your specs.



DC085



Model No.	Mfg No.	Lift Height"	Tilt Function	Lift Function	Scale Equipped	Wt. lbs.	Price /Each
DC085	510	60	Manual	Manual	No	590	9829.00
DC086	520	106	Manual	Manual	No	858	11325.00
DC083	515-N	60	Manual	Manual	Yes	791	27525.00
DC084	525-N	106	Manual	Manual	Yes	936	28965.00

## DRUM LIFTERS

- Designed for steel, plastic and fibre drums with diameters between 22" to 23-1/2" and heights between 23" to 38"
- Attaches to a monorail, crane or chain block and transports loaded drums in the upright position
- Drum is secured into the saddle by a web strap and ratchet mechanism
- The saddle, as well as the support bar at the bottom of the drum ensure that drums will be transported safely, restraining the drum from sliding out
- Accepts diameter adaptors for smaller drums
- Drum Capacity: 30 - 55 US Gal. (25 - 45 Imperial Gal.)
- Lifting Capacity: 1000 lbs./454 kg

Model No. DA935  
Mfg No. 86  
Price/Each \$739.00



DA935



### TYPE 304 STAINLESS STEEL

Model No. DC644  
Mfg No. 86-SS  
Price/Each \$3529.00

## PAILPRO™ PAIL LIFTER

- Manually centre lifter on top of your drum and adjust it to pail width
- Design allows for quick, gentle loading; pail stays upright during lift
- Lifts steel or plastic pails 11"-15" rim diameter
- Drum Capacity: 5 US gal. (4.16 Imperial Gal.)
- Lifting Capacity: 1000 lbs./454 kg
- Drum Type: Steel, Plastic

Model No. DC643  
Mfg No. 92-5  
Price/Each \$499.00



## TRIPLE TRUCK - LIFTING TRUCK

- Handles most standard rim 30, 55, 85 US gal. steel, poly and fiber drums
- Manual winch with auto brake
- Carriage lock easily locks carriage in place at any position
- Easy load rollers assist loading onto a truck bed

### FRAME ONLY

- Low profile 3" debris deflecting neoprene swivel casters
- 10" x 2 3/4" poly hub solid rubber wheels
- Wheel lock-pedal activated
- Lever operated outrigger adjustment 3 positions
- Outrigger angle can be changed even under full load

### ADJUSTABLE FORKS

- Size: 3" W x 26 3/4" L

### PLATFORM

- Size: 21 1/4" W x 28 1/8" L

### HOW TO ORDER:

1. Purchase basic frame (LT662)
2. Select lifting attachment:  
Gator Grip (LT663)  
Adjustable Forks (LT664)  
Slip-on Platform (LT665)



LT662  
Frame



LT663  
Gator Grip®



LT664  
Adjustable Forks



LT665  
Platform



Model No.	Description	Lowered Height"	Lift Height"	Capacity lbs.	Wt. lbs.	Price /Each
LT662	Frame	-	-	750	357	4329.00
LT663	Gator Grip®	28 3/4	69	750	32	1809.00
LT664	Adjustable Forks	4	62	750	30	234.00
LT665	Platform	5	62 1/8	750	6	488.00

## CHAIN SLING

- Chain Grade: Grade 80
- Jaw Opening: 27"
- Breaking Strength: 4 tons
- Rate for 0 to 60 degrees lifting angles only
- Working Load Limit: 2000 lbs./907 kg

Caution: Never exceed work load limit

Model No. LU560  
Price/Each \$236.00



VANGUARD STEEL LTD.

# DRUM EQUIPMENT

## GATOR GRIP™ FORKLIFT ATTACHMENTS FOR DRUM HANDLING

- Handles steel, plastic and fibre drums
- Patented Auto Grip lock automatically locks the jaws closed, even over rough terrain
- Adjustable for 30, 50 and 80 US gallon drums
- T-handles fasten safety to any forklift
- Can be used with open or closed head drums
- Capacity: 1000 lbs. per grip
- **Applications:** Shipping, receiving, loading, racking and palletizing



Model No.	Mfg No.	Description	Overall Dimensions W" x D" x H"	Wt. lbs.	Price /Each
DC268	240091	Single Drum Handler	28 x 34 x 34	126	2169.00
DC269	240092	Dual Drum Handler	33 1/4 x 34 x 34	208	3989.00

## MOBILE DRUM KARRIERS

- Transports, rotates, tilts and drains fully loaded drums up to 800 lbs.
- Easy to operate
- Drum can be raised to a floor clearance of 5 1/8" to 11 1/2", automatically sets lock which prevents unintentional lowering
- Tilt lock on each side of unit keeps drum in desired position
- All-welded steel construction; 8" polyolefin wheels and 4" swivel caster for easy manoeuvrability
- Weight: 97 lbs.



Model No.	Mfg No.	Drum Size	Price /Each
DA189	80A	55 US gallon steel; 22 1/2" dia.	1465.00
DA190	80APS	55 US gallon plastic and steel; 22 1/2" - 24" dia., 34" - 36" H	1525.00

## GATOR GRIP™ ERGONOMIC DRUM HANDLERS

- Handles steel, plastic and fiber drums
- Patented Auto Grip lock automatically locks the jaws closed, even over rough terrain
- Ergonomic solution for lifting, transporting and placing drums on standard pallets or spill pallets
- The jaw clamp is spring loaded and can hold any 3/16" or higher drum rim
- Adjustable for most standard 30, 55 and 85 US gallon drums
- Allows a 45 imp. gal./55 US gal. drum to be raised 20" above the floor
- Rolls smoothly on swivel casters which provide easy steering and include a floor lock
- Overall Dimensions: 34 1/2" L x 36" W (legs retracted), 37" L x 41" W (legs extended)
- Capacity (Legs Retracted): 650 lbs.
- Capacity (Legs Extended): 1100 lbs.
- Weight: 356 lbs.

**Model No. DC270**  
**Mfg No. 240150**  
**Price/Each \$5149.00**



## TILT & POUR DRUM PALLETISERS

- Designed to lift and pour 45 imp. gal./55 US gal. steel drums with ribs up to 26" high, when held in the horizontal position and can move drums on and off pallets
- Can lift drums 20" above the floor in an upright position
- Compatible with drums that have a 22 1/2" - 23 1/2" diameter between the ribs\*
- Allows manual drum rotation of 360° in either direction
- Palletiser locks in either vertical or horizontal position, to prevent spills or to dispense
- Capacity: 800 lbs.



Model No.	Mfg No.	Description	Wt. lbs.	Price/Each
DC271	82A	Drum Lifter/Palletiser/Manual Lift	497	6759.00

\*Diameter adaptors are available for smaller drums

## DRUM SPOTTERS

- Moves drums to and from pallets easily across floors, effectively and efficiently
- Designed for 45 imp. gal./55 US gal. steel or plastic drums with various rims and most fibre drums with clamp-on lids in a size range of 22 to 23 1/2" dia. and 34 to 36" high, weighing up to 800 lbs
- Features two lifting hooks which slide under the top rim of drum
- Handle provides adequate leverage to lift heavy drums
- Base has built-in counterweight for stability
- Features two 6" polyolefin load wheels and two 4" rear swivel casters for easy steering

### FEATURES:

- Simple to operate
- Compact
- Holds drums upright
- No power truck required
- Self-supporting
- No balancing required



Model No.	Mfg No.	Lifting Capacity lbs.	Max. Pallet Height"	Wt. lbs.	Price /Each
DA933	81	800	6	245	2369.00

## DRUM & OVERPACK LIFTER

- Drum Lifter is designed to lift and transport a standard 55 US gal. steel drum 22.5" in diameter
- Drum lifter can also lift an 85 US gal. overpack or salvage drum 26" in diameter
- Drum lifter can be used on closed "tight" head drums type with head intact, or with open head drums with lid securely clamped in place
- The broad faced grippers spread holding force to minimize pressure on drum
- Unit is load tested at the factory at 125% of rated capacity as per ASME B30.20
- Lifting Capacity: 1000 lbs./454 kg

**Model No. DC608**  
**Mfg No. 91**  
**Price/Each \$355.00**



## AUTOMATIC VERTICAL DRUM LIFTERS

- Lifts and transports closed steel drums easily and effectively
- Unit grips automatically; releases only when drum is set down
- Operator does not have to be at pick up or drop points
- 45 imp. gal./55 US gal. model is available in standard steel or type 304 stainless steel construction
- Capacity: 1000 lbs.



Model No.	Lifts Drum Size Gallons	Construction Material	Wt. lbs.	Price /Each
DC091	30 US	Steel	45	685.00
DA203	55 US	Steel	46	639.00
DC092	55 US	Stainless Steel	46	1819.00
DC093	85 US	Steel	59	1105.00



## AUTO-GRIP DRUM LIFTERS

- Easy, no-tilt lifting of rimmed steel drums
- Self-energizing: the heavier the load, the tighter the grip
- Attaches to any hoist, crane or forklift using single fork hook attachment
- Heavy duty, annealed, ductile iron construction
- Large curved foot at bottom of stabilizing arm prevents drum damage
- Capacity: 3000 lbs.

**Model No. DA226**  
**Mfg No. 40001**  
**Price/Each \$382.00**



## DRUM LIFTER

- Universal drum lift can lift 30 US gal. to 85 US gal. drums
- Lifts steel or plastic drums 18"-26" rim diameter
- Lifts fibre drums 18.5"-23" rim diameter
- Not intended for use with plastic overpack drums
- Lifting Capacity: 1000 lbs./454 kg.

**Model No. DA876**  
**Mfg No. 92**  
**Price/Each \$469.00**

### STAINLESS STEEL

**Model No. DC094**  
**Mfg No. 92-SS**  
**Price/Each \$1295.00**



## HORIZONTAL DRUM LIFTING HOOKS

- Horizontally lifts 45 imp. gal./55 US gal. steel drums, 34"-36" long
- Alloy steel lifting ring, steel rods, malleable iron hooks
- Capacity: 1000 lbs.

**Model No. DC449**  
**Price/Each \$52.75**

- Spark resistant lifting hook is made of stainless steel with aluminum bronze lifting hooks for safe handling
- Capacity: 1000 lbs.

**Model No. DA163**  
**Price/Each \$325.00**



## POLYESTER DRUM SLINGS

- Securely and economically lifts steel, plastic and fibre drums from 12" to 24" in diameter
- Ideal for use with a forklift truck
- Compact size of slings allows it to be stored in truck until it's needed
- Reduces drum damage which occurs when using steel handlers
- 2" x 10' endless ratchet strap tightens the reinforced polyester lifting belt around the body of the drum
- 4" x 6' double ply tie down web slips easily over the truck forks
- Capacity: 1000 lbs.

**Model No. DC470**  
**Price/Each \$180.00**

**Note:** Open ratchet fully when installing sling



## MULTI-PURPOSE OVERHEAD DRUM LIFTER WITH WRENCHES

- Simple three-arm design allows for safe lifting of 30 to 55 US gallon closed head steel, plastic and fiber drums with top lips
- Each removable arm also functions as a wrench for use on different drum plugs, faucets, and rim ring bolts
- Lifts of drums up to 800-lb. capacity
- Powder coat finish for durability

**Model No. DC095**  
**Price/Each \$289.00**

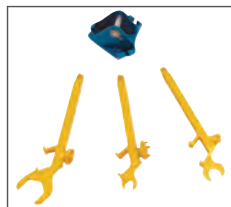

## OPEN HEAD DRUM LIFTERS

- Quick and easy attachment and removal
- Suitable for use with standard steel or poly drums with at least a 3/16" chime
- Lifting arms are adjustable to work with most 45 imp. gal./55 US gal. or 30 US gallon drums
- Attaches to any hoist, crane or forklift using single fork hook attachment
- 3-point contact of the lifting arms minimizes deformation
- Also works on closed head drums
- Capacity: 1000 lbs.

**Model No. DC420**  
**Mfg No. 240038**  
**Price/Each \$475.00**

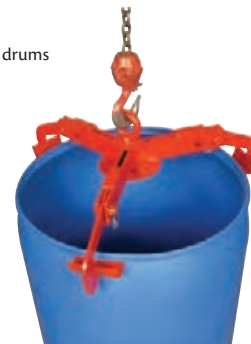



# DRUM EQUIPMENT

## STEEL DRUM GRABBERS

- Lift and transport one 45 imp. gal./55 US gal. steel drum without the fork truck driver leaving his seat
- No risk of drum slipping since handler grips under rim of drum or rolling hoops
- Heavy gauge grabber slides onto truck forks and is locked with two turn down screws



DC424

KLETON

Model No.	Description	Fork Pocket Inner Dia. W" x H	Capacity lbs./Drum	Wt. lbs.	Price /Each
DC424	Single Drum Grabber	5 1/2 x 2	1000	121	590.00

## POLY DRUM LIFTERS

- Patented fork truck attachment for handling most 45 imp. gal./55 US gal. and 30 US gallon poly drums
- Fork truck driver does not have to leave cab to engage or disengage drum
- Suited for poly drums that have at least a 3/16" top lip (chime)
- Fork pocket size: inside 1 1/2" x 5 3/8"
- Capacity: 1000 lbs.
- Shipped knocked down

Model No. DA932  
Mfg No. 240148  
Price/Each \$1039.00



WESCO

## MORSPEED 1500™ FORKLIFT DRUM HANDLER

- Grab, lift, move and place drums without the operator leaving driver's seat
- Completely Mechanical and Automatic drum grab requires no power source
- Attachments are contoured to securely grasp various rimmed drums
- Works on 30 US gal., 55 US gal and 85 US gal. fibre, plastic or steel drums



DC589

MORSE

Model No.	Minimum Weight per Drum Required to Activate Jaws lbs.	No. of Heads per Drum	No. of Drums	Lifting Capacity lbs./kg	Price /Each
DC589	75	1	1	1500/680	2655.00
DC590	75	1	2	3000/1360	4335.00
DC591	350	2	1	1500/680	3985.00
DC592	350	2	2	3000/1360	6955.00

## FORK MOUNT HOOK

- A fork mounted hook from which to suspend a drum lifter or other device
- Fork Pocket Dimensions: 5-1/2" x 1-9/16"
- Capacity: 2000 lbs.

Model No. LU639  
Price/Each \$289.00

MORSE



## ALL-WELDED DRUM ROCKERS

- Safe method of upending up to 45 imp. gal./55 US gal. drums for moving, draining or storing
- No lifting, straining, or danger of drum tipping backwards
- Load drum into the draining position in seconds
- Constructed of all welded heavy gauge steel tubing
- Removable handle
- 3" polyolefin swivel casters and wheels
- Capacity: 1000 lbs.
- Durable Kleton blue enamel finish



KLETON



Model No.	Description	Wt. lbs.	Price /Each
DC442	Two 3" Swivel Casters, Two 3" Wheels	38	165.00

CAUTION: Clamping bracket on handle must be used when maneuvering unit.

## KNOCKED-DOWN DRUM ROCKERS

- Safe method for moving, draining and storing 45 imp. gal./55 US gal. drums
- Two 3" non-sparking wheels and two 3" non-sparking swivel casters
- Removable handle
- Capacity: 700 lbs.
- Powder coat finish
- Shipped knocked down

KLETON



Model No.	Price /Each
DC443	159.00

CAUTION: Clamping bracket on handle must be used when maneuvering unit.

# DRUM EQUIPMENT

## CLAMP & GO DOLLY HANDLES

- Safely and easily maneuver drum within confined areas
- Perfect for high volume applications
- Low center of gravity provides superior stability
- Quickly clamps onto dollies with various sidewalls of 2", 2 1/2" or 3"
- Foot operated disengage
- Magnet holds handle up to drum for compact storage

Model No. DC414  
Mfg No. 24  
Price/Each \$365.00



## STAINLESS STEEL DRUM DOLLIES

- Handles 45 imp. gal./55 US gal. drums
- 3" hard rubber casters
- Capacity: 800 lbs.
- Weight: 22 lbs.

Model No. DC416  
Price/Each \$455.00



## DRIP CATCHER DOLLIES

- Handles drums that are 22" to 28" in diameter
- 2" lip contains drips
- Absorbent sock included
- 3 3/4" x 1/4" rubber casters
- Overall Dimensions: 31 1/2" dia. x 5 3/4" H
- 1000-lb. capacity
- Weight: 26 lbs.

Model No. DA600  
Price/Each \$522.00



## STEEL DRUM DOLLIES

- Welded 3/16" thick x 4", frames are built to withstand constant use
- 24" inside diameter handles 45 imp. gal./55 US gal. drums
- Comes with four swivel casters
- Quality powder-coat finish
- Shipped knocked down



KLETON



Model No.	Caster Type	Caster Size"	Height"	Capacity lbs.	Wt. lbs.	Price/Each
<b>ROUND FRAME</b>						
DC202	Polyolefin	3	4 1/2	750	21	97.50
DC199	Polyurethane	3	4 1/2	1000	24	109.00
DC200	Polyurethane	4	5 1/2	1500	27	125.00
<b>X-FRAME</b>						
DC206	Polyolefin	3	4 1/2	750	13	74.95
DC203	Polyurethane	3	4 1/2	1000	16	89.95
DC204	Polyurethane	4	5 1/2	1500	19	97.50

## TILTING DRUM DOLLIES

- Designed exclusively for 45 imp. gal./55 US gallon drums
- Unique feature to tilt drums 10° for better liquid extraction
- Tilting feature is foot-operated and locks into place when activated
- Includes four swivel casters



Model No.	Wheel Type	Capacity lbs.	Weight lbs.	Price/Each
DC022	Cast Iron	1200	24	269.00
DC023	Hard Rubber	900	23	279.00

## MULTI-TIER DRUM DOLLIES

- Accommodates a variety of container sizes
- Transport a 5 US gallon pail, 30 US or 45 imp. gal./55 US gal. drums
- A standard 4' long nylon pull strap helps in transporting
- Hard rubber casters
- High polished zinc finish for corrosion resistance
- Capacity: 900 lbs.



DC043

Model No.	No. of Tiers	Accommodates drum sizes (gal.)	Wt. lbs.	Price/Each
DC043	3	5, 30 and LP Gas Cylinders	28	205.00
DC042	4	5, 30, 55 and LP Gas Cylinders	20	235.00
DC415*	4	5, 30, 55, and LP Gas Cylinders	24	575.00

\* Stainless Steel

## HEAVY DUTY DRUM DOLLY

- Transports 55 US (45 imperial) gallon drums
- Includes (4) 4" x 2" side-locking swivel casters
- Frame Material: Steel
- Capacity: 2000 lbs.
- Diameter: 24-1/8"
- Height: 7-1/8"
- Wheel Material: Phenolic

Model No. DC674  
Price/Each \$359.00



## LEAK CONTAINMENT DRUM DOLLIES

- Polyethylene dolly will not dent, corrode, or rust
- Handles 45 imp. gal./55 US gal. drums
- Solid bottom construction with a 2" lip contains spills up to 5 L
- Overall Diameter: 24 1/4"
- Capacity: 1000 lbs.
- Colour: Grey



Model No.	Caster Type	Caster Size"	Height"	Price/Each
DC465	Polyurethane	3	7-5/8	139.00
DC466	Polyolefin	3	7-5/8	139.00
DC467	Polyolefin	4	8-5/8	139.00

# DRUM EQUIPMENT

## DRUM HAND TRUCKS

- All-welded 1 1/4" round tubular steel frame
- Handles containers from as small as 18" in diameter to large 45 imp. gal./55 US gal. steel drums
- Ideal for loading drums onto pallets, or for going over curbs or uneven docks
- Free standing when loaded
- Capacity: 1000 lbs.
- Durable Kleton blue enamel finish



**KLETON**

Model No.	Overall Dimensions W" x D" x H"	Description	Wt. lbs.	Price /Each
DA593	24 x 19 x 58	Truck with 10" front rubber wheels only	48	379.00
DA594	24 x 22 x 58	Truck with 10" front and 6" rear rubber wheels	50	439.00

## DRUM HAND TRUCKS FOR PLASTIC & FIBRE DRUMS

- All-welded, 1 1/4" tubular steel construction
- Handles plastic and fibre drums from 18" to 25" in diameter and 24" to 41" in height
- Rolls on 10" front and 6" rear rubber-tired wheels
- 2" ratchet strap secures drum in place
- Capacity: 1000 lbs.
- Durable Kleton blue enamel finish



**KLETON**

Model No.	Overall Dimensions W" x D" x H"	Description	Wt. lbs.	Price /Each
DA595	23 x 24 x 58	Truck for plastic and fibre drums	55	535.00

## ALL-IN-ONE DRUM TRUCKS

- All-welded design with 1 1/4" round tube
- Drum trucks can be used to transport and dispense drums
- Easy-to-use belt-system and hook keeps drums securely on the truck.
- Easy to load and unload on skids
- Handles plastic, steel or fibre drums
- Loop handle models provide added leverage while dual handle models provide side body comfort.
- Four-wheel design for added support and easy manoeuvrability
- Capacity: 1200 lbs.
- Durable Kleton blue enamel finish



Retaining hook



**KLETON**

Model No.	Handle Type	Wheel Type	Wt. lbs.	Price /Each
DC266	Loop	10" Mold-on Rubber	68	659.00
DC267	Loop	10" Pneumatic	50	715.00
DC256	Dual	10" Mold-on Rubber	54	625.00
DC257	Dual	10" Pneumatic	59	679.00

## LOW PROFILE DRUM TRUCKS

- All-welded steel construction with 8" x 2" rubber wheels and a 4" non-marking rubber swivel caster for smooth movement and easy manoeuvrability
- Ideal for moving full, open top 45 imp. gal./55 US gal. drums without spilling contents
- With a low-level frame, only 1/2" from the ground, this truck allows for easy loading of drums
- Hinged handle moves forward and backward for easy pushing or pulling
- Capacity: 1000 lbs.
- Quality powder coat finish
- Shipped knocked down



**KLETON**



Model No.	Overall Dimensions W" x D" x H"	Overall Handle Length"	Wt. lbs.	Price /Each
DC500	30 x 24 x 46	39	44	209.00

## ERGONOMIC DRUM TRUCK WITH SWIVEL CASTERS

- Rear swivel casters permit greater lateral manoeuvrability, allowing truck to pivot about its axis
- Especially useful in a restricted space, ie. When unloading drums from a truck or in a crowded warehouse
- Provides four-wheel support while transporting drum and steering truck
- 10" Mold-On rubber wheels and 6" Mold-On rubber swivel casters
- Drum Capacity: 55 - 85 US Gal. (45 - 70 Imperial Gal.)
- Capacity: 1000 lbs.

Model No. DA864  
Mfg No. 240121  
Price/Each \$1139.00



**WESCO**

## DRUM HAND TRUCK

- Utility of a hand truck & drum truck
- Chime hook works with 55 and 30 US gallon drums
- Curved frame holds 5-gallon pails and kegs
- Drum Capacity: 5 - 55 US gal. (4.16 - 45 Imperial Gal.)
- Nose Plate Dimensions: 14" W x 8" D
- Overall Dimensions: 21" W x 48" H
- Wheel Material: Mold-on Rubber
- Capacity: 800 lbs.

Model No. DC596  
Mfg No. 210349  
Price/Each \$649.00

**WESCO**





## ERGONOMIC DRUM TRUCKS

- Floating axle reduces effort required to break over and balance load
- Chime hook can be stored at the top of the frame for easy use
- Replaceable hard faced double beveled nose prongs
- Handles steel drums only
- 10" mold-on rubber wheels
- Overall dimensions: 17 1/2" L x 23 3/4" W x 61" H
- Capacity: 1000 lbs.
- Weight: 74 lbs.

**Model No. DC417**  
**Mfg No. 240003**  
**Price/Each \$969.00**



## OVERPACK DRUM TRUCK

- Heavy duty, double-welded joints, 1" structural pipe frame
- Self standing or with kick stand for upright storage
- Recommended primarily for handling of overpacks
- Wide "feet" eliminate the risk of drums being punctured by nose prongs
- Floating axle reduces effort required to break over and balance load
- Drum Capacity: 30 - 85 US gal. (25 - 70 Imperial gal.)
- Overall Dimensions: 24" W x 24" D x 59-3/4" H
- Load Capacity: 1000 lbs.
- Handles: Poly, Overpack Drums

**Model No. DC624**  
**Mfg No. 240077**  
**Price/Each \$1009.00**



## MULTI PURPOSE STAINLESS STEEL DRUM TRUCKS

- Handles heavy drums, loads and unloads pallets, and functions as a high capacity drum dispenser
- For use with 70 imperial gallon salvage or overpack drums, 25 imperial and 45 imp. gal./55 US gal. steel drums and most 25 imperial and 45 imp. gal./55 US gal. plastic drums
- Extra long U-shaped handle provides added leverage when loading and moving heavy drums
- 63" L x 19 1/2" W frame allows easy access through narrow aisles
- Self-supporting for draining
- Four 8" Mortuf wheels with roller bearings allow truck to travel a straight line and permit easy steering around corners with minimal effort
- All-welded, type 304 stainless construction
- Capacity: 1000 lbs.



Model No	Mfg. No.	Wheel Type	Construction Material	Wt. lbs.	Price /Each
DA581	160-SS	Mortuf	Stainless Steel	73	2435.00

## SINGLE BAR DRUM TRUCKS

- Handles 45 imp. gal./55 US gal. steel drums
- Heavy duty 1" structural pipe frame with double welded joints
- Machined steel load wheels behind nose prongs help ease lifting of drum
- Classic single bar frame design
- Kickstand and vinyl handle grips included
- Available with cast iron centre mold-on rubber wheels with 1" (ID) roller bearings or polyolefin wheels
- 24" wide at handle, 16 1/4" wide at nose
- Capacity: 1000 lbs.



Model No.	Mfg. No.	Wheel Type	Wt. lbs.	Price /Each
DA883	240014	Polyolefin	50	1219.00
DA882	240013	Mold-on Rubber	64	1259.00



## ALUMINUM FRAME DRUM TRUCKS W/HAND BRAKE

- Static free for use around volatile materials
- Ideal when the truck itself must be lifted or transported
- Rear wheels act as a pivot to raise truck onto curbs or pallets
- Automatic, spring-loaded chime hook engages rim of 25 imperial or 45 imp. gal./55 US gal. steel drums quickly and safely
- 10" x 2 1/2" solid rubber tires
- Hand brake on DA586 is designed to slow down or stop both load carrying wheels whenever necessary
- Gives operator complete control of truck, even on ramps or inclines
- Capacity: 1000 lbs.

DA586



Model No.	Mfg. No.	Description	Wt. lbs.	Price /Each
DA582	240132	Without Brake	48	3119.00
DA586	240124	With Hand Brake	52	4249.00

## TILTING DRUM RING

- Easily transport steel drums with your fork truck
- Manually rotate drum to dispense light materials
- The band secures around the belly of the drum
- Galvanized steel construction for durable strength
- Drum Capacity: 30 US Gal. (24.98 Imperial Gal.)
- Working Load Limit: 1200 lbs./544 kg
- Usable For Opening Width: 5-1/4"
- Usable Fork Opening Height: 2-7/8"
- Fork Pocket Centre: 28-9/16"
- Rotation: 180°



Model No.	Mfg. No.	Frame Material	Price /Each
DC833	TDR-30-G	Galvanized Steel	195.00
DC834*	TDR-30-SS	Stainless Steel	455.00

\*Stainless Steel Grade 304

## CHEMICAL CHART



CHEMICAL	POLYPROPYLENE	NYLON	ALUMINUM	CAST IRON	304 STAINLESS STEEL	316 STAINLESS STEEL	BRASS
Acetic Acid	Good	Severe Effect	Good	Severe Effect	Severe Effect	Good	Severe Effect
Acetic Acid 20%	Excellent	Severe Effect	Good	Severe Effect	Good	Excellent	Severe Effect
Acetic Acid 80%	Excellent	Severe Effect	Good	Severe Effect	Severe Effect	Good	Severe Effect
Acetone	Excellent	Excellent	Excellent	Excellent	Excellent	Excellent	Excellent
Alcohols: Isopropyl	Excellent	Severe Effect	Good	Excellent	Good	Good	N/A
Ammonia, liquid	Excellent	Good	Excellent	Excellent	Good	Excellent	N/A
Antifreeze	Severe Effect	Severe Effect	Excellent	Excellent	N/A	Excellent	N/A
Benzene	Severe Effect	Excellent	Good	Excellent	Good	Good	N/A
Boric Acid	Excellent	Good	Severe Effect	Severe Effect	Good	Excellent	N/A
Bromine	Severe Effect	Severe Effect	Severe Effect	N/A	Severe Effect	Severe Effect	N/A
Butanol (Butyl Alcohol)	Excellent	Good	Good	N/A	Excellent	Excellent	N/A
Chloric Acid	N/A	Severe Effect	Severe Effect	Severe Effect	Severe Effect	Fair	Severe Effect
Chlorine Water	Severe Effect	Fair	Severe Effect	N/A	Fair	Fair	Severe Effect
Chromic Acid 10%	Severe Effect	Severe Effect	Severe Effect	Severe Effect	Good	Good	Severe Effect
Chromic Acid 30%	Severe Effect	Severe Effect	Severe Effect	Severe Effect	Good	Good	Severe Effect
Chromic Acid 5%	Severe Effect	Severe Effect	Fair	Severe Effect	Good	Excellent	Severe Effect
Chromic Acid 50%	Severe Effect	Severe Effect	Severe Effect	Severe Effect	Fair	Good	Severe Effect
Clorox (Bleach)	Severe Effect	Excellent	Excellent	Severe Effect	Excellent	Excellent	N/A
Diesel Fuel	Excellent	Excellent	Excellent	Excellent	Excellent	Excellent	Excellent
Ethanol	Excellent	Good	Good	Good	Excellent	Excellent	Excellent
Ethylene Glycol	Good	Excellent	Excellent	Excellent	Good	Good	Good
Fuel Oils	Excellent	Excellent	Fair	Excellent	Excellent	Excellent	Good
Gasoline, unleaded	Fair	Excellent	Excellent	Excellent	Excellent	Excellent	N/A
Glycerin	Excellent	Excellent	Excellent	Excellent	Excellent	Excellent	Good
Heptane	Fair	Excellent	Excellent	Excellent	Excellent	Excellent	Excellent
Hexane	Good	Good	Excellent	Excellent	Excellent	Excellent	Excellent
Hydrochloric Acid 100%	Good	Severe Effect	Severe Effect	Severe Effect	Severe Effect	Severe Effect	Severe Effect
Hydrochloric Acid 20%	Good	Severe Effect	Severe Effect	Severe Effect	Severe Effect	Severe Effect	N/A
Hydrochloric Acid 37%	Fair	Severe Effect	Severe Effect	Severe Effect	Severe Effect	Severe Effect	N/A
Hydrofluoric Acid 100%	Fair	Severe Effect	Severe Effect	Severe Effect	Good	Good	N/A
Hydrofluoric Acid 20%	Excellent	Fair	Severe Effect	Severe Effect	Severe Effect	Severe Effect	N/A
Hydrofluoric Acid 50%	Excellent	Severe Effect	Severe Effect	Severe Effect	Severe Effect	Severe Effect	N/A
Hydrofluoric Acid 75%	Fair	Severe Effect	Severe Effect	Severe Effect	Severe Effect	Severe Effect	N/A
Hydrogen Peroxide 10%	Excellent	Fair	Excellent	Fair	Good	Good	N/A
Hydrogen Peroxide 100%	Good	Severe Effect	Excellent	Good	Good	Excellent	Severe Effect
Hydrogen Peroxide 30%	Good	Severe Effect	Excellent	Good	Good	Good	N/A
Hydrogen Peroxide 50%	Good	Severe Effect	Excellent	N/A	Good	Excellent	N/A
Ink	N/A	Fair	N/A	Severe Effect	Fair	Fair	N/A
Iodine	Fair	Excellent	Excellent	Severe Effect	Severe Effect	Severe Effect	N/A
Jet Fuel (JP3, JP4, JPS)	Excellent	Fair	Excellent	Excellent	Excellent	Excellent	N/A
Kerosene	Good	Excellent	Excellent	Excellent	Excellent	Excellent	Excellent
Ketones	Fair	Excellent	Good	N/A	Excellent	Excellent	N/A
Lacquer Thinners	Severe Effect	Excellent	Excellent	Fair	Excellent	Excellent	Excellent
Lacquers	Severe Effect	Excellent	Excellent	Fair	Excellent	Excellent	N/A
Methanol (Methyl Alcohol)	Excellent	Good	Excellent	Excellent	Excellent	Excellent	Excellent
Methyl Ethyl Ketone	Good	Excellent	Good	Excellent	Excellent	Excellent	Excellent
Mineral Spirits	Good	Excellent	Excellent	Good	Excellent	Excellent	N/A
Motor oil	Excellent	Excellent	Excellent	N/A	Excellent	Excellent	N/A
Naphtha	Good	Excellent	Excellent	Good	Excellent	Excellent	Excellent
Nitric Acid (20%)	Excellent	Severe Effect	Severe Effect	Severe Effect	Excellent	Excellent	Severe Effect
Nitric Acid (50%)	Good	Severe Effect	Severe Effect	Severe Effect	Excellent	Excellent	Severe Effect
Nitric Acid (5-10%)	Excellent	Severe Effect	Excellent	Severe Effect	Excellent	Excellent	Severe Effect
Nitric Acid (Concentrated)	Severe Effect	Severe Effect	Severe Effect	Severe Effect	Excellent	Excellent	Severe Effect
Oils: Diesel Fuel (20, 30, 40, 50)	Excellent	Excellent	Excellent	Excellent	Excellent	Excellent	N/A
Oils: Fuel (1, 2, 3, 5A, 5B, 6)	Good	Excellent	Fair	Excellent	Excellent	Excellent	Good
Oils: Hydraulic Oil (Petro)	Severe Effect	Excellent	Excellent	Excellent	Excellent	Excellent	Excellent
Oils: Hydraulic Oil (Synthetic)	Severe Effect	Excellent	Excellent	N/A	Excellent	Excellent	Excellent
Oils: Linseed	Excellent	Excellent	Good	N/A	Excellent	Excellent	Good
Oils: Mineral	Excellent	Excellent	Excellent	N/A	Excellent	Excellent	Excellent
Phosphoric Acid (>40%)	Excellent	Good	Fair	Severe Effect	Severe Effect	Severe Effect	Severe Effect
Phosphoric Acid (crude)	Good	Good	Fair	Severe Effect	Severe Effect	Good	N/A
Phosphoric Acid (molten)	Severe Effect	N/A	Fair	N/A	N/A	Fair	N/A
Phosphoric Acid (540%)	Excellent	Good	Fair	Severe Effect	Severe Effect	Fair	Severe Effect
Potassium Hydroxide Caustic Potash	Excellent	Fair	Severe Effect	Good	Good	Excellent	Severe Effect
Rust Inhibitors	Excellent	N/A	N/A	Fair	Excellent	Excellent	N/A
Sea Water	Excellent	Excellent	Good	Severe Effect	Fair	Fair	Severe Effect
Soap Solutions	Excellent	Excellent	Fair	Excellent	Excellent	Excellent	Good
Sodium Hydroxide (20%)	Excellent	Excellent	Severe Effect	Excellent	Good	Good	Good
Sodium Hydroxide (50%)	Excellent	Excellent	Severe Effect	Severe Effect	Good	Good	Severe Effect
Sodium Hydroxide (80%)	Excellent	Fair	Severe Effect	Severe Effect	Fair	Good	Severe Effect
Sodium Hypochlorite (<20%)	Excellent	Severe Effect	Severe Effect	Severe Effect	Fair	Fair	Severe Effect
Sodium Hypochlorite (100%)	Good	Severe Effect	Severe Effect	Severe Effect	Severe Effect	Severe Effect	Severe Effect
Stoddard Solvent	Fair	Excellent	Excellent	Excellent	Excellent	Excellent	N/A
Sulfuric Acid (<10%)	Excellent	Fair	Severe Effect	Fair	Severe Effect	Good	N/A
Sulfuric Acid (10-75%)	Excellent	Severe Effect	Severe Effect	Severe Effect	Severe Effect	Severe Effect	N/A
Sulfuric Acid (75-100%)	Fair	Severe Effect	Severe Effect	Severe Effect	Fair	Severe Effect	N/A
Sulfuric Acid (cold concentrated)	Excellent	Severe Effect	Good	Severe Effect	Fair	Good	N/A
Sulfuric Acid (hot concentrated)	Severe Effect	Severe Effect	Severe Effect	Severe Effect	Severe Effect	Fair	N/A
Toluene (Toluol)	Fair	Excellent	Excellent	Excellent	Excellent	Excellent	Excellent
Trichloroethane	Fair	Fair	Severe Effect	Good	Good	Good	N/A
Trisodium Phosphate	Excellent	Excellent	Severe Effect	N/A	Good	Good	N/A
Turpentine	Severe Effect	Good	Excellent	N/A	Excellent	Excellent	Severe Effect
Vinegar	Excellent	Excellent	Severe Effect	Severe Effect	Excellent	Excellent	Severe Effect
Water, Deionized	Excellent	Excellent	Excellent	Severe Effect	Excellent	Excellent	Excellent
Water, Distilled	Excellent	Excellent	Excellent	Severe Effect	Excellent	Excellent	Excellent
Water, Fresh	Excellent	Excellent	Good	Severe Effect	Excellent	Excellent	Good
Water, Salt	Excellent	Excellent	Good	Severe Effect	Good	Good	Severe Effect
Xylene	Good	Excellent	Excellent	Good	Good	Good	Excellent

## CHEMICAL CHART

CHEMICAL	RYTON (PPS)	VITON	TEFLON	BUNA N	EDPM	HYPALON	PVC
Acetic Acid	Excellent	Good	Excellent	Fair	Excellent	Fair	Severe Effect
Acetic Acid 20%	Excellent	Good	Excellent	Good	Excellent	Excellent	Severe Effect
Acetic Acid 80%	Excellent	Good	Excellent	Fair	Excellent	Fair	Fair
Acetone	Excellent	Severe Effect	Excellent	Severe Effect	Excellent	Fair	Severe Effect
Alcohols: Isopropyl	N/A	Excellent	Excellent	Good	Excellent	Excellent	Excellent
Ammonia, liquid	Excellent	Severe Effect	Excellent	Fair	Excellent	Severe Effect	Excellent
Antifreeze	N/A	Excellent	N/A	Excellent	Excellent	N/A	Excellent
Benzene	Excellent	Excellent	Excellent	Severe Effect	Severe Effect	Severe Effect	Fair
Boric Acid	Excellent	Excellent	Excellent	Excellent	Excellent	Excellent	Excellent
Bromine	Severe Effect	Excellent	Excellent	Severe Effect	Severe Effect	Severe Effect	Fair
Butanol (Butyl Alcohol)	Excellent	Excellent	Excellent	Excellent	Excellent	Excellent	Fair
Chloric Acid	N/A	N/A	Excellent	N/A	N/A	N/A	Excellent
Chlorine Water	Severe Effect	Excellent	Excellent	Severe Effect	Fair	Fair	Excellent
Chromic Acid 10%	Excellent	Good	Excellent	Severe Effect	Fair	Fair	Excellent
Chromic Acid 30%	Good	Excellent	Excellent	Severe Effect	Good	Fair	Excellent
Chromic Acid 5%	Excellent	Excellent	Excellent	Severe Effect	Excellent	Good	Excellent
Chromic Acid 50%	Excellent	Excellent	Excellent	Severe Effect	Good	Fair	Severe Effect
Cloroxr (Bleach)	Severe Effect	Excellent	Excellent	Severe Effect	Good	Good	Excellent
Diesel Fuel	Excellent	Excellent	Excellent	Excellent	Severe Effect	Good	Excellent
Ethanol	N/A	Excellent	Excellent	Fair	Excellent	Excellent	Fair
Ethylene Glycol	Excellent	Excellent	Excellent	Excellent	Excellent	Excellent	Excellent
Fuel Oils	Excellent	Excellent	Good	Excellent	Severe Effect	Fair	Excellent
Gasoline, unleaded	Excellent	Excellent	Excellent	Excellent	Severe Effect	Excellent	Fair
Glycerin	Excellent	Excellent	Excellent	Excellent	Excellent	Excellent	Excellent
Heptane	Excellent	Excellent	Excellent	Excellent	Severe Effect	Good	Fair
Hexane	Excellent	Excellent	Excellent	Excellent	Severe Effect	Good	Good
Hydrochloric Acid 100%	Severe Effect	Excellent	Excellent	Severe Effect	Severe Effect	Severe Effect	Severe Effect
Hydrochloric Acid 20%	Severe Effect	Excellent	Excellent	N/A	Excellent	Excellent	Excellent
Hydrochloric Acid 37%	Severe Effect	Excellent	Excellent	Good	Fair	Good	Good
Hydrofluoric Acid 100%	Severe Effect	Good	Excellent	Severe Effect	Severe Effect	Good	Fair
Hydrofluoric Acid 20%	Excellent	Excellent	Excellent	Severe Effect	Severe Effect	Good	Good
Hydrofluoric Acid 50%	Excellent	Good	Excellent	Severe Effect	Severe Effect	Good	Good
Hydrofluoric Acid 75%	Good	Good	Excellent	Severe Effect	Fair	Good	Fair
Hydrogen Peroxide 10%	Excellent	Excellent	Excellent	Severe Effect	Excellent	Severe Effect	Excellent
Hydrogen Peroxide 100%	Fair	Excellent	Excellent	Severe Effect	Severe Effect	Severe Effect	Excellent
Hydrogen Peroxide 30%	Excellent	Excellent	Excellent	Severe Effect	Good	Severe Effect	Excellent
Hydrogen Peroxide 50%	N/A	Excellent	Excellent	Severe Effect	Good	Severe Effect	Excellent
Ink	N/A	Excellent	Excellent	Excellent	N/A	N/A	Fair
Iodine	Severe Effect	Excellent	Excellent	Good	Good	Severe Effect	Excellent
Jet Fuel (JP3, JP4, JP5)	Excellent	Excellent	Excellent	Excellent	Severe Effect	Severe Effect	Fair
Kerosene	Excellent	Excellent	Excellent	Excellent	Severe Effect	Severe Effect	Excellent
Ketones	Excellent	Severe Effect	Excellent	Severe Effect	Excellent	N/A	Severe Effect
Lacquer Thinners	N/A	Severe Effect	Excellent	Severe Effect	Severe Effect	Severe Effect	Severe Effect
Lacquers	N/A	Severe Effect	Excellent	Severe Effect	Severe Effect	Severe Effect	Severe Effect
Methanol (Methyl Alcohol)	Excellent	Fair	Excellent	Excellent	Excellent	Excellent	Excellent
Methyl Ethyl Ketone	Excellent	Severe Effect	Excellent	Severe Effect	Excellent	Severe Effect	Severe Effect
Mineral Spirits	Excellent	Excellent	Excellent	Excellent	Severe Effect	Fair	Excellent
Motor oil	Excellent	N/A	Excellent	Excellent	Severe Effect	N/A	Good
Naphtha	Excellent	Excellent	Good	Excellent	Severe Effect	Severe Effect	Excellent
Nitric Acid (20%)	Fair	Excellent	Excellent	Severe Effect	Excellent	Severe Effect	Excellent
Nitric Acid (50%)	Fair	Excellent	Excellent	Severe Effect	Severe Effect	Severe Effect	Good
Nitric Acid (5-10%)	Good	Excellent	Excellent	Severe Effect	Excellent	Good	Excellent
Nitric Acid (Concentrated)	Fair	Excellent	Excellent	Severe Effect	Severe Effect	Severe Effect	Good
Oils: Diesel Fuel (20, 30, 40, 50)	Excellent	Excellent	Excellent	Excellent	Severe Effect	Good	Good
Oils: Fuel (1, 2, 3, 5A, 5B, 6)	Excellent	Good	Excellent	Good	Severe Effect	Severe Effect	Excellent
Oils: Hydraulic Oil (Petro)	Severe Effect	Excellent	Excellent	Excellent	Severe Effect	Excellent	Excellent
Oils: Hydraulic Oil (Synthetic)	N/A	Excellent	Excellent	Severe Effect	Excellent	Excellent	Excellent
Oils: Linseed	Good	Excellent	Excellent	Excellent	Severe Effect	Fair	Excellent
Oils: Mineral	Excellent	Excellent	Excellent	Excellent	Severe Effect	Good	Good
Phosphoric Acid (>40%)	Excellent	Excellent	Excellent	Severe Effect	Good	Good	Good
Phosphoric Acid (crude)	Excellent	Excellent	Excellent	Severe Effect	Good	Good	Good
Phosphoric Acid (molten)	N/A	N/A	N/A	N/A	N/A	N/A	Severe Effect
Phosphoric Acid (540%)	Excellent	Excellent	Excellent	Severe Effect	Good	Good	Good
Potassium Hydroxide (Caustic Potash)	Excellent	Good	Excellent	Good	Excellent	Excellent	Excellent
Rust Inhibitors	N/A	Excellent	N/A	Excellent	N/A	N/A	N/A
Sea Water	Excellent	Excellent	Excellent	Excellent	Excellent	Excellent	Excellent
Soap Solutions	Excellent	Excellent	Excellent	Excellent	Excellent	Excellent	Excellent
Sodium Hydroxide (20%)	Excellent	Fair	Excellent	Excellent	Good	Excellent	Excellent
Sodium Hydroxide (50%)	Excellent	Severe Effect	Excellent	Excellent	Good	Excellent	Excellent
Sodium Hydroxide (80%)	Excellent	Severe Effect	Excellent	Severe Effect	Good	Excellent	Excellent
Sodium Hypochlorite (<20%)	Excellent	Excellent	Excellent	Good	Good	Excellent	Excellent
Sodium Hypochlorite (100%)	Excellent	Excellent	Excellent	Severe Effect	Good	Good	Good
Stoddard Solvent	Excellent	Excellent	Excellent	Excellent	Severe Effect	N/A	Fair
Sulfuric Acid (<10%)	Excellent	Excellent	Excellent	Excellent	Excellent	Excellent	Excellent
Sulfuric Acid (10-75%)	Excellent	Excellent	Excellent	Good	Good	Good	Excellent
Sulfuric Acid (75-100%)	Excellent	Excellent	Excellent	Fair	Good	Fair	Severe Effect
Sulfuric Acid (cold concentrated)	Excellent	Good	Excellent	Severe Effect	Fair	Fair	Severe Effect
Sulfuric Acid (hot concentrated)	Severe Effect	Excellent	Excellent	Severe Effect	Severe Effect	Severe Effect	Severe Effect
Toluene (Toluol)	Excellent	Fair	Excellent	Severe Effect	Severe Effect	Severe Effect	Severe Effect
Trichloroethane	N/A	Excellent	Excellent	Severe Effect	Severe Effect	Severe Effect	Fair
Trisodium Phosphate	Excellent	Excellent	Excellent	Excellent	Excellent	N/A	Excellent
Turpentine	Excellent	Excellent	Excellent	N/A	Severe Effect	Severe Effect	Severe Effect
Vinegar	Excellent	Excellent	Excellent	Good	Excellent	Excellent	Good
Water, Deionized	Excellent	Excellent	Excellent	Excellent	Excellent	Excellent	Excellent
Water, Distilled	Excellent	Excellent	Excellent	Excellent	Excellent	N/A	Excellent
Water, Fresh	Excellent	Excellent	Excellent	Excellent	Excellent	N/A	Good
Water, Salt	Excellent	Excellent	Excellent	Excellent	Excellent	N/A	Good
Xylene	Excellent	Good	Excellent	Severe Effect	Severe Effect	Severe Effect	Severe Effect





## PULL TYPE DRUM PUMPS

### Chemical compatibility of a drum or barrel pump should be checked for EACH LIQUID BY CHEMICAL NAME!

No single drum pump can be universally chemical resistant. Some blends of chemicals may not be suitable for any of these drum pumps. Remember to have your MSDS for each chemical that will be pumping when calling your our representative. We will be able to help you select the right pump for your application.

### POLYPROPYLENE



#### Wetted components:

Polyethylene, polypropylene, silicone and steel

- For use with most corrosive chemicals and non-flammable solvents
- Adapts to 3/4" or 2" bung adaptor for 5 to 55-gallon drums
- 360° discharge spout orientation
- Transfer Rate: 16 oz. per stroke

**Model No. DC115**  
**Price/Each \$29.05**



#### Wetted components:

Polypropylene, steel and Viton®

- For use with most antifreeze, detergents, windshield fluids, glycerin, and mild acids
- Fits 15 to 55-gallon drums with 2" bung adaptor
- Transfer Rate: 14 oz. per stroke

**Model No. DC127**  
**Price/Each \$58.50**



#### Wetted components:

Polyethylene, polypropylene and nylon

- For use with most corrosive chemicals, water, and non-flammable solvents
- Good insulation from spark and fire
- Fits 55-gallon drums with a 2" bung adaptor
- Transfer Rate: 22 oz. per stroke

**Model No. DC117**  
**Price/Each \$39.60**



#### Wetted components:

Polypropylene, polyethylene, silicone and steel

- For use with most corrosive chemicals and non-flammable solvents
- Adapts to 3/4" or 2" bung adaptor for 5 to 55-gallon drums
- 360° discharge spout orientation
- Transfer Rate: 8 oz. per stroke

**Model No. DA532**  
**Price/Each \$29.70**



### PVC



#### Wetted components:

Polypropylene, PVC, nylon and Viton®

- For use with most mild acids, detergents, water and solvents
- Good insulation from spark and fire
- Transfer rate: 8 oz. per stroke

**Model No. DC116**  
**Price/Each \$45.70**



#### Wetted components:

PVC, nylon and Viton®

- For use with most mild acids, detergents, water and solvents
- Good insulation from spark and fire
- Fits 55-gallon drums with a 2" bung adaptor
- Transfer Rate: 22 oz. per stroke

**Model No. DC118**  
**Price/Each \$61.20**



### NYLON

#### Wetted components:

Polypropylene, nylon, 304 stainless steel and PTFE

- For use with most lacquer thinners, mild acids, detergents, water and light viscosity petroleum liquids
- Fits 15 to 55-gallon drums with 2" bung adaptor
- Transfer Rate: 14 oz. per stroke

**Model No. DC128**  
**Price/Each \$88.20**



### FM APPROVED PULL TYPE DRUM PUMP

- For fast transfer of most solvents, acids and corrosives chemicals
- Fits 15-55-gallon drums with a 2" bung adaptor
- Pump body made from 316 Stainless Steel with PTFE Piston & PTFE Sealing Gasket
- Heavy-Duty bonding and grounding wires prevent hazardous static charge
- Wires are secured by locknut and have heavy-duty alligator clips
- Built-in internal flame arrestor prevents flame flashback
- Wetted components: 316 Stainless Steel, PTFE
- Transfer Rate: 7 oz./Stroke
- Fits Gallon Size: 15 - 55 gal.
- Body Material: Stainless Steel
- Adaptor Type: 2" Bung

**Model No. DC765**  
**Price/Each \$399.00**



## ROTARY LOBE PUMPS OVERVIEW

Lobe pumps are popular in diverse industries because they offer superb sanitary qualities, high efficiency, reliability, corrosion resistance and good clean-in-place and sterilize-in-place characteristics.

Rotary lobe pumps are non-contacting and have large pumping chambers. If wetted, they offer self-priming performance. A gentle pumping action minimizes product degradation. They also offer reversible flows and can operate dry for long periods of time.

### Advantages:

- Pass medium solids
- No metal-to-metal contact
- Superior CIP/SIP capabilities
- Long term dry run (with lubrication to seals)
- Non-pulsating discharge

### Wetted components:

Aluminum, Buna-N, cast iron, chrome plated, polypropylene, steel and zinc.

- For use with most low viscosity and non-corrosive petroleum based fluids
- Dual directional operation for rapid discharge
- Fits 55-gallon drums with a 2" bung adaptor
- Transfer Rate: 1 L per revolution

**Model No. DC111**

**Price/Each \$369.00**

**KLETON**



## LEVER TYPE DRUM PUMPS

### POLYPROPYLENE

#### Wetted components:

304 stainless steel, chrome plated, polyethylene, polypropylene and Viton®

- Use with certain water-based solvents, mild acids and light viscosity petroleum liquids
- Adapts to 1-1/2" or 2" bung adaptor for 5 to 55-gallon drums
- Transfer Rate: 14 oz. per stroke

**Model No. DC121**

**Price/Each \$72.75**

**KLETON**



### POLYPHENYLENE SULFIDE

#### Wetted components:

316 stainless steel, polypropylene, polyphenylene sulfide and PTFE

- Use with most water-based solvents, strong acids or alkalis and light viscosity petroleum liquids
- Adapts to 1-1/2" or 2" bung adaptor for 5 to 55-gallon drums
- Transfer Rate: 14 oz. per stroke

**Model No. DC122**

**Price/Each \$128.00**

**KLETON**



### PTFE

#### Wetted components:

316 stainless steel and PTFE

- Use with certain water-based solvents, strongest acids or alkaline solutions
- Adapts to 1-1/2" or 2" bung adaptor for 5 to 55-gallon drums
- Transfer Rate: 14 oz. per stroke

**Model No. DC123**

**Price/Each \$349.00**

**KLETON**



### STEEL

#### Wetted components:

Brass, Buna-N, polyethylene, steel and zinc

- Use with most dispensing and transferring non-corrosive and petroleum based fluids
- Cushioned vinyl grip handle
- Discharge spout can be rotated 180° and removed to expose garden hose threaded outlet
- Adapts to 1-1/2" or 2" bung adaptor for 30 to 55-gallon drums
- Transfer Rate: 11 oz. per stroke

**Model No. DC124**

**Price/Each \$62.95**

**KLETON**



## POLYETHYLENE SIPHON PUMPS

### Wetted components:

Polyethylene

- Use with most water based liquids, light oils, and detergents
- Air vent in handle controls flow
- Fits 5-gallon pails
- Transfer Rate: 2 gallons/minute

**Model No. DC120**

**Price/Each \$5.45**



### Wetted components:

Polyethylene

- Use with most water based liquids, light oils and detergents
- Air vent in handle controls flow
- Fits 15 to 55-gallon drums with 2" bung adaptor
- Transfer Rate: 7 gallons/minute

**Model No. DC119**

**Price/Each \$19.60**



**KLETON**

## PAIL TYPE PUMPS

### Wetted components:

Delrin®, polyethylene, PVC and steel

- Use with most engine oils, gear oils, and antifreeze
- Fits 5 gallon pails
- Includes a 48" discharge hose fitted with curved metal spout at discharge end
- Transfer Rate: 2 oz. per stroke
- Comes with a Rieke® adaptor

**Model No. DC129**

**Price/Each \$46.95**

**KLETON**



# PUMPS

## ROTARY TYPE DRUM PUMPS

### ROTARY VANE PUMPS OVERVIEW

While vane pumps can handle moderate viscosity liquids, they excel at handling low viscosity liquids such as LP gas (propane), ammonia, solvents, alcohol, fuel oils, gasoline and refrigerants. Vane pumps have no internal metal-to-metal contact and self-compensate for wear, enabling them to maintain peak performance on these non-lubricating liquids. Vane pumps are noted for their dry priming, ease of maintenance, and good suction characteristics over the life of the pump.

#### Advantages

- Handles thin liquids at relatively higher pressures
- Compensates for wear through vane extension
- Sometimes preferred for solvents, LPG
- Can run dry for short periods
- Can be equipped with a gasket or a stuffing box
- Develops good vacuum

## ROTARY DRUM PUMP

### Wetted components:

Stainless steel, PVDF and PTFE

- For most aggressive chemicals such as acids and alkalines
- Transfer Rate: 12 oz. per revolution
- Fits Gallon Size: 30 - 55 Gal.
- Adaptor Type: 2" bung adaptor

Model No. DB997

Price/Each \$605.00



## ROTARY TYPE DRUM PUMP

- For most organic acids, alcohols and solvents
- Fits 15 to 55-gallon drums with a 2" bung adaptor
- Transfer Rate: 12 oz./Stroke
- Fits Gallon Size: 55 Gal.
- Body Material: Stainless Steel
- Adaptor Type: 2" Bung

Model No. DC865

Price/Each \$599.00



## ALUMINUM

### Wetted components:

Aluminum, Buna-N, PVC nitrile, steel and zinc

- Use with most low viscosity, non-corrosive petroleum based fluids and lubricating oils up to SAE30
- Fits 15 to 55-gallon drums with a 2" bung adaptor
- Transfer rate: 6-3/4 oz. per revolution
- Includes a safety locking latch
- 3/4" dia. x 1.8 m long PVC nitrile discharge hose included

Model No. DC126

Price/Each \$240.00



### Wetted components:

Aluminum, Ryton, Viton® and Steel

- For Use With: Most Medium Viscosity & Non-Corrosive Petroleum Based Fluids
- Fits 5-, 15-, 30- and 55-gallon drums with a 2" bung adaptor
- Transfer Rate: 9.5 oz./Stroke
- Fits Gallon Size: 5-55 gal.
- Body Material: Aluminum
- Adaptor Type: 2" Bung
- Transfer Rate: 9.5 oz. (280 CC) Per Revolution

Model No. DC806

Price/Each \$139.00



## POLYPROPYLENE

### Wetted components:

304 stainless steel, polypropylene, PVDF, PTFE and Viton®

- For most water-soluble inorganic acids, waxes, detergents
- Fits 15 to 55-gallon drums with a 2" bung adaptor
- Transfer Rate: 8 oz. per revolution

Model No. DB998

Price/Each \$153.00



## ALUMINUM DIAPHRAGM HAND PUMP

### Wetted components:

Aluminum, Buna-N, Poly Acetal, 304 stainless steel and steel

- For use with most motor oil and other light petroleum products
- Fits 15 to 55-gallon drums with 2" bung adaptor
- Transfer Rate: 25.5 oz. per stroke
- Includes a safety locking latch and discharge hose

Model No. DC068

Price/Each \$345.00



## ALUMINUM & CAST IRON

### Wetted components:

Cast iron, steel, graphite, polypropylene, aluminum, EPDM rubber and Buna-N

- FM approved pump with 8' antistatic hose, nozzle, flame arrestor and vacuum breaker
- For use with class 1 and class 2 flammable and combustible liquids such as gasoline, alcohols, and other solvents
- Fits 15 to 55-gallon drums with a 2" bung adaptor
- Transfer Rate: 10 gallons per minute

Model No. DC505

Price/Each \$405.00



## STEEL & CAST IRON

### Wetted components:

Buna-N, cast iron, polyethylene, polypropylene and steel

- For use with most medium viscosity petroleum fluid, light non-flammable and non-combustible fluids
- Dual directional operation allows pump to both empty and refill containers
- Fits 30 to 55-gallon drums with a 2" bung adaptor
- Transfer Rate: 8 oz. per revolution
- Steel discharge spout and 1" dia. x 55" L polyethylene discharge hose included

Model No. DA528

Price/Each \$109.00



DC098  
Polyethylene  
discharge hose



## ENVIRO-WEDGE™

- 100% recycled, rugged polyethylene construction
- The Enviro-Wedge™ increases the amount of product pumped out of 25-45 gallon drums: When the drum is nearly empty tilt it on an angle and position the wedge under the drum; Continue pumping until flow stops.

Model No. DA660

Mfg. No. ENV55

Price/Each \$36.50





## SMALL SUBMERSIBLE OIL FILLED PUMPS

- 1/160 HP oil-filled motor, 115 V, 60 Hz, 0.5 A
- Corrosion resistant nylon body
- 4.6' maximum lift
- 1/4" MNPT discharge
- Intermittent liquid temp up to 120 °F
- 10' power cord length
- For submersible use only
- Max Flow Rate 120 GPH

**Model No. DA342**  
**Price/Each \$229.00**



Little GIANT  
PUMP COMPANY

## 5.5 SERIES SUMP PUMP

- PSC motor with thermal overload protection
- Integral snap-action float switch
- 1-1/2" discharge
- 3/4" GHT (19mm) garden hose adapter included
- Screened inlet handles up to 3/8" (9.5 mm) solids
- 120 °F (49 °C) liquid temperature rating
- cCSAus listed
- Motor: 1/4 HP
- Max. Flow Rate: 35 GPM
- Voltage: 115 V
- Amps: 3.5 A
- Cord Length: 10' (3 m)
- Manufacturer's Warranty: 3 Years

**Model No. UAK135**  
**Price/Each \$275.00**



Little GIANT  
PUMP COMPANY

## 9EC SERIES EFFLUENT PUMP

- Permanent Split Capacitor (PSC)
- Designed for continuous duty
- Energy-saving low amp draw
- 1-1/2" FNPT (38 mm) discharge
- Handles solids up to 3/4" (19 mm) diameter
- Piggyback float switch
- 140 °F (60 °C) liquid temperature rating
- cCSAus listed
- Motor: 4/10 HP
- Max. Flow Rate: 70 GPM
- Voltage: 115 V
- Amps: 7.5 A
- Cord Length: 20' (6.1 m)
- Manufacturer's Warranty: 3 Years

**Model No. UAK146**  
**Price/Each \$715.00**



Little GIANT  
PUMP COMPANY

## HIGH TEMPERATURE SUMP/EFFLUENT PUMPS

- 1/3 HP, 115 V, 60 Hz, 10.1 A
- Handles liquids up to 200 °F and solids up to 1/2"
- Cast iron pump housing with protective epoxy coating for corrosion resistance
- Oil-filled motor housing for lifetime lubrication and rapid heat dissipation
- Integral mechanical float switch
- Stainless steel screws, bolts and lifting ring to protect against corrosion
- Bearings: Upper and lower sintered sleeve bearings for extended motor life
- 15' Power cord
- Thermal overload protection
- Automatic operation has 10" to 12" "On" level range
- Max. Flow Rate: 50 GPH

**Model No. DA336**  
**Price/Each \$1155.00**



Little GIANT  
PUMP COMPANY

## AUTOMATIC SWITCHES

- Converts manual pump up through 1/2 HP to automatic operation
- Turns on at 6 - 9" and off at 1 - 4"
- 18' power cord
- CSA listed

**Model No. DA357**  
**Price/Each \$189.00**

Little GIANT  
PUMP COMPANY



## SUBMERSIBLE PUMPS

- 1/3 HP shaded pole motor, 115 V, 9 A
- 1/2" 1-1/4" FNPT x 1-1/2" MNPT adapter
- Cast iron pump housing with protective epoxy coating for corrosion resistance
- Oil-filled motor housing for lifetime lubrication and rapid heat dissipation
- Stainless steel screws, bolts and handle to protect against corrosion
- Bearings: Upper and lower sintered sleeve bearings for extended motor life
- 8' Power cord
- Thermal overload protection
- Automatic operation with pressure switch activates pump when water level is between 7" and 10"
- Pump shuts off when water level falls to between 1" and 4"
- Max. Flow Rate: 46 GPH

**Model No. DA334**  
**Price/Each \$399.00**



Little GIANT  
PUMP COMPANY

## SUMP/EFFLUENT PUMPS

- 1/3 HP shaded pole motor, 115 V, 5 A
- Handles liquid and solid waste materials up to 1/2" diameter
- Cast iron pump housing with protective epoxy coating for corrosion and rust resistance
- Oil-filled motor housing for lifetime lubrication and rapid heat dissipation
- Stainless steel screws, bolts and handle
- Bearings: Upper and lower sintered sleeve bearings
- 10' Power cord
- Thermal overload protection
- Automatic operation has 8" to 11" "On" level range and 2" to 5" "Off" level range
- Integral snap action float switch
- Base Material: Polypropylene
- Max. Flow Rate: 53 GPH

**Model No. DC431**  
**Price/Each \$369.00**



Little GIANT  
PUMP COMPANY

## ELECTRIC SEWAGE PUMP

- Features a permanent split capacitor, energy-saving low amp draw, and multiple switch options for automatic operation
- Designed for continuous duty
- Handles solids up to 2" diameter
- Motor: 1/2 HP
- Max. Flow Rate: 120 GPM
- Voltage: 115 V
- Amps: 11 A
- Max. Diameter of Waste: 2"
- Liquid Temperature Rating: 140 °F (60 °C)
- Switch Type: Piggyback Mechanical Float
- Max. Flow Rate @ 10 ft: 100 GPM
- Max. Flow Rate @ 15 ft: 80 GPM

**Model No. DC818**  
**Price/Each \$835.00**



# PUMPS

## DUAL PURPOSE PUMPS

- Operates submersed or in-line (water-fed via pipe/hose)
- Cast aluminum housing with protective epoxy coating
- Threaded intake and discharge
- Nylon pumping head and impeller
- Thermal overload protection
- For use with water only
- 10' power cord
- Nylon screen
- UL listed, CSA certified



### Model No. DA328

- 3/8" FNPT intake and 1/4" MNPT discharge
- Buna-N seal
- 1.7 amps
- 100 watts
- 5 1/2" L x 3 1/2" W x 4 3/4" H

### Model No. DA329

- 1/2" FNPT intake and 1/2" MNPT discharge
- Viton® Seal
- 3.2 amps
- 200 watts
- 7" L x 4 1/2" W x 5 1/2" H



## AUTOMATIC CONDENSATE REMOVAL PUMPS - VCMA SERIES

- Vertical type pump unit
- 1/2 gallon leak proof, rustproof, ABS tank with mounting tabs
- Stainless steel motor shaft
- Three drain holes
- 3/8" O.D. barbed discharge adapter and removable 3/8" barbed check valve
- Snap-action safety switch
- Thermal overload protected
- Suitable for high-efficiency, gas furnace condensate
- 15' shut-off head
- 6' power cord
- Weight: 4.40 lbs.
- UL/CSA listed



### Construction

**Motor:** 1/50 HP high performance

**Intermittent liquid temperature:** Up to 120°F

**Discharge:** 3/8" OD barbed

**Housing:** ABS

**Cover:** ABS

**Volute:** ABS

**Impeller:** Glass filled polypropylene

**Model No. DC294**

**Price/Each \$145.00**



Model No.	HP	Volts	Gallons/Hour			Shut Off'	PSI	Wt. lbs.	Price /Each	
			1'	5'	10'					
DA328	1/40	115	300	255	205	70	11.8	5.1	4	319.00
DA329	1/15	115	500	435	337	210	17.3	7.5	8	479.00

## NON-SUBMERSIBLE, SELF-PRIMING PLATED BRASS TRANSFER PUMPS

- 1/10 HP, 115 V, 60 Hz, 1.6 Amps motor
- 360 GPH @ 1"
- Self-priming for instant delivery or de-watering up to 6'
- Non-submersible plated brass pump body
- Rugged metallic handle for easy portability
- Dual threaded intake and discharge with both 3/4" male garden hose thread and 3/8" FNPT
- Includes: pump, hose, strainer and suction adapter

**Model No. DC293**

**Price/Each \$455.00**

### PUMP ONLY

**Model No. DC196**

**Price/Each \$335.00**



## CONTRAFLEX WATER DISCHARGE HOSES

- Extremely durable hose
- Layflat design for easy handling
- 25' and 50' lengths with C and E cam and groove fittings assembled



Model No.	Size	Price /Each
TEB656	1.5" x 25'	359.00
TEB651	1.5" x 50'	329.00
TEB657	2" x 25'	469.00
TEB652	2" x 50'	335.00
TEB658	2.5" x 25'	595.00

Model No.	Size	Price /Each
TEB653	2.5" x 50'	1109.00
TEB659	3" x 25'	705.00
TEB654	3" x 50'	525.00
TEB660	4" x 25'	925.00
TEB655	4" x 50'	745.00

## ALUMINUM CAM & GROOVE FITTINGS

- Simple to use quick connect fittings
- Very reliable and durable



Size"	Part A	Price /Each	Part B	Price /Each	Part C	Price /Each	Part D	Price /Each	Part E	Price /Each	Part F	Price /Each
1	WL016	5.69	WL027	16.50	WL038	12.50	WL049	13.50	WL060	6.29	WL071	7.39
1 1/4	WL017	7.49	WL028	19.90	WL039	17.50	WL050	19.50	WL061	8.99	WL072	10.90
1 1/2	WL018	6.79	WL029	16.50	WL040	16.50	WL051	16.50	WL062	8.29	WL073	9.09
2	WL019	7.79	WL030	17.50	WL041	17.90	WL052	17.90	WL063	10.50	WL074	10.90
2 1/2	WL020	17.90	WL031	30.50	WL042	30.50	WL053	30.50	WL064	22.90	WL075	23.90
3	WL021	14.50	WL032	30.50	WL043	34.50	WL054	32.50	WL065	19.90	WL076	20.50
4	WL022	22.90	WL033	44.90	WL044	50.50	WL055	44.90	WL066	33.50	WL077	33.50

## PVC SUCTION & DISCHARGE HOSES

- Excellent weather and abrasion resistance
- Perfect for construction pumps, trash pumps, mining and quarry use
- 25' lengths with C Cam, Groove fitting and combination nipple fully assembled
- Hoses 1 1/2" and over come with an assembled basket strainer



Model No.	Size"	Price/Each
TEB644	1	135.00
TEB645	1.25	155.00
TEB646	1.5	205.00
TEB647	2	285.00
TEB648	2.5	379.00
TEB649	3	495.00
TEB650	4	829.00

# LADDERS & SCAFFOLDING

## INDUSTRIAL EXTRA HEAVY-DUTY STEP STOOL/LADDERS

CSA grade 1A, ANSI type 1A 300-lb. Load Rating

- Super tough copolymer top for strength and durability
- Both front and rear legs are braced
- Solid aluminum rivets in front prevent steps from loosening
- Slip resistant vinyl feet

**FEATHERLITE**  
INDUSTRIAL LADDERS



Model No.	Nominal Height'	Base Width"	Spread"	Wt. lbs.	Price /Each
VC239	2	15 1/2	17 1/2	5	96.50

## INDUSTRIAL-DUTY ALUMINUM SAWHORSE

- Engineered to allow for convenient mixing of sizes in plank applications
- Durable extruded aluminum steps and side rails, serrated for strength and safety
- Trestle design allows safe access from either side
- J-shaped spreaders for easy set-up and storage
- Heavy-duty rubber safety shoes
- Capacity: 250 lbs.



**FEATHERLITE**  
INDUSTRIAL LADDERS

Model No.	Nominal Height'	Open Height"	Base Width"	Base Depth"	Wt. lbs.	Price /Each
VC010	2	23	32	24.5	10	185.00
VC011	3	35	33	32	14	219.00
VC012	4	47.5	34.5	34.5	19	289.00

## ALUMINUM TELESCOPIC LADDERS

- Compact and easy to move, use and store
- Extends and locks in 12" increments
- Indicators let you know when the rungs are locked into place
- Anti-slip rungs
- Capacity: 250 lbs.
- CSA grade 1

VC441



**METALTECH**

Model No.	Height'	Reach'	Closed Dimensions W" x D" x H"	Weight Colour lbs.	Price /Each
VC441	12	16	19 x 4.5 x 32	Yellow 25	485.00
VC252	15	19	19.5 x 4.5 x 36	Blue 37	649.00

\* Other sizes available

## PORTABLE WORK-STAND SAW HORSE

- Use it as a stepladder for hard-to-reach areas, or combine two work stands sawhorse with an extendable plank for a sturdy, reliable scaffold
- Non-slip steps and top
- 300 lbs load capacity
- Lightweight, all-aluminum construction
- Heavy duty no-pinch spreaders
- Slip-resistant feet
- Frame Material: Aluminum



MP913

**METALTECH**

Model No.	Mfg. No.	Overall Height"	Overall Depth"	Price /Each
MP913	E-PWS7000AL	24	12-1/4	209.00
MP914	E-PWS7100AL	36	12-1/4	295.00
MP915	E-PWS7200AL	48	12-1/4	335.00
MP916	E-PWS7300AL	56	12-1/4	429.00

## INDUSTRIAL HEAVY-DUTY FIBREGLASS WORKING PLATFORMS

CSA Grade 1A, ANSI Type 1A, 300-lb. Load Rating

- 12" wide slip-resistant standing platform
- Platform height: 21"
- Platform dimensions: 12" W x 37 1/4" D
- Base Width: 16 1/4"
- Base Depth: 46 7/8"
- Weight: 13 lbs.

Model No. VD404  
Price/Each \$319.00



**LOUISVILLE**  
LADDER

## FIBREGLASS STEP STOOL/LADDERS (6400 SERIES)

CSA Grade 1A, ANSI Type 1A, 300-lb. Load Rating

- Super tough copolymer top for strength and durability
- Slip-resistant serrated aluminum steps
- Extra-large PVC rubber safety boots are heavy-duty and provide increased rail protection and slip-resistance

**FEATHERLITE**  
INDUSTRIAL LADDERS



Model No.	Nominal Height'	Base Width"	Spread"	Approx Weight lbs.	Price /Each
VC211	2	17	17	8	229.00

## HEAVY-DUTY WORKHORSES

- 2000-lb. capacity
- Overbuilt to be the last sawhorse you'll ever need
- Powder coated finish safety yellow



**KLETON** **K**  
CUSTOM

Model No.	Height"	Width"	Depth"	Wt. lbs.	Price /Each
VC157	24	36	20	43	349.00
VC158	36	48	20	57	435.00

## BUILDMAN™ STEP-UP WORKBENCH

- The fiberglass workbench is non-conductive, making it an excellent equipment for all electrical work
- Featuring anti-slip steps, the 2, 3 and 4 foot step-up workbenches provide a safe and comfortable access solution
- Furthermore, these products are characterized by their 300 lb high load capacity and their vibrant orange coating, ensuring enhanced visibility and safety
- Also commonly called trigger benches, they are designed to offer both safety and convenience, making them an ideal choice for your work needs

**METALTECH**



VD701

Model No.	Mfg. No.	Nominal Height'	Width"	Depth"	Price /Each
VD699	E-WFSB24T1A	2	33.5	25.75	191.00
VD700	E-WFSB36T1A	3	34.75	33.25	221.00
VD701	E-WFSB48T1A	4	36.25	40.5	278.00



## STEP STOOL

- Heavy-duty steel
- Comes with a double platform with non-slip rubber tread
- Spring-loaded casters retract under slight pressure, forcing base to the floor
- 11" diameter upper platform and 13 1/2" diameter lower platform
- 17 1/4" diameter base has an all-around protective bumper
- 16 1/2" overall height
- Weight: 10 lbs.
- Colour: Black
- Capacity: 330 lbs.

**Model No. ONS28**  
**Price/Each \$115.00**

**KLETON**



## STEP STOOLS

- Tough 1-piece poly construction with anti-skid bottom
- Threaded top & expanded step
- 16" diameter base provides added stability
- Glides easily on retractable rubber casters
- 13.5" overall height
- Capacity: 350 lbs.
- Weight: 6 lbs.



Model No.	Mfg. No.	Colour	Price /Each
OA299	2523BL	Black	219.00
OA300	2523BE	Beige	219.00

## BIOS™ STEP STOOL LADDER

- Aluminum ladder cart is ideal for home, office or store use
- Strong and lightweight aluminum construction
- Converts from a step stool into a hand truck
- Hand truck nose plate measures 15" wide
- Rolls on 4" diameter wheels
- No. of Steps: 3
- Overall Height: 38 1/2"
- Overall Length: 20"
- Overall Width: 18"
- Ladder Dimension: 14" x 32" x 47"
- Trolley Dimensions: 14 1/2" x 16 1/2" x 50"
- Hand Truck Capacity: 132 lbs.
- Step Stool Capacity: 330 lbs.
- Step Rise: 10"

**Model No. MO009**  
**Price/Each \$175.00**

**BIOS living**



## STEEL STOP-STEP LADDERS

- Spring-loaded swivel casters are protected by a steel dome with rubber bottom pads for extra grip
- Sleek design offers maximum safety and convenience
- Powder coat finish provides a durable attractive appearance
- Frame Material: Steel
- Step Type: Anti-Skid
- Capacity: 300 lbs.
- Colour: White



MO019



MO021

Model No.	No. of Steps	Platform Height"	Step Width"	Platform Depth"	Price /Each
MO019	1	9-9/16	16	11	369.00
MO020	2	18-9/16	16	11	495.00
MO021	3	28-11/16	16	11	705.00
MO022	4	38-3/16	16	11	785.00
MO023	5	47-11/16	16	11	899.00

## PORTABLE FOLDING LADDERS

- Foldable locking design saves on storage space when not in use
- Welded construction
- Easy to maneuver
- 58° slope, 7" deep steps for easy climbing
- Perforated step
- Locks in the folded or climbing positions
- Approximately 10" deep when folded for easy storage
- Maximum Capacity: 350 lbs.

**KLETON**

Model No.	No. of Steps	Top Step Height"	Open W" x L"	Folded Dimensions W" x L" x H"	Wt. lbs.	Price /Each
VC436	2	20	24 x 17	24 x 10 x 41	30	229.00
VC437	3	30	24 x 23	24 x 10 x 52	35	295.00
VC438	4	40	24 x 30	24 x 10 x 65	42	350.00



VC437

## INDUSTRIAL STEP STOOL

- Industrial-duty high density polyethylene is durable and corrosion proof
- Hand holes provide easy lifting locations for manoeuvrability
- Open bottom step design allows for easy stacking for storage while not compromising rigidity
- Stair anti-skid tape provides excellent grip and provides a safe non-slip surface
- Rubber feet improve traction on flat surfaces
- Includes spare replacement rubber feet

### SINGLE STEP

Dimensions:  
20-7/8" L x 12-3/16" W x 14-9/16" H  
Weight: 8.38 lbs.  
**Model No. MP770**  
**Price/Each \$98.50**



### DOUBLE STEP

Dimensions:  
26" L x 22-7/16" W x 19-11/16" H  
Weight: 17.2 lbs.  
**Model No. MP771**  
**Price/Each \$189.00**



### TRIPLE STEP

Dimensions:  
34-13/16" L x 22-7/16" W x 29-1/8" H  
Weight: 26 lbs.  
**Model No. MP772**  
**Price/Each \$296.00**



**KLETON**

## INDUSTRIAL STEP STOOL

- Durable, corrosion-proof, 500-lb. capacity
- Rear opening to access storage compartment
- Hand holes and light weight combine for easy manoeuvrability
- includes rubber feet and non skid tape surface

### QUAD STEP WITH CASTERS

Dimensions:  
43" L x 22 1/2" W x 66" H  
Weight: 53 lbs.  
**Model No. MN644**  
**Price/Each \$1109.00**



**DPI**

## NESTABLE INDUSTRIAL STEP STOOLS

- Durable, nestable and corrosion-proof
- Hand holes and light weight combine for easy manoeuvrability
- All models include rubber feet and non skid tape surface
- Additional ribbing on the top standing surface helps reduce flexibility
- Capacity: 500 lbs.
- Colour: Safety Yellow

**MN656**

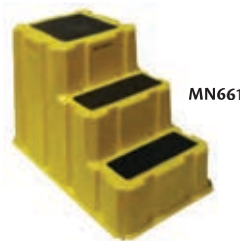

**MN661**

## INDUSTRIAL STEP STOOL

- Durable, nestable, corrosion-proof
- Moulded-in handles make them easy to carry
- Includes rubber feet and a non skid tape surface
- Capacity: 500 lbs.
- Colour: Safety Yellow

**MN532**



Model No.	No. of Steps	Overall Height"	Overall Length"	Overall Width	Price /Each
MN656	1	10-1/2	25	25	260.00
MN657	1	14-3/4	25	25	275.00
MN658	2	20-5	32-3/4	25-3/4	377.00
MN659	2	24	33	25-3/4	388.00
MN661	3	29	42	25-3/4	675.00

**TECHSTAR PLASTICS INC.**

Model No.	Number of Steps	Dimensions L" x W" x H"	Weight lbs.	Price /Each
MN531	1	28 x 20 x 13	10	136.00
MN532	2	36 x 28 x 20	20	246.00

## STEP STANDS

- Rugged all-welded construction
- Rolling stands come with spring-loaded casters
- Dimensions: 16" D x 12" H
- Capacity: 300 lbs.
- Kleton blue enamel finish
- Meets ANSI standard A14.7

**KLETON**



**MH228**



**MH225**

**K CUSTOM**

### PLATFORM STANDS

Model No.	Width"	Wt. lbs.	Price /Each
MH228	20	11	165.00
MH229	24	13	169.00
MH230	32	16	179.00

### ROLLING STANDS

Model No.	Width"	Wt. lbs.	Price /Each
MH225	20	17	285.00
MH226	24	19	295.00
MH227	32	22	309.00

## WORK PLATFORMS

- Solid all-welded construction
- Elevate workers to comfortable working heights
- Provides solid footing around machinery and other work areas
- Capacity: 800 lbs.
- Durable Kleton blue enamel finish
- Meets ANSI standard A14.7

**K CUSTOM**



**VC129**

**KLETON**

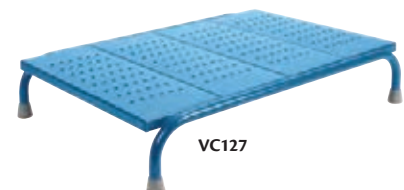

**VC127**

Model No.	Platform Size W" x D"	Top Step Height"	Wt. lbs.	Price /Each
VC127	24 x 32	6	28	249.00
VC128	32 x 32	6	34	279.00
VC129	24 x 32	12	32	275.00
VC130	32 x 32	12	38	299.00

### REPLACEMENT PARTS

Model No.	Description	Price Each
VC055	Rubber Foot Tip	1.95

# LADDERS & SCAFFOLDING

## TILT-N-ROLL STEP STANDS

- Frame is welded 1" round steel tubing
- Non-clogging slip resistant steel steps
- Handle allows step stand to move easily on two 4" casters
- Step Dimensions: 22" x 8"
- Top Step Dimensions: 22" x 16"
- Capacity: 300 lbs.
- Durable Kleton blue enamel finish
- Meets ANSI standard A14.7



VC336



**KLETON**

Model No.	Number of Steps	Top Step Height"	Base Dimensions W" x D"	Wt. lbs.	Price /Each
VC335	1	12	29 x 16	24	309.00
VC336	2	19	29 x 24	33	379.00

## TILT-N-ROLL LADDERS

- Balanced design allows ladder to tilt into the rolling position
- One piece all-welded steel construction
- 30" high rails with 22" wide expanded metal steps
- Oversize 22" x 24" top step for easier worker movement
- Legs have rubber tips that hold ladder secure during use
- Ladder moves easily on two 4" casters
- Capacity: 300 lbs.
- Durable Kleton blue enamel finish
- Meets ANSI standard A14.7



MD603

Optional MH242



Model No.	No. of Steps	Step W" x D"	Rise Height"	Top Step Height"	Top Step W" x D"	Height Top Rail"	Overall Dimensions W" x D" x H"	Wt. lbs.	Price /Each
MD603	3	22 x 8	9	27	22 x 24	30	25 x 44 x 57	70	585.00
MD604	4	22 x 8	9	38	22 x 24	30	25 x 50 x 68	81	679.00
MD605	5	22 x 8	9	47	22 x 24	30	25 x 56 x 77	93	775.00
MD606	6	22 x 8	9	56	22 x 24	30	25 x 62 x 86	105	795.00

## ROLLING STEP STANDS

- Ideal wherever there is a need to reach materials
- Rolls easily into position and locks firmly to the floor for maximum safety
- All the ladders operate on spring-loaded casters
- Casters retract under operator's weight and rubber feet drop down
- Non-clogging slip-resistant steel steps
- Frame is welded 1" round steel tubing
- Capacity: 300 lbs.
- Durable Kleton blue enamel finish
- Meets ANSI standard A14.7



VC131



VC134



**KLETON**

Model No.	Number of Steps	Step Size W" x D"	Top Step Height"	Top Step W" x D"	Base Dim. W" x D"	Wt. lbs.	Price /Each
VC131	2	18 x 8	19	18 x 16	20 x 26	28	339.00
VC132	3	18 x 8	28	18 x 16	20 x 30	38	375.00
VC133	4	18 x 8	37	18 x 16	20 x 37	48	409.00
VC134	5	18 x 8	46	18 x 16	20 x 41	57	469.00

## TRAILER ACCESS ROLLING LADDER

- Provides secure, safe access to cube vans/trailers
- All welded steel construction, ships fully assembled and ready to use
- Front walk through with chain/snap assembly
- Non-clogging slip resistant steps
- 10" flat-free wheels in rear
- Drop down handles in front for easy maneuvering
- Durable Kleton blue enamel finish
- Made in accordance with the ANSI A14.7 safety standard
- Frame Material: Steel
- Step Type: Perforated
- Capacity: 300 lbs.



MO010



Model No.	No. of Steps	Step W" x D"	Platform H" x D"	Overall Dimensions W" x D" x H"	Wt. lbs.	Price /Each
MO010	4	22 x 8	37 x 16	33 x 40 x 78	78	989.00
MO011	5	22 x 8	46 x 16	33 x 46 x 87	89	1015.00
MO012	6	22 x 8	55 x 16	33 x 51 x 96	100	1049.00

## MECHANICS/MAINTENANCE ROLLING LADDERS

- Double-straddle base puts worker in close proximity for hard-to-reach jobs
- Tilt and roll wheelbarrow style mobility allows easy movement over rough surfaces
- Oversize 22" x 24" top step for easier worker movement
- Removable 10" D x 24" W tool tray fits on front or side railing included
- Capacity: 300 lbs.
- Durable Kleton blue enamel finish
- Meets ANSI standard A14.7



MH213

MH242 Included



Model No.	No. of Steps	Step W" x D"	Rise Height"	Top Step Height"	Top Step W" x D"	Height Top Rail"	Overall Dimensions W" x D" x H"	Wt. lbs.	Price /Each
MH212	3	22 x 8	9	28	22 x 24	30	24 x 44 x 58	85	669.00
MH213	4	22 x 8	9	38	22" x 24"	30	24 x 50 x 68	98	769.00
MH214	5	22 x 8	9	47	22 x 24	30	24 x 56 x 77	112	865.00
MH215	6	22 x 8	9	57	22 x 24	30	24 x 68 x 87	125	935.00



## ROLLING STEP LADDERS

- Ideal wherever there is a need to reach bulky materials
- Rolls easily into position and locks firmly to the floor for maximum safety
- 2 to 6 step ladders operate on spring-loaded casters
- Casters retract under operator's weight, rubber feet drop down
- First step on all 8 to 16 step ladders activates the floor locking mechanism (step off and kick release to make the ladder mobile)
- Non-clogging slip-resistant steel steps
- Frame is rugged welded 1" round steel tubing
- 8 to 16 step ladders shipped knocked down, easily assembled
- Capacity: 300 lbs.
- Durable Kleton blue enamel finish
- CSA certified to the ANSI A14.7 standard



**Note:**  
Ladders are not to be used as work platforms.



MA617



MA613



MA615



MA622



MA624

### WITH HANDRAILS

Model No.	Number of Steps	Step Size W" x D"	Top Step Height"	Top Step W" x D"	Base Dimensions W" x D"	Wt. lbs.	Price /Each
<b>SPRING LOADED CASTERS</b>							
MA614	4	22 x 8	37	22 x 16	30 x 36	78	629.00
MA616	5	22 x 8	46	22 x 16	30 x 46	89	665.00
MA617	6	22 x 8	55	22 x 16	30 x 51	100	709.00
<b>NARROW WIDTH, SPRING LOADED CASTERS</b>							
VD441	4	18 x 8	37	18 x 16	26 x 36	73	609.00
VD442	5	10 x 8	46	18 x 16	26 x 46	82	635.00
VD443	6	18 x 8	55	18 x 16	26 x 51	92	679.00
<b>LOCKING STEP</b>							
MA622*	8	30 x 8	72	30 x 16	38 x 60	180	1309.00
MA623*	10	30 x 8	89	30 x 16	38 x 72	230	1409.00
MA624*	12	30 x 8	109	30 x 16	38 x 80	250	1605.00
MA625*	14	30 x 8	128	30 x 16	38 x 93	275	1795.00
MA626*	16	30 x 8	144	30 x 16	38 x 104	305	2089.00

\* Ships knocked down easy assembly

### WITHOUT HANDRAILS

Model No.	Number of Steps	Step Size W" x D"	Top Step Height"	Top Step W" x D"	Base Dimensions W" x D"	Wt. lbs.	Price /Each
MA612	2	22 x 8	19	22 x 16	24 x 26	32	339.00
MA613	3	22 x 8	28	22 x 16	24 x 30	42	375.00
MH279	4	22 x 8	37	22 x 16	24 x 37	52	479.00
MA615	5	22 x 8	46	22 x 16	24 x 41	61	505.00

## HIGH WORK MAINTENANCE PLATFORMS

- Convert forklift truck into safe, efficient work platform
- Take care of overhead maintenance problems without setting up ladders or scaffolds
- Non-skid platform
- 72" safety mesh backscreen keeps operator and equipment away from lift mechanism
- Forks slip easily into pockets and are secured with safety chains
- Load Capacity: 1000 lbs.
- No assembly required

### NOTE:

Kleton maintenance platforms meet or exceed ASME B56.1 safety standard when a safety harness and lanyard are worn.

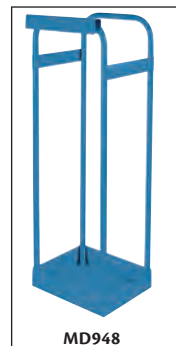

MD948



MD444

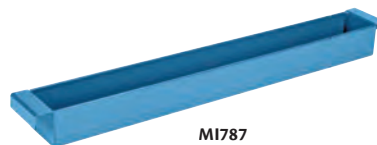

M1787

Model No.	Description	Wt. lbs.	Price/Each
MD444	High Work Platform - 36" x 36" platform	230	1349.00
MH800	High Work Platform - 48" x 48" platform	300	1879.00
MD338	Optional 6" Caster Kit	10	193.00
MD948*	Light Bulb Caddy 15" W x 15" D x 43" H	25	375.00
<b>OPTIONAL TOOL TRAYS</b>			
M1787	36" L x 4" W x 3" D, Fits on model MD444	-	175.00
M1788	48" L x 4" W x 3" D, Fits on model MH800	-	179.00

# LADDERS & SCAFFOLDING

## WHAT HEIGHT?

### STEPLADDER

Max. Height You Want to Reach*	Buy This Size
7'	4'
8'	5'
9'	6'
10'	7'
11'	8'
12'	10'
14'	12'
16'	14'
18'	16'
20'	18'
22', 24'	20'

\*Assumes a 5' 6" person with a vertical 12" reach.

### EXTENSION/STRAIGHT LADDERS

Height of Top Support Point	Buy This Size*
9' max.	16'
9' to 13'	20'
13' to 17'	24'
17' to 21'	28'
21' to 25'	32'
25' to 28'	36'
28' to 31'	40'

\*Reflects section overlap, ladder angle.

## WHAT LOAD CAPACITY?

### Formula:

Your Weight



Load Capacity

### Material Weight

Typically Add:  
**75 lbs.** For Heavy-Duty Projects  
**50 lbs.** For Light-Duty Projects



200 lbs.	CSA grade 3 Household
225 lbs.	CSA grade 2 Tradesman and Farm
250 lbs.	CSA grade 1 Construction and Industrial
300 lbs.	CSA grade 1A Construction and Industrial meets ANSI Type1A, Industrial Heavy Duty
375 lbs.	CSA grade 1AA Construction and Industrial meets ANSI Type1AA, Industrial Heavy Duty

## COMMERCIAL DUTY ALUMINUM STEPLADDERS (2400 SERIES)

CSA grade 2,

ANSI type 2 – 225-lb. Load Rating

- Super tough molded copolymer utility top
- Durable yet light-weight extruded side rails
- 3" slip-resistant serrated steps
- Heavy-duty rubber safety shoes

MF064



**FEATHERLITE**  
INDUSTRIAL LADDERS

Model No.	Nominal Height'	Open Height"	Highest Standing Height"	Base Width"	Base Depth"	Weight lbs.	Price /Each
MF063	4	45	24	18	31	9	155.00
MF064	6	67	45	21	44	13	235.00
MF065	8	90	67	23	56	19	299.00
VC459	10	114	92	28	69	26	429.00

## INDUSTRIAL EXTRA HEAVY-DUTY ALUMINUM STEPLADDERS (3400 SERIES)

CSA grade 1A,

ANSI type 1A – 300-lb. load rating

High strength to weight ratio provides an economical alternative for general contract work

- Super tough copolymer top for strength and durability
- Wide 3" slip-resistant serrated aluminum steps for safe climbing
- Rugged outside zinc coated steel spreader arms
- 10" x 10" heavy-duty hinged utility tray for holding tools and paint accessories
- Heavy-duty slip-resistant safety shoes

VC241



**FEATHERLITE**  
INDUSTRIAL LADDERS

Model No.	Nominal Height'	Open Height"	Highest Standing Point"	Base Width"	Base Depth"	Weight lbs.	Price /Each
VC241	4	46	23	18	30	11	235.00
VC243	6	68	45	21	43	16	325.00
VC244	8	91	68	24	55	21	465.00
VC245	10	114	91	27	68	27	675.00
VC315	12	137	114	32	78	38	919.00

## SAFETY DO'S

- Keep your body centred on the ladder. Hold the ladder with one hand while working with the other hand whenever possible. Never let your belt buckle pass beyond either ladder rail



- Move materials with extreme caution. Be careful pushing or pulling anything while on a ladder. You may lose your balance or tip the ladder



# TOOLS THAT MEASURE UP!

**AURORA**  
TOOLS

## SAFETY DO'S

### Care & Maintenance

- Inspect the rails of Fibreglass Ladders for weathering due to UV (ultraviolet) exposure.
- Keep the ladder protected from heat, weather, and corrosive materials.



### Safety Before You Climb

- Use fiberglass ladders if there is even a remote possibility of working near electricity or overhead power lines. Fibreglass is electrically non-conductive.
- NEVER use metal, water logged or dirty wood ladders near electricity!



## INDUSTRIAL DUTY FIBREGLASS STEPLADDERS (6300 SERIES)

CSA grade 1,

ANSI type 1, 250-lb. load rating

- Durable non-conductive "C" channel front rails
- Equipped with a molded top
- Heavy-duty gusset bracing
- Pinch-resistant spreader braces and wide back braces
- Double-rivet step construction



VC025

**FEATHERLITE**  
INDUSTRIAL LADDERS

Model No.	Nominal Height'	Open Height"	Highest Standing Height"	Base Width"	Base Depth"	Approx Weight lbs.	Price /Each
VC023	4	46	23	20	30	17	239.00
VC024	5	57	34	21	34	18	259.00
VC025	6	68	45	23	43	20	275.00
VC027	8	90	67	26	55	26	349.00

## INDUSTRIAL HEAVY-DUTY FIBREGLASS STEPLADDERS (6900 SERIES)

CSA grade 1A,

ANSI type 1A, 300-lb. load rating

- Durable non-conductive "C" channel side rails in high visibility safety yellow
- Super tough copolymer utility top
- Wide 3" slip-resistant serrated aluminum steps for safe climbing
- Inside spreader arms complete with "wrap-around" sleeves
- Rear "L" horizontal struts every 12" with top and bottom struts reinforced with zinc coated steel diagonal braces
- Extra-large PVC rubber safety boots are heavy-duty and provide rail protection and slip-resistance



MF609

**FEATHERLITE**  
INDUSTRIAL LADDERS

Model No.	Nominal Height'	Open Height"	Highest Standing Height"	Base Width"	Base Depth"	Approx Weight lbs.	Price /Each
MF607	4	45	23	19	28	14	255.00
MF609	6	68	45	21	39	20	295.00
MF611	8	90	67	24	51	26	365.00
MF612	10	113	90	26	61	37	539.00
MF613	12	135	112	29	74	48	635.00

## INDUSTRIAL HEAVY-DUTY FIBREGLASS STEPLADDERS (6400 SERIES)

CSA grade 1A,

ANSI type 1A, 300-lb. load rating

- Durable non-conductive "C" Channel side rails in high visibility safety yellow
- Super tough copolymer utility top for strength and durability
- Slip-resistant serrated aluminum steps
- Inside spreader arms complete with "wrap-around" brackets to strengthen spreader to rail connection
- Rear horizontal struts every 12" with top and bottom struts reinforced with zinc coated steel diagonal braces
- Full rear "L" horizontal struts reinforced with zinc coated steel diagonal braces
- Extra-large PVC rubber safety boots are heavy-duty and provide increased rail protection and slip-resistance



MD490

**FEATHERLITE**  
INDUSTRIAL LADDERS

Model No.	Nominal Height'	Open Height"	Highest Standing Height"	Base Width"	Base Depth"	Approx Weight lbs.	Price /Each
VC211	2	24	11	17	17	8	229.00
MD488	4	46	23	20	28	15	275.00
MD490	6	68	45	23	39	23	329.00
MD491	8	90	67	26	50	30	399.00
MD492	10	113	90	29	61	38	625.00
MD493	12	137	114	32	74	52	749.00

## INDUSTRIAL EXTRA HEAVY-DUTY FIBREGLASS STEPLADDERS (6800 AA SERIES)

CSA grade 1AA,

ANSI type 1AA, 375-lb. load rating

- Extra strong non-conductive "C" channel side rails in high visibility orange
- Super tough copolymer utility top for strength and durability
- Wide 3" slip-resistant serrated aluminum steps for safe climbing
- Inside spreader arms complete with "wrap-around" sleeves that strengthen spreader-to-rail connection and protect spreader arms during storage/loading/transit
- Each step is double braced with zinc coated steel diagonal braces providing incredible strength and stiffness
- Full rear "L" horizontal struts reinforced with zinc coated steel diagonal braces offer maximum rigidity
- Heavy-duty aluminum "wrap-around" sleeves at base of rails for maximum protection



VC256

**FEATHERLITE**  
INDUSTRIAL LADDERS

Model No.	Nominal Height'	Open Height"	Highest Standing Height"	Base Width"	Base Depth"	Approx Weight lbs.	Price /Each
VC254	4	46	23	20	28	15	329.00
VC256	6	68	45	23	39	27	439.00
VC258	8	90	67	25	50	35	579.00
VC259	10	113	90	29	61	44	749.00
VC260	12	136	113	31	72	59	919.00



# LADDERS & SCAFFOLDING

## INDUSTRIAL HEAVY-DUTY FIBREGLASS PLATFORM STEPLADDERS (6500 SERIES)

CSA grade 1A ,

ANSI type 1A, 300-lb. load rating

- Durable non-conductive "C" channel side rails in high visibility safety yellow
- Large safe and comfortable standing platform, 14" x 18"
- Wide 3" slip-resistant serrated aluminum steps for safe climbing
- Rugged outside zinc coated steel spreader arms
- Each step reinforced with zinc coated steel diagonal braces providing strength and stiffness
- Rear horizontal struts reinforced with zinc coated steel brace offer maximum rigidity
- Heavy-duty slip-resistant safety shoes



VC205

**FEATHERLITE**  
INDUSTRIAL LADDERS

Model No.	Nominal Height'	Open Height"	Platform Height"	Base Width"	Base Depth"	Approx. Weight lbs.	Price /Each
VC205	4	46	24	21	30	17	335.00
VC206	5	57	35	23	36	22	405.00
MF411	6	68	46	24	42	25	459.00
MF412	8	90	68	26	53	33	565.00
MF413	10	113	92	29	67	41	669.00
VC207	12	135	115	31	75	50	789.00

## INDUSTRIAL EXTRA HEAVY-DUTY FIBREGLASS PLATFORM STEPLADDER (6500 AA SERIES)

CSA grade 1AA ,

ANSI type 1AA, 375-lb load rating

- Extra strong non-conductive "C" channel side rails in high visibility safety orange
- Large safe and comfortable standing platform, 14" x 18"
- Wide 3" slip-resistant serrated aluminum steps for safe climbing
- Heavy-duty aluminum "wrap-around" sleeves at base of rails
- Rugged outside zinc coated steel spreader arms
- Each step reinforced with zinc coated steel diagonal braces providing strength and stiffness



VC223

**FEATHERLITE**  
INDUSTRIAL LADDERS

Model No.	Nominal Height'	Open Height"	Platform Height"	Base Width"	Base Depth"	Approx. Weight lbs.	Price /Each
VC223	4	46	24	20	38	24	389.00
VC224	5	57	35	22	47	28	459.00
VC225	6	68	46	23	56	32	505.00
VC226	8	90	68	26	72	48	635.00
VC227	10	113	92	29	91	57	775.00
VC228	12	135	115	32	109	66	975.00

## INDUSTRIAL HEAVY-DUTY FIBREGLASS 2-WAY STEPLADDERS (6600 SERIES)

CSA grade 1A ,

ANSI type 1A, 300-lb. load rating

Double front construction allows two climbers to access the ladder from opposite sides

- Durable non-conductive C channel side rails in high visibility safety yellow
- Wide aluminum top with extra-thick brackets for strength and durability
- Wide 3" slip-resistant serrated aluminum steps for safe climbing
- Inside spreader arms complete with "wrap-around" sleeves that strengthen spreader-to-rail connection and protect spreader arms during storage/loading/transit
- Every other step is reinforced with zinc coated steel diagonal braces providing extra rigidity
- Extra-large PVC rubber safety boots are heavy-duty and provide rail protection and slip-resistance



MF414

**FEATHERLITE**  
INDUSTRIAL LADDERS

Model No.	Nominal Height'	Open Height"	Highest Standing Height"	Base Width"	Base Depth"	Approx. Weight lbs.	Price /Each
VC214	4	45	23	20	38	19	389.00
MF414	6	67	45	23	56	26	519.00
MF415	8	90	67	26	72	36	665.00
MF416	10	112	89	29	91	46	829.00

## INDUSTRIAL EXTRA HEAVY-DUTY FIBREGLASS 2-WAY STEPLADDERS (6600 AA SERIES)

CSA grade 1AA ,

ANSI type 1AA, 375-lb. load rating

- Extra strong non-conductive C channel side rails in high visibility safety orange
- Double front construction allows access from either side
- Extra strength fibreglass side rails in high visibility safety orange
- Redesigned super-tough top bracket system for even greater stability
- Slip-resistant 3" aluminum steps
- Heavy-duty aluminum "wrap-around" sleeves at base of rails



VC219

**FEATHERLITE**  
INDUSTRIAL LADDERS

Model No.	Nominal Height'	Open Height"	Highest Standing Height"	Base Width"	Base Depth"	Approx. Weight lbs.	Price /Each
VC218	4	45	23	20	38	19	445.00
VC219	6	67	45	23	56	26	599.00
VC220	8	90	67	26	72	36	755.00
VC221	10	112	89	29	91	46	945.00
VC222	12	135	112	32	109	58	1165.00

## INDUSTRIAL HEAVY-DUTY FIBREGLASS PRO PLATFORM STEPLADDERS (FXP1700 SERIES)

CSA Grade 1A, ANSI Type 1A, 300-lb. Load Rating

- Super tough copolymer utility top includes multiple tool slots
- Durable non-conductive "C" channel side rails in high visibility safety orange
- Platform dimensions: 14 3/4" W x 21" D
- Utility top is 30" above the platform
- Wide 3" slip-resistant serrated aluminum steps for safe climbing
- Heavy-duty slip-resistant safety shoes
- Rugged outside zinc-coated steel spreader arms



VD407



Model No.	Nominal Height'	Open Height"	Platform Height"	Base Width"	Base Depth"	Approx. Wt. lbs.	Price /Each
VD405	4 1/2	53 1/4	24	21 1/4	32 5/8	18	405.00
VD406	5 1/2	64 5/8	34	23 1/3	38 5/8	22	459.00
VD407	6 1/2	76	46	24 4/5	44 4/7	24	499.00
VD409	8 3/4	97 7/8	68	27 3/4	56 4/9	30	605.00
VD410	10 1/2	121 3/4	96	30 7/8	68 1/4	46	809.00
VD411	12 1/2	144 1/2	120	33 4/5	80 1/8	60	979.00
VD412	14 1/2	167 1/2	144	36 4/5	92	72	1245.00

## INDUSTRIAL EXTRA HEAVY-DUTY FIBREGLASS PRO PLATFORM STEPLADDERS (FXP1800 SERIES)

CSA Grade 1AA, ANSI Type 1AA, 375-lb. Load Rating

- Super tough copolymer utility top includes multiple tool slots
- Durable non-conductive "C" channel side rails in high visibility safety orange
- Platform dimensions: 14 3/4" W x 21" D
- Utility top is 3' above the platform
- Wide 3" slip-resistant serrated aluminum steps for safe climbing
- Heavy-duty slip-resistant safety shoes
- Rugged outside zinc-coated steel spreader arms



VD413



Model No.	Nominal Height'	Open Height"	Platform Height"	Base Width"	Base Depth"	Wt. lbs.	Price /Each
VD413	5	57 5/8	24	21 1/4	32 5/8	19	515.00
VD414	6	69 1/8	34	23 1/3	38 5/8	23	575.00
VD415	7	80 1/2	46	24 4/5	44 4/7	25	665.00
VD417	9	103 3/8	72	27 3/4	56 4/9	31	775.00
VD418	11	127	96	30 7/8	68 1/4	47	1045.00
VD419	13	149	120	33 4/5	80 1/8	61	1279.00
VD420	15	172 3/8	144	36 4/5	92	73	1635.00

## INDUSTRIAL HEAVY-DUTY ALUMINUM EXTENSION/STRAIGHT LADDERS

CSA grade 1A,

ANSI type 1A – 300-lb. Load Rating

- Heavy-duty "C" channel construction
- Side rails: 2 1/2" x 1" for straights up to 14'
- Side rails: 3" x 1" for straights up to 16' and up
- Heavy-duty serrated "D" rungs prevent slipping for safe and sure climbing
- Black ABS, high impact, non-marking end caps
- Heavy-duty safety shoes



VC276



Model No.	Nominal Length'	Working Length'	Outside Width"	Wt. lbs.	Price /Each
<b>STRAIGHT LADDERS (3100D SERIES)</b>					
VC273	8	-	17 3/4	12	255.00
VC274	10	-	17 3/4	14	309.00
VC275	12	-	17 3/4	18	365.00
VC276	14	-	17 3/4	21	409.00
VC277	16	-	17 3/4	24	475.00
VC278	18	-	17 3/4	27	529.00
VC279	20	-	17 3/4	30	579.00

Model No.	Nominal Length'	Working Length'	Outside Width"	Wt. lbs.	Price /Each
<b>EXTENSION LADDERS (3200D SERIES)</b>					
VC322	16	13	17 3/4	31	475.00
VC323	20	17	17 3/4	36	575.00
VC324	24	21	17 3/4	43	675.00
VC325	28	25	17 3/4	51	769.00
VC326	32	29	17 3/4	58	869.00
VC327	36	32	17 3/4	69	1105.00
VC328	40	35	17 3/4	77	1419.00

## INDUSTRIAL HEAVY-DUTY ALUMINUM EXTENSION/STRAIGHT LADDERS

CSA grade 1A,

ANSI type 1A – 300-lb. Load Rating

- Rigid box section side rails, unequalled for strength and durability
- Side-mounted rope pulley and slide guide system keeps rope clear of climbers feet and allows easy raising (only on 4200D Series)
- Yellow ABS, high impact non-marring end caps
- Premium heavy-duty rung locks (Only 4200D Series)
- Slip-resistant serrated "D" rungs for safe climbing and comfort (round rung on 4100 Series)
- Heavy-duty ribbed swivel feet with ice pick



Series 4100

Series 4200D



Model No.	Nominal Length'	Working Length'	Outside Width"	Wt. lbs.	Price /Each
<b>STRAIGHT LADDERS (4100 SERIES)</b>					
MD506	8	-	14 5/8	13	259.00
MD507	10	-	14 5/8	16	315.00
MD508	12	-	14 5/8	19	365.00
MD509	14	-	14 5/8	22	415.00
MD510	16	-	14 5/8	25	479.00
MD511	18	-	14 5/8	28	535.00
MD512	20	-	14 5/8	31	585.00
MD514	24	-	15 3/4	44	879.00

Model No.	Nominal Length'	Working Length'	Outside Width"	Wt. lbs.	Price /Each
<b>EXTENSION LADDERS (4200D SERIES)</b>					
VC033	16	13	17	29	649.00
VC034	20	17	17	37	765.00
VC035	24	21	17	44	879.00
VC036	28	25	17	50	1015.00
VC037	32	29	18 1/2	69	1135.00
VC038	36	32	18 1/2	78	1415.00
VC039	40	35	18 1/2	86	1675.00
VC040	44	39	18 1/2	94	1839.00

### The following three causes are responsible for over 94% of all ladder accidents:

- A person overreaches and the ladder tips sideways
- A person does not transfer their weight properly when moving from a roof to the ladder, resulting in the ladder falling
- The base of the ladder slips outward while someone is standing on the ladder

# LADDERS & SCAFFOLDING

## INDUSTRIAL HEAVY-DUTY FIBREGLASS EXTENSION LADDERS (6900 SERIES)

CSA grade 1A ,

ANSI type 1A, 300-lb. load rating

- Durable non-conductive fiberglass side rails in high visibility safety yellow
- Rung through rail design
- Slip-resistant serrated "D" rungs for safe climbing and comfort
- Black ABS, high impact non-marring end caps
- Large heavy duty pivot feet with slip-resistant rubber pads and ice pick

**FEATHERLITE**  
INDUSTRIAL LADDERS

Model No.	Nominal Height'	Max. Open Height'	Base Section		Fly Section		Wt. lbs.	Price /Each
			Outside Width"	Inside Width"	Outside Width"	Inside Width"		
VC329	16	13	17 1/8	14 3/4	16 1/8	13 3/4	34	495.00
VC330	20	17	17 1/8	14 3/4	16 1/8	13 3/4	43	579.00
VC331	24	21	17 1/8	14 3/4	16 1/8	13 3/4	51	709.00
VC332	28	25	17 1/8	14 3/4	16 1/8	13 3/4	58	765.00
VC333	32	32	17 1/8	14 3/4	16 1/8	13 3/4	65	859.00



## INDUSTRIAL EXTRA HEAVY-DUTY FIBREGLASS EXTENSION LADDERS (9200 D SERIES)

CSA grade 1AA ,

ANSI type 1AA, 375 lb. load rating

- Durable non-conductive fiberglass side rails in high visibility safety yellow
- Riveted rung to rail design maintains continuous strength of fibres and allows for easy repair
- Slip-resistant serrated "D" rungs for safe climbing and comfort
- Traditional raise from the rear pulley design
- Premium heavy-duty rung locks for durability
- Large heavy-duty pivot feet with slip-resistant rubber pads and ice pick

**FEATHERLITE**  
INDUSTRIAL LADDERS

Model No.	Nominal Height'	Max. Open Height'	Base Section		Fly Section		Wt. lbs.	Price /Each
			Outside Width"	Inside Width"	Outside Width"	Inside Width"		
VC465	16	13	17 3/8	15	16 5/8	14 1/4	39	879.00
VC466	20	17	17 3/8	15	16 5/8	14 1/4	46	1009.00
VC467	24	21	17 3/8	15	16 5/8	14 1/4	55	1155.00
VC468	28	25	17 3/8	15	16 5/8	14 1/4	62	1309.00
VC469	32	28	17 3/8	15	16 5/8	14 1/4	70	1465.00
VC463	36	32	17 3/4	15 1/4	16 7/8	14 1/4	80	2109.00
VC464	40	35	17 3/4	15 1/4	16 7/8	14 1/4	90	2295.00



## INDUSTRIAL HEAVY-DUTY FIBREGLASS EXTENSION LADDERS (6200 SERIES)

CSA grade 1AA ,

ANSI type 1AA, 375-lb load rating

- Durable non-conductive fiberglass side rails in high visibility safety yellow
- Riveted rung to rail design maintains continuous strength of fibres and allows for easy repair
- Slip-resistant serrated rungs for safe climbing (available in round or "D" profile)
- Top cross over bar allows for ladder to be raised or lowered from front and provides tensional stiffness
- Premium heavy-duty rung locks for durability
- Exclusive "1-piece" foot assembly with spur wheel provides unequalled strength, durability and torsion resistance

**FEATHERLITE**  
INDUSTRIAL LADDERS

Model No.	Nominal Height'	Max. Open Height'	Base Section		Fly Section		Wt. lbs.	Price /Each
			Outside Width"	Inside Width"	Outside Width"	Inside Width"		
<b>ROUND RUNG</b>								
MF405	16	13	17 3/8	15	16 5/8	14 1/4	38	779.00
MF406	20	17	17 3/8	15	16 5/8	14 1/4	44	895.00
MF408	24	21	17 3/8	15	16 5/8	14 1/4	52	1025.00
MF409	28	25	17 3/8	15	16 5/8	14 1/4	59	1159.00
MF410	32	28	17 3/8	15	16 5/8	14 1/4	66	1299.00
<b>D RUNG</b>								
MF385	16	13	17 3/8	15	16 5/8	14 1/4	39	779.00
MF386	20	17	17 3/8	15	16 5/8	14 1/4	46	985.00
MF388	24	21	17 3/8	15	16 5/8	14 1/4	55	1125.00
MF389	28	25	17 3/8	15	16 5/8	14 1/4	63	1275.00
MF390	32	28	17 3/8	15	16 5/8	14 1/4	70	1435.00



## INDUSTRIAL EXTRA HEAVY-DUTY STRAIGHT LADDERS (5600 SERIES)

CSA grade 1AA ,

ANSI type 1AA-375 lbs. Load Rating

- Durable non-conductive fiberglass side rails in high visibility safety yellow
- Riveted rung to rail design maintains continuous strength of fibres and allows for easy repair
- Slip-resistant serrated rungs for safe climbing
- Black ABS, high impact non-marring end caps
- Large heavy-duty pivot feet with slip-resistant rubber pads and ice pick

**FEATHERLITE**  
INDUSTRIAL LADDERS

Model No.	Nominal Height'	Outside Width"	Inside Width"	Wt. lbs.	Price /Each
<b>D RUNG</b>					
VC268	8	17 3/8	15	18	445.00
VC269	10	17 3/8	15	21	519.00
VC270	12	17 3/8	15	24	595.00
VC271	14	17 3/8	15	28	669.00
VC272	16	17 3/8	15	31	755.00



## LADDER GUARDS

- Ideal to use on most fiberglass, aluminum, and single ladders
- Material: Urethane
- Colour: Yellow

Model No. VD436  
Mfg. No. LP-5510-00  
Price/Each \$31.50



**LOUISVILLE**  
LADDER

## LADDER LEVELERS

- Leveler for all Louisville fiberglass ladders
- Attaches easily to Type I, IA, IAA ladders
- Extends up to a full 10 inches, perfect for steps
- Large heavy duty swivel shoe with spurs
- Patented KeyLok quick connect system

Model No. MO013  
Mfg. No. LP-2220-01  
Price/Each \$355.00



**LOUISVILLE**  
LADDER



## MOBILE WORK SCAFFOLDING

Meets CSA & OSHA standards

### MINI™ ALUMINUM SCAFFOLDING

- Multi-level working area
- Light aluminum frame
- Anti-slip 16-gauge steel platform adjust every 12", comes with 2 platforms
- Structure: Aluminum alloy 6061-T6 of 1.5"
- Dimensions: 3' 1/2" L x 1' 3/4" W x 4' 1/4" H
- Capacity: 600 lbs.
- Weight: 40 lbs.

**Model No. VC031**

**Price/Each \$359.00**

#### Accessories:

**VC199** Anti-Slip Platform **Price/Each \$67.90**

**MP215** 4" locking casters **Price/Each \$89.50**



### MAXI ROUND SCAFFOLDING

- Multi-level working area
- 16-gauge steel frame painted using a polyester powder coating
- Anti-slip painted 14-gauge steel platform adjust every 4", comes with 3 platforms
- Dimensions: 6' 3" L x 2' 5" W x 6' 4" H
- Capacity: 700 lbs.
- Weight: 140 lbs.

**Model No. MB086**

**Price/Each \$649.00**

#### ACCESSORIES

Model No.	Description	Price/Each
MB087	3' Vertical extension	519.00
MB089	Set of 4 5" casters	155.00
VC200	Anti-Slip Platform	129.00
VC201	Set of 4 outriggers w/casters	305.00



MB086

### MAXI SQUARE SCAFFOLDING

- Heavy-duty all task equipment
- Can be used in stairways
- Square steel tube 1 1/2"sq. frame painted using a polyester powder coating 5/8" plywood platform with protective steel edge banding adjusts every 2", comes with 1 platform
- Dimensions: 74" L x 29" W x 74" H
- Capacity: 1000 lbs.
- Weight: 129 lbs.

**Model No. VC198**

**Price/Each \$479.00**



VC198

### MAXI SQUARE ALUMINUM SCAFFOLDING

- Lightness and sturdiness
- Can be used in stairways
- Anodized aluminum tube 1 1/2"sq. frame
- Anti-slip anodized aluminum platform adjusts every 2", comes with 1 platform
- Dimensions: 6' 2" L x 2' 5" W x 6' 3" H
- Capacity: 700 lbs.
- Weight: 90 lbs.

**Model No. VC032**

**Price/Each \$1039.00**

Model No.	Description	Price/Each
VC203	Set of 4 steel outriggers with 5" casters	305.00
MN560	Set of 4 aluminum outriggers with 5" casters	339.00
VC202	5" Swivel caster with locking system	29.50
VC204	Guardrail system	395.00



VC032

### SPEEDY MOBILE FIBREGLASS SCAFFOLDING

#### Features:

- Non-conductive
- Light weight (91 lbs.)
- Corrosion resistant
- Prevent static electricity
- Anti-slip platform
- Easily assembled
- Compact storage
- Reach 10' 6"
- 500-lb. capacity

**Model No. VC197**

**Price/Each \$3500.00**

#### Ideal for:

- Electricity substation
- Railway stations
- Building sites
- Mechanical rooms
- Chemical environment
- Computer rooms
- Foundries
- Aircraft maintenance
- Mines
- Size: 79 1/2" L x 29 1/2" W x 78" H



VC197



# LADDERS & SCAFFOLDING

## SCAFFOLDING

Meets OSHA and CAN/CSAS269.2-M87. End frames include coupling and spring pins for stacking. The frame's perimeter tubing is 1 11/16" outside diameter, 13 gauge and the interior tubing is 1" diameter, 16 gauge. Anti-slip blue baked-on powder coat for improved durability. Galvanized cross braces are made of 1", 16 gauge tubular steel. Includes 2 end frames and 2 cross braces or build your own scaffold from components offered on the next page.



**Note: Please go to next page to see components and accessories for this product**

		COMPONENTS								
Model No.	Size (L" x W" x H")	MF697 END FRAME 60" L X 36" H SCAFFOLDING	MF698 END FRAME 30" L X 60" H SCAFFOLDING	MF699 END FRAME 60" L X 60" H SCAFFOLDING	MF700 CROSS BRACES 1" DIA. 84" W X 24" H GALVANIZED 16GA	MF701 CROSS BRACES 1" DIA. 84" W X 48" H GALVANIZED 16GA	MF702 CROSS BRACES 1" DIA. 120" W X 24" H GALVANIZED 16GA	MF703 CROSS BRACES 1" DIA. 120" W X 48" H GALVANIZED 16GA	Wt. Lbs.	Price /Each
MP507	84 x 60 x 36	2	-	-	2	-	-	-	82	389.00
MF692	84 x 30 x 60	-	2	-	-	2	-	-	80	369.00
MP508	84 x 60 x 60	-	-	2	-	2	-	-	104	399.00
MF694	120 x 60 x 36	2	-	-	-	-	2	-	90	409.00
MP509	120 x 30 x 60	-	2	-	-	-	-	2	88	409.00
MP510	120 x 60 x 60	-	-	2	-	-	-	2	112	419.00

## COMPONENTS

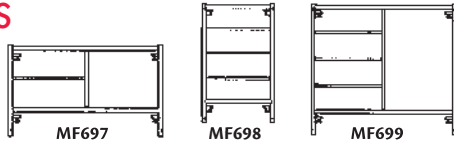

END FRAMES

Model No.	Width"	Height"	Wt. lbs.	Price/Each
MF697	60	36	32	145.00
MF698	30	60	31	139.00
MF699	60	60	43	149.00

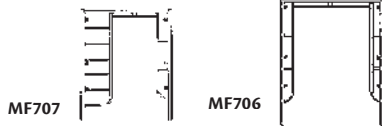

ARCHS

Model No.	Width"	Height"	Wt. lbs.	Price/Each
MF706	60	78	41	279.00
MF707	60	78	45	325.00



### CROSS BRACES

One cross brace must be installed at each end frame or arch for maximum stability. 1" diameter, 16 gauge galvanized tubing.

Model No.	W"	H"	Wt. lbs.	Price/Each
MF700	84	24	9	53.90
MF701	84	48	10	49.50
MF702	120	24	13	63.50
MF703	120	48	14	65.50

### DIAGONAL BRACES

Diagonal braces must be installed on free-standing and wall mounted scaffolds. 1" diameter, 16 gauge galvanized tubing.

Model No.	W"	H"	Wt. lbs.	Price/Each
MF713	84	30	5	41.50
MF716	84	60	6	34.90
MF717	120	30	7	43.50
MF720	120	60	8	45.50

# KLETON

## CREATE UNIQUE SOLUTIONS THAT ARE BUILT TO LAST.



Look for the "K" Custom symbol for customizable products



# LADDERS & SCAFFOLDING

## BASE PLATE, CASTER & STABILIZING JACK SCREW

Will level your scaffold on uneven terrain and provide secure footing. Choose between the following options:

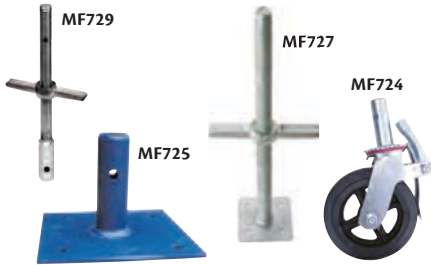

Model No.	Description	Wt. lbs.	Price /Each
MF724	8" Rubber Caster	12	60.90
MF725	Fixed Base Plate	3	13.90
MF726	Swivel Base Plate	4	22.50
MF727	Adjust. Jack Screw w/24" Base	12	58.50
MF728	Adjust. Jack Screw w/32" Base	15	89.50
MF729	Adjustable Jack Screw 24"	11	52.50

## WORK PLATFORMS

### ALUMINUM DECK

- Work platform installed with aluminum slip-resistant decking
- For both aluminum and steel scaffolds
- Side rails are made from "I" beam extrusions for added strength
- Dimpled and pierced aluminum decking assures a slip-resistant surface preventing material build-up
- Allows water to run off to help prevent ice build-up in freezing conditions
- 3-piece rung joints produce a tempered joint, making the work platform twist-proof
- For added safety they are fitted with easy-to-use windlocks
- Duty-rated: 75 lbs./sq. ft. (366 kg/m<sup>2</sup>)



Model No.	Length'	Width"	Weight lbs.	Price/Each
VC249	7	19	25	319.00
VC250	10	19	40	479.00

## LATERAL SIDE STABILIZER & WALL BRACKETS

Scaffolds should not be stacked higher than 3 times the width of the smallest base. To build a higher scaffold, lateral side stabilizers must be used. If the scaffold is situated near a wall, and its height is superior to three times the width of the base the scaffolding can be secured with wall brackets. Wall brackets are required every 15' in height and every 20' in width.

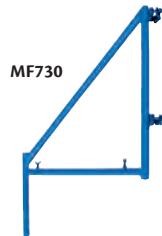

Model No.	Description	Wt. lbs.	Price /Each
MF730	Lateral Side Stabilizer	22	145.00
MF731	Wall Bracket	5	91.90
MF732	Screw for Wall Bracket	0.1	7.49

### PLYWOOD DECK

- Plywood-decked work platform; 5/8" thick plywood, hooks are offset to allow for next plank hook – no gap when set in continuous scaffolding
- For lightweight construction equipment
- Aluminum edge protects plywood from damage
- Side rails are made from "I" beam extrusions for added strength
- 3-piece rung joints produce a tempered joint, making the work platform twist-proof
- Fitted with easy-to-use windlocks
- 19" widths duty-rated: 75 lbs./sq. ft., 24" widths duty-rated: 50 lbs./sq. ft.



Model No.	Length'	Width"	Weight lbs.	Price/Each
MF754	7	19	30	289.00
MF755	7	24	34	315.00
MF756	10	19	48	439.00
MF757	10	24	56	455.00

## UNIVERSAL OUTRIGGERS WITH CASTERS SET

- Dimensions: 51.5" x 4" x 52.25" (130.81 x 101.6 x 132.72 cm)
- Weight: 104 lbs.
- Caster Size: 5"
- Caster Type: Double Locking Heavy Duty
- Includes: (4) Outriggers, (4) Casters, (8) Locking Pins
- Standard(s) Met: ANSI, CSA, OSHA



Model No.	Description	Wt. lbs.	Price /Each
MP929	Universal Outriggers with Casters Set	104	595.00

## ACCESSORIES

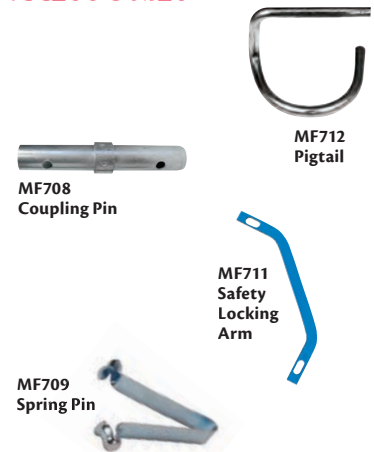

Model No.	Description	Wt. lbs.	Price /Each
MF708	Coupling w/1" Collet	0.8	7.59
MF709	Spring Pin	0.04	1.44
<b>LOCKING ASSEMBLIES</b>			
MF711	Safety Locking Arm	0.9	9.39
MF712	Pigtail	0.08	1.37

### GUARD POSTS & RAILS



Model No.	Description	Wt. lbs.	Price /Each
MF739	Guard Post for Guard Rail w/Support	11	67.90
MF740	Guard Rail 30"	1.5	18.90
MF742	Guard Rail 45"	2	18.90
MN530	Guard Rail 48"	2.5	16.90
MF743	Guard Rail 60"	3	18.50
MF744	Guard Rail 84"	4	22.50
MF745	Guard Rail 120"	6	40.50

## STEEL SCAFFOLDING

- Multi-level working area
- 1" O.D. 16-gauge steel frame
- Two anti-slip 14-gauge steel platforms
- Height: 4'
- Reach: 9'
- 4" heavy-duty double locking casters
- Units fold/collapse for easy storage
- Capacity: 500 lbs.
- Yellow powder coat finish
- Meets and exceeds CSA, OSHA & ANSI standards



VC781

VC782



Model No.	Overall Dimensions W" x L" x H"	Weight lbs.	Price /Each
VC782	22 1/2 x 41 x 45 3/4	50	249.00
VC781	22 1/2 x 49 1/2 x 57 3/4	59	269.00

\* More sizes & options available upon request



# LADDERS & SCAFFOLDING

## COMPLETE 18' DRYWALL BAKER SCAFFOLD TOWER SET

- Overall Height: 236"
- Overall Depth: 122"
- Width: 74"
- Weight: 629.6 lbs.
- Standard(s) Met: ANSI, CSA, OSHA
- Load Capacity: 851 lbs. (387 kg)  
Combined Weight of User & Material
- Working Heights: 2.25' - 16.9'
- Reach: 24"
- Caster Size: 5"
- Includes: (3) MetalTech 6' Baker Style Scaffold, (4) 46" Outriggers, (1) Guardrails System, (12) 5" Heavy-Duty Casters

**Model No. MP933**  
**Mfg. No. I-T3CISC**  
**Price/Each \$3105.00**



## COMPLETE 12' DRYWALL BAKER SCAFFOLD TOWER SET

- Overall Height: 183"
- Overall Depth: 58-1/2"
- Width: 74"
- Weight: 347.8 lbs.
- Load Capacity: 948 lbs. (431 kg)  
Combined Weight of User & Material
- Working Heights: 2.25' - 11.5'
- Reach: 17.5"
- Caster Size: 5"
- Standard(s) Met: ANSI, CSA, OSHA
- Includes: (2) MetalTech 6' Baker Style Scaffold, (4) Outriggers, (1) Guardrails System, (8) 5" Heavy-Duty Casters

**Model No. MP934**  
**Mfg. No. I-TCISC**  
**Price/Each \$1619.00**



## JOBSITE SERIES GUARDRAIL SCAFFOLD KIT

- Overall Height: 44-1/2"
- Overall Depth: 29-1/4"
- Width: 69.75"
- Weight: 55.4 lbs.
- Standard(s) Met: ANSI, CSA, OSHA
- Includes: (2) Guardrails with Gates, (4) Toggle Pins

**Model No. MP931**  
**Mfg. No. I-CISGRJP**  
**Price/Each \$419.00**



## COMPLETE MOTORIZED BUILDMAN™ 6' BAKER SCAFFOLD KIT

- The Climb-N-Go was designed to increase worker efficiency, eliminating the need to get off the scaffold to move it
- Equipped with a powerful electric motor, it is propelled by the energy of an 18 to 21 volt battery from any one of the six largest brands in the industry
- Its wheels are installed on the bottom of the scaffolding and the joystick control on the guardrail or directly on a rung
- Compatible with all Metaltech Baker types scaffolding
- Can be powered by: DEWALT®, MAKITA®, MILWAUKEE®, STANLEY® (18V), PORTER CABLE®, BLACK & DECKER®
- Features 4500 feet of battery life on a single battery charge
- Automatic wheel lock safety system
- Moves on a job site without the need for a freight elevator, unlike a scissor lift
- 76" W x 31" D x 118-3/4" H
- Weight: 274.26 lbs.
- Standard(s) Met: CSA S269.2-16, OSHA standards 1926.452(W)
- Includes: (1) Buildman™ 6' Drywall Baker (I-BMSS), (1) Guardrails System (I-BMSGRP), (1) Climb-N-Go (I-CNG)
- Hauling Capacity: 500 lbs. (226.8 kg)

**Model No. MP932**  
**Mfg. No. I-CNGBMK**  
**Price/Each \$3479.00**



## PORTABLE ALU SERIES™ SCAFFOLD

- Frame Material: Aluminum
- Overall Height: 72"
- Overall Depth: 29"
- Width: 56.5"
- Weight: 60 lbs.
- Load Capacity: 700 lbs. (318 kg) Combined Weight of User & Material
- Working Heights: 11.75", 23.5", 35.25", 47", 59", 70.75" (30, 60, 90, 119, 150, 180 cm)
- Reach: 12"
- Outside Diameter: 1.5"
- Caster Size: 5"
- Standard(s) Met: ANSI, CSA, OSHA

**Model No. MP930**  
**Mfg. No. I-CAIRC**  
**Price/Each \$835.00**



## BUILDMAN™ PORTABLE SCAFFOLD

- Convenient fold-away tool shelf
- Safety rail to hold onto for stability
- Folds flat for compact storage and transport
- Load Capacity: 750 lbs. (340 kg) Combined Weight of User & Material, 450 lbs. (204 kg) per Platform
- Overall Height: 4'
- Overall Depth: 40-5/8"
- Assembled Dimensions: 50-1/2" x 23-3/4" x 61-1/2" (128.3 x 60.3 x 156.2 cm)
- Weight: 69 lbs.
- Working Heights: 10" - 21-1/2" - 33" (25.4 cm - 54.61 cm - 83.82 cm)
- Platforms: 2 Platforms of 40-5/8" x 8-3/4" x 1-3/4" (103.2 x 22.2 x 4.4 cm)

**Model No. MP908**  
**Mfg. No. I-BM4S**  
**Price/Each \$355.00**



## BUILDMAN™ BAKER DRYWALL SCAFFOLD

- Safeclimb trapdoor and anti-slip deck
- Each end can be adjusted separately to be used on uneven surfaces and stairways
- Safeclimb rung step
- Quick and easy height adjustment
- Overall Height: 6'
- Overall Depth: 31"
- Assembled Dimensions: 75-3/4" x 31" x 76" (192.4 x 78.7 x 193 cm)
- Weight: 165 lbs. (74.8 kg)
- Working Heights: Adjustable from 29" to 71-1/2" (73.7 to 181.6 cm) in 2" (5 cm) increments

**Model No. MP909**  
**Mfg. No. I-BMSS**  
**Price/Each \$849.00**



## SMARTSTAIRS™ MODULAR CONSTRUCTION STAIR SYSTEM

- Solid, non-slip, stable and equipped with robust railings
- Telescopic and modular, Smartstairs™ adapt easily to all types of sites for both indoor and outdoor use
- Revolutionary system to avoid recurring expenses of single-use stairs and their limited lifespan
- The aluminum structure is thick, light, easy to maintain and does not rust
- Easy and quick installation, in less than 30 minutes (no tools are required)
- Ideal for use in industrial, commercial, and residential construction sites
- Material: Aluminium
- Standard(s) Met: OSHA, COHSR



Model No.	Mfg. No.	Steps	Platform Height"	Min. Platform Height"	Weight lbs.	Price /Each
MP920	AL-SSEH10	6-10	75	45	222.5	6498.00
MP921	AL-SSEH16	11-16	120	82-1/2	344.3	9795.00
MP922	AL-SSEH21	17-21	157-1/2	127-1/2	443.2	12843.00



## BUILD YOUR OWN CABINET WORKBENCH

- Versatile cabinet workbench suited for any industrial application that requires work surface and secure tool and parts storage
- Steel-wood fill tops available in grey or blue
- Capacity: 1000 lbs. evenly distributed
- Durable Kleton blue enamel finish
- Shipped knocked down



### A - CABINET SHELLS ONLY

- Made of heavy gauge all-welded 14-gauge steel



### C - SHELVES

- Made of 14-gauge steel
- Maximum two per cabinet
- Capacity: 300 lbs. evenly distributed







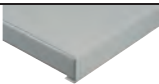

Model No.	Dimensions				Wt. lbs.	Price /Each	
	L"	x	W"	x			H"
FH165	28	x	59	x	32	105	819.00

Model No.	Dimensions			Wt. lbs.	Price /Each
	L"	x	W"		
FH164	27 3/4	x	58 3/4	15	275.00

### B - TOPS

- Our complete list of tops can be found on page 129

	Model No.		Size"	Price /Each
	Grey Tops	Blue Tops		
<b>STEEL - WOOD FILL</b>				
	FD033	FH183	30 x 60	385.00
	FD034	FH184	30 x 72	425.00
	FD035	FH185	36 x 60	425.00
	FD036	FH186	36 x 72	485.00
<b>LAMINATED WOOD - BULLNOSE EDGE</b>				
	FI528	-	30 x 60	412.00
	FI529	-	30 x 72	496.00
	FI532	-	36 x 60	496.00
	FI533	-	36 x 72	595.00
<b>LAMINATED WOOD - SQUARE EDGE</b>				
	FI733	-	30 x 60	399.00
	FI734	-	30 x 72	479.00
	FL597	-	36 x 60	480.00
	FI738	-	36 x 72	588.00
<b>SHOP TOPS</b>				
	FD004	-	30 x 60	535.00
	FD005	-	30 x 72	635.00
	FD006	-	36 x 60	645.00
	FD007	-	36 x 72	809.00
<b>PLASTIC LAMINATE</b>				
	FD011	-	30 x 60	575.00
	FD012	-	30 x 72	639.00
	FD013	-	36 x 60	645.00
	FD014	-	36 x 72	745.00
<b>STAINLESS STEEL</b>				
	FI271	-	30 x 60	1199.00
	FI272	-	30 x 72	1305.00
	FI276	-	36 x 60	1279.00
	FI277	-	36 x 72	1415.00

### D - DOOR

- Made of 18-gauge steel on rollers
- Recessed handles
- Includes: Plunger lock and two keys



Model No.	Description	Wt. lbs.	Price /Each
FH163	Door Set, Lock Included	40	629.00

### E - DRAWERS

- All-welded heavy gauge steel
- 100% full extension with ball bearing slide mechanism
- All locks keyed alike by drawer model
- Includes: locks and two keys
- Aluminum extrusion handles with grey end caps
- Capacity: 100 lbs. per drawer evenly distributed



Model No.	Dimensions				Wt. lbs.	Price /Each	
	L"	x	W"	x			H"
FH938	15 3/8	x	20	x	5 5/8	30	310.00
FH939	15 3/8	x	20	x	2 3/4	35	393.00

# WORKBENCHES

## CREATE A WORKBENCH DESIGNED FOR YOUR APPLICATION

- Select from the components below to build the workbench to fit your needs
- All components **required** to make up your workbench are on this page
- **Optional** features for enhanced functionality are on the following page
- All steel components are constructed of 14-gauge steel unless otherwise specified
- All mounting hardware included
- Capacities range from 1000 lbs. to 2500 lbs. evenly distributed
- All steel components are powder coated Kleton grey
- Shipped knocked down

### THINGS TO CONSIDER WHEN ORDERING A WORKBENCH

1. Determine the size (length, width, height) of the workbench required
2. Select one of each of the required components listed on this page, respecting the determined size of the workbench



### A - LEGS

- Legs static or mobile
- Comes with knockout for standard two-outlet electrical plug
- Provides an overall height of 34" w/top



### B - TOPS

A variety of tops are available: 14-gauge steel wood filled, laminated wood, shop top and plastic laminate in a variety of sizes.

Our complete list of tops can be found on page 129



Wood Top - Square Edge



Wood Top - Bullnose

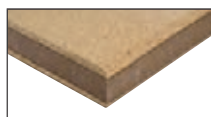

Shop Top



Plastic Laminate

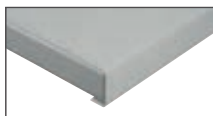

Steel Wood-Filled



Stainless Steel Wood-Filled

### C - UNIVERSAL STRINGERS

- Adds stability to the workbench
- Prevents legs from shifting
- Weight: 111 lbs.

### HEAVY-DUTY

Model No. FF979 For 48", 60" or 72" bench Price/Each \$92.50

Model No. FH925 For 84" bench Price/Each \$139.00

Model No. FH926 For 96" bench Price/Each \$159.00

### INDUSTRIAL DUTY

Model No. MO936 For 48", 60" or 72" bench Price/Each \$71.55



Model No.	Description	Dimensions D" x H"	Wt. lbs.	Price /Each
<b>HEAVY-DUTY</b>				
ML264	Single leg for use w/ 24"D top	22 x 32	14	141.00
ML265	Single leg for use w/ 30"D or 36"D top	28 x 32	15	149.00
ML266*	Pair of legs to use w/24"D tops, includes stringer FF979	22 x 32	38	279.00
ML268*	Pair of legs to use w/30"D or 36"D tops, includes stringer FF979	28 x 32	40	279.00
ML267*	Mobile kit for use w/24"D top (pair), includes stringer FF979	22 x 32	45	555.00
ML269*	Mobile kit for use w/30"D or 36"D top (pair), includes stringer FF979	28 x 32	40	529.00
FG732	Leg extensions to make height adjustable from 34"-39" in 1" increments (set of 4)		8	185.00
<b>INDUSTRIAL DUTY</b>				
M0931	Single leg for use w/24"D top	24 x 34	8	79.30
M0932	Single leg for use w/30"D or 36"D top	30 x 34	8	86.35

\* For 84" L and 96" L tops, FH925 or FH926 stringers are required



## CUSTOMIZE YOUR WORKBENCH WITH ANY OF THE FOLLOWING OPTIONS:



### D - DRAWERS

- Add storage to any workbench
- All-welded heavy-gauge steel
- 100% full extension with ball bearing slide mechanism
- Equipped with locks and two keys
- All locks keyed alike by drawer model
- Custom key options available
- Capacity: 100 lbs. per drawer evenly distributed
- Aluminum extrusion handles with grey end caps
- Overall Dimensions: 18" W x 21" D x 9" H



### SINGLE DRAWER UNITS

- (1) 15 3/8" W x 20" D x 5 5/8" H
- Model No. FH673**  
**Price/Each \$299.00**

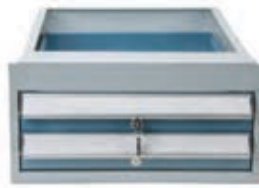

### DOUBLE DRAWER UNITS

- (2) 15 3/8" W x 20" D x 2 3/4" H
- Model No. FH674**  
**Price/Each \$380.00**

### E - BENCH RISER SHELVES

- Increase storage space
- Ideal for getting tools and other equipment off work surfaces
- 9" D x 12" H
- One per workbench



Model No.	Overall Width"	Wt. lbs.	Price/Each
FF956	48	19	199.00
FF957	60	24	195.00
FF958	72	29	209.00
FI319	84	35	319.00
FI320	96	42	415.00

### F - LOWER SHELVES

- Add extra storage to any workbench



Model No.	Overall Width"	Wt. lbs.	Price/Each
<b>HEAVY-DUTY One or two 9" deep shelves can be used per workbench</b>			
FF934	44 (For Use with 48" Top)	14	109.00
FF935	56 (For Use with 60" Top)	16	119.00
FF936	68 (For Use with 72" Top)	18	119.00
RL866	80 (For Use with 84" Top)	21	159.00
RL867	92 (For Use with 96" Top)	24	185.00
<b>INDUSTRIAL DUTY One 14-3/4" deep shelf can be used per workbench</b>			
MO933	48 (For Use with 48" Top)	12	85.50
MO934	60 (For Use with 60" Top)	15	105.00
MO935	72 (For Use with 72" Top)	18	120.00

### G - BACK STOPS

- Add a 3" edge to the back of any workbench
- One per bench top



Model No.	Overall Width"	Wt. lbs.	Price/Each
FF704	48	8	87.50
FF705	60	10	99.00
FF708	72	12	125.00
FI317	84	14	165.00
FI318	96	16	179.00

### H - END STOPS

- Add 3" sides to any workbench
- One per side desired to enclose



Model No.	Overall Width"	Wt. lbs.	Price/Each
FF792	24	4	54.90
FF793	30	5	55.90
FF794	36	6	69.90



We try to make it easy... Take a look at our pre-designed layout options on pages 130-134

Customize to your specifications. If you need specific sizes or requirements not available on this page, call us today with your specs!

# WORKBENCHES

Customize your own workbench... simply select any two cabinets listed and add a top.

## WORKBENCH PEDESTALS

- All-welded heavy-gauge steel
- 100% full extension drawers with ball bearing slide mechanism
- Capacity: 100 lbs. per drawer evenly distributed
- Reversible doors, can be opened on either left or right side
- Optional bases add height in 4" increments (maximum two bases per pedestal)
- Aluminum extrusion handles with grey end caps
- Complete with locks and two keys
- All locks keyed alike for pedestal model
- Custom key options available
- 18" W x 21" D x 28" H, overall cabinet size
- 30" overall height with top
- Powder coat finish with grey shell and Kleton blue on doors and drawers



### FULL DOOR

- 16 3/4" W x 21" D x 24" H
  - Internal adjustable shelf included
  - Weight: 48 lbs.
- Model No. FH666**  
**Price/Each \$375.00**



### TWO DOORS

- (2) 16 3/4" W x 21" D x 12" H
  - Weight: 48 lbs.
- Model No. FH667**  
**Price/Each \$445.00**



### TWO DRAWERS & ONE DOOR

- (2) 15 3/8" W x 20" D x 5 5/8" H
  - (1) 16 3/4" W x 21" D x 12" H
  - Weight: 59 lbs.
- Model No. FH668**  
**Price/Each \$615.00**



### TWO DRAWERS

- (2) 15 3/8" W x 20" D x 11 5/8" H
  - Weight: 66 lbs.
- Model No. F1166**  
**Price/Each \$649.00**



### THREE DRAWERS

- (2) 15 3/8" W x 20" D x 5 5/8" H
  - (1) 15 3/8" W x 20" D x 11 5/8" H
  - Weight: 78 lbs.
- Model No. F1167**  
**Price/Each \$749.00**



### FOUR DRAWERS

- (4) 15 3/8" W x 20" D x 5 5/8" H
  - Weight: 68 lbs.
- Model No. FH669**  
**Price/Each \$749.00**



### FOUR DRAWERS & ONE DOOR

- (4) 15 3/8" W x 20" D x 2 5/8" H
  - (1) 16 3/4" W x 21" D x 12" H
  - Weight: 63 lbs.
- Model No. FH670**  
**Price/Each \$815.00**



### SIX DRAWERS

- (4) 15 3/8" W x 20" D x 2 5/8" H
  - (2) 15 3/8" W x 20" D x 5 5/8" H
  - Weight: 94 lbs.
- Model No. FH671**  
**Price/Each \$995.00**



### BASE

- (1) 4" high - 34" high with top
  - Weight: 5 lbs.
- Model No. FH672**  
**Price/Each \$94.95**



## LEG & PEDESTAL COMBINATIONS

- All-welded 14-gauge steel legs
- Knockout for standard two-outlet electrical plug
- Overall height of 34" with top
- Powder coat Kleton grey finish

Model No.	Description	Dimensions			Wt. lbs.	Price /Each
		D"	x	H"		
ML264	Single leg for use w/ 24" D top	22	x	32	14	141.00
ML265	Single leg for use w/ 30" D or 36" D top	28	x	32	15	149.00
FH672	Pedestal Base (Max 1)	-	x	4	5	94.95
FF920	Bench Leg Gussets (Pkg. of 2)	-	x	-	3	73.50

Pedestal base and bench leg gussets are required components when building all leg/pedestal combinations



We try to make it easy...  
Take a look at our pre-designed layout options on pages 130-134

### HOW TO ORDER

1. Choose the pedestal desired
2. Determine the depth of the workbench
3. Add the appropriate leg configuration

See our selection of workbench tops on page 129.

## WORKBENCH TOPS

SELECT ONE OF THESE SIX TOPS TO CUSTOMIZE YOUR WORKBENCH



### LAMINATED HARDWOOD TOPS SQUARE EDGE

- Lacquer finished tops for durability
- Heavy-duty solid hardwood laminations for long life
- Overall Thickness: 1 3/4"
- 1/8" edge radius



Model No.	Size D" x W"	Wt. lbs.	Price /Each
FI730	24 x 48	48	256.00
FL592	24 x 60	64	320.00
FL593	24 x 72	76	384.00
FI731	24 x 84	85	452.00
FL594	24 x 96	90	512.00
FI732	24 x 120	125	690.00
FL595	30 x 48	60	320.00
FI733	30 x 60	75	399.00
FI734	30 x 72	85	479.00
FI735	30 x 84	101	562.00
FI736	30 x 96	119	642.00
FI737	30 x 120	191	799.00
FL596	36 x 48	72	384.00
FL597	36 x 60	92	480.00
FI738	36 x 72	107	588.00
FL598	36 x 84	124	674.00
FI739	36 x 96	144	769.00
FL599	36 x 120	154	963.00
FI740	48 x 48	99	599.00
FL600	48 x 60	120	740.00
FL601	48 x 72	138	880.00
FL602	48 x 84	163	1050.00
FL603	48 x 96	183	1125.00
FL604	48 x 120	240	1280.00

Note: Tops over 36" D are shipped in two pieces of hardwood, hardware is included.

### LAMINATED HARDWOOD TOPS BULLNOSE EDGE

- Lacquer finished tops for durability
- Heavy-duty solid hardwood laminations for long life
- Overall Thickness: 1 3/4"
- 1/8" edge radius



Model No.	Size D" x W"	Wt. lbs.	Price /Each
FI522	24 x 48	47	279.00
FI523	24 x 60	58	330.00
FI524	24 x 72	69	396.00
FL605	24 x 84	81	474.00
FI525	24 x 96	92	528.00
FI526	24 x 120	117	713.00
FI527	30 x 48	60	336.00
FI528	30 x 60	73	412.00
FI529	30 x 72	90	496.00
FI530	30 x 84	100	579.00
FI531	30 x 96	120	660.00
FL606	30 x 120	150	826.00
FL607	36 x 48	71	396.00
FI532	36 x 60	110	496.00
FI533	36 x 72	118	595.00
FL608	36 x 84	125	694.00
FI534	36 x 96	144	799.00
FL609	36 x 120	177	992.00
FL610	48 x 48	94	625.00
FL611	48 x 60	119	762.00
FL612	48 x 72	139	914.00
FL613	48 x 84	164	1142.00
FL614	48 x 96	185	1192.00
FL615	48 x 120	243	1320.00

Note: Tops over 36" D are shipped in two pieces of hardwood, hardware is included.

### LAMINATED HARDWOOD TOPS

- Lacquer finished tops for durability
- Industrial-duty solid hardwood laminations for long life
- Overall Thickness: 1 1/4"
- 1/8" radius edge



Model No.	Size D" x W"	Wt. lbs.	Price /Each
<b>BULL NOSE EDGE</b>			
FM930	24 x 48	35	210.00
FM931	24 x 60	44	250.00
FM932	24 x 72	54	299.00
FM933	30 x 48	43	250.00
FM934	30 x 60	55	312.00
FM935	30 x 72	67	379.00
FN369	36 x 60	70	411.00
FM936	36 x 72	77	444.00
<b>SQUARE EDGE</b>			
FM937	24 x 48	35	194.00
FM938	24 x 60	41	246.00
FM939	24 x 72	54	290.00
FM940	30 x 48	45	246.00
FM941	30 x 60	55	299.00
FM942	30 x 72	67	365.00
FN370	36 x 60	65	399.00
FM943	36 x 72	80	433.00

### STEEL WOOD-FILLED TOPS

- Heavy-duty 14-gauge steel with formed edges
- Reinforced with wood core for sound reduction and added strength
- Overall Thickness: 1 3/4"
- Colour: Powder coat Kleton grey

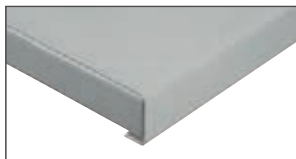

Model No.	Size D" x W"	Wt. lbs.	Price /Each
FD030	24 x 48	59	369.00
FD031	24 x 60	74	375.00
FH871	30 x 48	70	465.00
FD033	30 x 60	101	385.00
FD034	30 x 72	110	425.00
FH872	30 x 84	118	625.00
FH873	30 x 96	140	675.00
FH874	36 x 48	88	525.00
FD035	36 x 60	111	425.00
FD036	36 x 72	119	485.00
FH875	36 x 84	148	775.00
FH876	36 x 96	174	739.00

### 304 STAINLESS STEEL WOOD-FILLED TOPS

- Heavy-duty 14-gauge stainless steel with a number 4 finish and formed edges
- Reinforced with wood core for sound reduction and added strength
- Overall Thickness: 1 3/4"

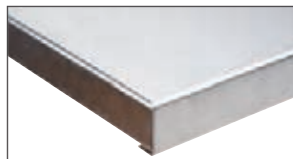

Model No.	Size D" x W"	Wt. lbs.	Price /Each
FI268*	24 x 48	64	949.00
FI269*	24 x 60	70	1035.00
FI270*	30 x 48	72	1105.00
FI271*	30 x 60	92	1199.00
FI272*	30 x 72	112	1305.00
FI273*	30 x 84	129	1589.00
FI274*	30 x 96	143	1725.00
FI275*	36 x 48	87	1185.00
FI276*	36 x 60	110	1279.00
FI277*	36 x 72	132	1415.00
FI278*	36 x 84	154	1725.00
FI279*	36 x 96	169	1839.00

\* Stainless Steel finish may vary



**CANADA'S LEADING MATERIAL HANDLING SUPPLIER**



# WORKBENCHES

## INDUSTRIAL-DUTY - 1000-LB. CAPACITY, ADJUSTABLE LEGS

FN064 - Plastic Laminate



Model No.	Size D" x W"	Price /Each
<b>STEEL - WOOD FILL</b>		
FN049	24 x 60	505.00
FN052	36 x 60	563.00
FN053	36 x 72	594.00
<b>LAMINATED WOOD - 1 3/4"</b>		
FN054	24 x 60	445.00
FN055	30 x 60	513.00
FN056	30 x 72	585.00
FN057	36 x 60	585.00
FN058	36 x 72	665.00

Model No.	Size D" x W"	Price /Each
<b>SHOP TOP</b>		
FN059	24 x 60	685.00
FN060	30 x 60	812.00
FN061	30 x 72	913.00
FN062	36 x 60	926.00
FN063	36 x 72	1114.00
<b>PLASTIC LAMINATE</b>		
FN064	24 x 60	765.00
FN065	30 x 60	838.00
FN066	30 x 72	913.00
FN067	36 x 60	920.00
FN068	36 x 72	1073.00

Model No.	Size D" x W"	Price /Each
<b>LAMINATED WOOD - 1 1/4"</b>		
FN269	24 x 60	382.00
FN270	30 x 60	439.00
FN271	30 x 72	503.00
FN272	36 x 60	503.00
FN273	36 x 72	572.00

KLETON

## INDUSTRIAL-DUTY - 1000-LB. CAPACITY, ADJUSTABLE LEGS

FN089 - Steel Wood Fill



Model No.	Size D" x W"	Price /Each
<b>STEEL - WOOD FILL</b>		
FN089	24 x 60	873.00
FN092	36 x 60	918.00
FN093	36 x 72	951.00
<b>LAMINATED WOOD - 1 3/4"</b>		
FN094	24 x 60	734.00
FN095	30 x 60	803.00
FN096	30 x 72	867.00
FN097	36 x 60	867.00
FN098	36 x 72	947.00

Model No.	Size D" x W"	Price /Each
<b>SHOP TOP</b>		
FN099	24 x 60	1005.00
FN100	30 x 60	1082.00
FN101	30 x 72	1216.00
FN102	36 x 60	1216.00
FN103	36 x 72	1417.00
<b>PLASTIC LAMINATE</b>		
FN104	24 x 60	1109.00
FN105	30 x 60	1169.00
FN106	30 x 72	1219.00
FN107	36 x 60	1219.00
FN108	36 x 72	1342.00

Model No.	Size D" x W"	Price /Each
<b>LAMINATED WOOD - 1 1/4"</b>		
FN279	34 x 60	659.00
FN280	34 x 60	722.00
FN281	34 x 72	780.00
FN282	36 x 60	780.00
FN283	36 x 72	854.00

KLETON

## INDUSTRIAL-DUTY - 1000-LB. CAPACITY, ADJUSTABLE LEGS

FN274 - Laminated Wood



Model No.	Size D" x W"	Price /Each
<b>STEEL - WOOD FILL</b>		
FN069	24 x 60	676.00
FN072	36 x 60	723.00
FN073	36 x 72	755.00
<b>LAMINATED WOOD - 1 3/4"</b>		
FN074	24 x 60	572.00
FN075	30 x 60	636.00
FN076	30 x 72	705.00
FN077	36 x 60	705.00
FN078	36 x 72	784.00

Model No.	Size D" x W"	Price /Each
<b>SHOP TOP</b>		
FN079	24 x 60	755.00
FN080	30 x 60	868.00
FN081	30 x 72	1014.00
FN082	36 x 60	1014.00
FN083	36 x 72	1198.00
<b>PLASTIC LAMINATE</b>		
FN084	24 x 60	828.00
FN085	30 x 60	906.00
FN086	30 x 72	1008.00
FN087	36 x 60	1008.00
FN088	36 x 72	1104.00

Model No.	Size D" x W"	Price /Each
<b>LAMINATED WOOD - 1 1/4"</b>		
FN274	60 x 34	514.00
FN275	60 x 34	572.00
FN276	30 x 72	636.00
FN277	36 x 60	636.00
FN278	36 x 72	705.00

KLETON

## HEAVY-DUTY - 2500-LB. CAPACITY

FF658 Laminated Wood



Model No.	Size D" x W"	Price /Each
<b>STEEL - WOOD FILL</b>		
FF667	24 x 60	552.00
FF669	30 x 60	560.00
FF670	30 x 72	597.00
FF671	36 x 60	597.00
FF672	36 x 72	630.00
<b>LAMINATED WOOD - 1 3/4"</b>		
FF653	24 x 60	503.00
FF655	30 x 60	576.00
FF656	30 x 72	659.00
FF657	36 x 60	659.00
FF658	36 x 72	751.00

Model No.	Size D" x W"	Price /Each
<b>SHOP TOP</b>		
FH878	24 x 60	773.00
FF676	30 x 60	872.00
FF677	30 x 72	997.00
FH877	36 x 60	997.00
FF679	36 x 72	1176.00
<b>PLASTIC LAMINATE</b>		
FH880	24 x 60	833.00
FF662	30 x 60	952.00
FF663	30 x 72	1075.00
FH879	36 x 60	1033.00
FF665	36 x 72	1241.00
<b>LAMINATED WOOD - 1 1/4"</b>		
FM948*	24 x 60	462.00
FM949*	30 x 60	537.00
FM950*	30 x 72	613.00
FM951*	36 x 60	613.00
FM952*	36 x 72	688.00

\*1500-lb. capacity

KLETON

## HEAVY-DUTY - 2500-LB. CAPACITY

FG296 - Shop Top



Model No.	Size D" x W"	Price /Each
<b>STEEL - WOOD FILL</b>		
FG289	24 x 60	942.00
FG290	30 x 60	954.00
FG291	30 x 72	996.00
FG292	36 x 60	996.00
FG293	36 x 72	1029.00
<b>LAMINATED WOOD - 1 3/4"</b>		
FG281	24 x 60	899.00
FG282	30 x 60	984.00
FG283	30 x 72	1068.00
FG284	36 x 60	1068.00
FG285	36 x 72	1165.00

Model No.	Size D" x W"	Price /Each
<b>SHOP TOP</b>		
FH886	24 x 60	1189.00
FG294	30 x 60	1391.00
FG295	30 x 72	1503.00
FH885	36 x 60	1394.00
FG296	36 x 72	1691.00
<b>PLASTIC LAMINATE</b>		
FH888	24 x 60	1240.00
FG286	30 x 60	1382.00
FG287	30 x 72	1450.00
FH887	36 x 60	1478.00
FG288	36 x 72	1584.00
<b>LAMINATED WOOD - 1 1/4"</b>		
FM958*	24 x 60	834.00
FM959*	30 x 60	912.00
FM960*	30 x 72	953.00
FM961*	36 x 60	953.00
FM962*	36 x 72	1034.00

\*1500-lb. capacity

KLETON

## HEAVY-DUTY - 2500-LB. CAPACITY

FF695 - Plastic Laminate



Model No.	Size D" x W"	Price /Each
<b>STEEL - WOOD FILL</b>		
FF700	24 x 60	734.00
FF702	30 x 60	746.00
FF703	30 x 72	789.00
FF706	36 x 60	789.00
FF707	36 x 72	818.00
<b>LAMINATED WOOD - 1 3/4"</b>		
FF686	24 x 60	670.00
FF688	30 x 60	749.00
FF689	30 x 72	832.00
FF690	36 x 60	832.00
FF691	36 x 72	922.00

Model No.	Size D" x W"	Price /Each
<b>SHOP TOP</b>		
FH882	24 x 60	1020.00
FF712	30 x 60	1096.00
FF713	30 x 72	1211.00
FH881	36 x 60	1187.00
FF715	36 x 72	1383.00
<b>PLASTIC LAMINATE</b>		
FH884	24 x 60	1074.00
FF695	30 x 60	1148.00
FF696	30 x 72	1252.00
FH883	36 x 60	1257.00
FF698	36 x 72	1418.00
<b>LAMINATED WOOD - 1 1/4"</b>		
FM953*	24 x 60	624.00
FM954*	30 x 60	693.00
FM955*	30 x 72	774.00
FM956*	36 x 60	774.00
FM957*	36 x 72	855.00

\*1500-lb. capacity

KLETON



IF YOU NEED SPECIFIC SIZES OR REQUIREMENTS NOT AVAILABLE ON THESE PAGES, SEE PAGES 126-129 OR CALL US TODAY WITH YOUR SPECS!

# WORKBENCHES

## INDUSTRIAL-DUTY - 1000-LB. CAPACITY, ADJUSTABLE LEGS

FN119 – Shop Top



Model No.	Size D" x W"	Price /Each
<b>STEEL - WOOD FILL</b>		
FN109	24 x 60	983.00
FN112	36 x 60	1031.00
FN113	36 x 72	1062.00
<b>LAMINATED WOOD - 1 3/4"</b>		
FN114	24 x 60	913.00
FN115	30 x 60	989.00
FN116	30 x 72	1058.00
FN117	36 x 60	1058.00
FN118	36 x 72	1128.00

Model No.	Size D" x W"	Price /Each
<b>SHOP TOP</b>		
FN119	24 x 60	1200.00
FN120	30 x 60	1282.00
FN121	30 x 72	1394.00
FN122	36 x 60	1394.00
FN123	36 x 72	1585.00

Model No.	Size D" x W"	Price /Each
<b>PLASTIC LAMINATE</b>		
FN124	24 x 60	1244.00
FN125	30 x 60	1364.00
FN126	30 x 72	1456.00
FN127	36 x 60	1456.00
FN128	36 x 72	1536.00
<b>LAMINATED WOOD - 1 1/4"</b>		
FN284	24 x 60	854.00
FN285	30 x 60	933.00
FN286	30 x 72	991.00
FN287	36 x 60	991.00
FN288	36 x 72	1050.00



## INDUSTRIAL-DUTY - 1000-LB. CAPACITY, ADJUSTABLE LEGS

FN129 – Steel Wood Fill



Model No.	Size D" x W"	Price /Each
<b>STEEL - WOOD FILL</b>		
FN129	24 x 60	1126.00
FN132	36 x 60	1177.00
FN133	36 x 72	1208.00
<b>LAMINATED WOOD - 1 3/4"</b>		
FN134	24 x 60	1046.00
FN135	30 x 60	1128.00
FN136	30 x 72	1198.00
FN137	36 x 60	1198.00
FN138	36 x 72	1285.00



## INDUSTRIAL-DUTY - 1000-LB. CAPACITY, ADJUSTABLE LEGS

FN294 – Laminated Wood



Model No.	Size D" x W"	Price /Each
<b>STEEL - WOOD FILL</b>		
FN149	60 x 24	1338.00
FN152	60 x 36	1392.00
FN153	72 x 36	1420.00
<b>LAMINATED WOOD - 1 3/4"</b>		
FN154	60 x 24	1241.00
FN155	60 x 30	1324.00
FN156	72 x 30	1385.00
FN157	60 x 36	1385.00
FN158	72 x 36	1487.00



Model No.	Size D" x W"	Price /Each
<b>SHOP TOP</b>		
FN159	60 x 24	1484.00
FN160	60 x 30	1596.00
FN161	72 x 30	1721.00
FN162	60 x 36	1721.00
FN163	72 x 36	1903.00

Model No.	Size D" x W"	Price /Each
<b>PLASTIC LAMINATE</b>		
FN164	60 x 24	1676.00
FN165	60 x 30	1728.00
FN166	72 x 30	1813.00
FN167	60 x 36	1813.00
FN168	72 x 36	1869.00
<b>LAMINATED WOOD - 1 1/4"</b>		
FN294	24 x 60	1161.00
FN295	30 x 60	1240.00
FN296	30 x 72	1300.00
FN297	36 x 60	1300.00
FN298	36 x 72	1391.00

## HEAVY-DUTY - 2500-LB. CAPACITY

FG093 Laminated Wood



Model No.	Size D" x W"	Price /Each
<b>STEEL - WOOD FILL</b>		
FG104	24 x 60	1069.00
FG106	30 x 60	1084.00
FG107	30 x 72	1120.00
FG108	36 x 60	1120.00
FG109	36 x 72	1153.00
<b>LAMINATED WOOD - 1 3/4"</b>		
FG090	24 x 60	1027.00
FG092	30 x 60	1117.00
FG093	30 x 72	1196.00
FG094	36 x 60	1196.00
FG095	36 x 72	1268.00

Model No.	Size D" x W"	Price /Each
<b>SHOP TOP</b>		
FH890	24 x 60	1352.00
FG113	30 x 60	1450.00
FG114	30 x 72	1549.00
FH889	36 x 60	1549.00
FG116	36 x 72	1732.00

Model No.	Size D" x W"	Price /Each
<b>PLASTIC LAMINATE</b>		
FH892	24 x 60	1400.00
FG099	30 x 60	1484.00
FG100	30 x 72	1562.00
FH891	36 x 60	1562.00
FG102	36 x 72	1674.00
<b>LAMINATED WOOD - 1 1/4"</b>		
FM963*	24 x 60	954.00
FM964*	30 x 60	1038.00
FM965*	30 x 72	1111.00
FM966*	36 x 60	1111.00
FM967*	36 x 72	1178.00



\*1500-lb. capacity

## HEAVY-DUTY - 2500-LB. CAPACITY

FG280 – Shop Top



Model No.	Size D" x W"	Price /Each
<b>STEEL - WOOD FILL</b>		
FG273	24 x 60	1223.00
FG274	30 x 60	1246.00
FG275	30 x 72	1279.00
FG276	36 x 60	1279.00
FG277	36 x 72	1310.00
<b>LAMINATED WOOD - 1 3/4"</b>		
FG265	24 x 60	1182.00
FG266	30 x 60	1268.00
FG267	30 x 72	1352.00
FG268	36 x 60	1352.00
FG269	36 x 72	1448.00



Model No.	Size D" x W"	Price /Each
<b>SHOP TOP</b>		
FH894	24 x 60	1431.00
FG278	30 x 60	1613.00
FG279	30 x 72	1707.00
FH893	36 x 60	1709.00
FG280	36 x 72	1842.00
<b>PLASTIC LAMINATE</b>		
FH896	24 x 60	1506.00
FG270	30 x 60	1624.00
FG271	30 x 72	1708.00
FH895	36 x 60	1708.00
FG272	36 x 72	1820.00
<b>LAMINATED WOOD - 1 1/4"</b>		
FM968*	24 x 60	1099.00
FM969*	30 x 60	1178.00
FM970*	30 x 72	1256.00
FM971*	36 x 60	1256.00
FM972*	36 x 72	1347.00

\*1500-lb. capacity

## HEAVY-DUTY - 2500-LB. CAPACITY

FG648 – Plastic Laminate



Model No.	Size D" x W"	Price /Each
<b>STEEL - WOOD FILL</b>		
FG443	24 x 60	1395.00
FG444	30 x 60	1413.00
FG642	30 x 72	1448.00
FG641	36 x 60	1448.00
FG640	36 x 72	1479.00
<b>LAMINATED WOOD - 1 3/4"</b>		
FG639	24 x 60	1401.00
FG638	30 x 60	1492.00
FG637	30 x 72	1569.00
FG636	36 x 60	1569.00
FG635	36 x 72	1672.00



Model No.	Size D" x W"	Price /Each
<b>SHOP TOP</b>		
FH898	24 x 60	1628.00
FG647	30 x 60	1924.00
FG646	30 x 72	2033.00
FH897	36 x 60	1857.00
FG645	36 x 72	2129.00

Model No.	Size D" x W"	Price /Each
<b>PLASTIC LAMINATE</b>		
FH900	24 x 60	1786.00
FG650	30 x 60	1761.00
FG649	30 x 72	1854.00
FH899	36 x 60	1942.00
FG648	36 x 72	1978.00
<b>LAMINATED WOOD - 1 1/4"</b>		
FM973*	24 x 60	1298.00
FM974*	30 x 60	1389.00
FM975*	30 x 72	1462.00
FM976*	36 x 60	1462.00
FM977*	36 x 72	1558.00

\*1500-lb. capacity



IF YOU NEED SPECIFIC SIZES OR REQUIREMENTS NOT AVAILABLE ON THESE PAGES, SEE PAGES 126-129 OR CALL US TODAY WITH YOUR SPECS!

# WORKBENCHES



## INDUSTRIAL-DUTY - 1000-LB. CAPACITY, ADJUSTABLE LEGS

**FN178 - Laminated Wood**



Model No.	Size D" x W"	Price /Each
<b>STEEL - WOOD FILL</b>		
FN173	24 x 60	1021.00
FN170	36 x 60	1071.00
FN169	36 x 72	1104.00
<b>LAMINATED WOOD - 1 3/4"</b>		
FN178	24 x 60	1201.00
FN177	30 x 60	1109.00
FN176	30 x 72	1109.00
FN175	36 x 60	1030.00
FN174	36 x 72	945.00

Model No.	Size D" x W"	Price /Each
<b>SHOP TOP</b>		
FN183	24 x 60	1637.00
FN182	30 x 60	1428.00
FN181	30 x 72	1428.00
FN180	36 x 60	1306.00
FN179	36 x 72	1210.00

Model No.	Size D" x W"	Price /Each
<b>PLASTIC LAMINATE</b>		
FN188	24 x 60	1557.00
FN187	30 x 60	1443.00
FN186	30 x 72	1443.00
FN185	36 x 60	1372.00
FN184	36 x 72	1286.00
<b>LAMINATED WOOD - 1 1/4"</b>		
FN333	24 x 60	1083.00
FN332	30 x 60	998.00
FN331	30 x 72	998.00
FN330	36 x 60	933.00
FN329	36 x 72	880.00



## INDUSTRIAL-DUTY - 1000-LB. CAPACITY, ADJUSTABLE LEGS

**FN189 - Steel Wood Fill**



Model No.	Size D" x W"	Price /Each
<b>STEEL - WOOD FILL</b>		
FN193	60 x 24	1104.00
FN190	60 x 36	1156.00
FN189	72 x 36	1184.00
<b>LAMINATED WOOD - 1 3/4"</b>		
FN198	24 x 60	1024.00
FN197	30 x 60	1103.00
FN196	30 x 72	1180.00
FN195	36 x 60	1180.00
FN194	36 x 72	1271.00



## INDUSTRIAL-DUTY - 1000-LB. CAPACITY, ADJUSTABLE LEGS

**FN224 - Plastic Laminate**



Model No.	Size D" x W"	Price /Each
<b>STEEL - WOOD FILL</b>		
FN213	24 x 60	813.00
FN210	36 x 60	867.00
FN209	36 x 72	900.00
<b>LAMINATED WOOD - 1 3/4"</b>		
FN218	24 x 60	755.00
FN217	30 x 60	842.00
FN216	30 x 72	913.00
FN215	36 x 60	913.00
FN214	36 x 72	996.00

Model No.	Size D" x W"	Price /Each
<b>SHOP TOP</b>		
FN223	24 x 60	1002.00
FN222	30 x 60	1136.00
FN221	30 x 72	1189.00
FN220	36 x 60	1204.00
FN219	36 x 72	1411.00

Model No.	Size D" x W"	Price /Each
<b>PLASTIC LAMINATE</b>		
FN228	24 x 60	1047.00
FN227	30 x 60	1148.00
FN226	30 x 72	1204.00
FN225	36 x 60	1226.00
FN224	36 x 72	1322.00
<b>LAMINATED WOOD - 1 1/4"</b>		
FN343	24 x 60	652.00
FN342	30 x 60	725.00
FN341	30 x 72	785.00
FN340	36 x 60	785.00
FN339	36 x 72	864.00



## HEAVY-DUTY - 2500-LB. CAPACITY

**FI552 - Steel Wood Fill**



Model No.	Size D" x W"	Price /Each
<b>STEEL - WOOD FILL</b>		
FI556	24 x 60	1114.00
FI555	30 x 60	1129.00
FI554	30 x 72	1166.00
FI553	36 x 60	1166.00
FI552	36 x 72	1201.00
<b>LAMINATED WOOD - 1 3/4"</b>		
FI561	24 x 60	1027.00
FI560	30 x 60	1117.00
FI559	30 x 72	1202.00
FI558	36 x 60	1202.00
FI557	36 x 72	1298.00

Model No.	Size D" x W"	Price /Each
<b>SHOP TOP</b>		
FI566	24 x 60	1341.00
FI565	30 x 60	1441.00
FI564	30 x 72	1547.00
FI563	36 x 60	1547.00
FI562	36 x 72	1784.00

Model No.	Size D" x W"	Price /Each
<b>PLASTIC LAMINATE</b>		
FI571	24 x 60	1400.00
FI570	30 x 60	1512.00
FI569	30 x 72	1596.00
FI568	36 x 60	1596.00
FI567	36 x 72	1708.00
<b>LAMINATED WOOD - 1 1/4"</b>		
FN013*	24 x 60	954.00
FN012*	30 x 60	1038.00
FN011*	30 x 72	1117.00
FN010*	36 x 60	1117.00
FN009*	36 x 72	1202.00



\*1500-lb. capacity

## HEAVY-DUTY - 2500-LB. CAPACITY

**FI582 - Shop Top**



Model No.	Size D" x W"	Price /Each
<b>STEEL - WOOD FILL</b>		
FI576	24 x 60	1201.00
FI575	30 x 60	1221.00
FI574	30 x 72	1260.00
FI573	36 x 60	1260.00
FI572	36 x 72	1286.00
<b>LAMINATED WOOD - 1 3/4"</b>		
FI581	24 x 60	1111.00
FI580	30 x 60	1196.00
FI579	30 x 72	1280.00
FI578	36 x 60	1280.00
FI577	36 x 72	1377.00



\*1500-lb. capacity

## HEAVY-DUTY - 2500-LB. CAPACITY

**FI607 - Laminated Wood**



Model No.	Size D" x W"	Price /Each
<b>STEEL - WOOD FILL</b>		
FI596	24 x 60	881.00
FI595	30 x 60	907.00
FI594	30 x 72	943.00
FI593	36 x 60	943.00
FI592	36 x 72	977.00
<b>LAMINATED WOOD - 1 3/4"</b>		
FI601	24 x 60	858.00
FI600	30 x 60	948.00
FI599	30 x 72	1027.00
FI598	36 x 60	1027.00
FI597	36 x 72	1124.00

Model No.	Size D" x W"	Price /Each
<b>SHOP TOP</b>		
FI606	24 x 60	1113.00
FI605	30 x 60	1260.00
FI604	30 x 72	1374.00
FI603	36 x 60	1374.00
FI602	36 x 72	1537.00

Model No.	Size D" x W"	Price /Each
<b>PLASTIC LAMINATE</b>		
FI611	24 x 60	1176.00
FI610	30 x 60	1288.00
FI609	30 x 72	1372.00
FI608	36 x 60	1372.00
FI607	36 x 72	1456.00
<b>LAMINATED WOOD - 1 1/4"</b>		
FN023*	24 x 60	797.00
FN022*	30 x 60	882.00
FN021*	30 x 72	954.00
FN020*	36 x 60	954.00
FN019*	36 x 72	1044.00



\*1500-lb. capacity



IF YOU NEED SPECIFIC SIZES OR REQUIREMENTS NOT AVAILABLE ON THESE PAGES, SEE PAGES 126-129 OR CALL US TODAY WITH YOUR SPECS!



# WORKBENCHES

## INDUSTRIAL-DUTY - 1000-LB. CAPACITY, ADJUSTABLE LEGS

**FN234 - Laminated Wood**



Model No.	Size D" x W"	Price /Each
<b>STEEL - WOOD FILL</b>		
FN233	24 x 60	874.00
FN230	36 x 60	922.00
FN229	36 x 72	954.00
<b>LAMINATED WOOD - 1 3/4"</b>		
FN238	24 x 60	812.00
FN237	30 x 60	888.00
FN236	30 x 72	964.00
FN235	36 x 60	964.00
FN234	36 x 72	1046.00



## INDUSTRIAL-DUTY - 1000-LB. CAPACITY, ADJUSTABLE LEGS

**FN249 - Steel Wood Fill**



Model No.	Size D" x W"	Price /Each
<b>STEEL - WOOD FILL</b>		
FN253	24 x 60	1226.00
FN257	30 x 60	1221.00
FN256	30 x 72	1293.00
FN250	36 x 60	1274.00
FN249	36 x 72	1304.00

Model No.	Size D" x W"	Price /Each
<b>LAMINATED WOOD - 1 3/4"</b>		
FN258	24 x 60	1140.00
FN257	30 x 60	1221.00
FN256	30 x 72	1293.00
FN255	36 x 60	1293.00
FN254	36 x 72	1385.00



## HEAVY-DUTY - 2500-LB. CAPACITY

**FI667 - Plastic Laminate**



Model No.	Size D" x W"	Price /Each
<b>STEEL - WOOD FILL</b>		
FI656	24 x 60	1486.00
FI655	30 x 60	1498.00
FI654	30 x 72	1531.00
FI653	36 x 60	1531.00
FI652	36 x 72	1562.00

Model No.	Size D" x W"	Price /Each
<b>LAMINATED WOOD - 1 3/4"</b>		
FI661	24 x 60	1431.00
FI660	30 x 60	1510.00
FI659	30 x 72	1594.00
FI658	36 x 60	1594.00
FI657	36 x 72	1689.00



Model No.	Size D" x W"	Price /Each
<b>SHOP TOP</b>		
FI666	24 x 60	1717.00
FI665	30 x 60	1828.00
FI664	30 x 72	1921.00
FI663	36 x 60	1921.00
FI662	36 x 72	2155.00

Model No.	Size D" x W"	Price /Each
<b>PLASTIC LAMINATE</b>		
FI671	24 x 60	1820.00
FI670	30 x 60	1873.00
FI669	30 x 72	1975.00
FI668	36 x 60	1975.00
FI667	36 x 72	2107.00

Model No.	Size D" x W"	Price /Each
<b>LAMINATED WOOD - 1 1/4"</b>		
FN038*	24 x 60	1328.00
FN037*	30 x 60	1401.00
FN036*	30 x 72	1479.00
FN035*	36 x 60	1479.00
FN034*	36 x 72	1570.00

\*1500-lb. capacity

## HEAVY-DUTY - 2500-LB. CAPACITY

**FI612 - Steel Wood Fill**



Model No.	Size D" x W"	Price /Each
<b>STEEL - WOOD FILL</b>		
FI616	24 x 60	952.00
FI615	30 x 60	971.00
FI614	30 x 72	1002.00
FI613	36 x 60	1002.00
FI612	36 x 72	1033.00

Model No.	Size D" x W"	Price /Each
<b>LAMINATED WOOD - 1 3/4"</b>		
FI621	24 x 60	918.00
FI620	30 x 60	1003.00
FI619	30 x 72	1086.00
FI618	36 x 60	1086.00
FI617	36 x 72	1182.00



## HEAVY-DUTY - 2500-LB. CAPACITY

**FI642 - Shop Top**



Model No.	Size D" x W"	Price /Each
<b>STEEL - WOOD FILL</b>		
FI636	24 x 60	1333.00
FI635	30 x 60	1353.00
FI634	30 x 72	1385.00
FI633	36 x 60	1385.00
FI632	36 x 72	1418.00

Model No.	Size D" x W"	Price /Each
<b>LAMINATED WOOD - 1 3/4"</b>		
FI641	24 x 60	1232.00
FI640	30 x 60	1323.00
FI639	30 x 72	1401.00
FI638	36 x 60	1401.00
FI637	36 x 72	1497.00



## HEAVY-DUTY - 2500-LB. CAPACITY

**FI677 - Laminated Wood**



Model No.	Size D" x W"	Price /Each
<b>STEEL - WOOD FILL</b>		
FI676	24 x 60	1336.00
FI675	30 x 60	1349.00
FI674	30 x 72	1380.00
FI673	36 x 60	1380.00
FI672	36 x 72	1411.00

Model No.	Size D" x W"	Price /Each
<b>LAMINATED WOOD - 1 3/4"</b>		
FI681	24 x 60	1286.00
FI680	30 x 60	1365.00
FI679	30 x 72	1448.00
FI678	36 x 60	1448.00
FI677	36 x 72	1546.00



Model No.	Size D" x W"	Price /Each
<b>SHOP TOP</b>		
FI686	24 x 60	1529.00
FI685	30 x 60	1640.00
FI684	30 x 72	1764.00
FI683	36 x 60	1764.00
FI682	36 x 72	1954.00

Model No.	Size D" x W"	Price /Each
<b>PLASTIC LAMINATE</b>		
FI691	24 x 60	1641.00
FI690	30 x 60	1719.00
FI689	30 x 72	1796.00
FI688	36 x 60	1796.00
FI687	36 x 72	1923.00

Model No.	Size D" x W"	Price /Each
<b>LAMINATED WOOD - 1 1/4"</b>		
FN043*	24 x 60	1196.00
FN042*	30 x 60	1268.00
FN041*	30 x 72	1347.00
FN040*	36 x 60	1347.00
FN039*	36 x 72	1438.00

\*1500-lb. capacity



IF YOU NEED SPECIFIC SIZES OR REQUIREMENTS NOT AVAILABLE ON THESE PAGES, SEE PAGES 126-129 OR CALL US TODAY WITH YOUR SPECS!

# WORKBENCHES



## HEAVY-DUTY - 2500-LB. CAPACITY

FI697 -  
Laminated Wood



Model No.	Size D" x W"	Price /Each
<b>STEEL - WOOD FILL</b>		
FI696	24 x 60	1399.00
FI695	30 x 60	1411.00
FI694	30 x 72	1442.00
FI693	36 x 60	1442.00
FI692	36 x 72	1481.00
<b>LAMINATED WOOD - 1 3/4"</b>		
FI701	24 x 60	1347.00
FI700	30 x 60	1431.00
FI699	30 x 72	1510.00
FI698	36 x 60	1510.00
FI697	36 x 72	1607.00



\*1500-lb. capacity

## HEAVY-DUTY - 2500-LB. CAPACITY

FG245 -  
Steel Wood Fill



Model No.	Size D" x W"	Price /Each
<b>STEEL - WOOD FILL</b>		
FG241	24 x 60	1511.00
FG242	30 x 60	1525.00
FG243	30 x 72	1561.00
FG244	36 x 60	1561.00
FG245	36 x 72	1598.00
<b>LAMINATED WOOD - 1 3/4"</b>		
FG233	24 x 60	1462.00
FG234	30 x 60	1540.00
FG235	30 x 72	1624.00
FG236	36 x 60	1624.00
FG237	36 x 72	1720.00



\*1500-lb. capacity

## HEAVY-DUTY - 2500-LB. CAPACITY

FG632 -  
Plastic Laminate



Model No.	Size D" x W"	Price /Each
<b>STEEL - WOOD FILL</b>		
FG628	24 x 60	1980.00
FG627	30 x 60	1993.00
FG626	30 x 72	2023.00
FG625	36 x 60	2023.00
FG624	36 x 72	2052.00
<b>LAMINATED WOOD - 1 3/4"</b>		
FG623	24 x 60	1931.00
FG622	30 x 60	2015.00
FG621	30 x 72	2095.00
FG620	36 x 60	2095.00
FG619	36 x 72	2192.00



\*1500-lb. capacity

## HEAVY-DUTY - 2500-LB. CAPACITY

FG137 -  
Steel Wood Fill



Model No.	Size D" x W"	Price /Each
<b>STEEL - WOOD FILL</b>		
FG132	24 x 60	1431.00
FG134	30 x 60	1443.00
FG135	30 x 72	1472.00
FG136	36 x 60	1472.00
FG137	36 x 72	1508.00
<b>LAMINATED WOOD - 1 3/4"</b>		
FG118	24 x 60	1443.00
FG120	30 x 60	1520.00
FG121	30 x 72	1600.00
FG122	36 x 60	1600.00
FG123	36 x 72	1689.00



\*1500-lb. capacity

## HEAVY-DUTY - 2500-LB. CAPACITY

FG469 -  
Shop Top



Model No.	Size D" x W"	Price /Each
<b>STEEL - WOOD FILL</b>		
FG468	24 x 60	1715.00
FG467	30 x 60	1727.00
FG466	30 x 72	1758.00
FG465	36 x 60	1758.00
FG464	36 x 72	1793.00
<b>LAMINATED WOOD - 1 3/4"</b>		
FG463	24 x 60	1666.00
FG462	30 x 60	1749.00
FG461	30 x 72	1830.00
FG460	36 x 60	1830.00
FG459	36 x 72	1926.00



\*1500-lb. capacity

## HEAVY-DUTY - 2500-LB. CAPACITY

FG221 -  
Laminated Wood



Model No.	Size D" x W"	Price /Each
<b>STEEL - WOOD FILL</b>		
FG225	24 x 60	1762.00
FG226	30 x 60	1769.00
FG227	30 x 72	1805.00
FG228	36 x 60	1805.00
FG229	36 x 72	1835.00
<b>LAMINATED WOOD - 1 3/4"</b>		
FG217	24 x 60	1715.00
FG218	30 x 60	1793.00
FG219	30 x 72	1872.00
FG220	36 x 60	1872.00
FG221	36 x 72	1969.00



\*1500-lb. capacity



IF YOU NEED SPECIFIC SIZES OR REQUIREMENTS NOT AVAILABLE ON THESE PAGES, SEE PAGES 126-129 OR CALL US TODAY WITH YOUR SPECS!

## EXTRA HEAVY-DUTY WORKBENCHES

### ALL-WELDED BENCHES

- All-welded construction features a wood-filled 3/16" steel top with 11 gauge steel legs and stringers
- Standard bolt-down footplates
- Mobile units come w/6" polyurethane casters, two swivel w/brakes, and two rigid
- Overall Height: 34"
- Capacity is based on evenly distributed weight
- Durable Kleton blue enamel finish



Model No.	Style	Dimensions				Cap. lbs.	Wt. lbs.	Price /Each	
		W"	x	D"	x	H"			
FF494	Static	72	x	30	x	34	5000	290	1329.00
FF495	Static	72	x	36	x	34	5000	295	1489.00
FH465	Mobile	72	x	30	x	34	3500	209	1695.00
FH466	Mobile	72	x	36	x	34	3500	360	1819.00

### PEDESTAL BENCHES

- Designed for workshop applications
- Feature 1 3/4" thick solid laminated hardwood top, mounted on two all-welded pedestals with two shelves each
- Pedestals are 18" W x 24" D x 32" H
- Overall Height: 34"
- Capacity is based on evenly distributed weight
- Durable Kleton blue enamel finish
- Shipped knocked down

**KLETON**



Model No.	Dimensions	Cap. lbs.	Wt. lbs.	Price /Each
	W" x D" x H"			
FF120	60 x 30 x 34	2500	157	1082.00
FF121	72 x 30 x 34	2500	174	1166.00
FF122	84 x 30 x 34	2500	184	1249.00
FF119	120 x 30 x 34	2500	275	1469.00

## HEAVY-DUTY STAINLESS STEEL WORKBENCHES

- Work surface is constructed of 14-gauge stainless steel with an 11-gauge support structure
- 1 5/8" diameter posts with tapered sleeves and corners
- Standard units are stationary with leveling foot on each post
- 30" models can be fitted with 5" polyurethane swivel casters, two with wheel brake
- Capacity is based on evenly distributed weight
- Shipped knocked down



F1388



F1391



## HEAVY-DUTY WORKBENCHES

- Top is 12 gauge reinforced steel
- Includes a 12 gauge steel lower shelf with 500 lbs. capacity
- Foot pads with predrilled holes allow lagging to the floor
- Durable textured powder coat finish
- Capacity: 4000 lbs.
- Configuration: Shelf
- Dimensions: 48" W x 30" D x 34" H
- Colour: Grey
- Weight: 202 lbs.

Model No. MO950  
Mfg. No. DWB-3048-95  
Price/Each \$1435.00

**DURHAM MFG**  
Est. 1922



**METRO**

Model No.	Description	Overall Dimensions				Cap. lbs.	Wt. lbs.	Price /Each	
		W"	x	D"	x	H"			
F1388	3-Sided Frame	60	x	30	x	34	625	104	2882.00
F1389	3-Sided Frame	72	x	30	x	34	750	121	3128.00
F1390	3-Sided Frame	96	x	30	x	34	1000	150	3743.00
F1391	H-Frame	60	x	30	x	34	625	104	2882.00
F1392	H-Frame	72	x	30	x	34	750	120	3128.00
F1393	H-Frame	96	x	30	x	34	1000	150	3743.00

Models are also available in 36" and 44" depths



# WORKBENCHES

## ERGONOMIC WORKSTATIONS

- Highly functional and flexible system of above-work surface accessories and modular components
- Ergonomically designed, delivering easy accessibility with no stretch or strain
- Modular design allows for easy reconfiguration

### Workstation benefits include:

- Greater productivity and efficiency
- Reduced strain and increased ergonomic ease
- Equipped to exactly suit your needs
- Properly illuminated work areas

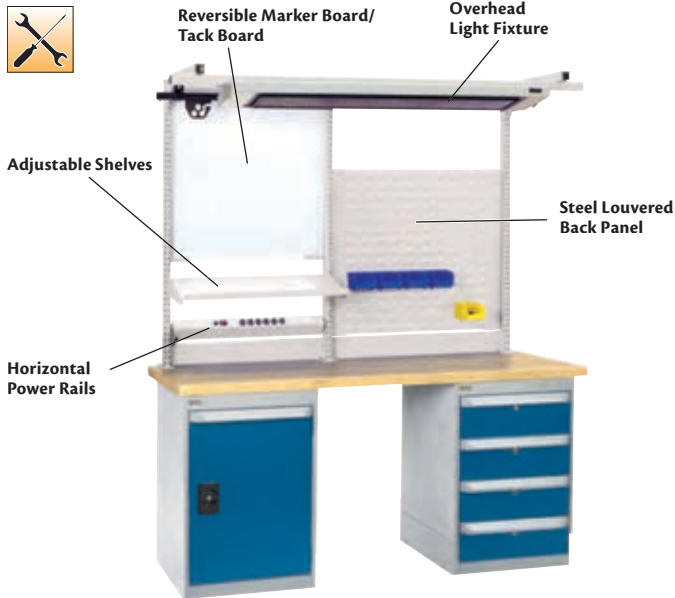

### TO PICK THE RIGHT FRAME FOR YOUR NEEDS YOU MUST DETERMINE THE FOLLOWING MEASUREMENTS:

**Section Width (A):** Is measured from the centre of one upright to the other.

**Overall Width (B):** Is measured from the outside of one foot plate to the other. Then determine if you require a single frame or double frame unit.

### SURFACE MOUNT FRAMES

- Frames are made from a heavy gauge steel and are notched front and back at 1" increments
- Foot plate is 2 3/4" x 4"

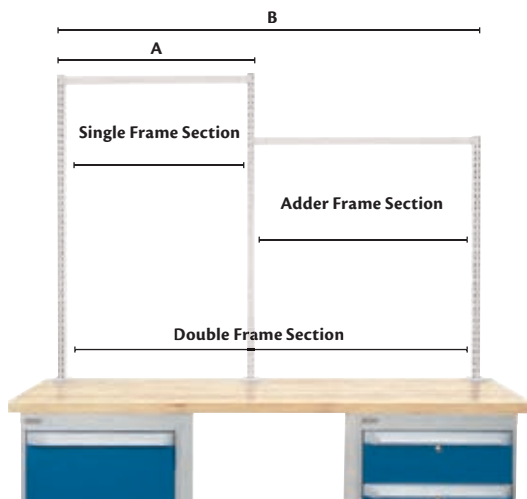

### SINGLE FRAME SECTIONS

Model No.	Height"	Section Width" (A)	Min Work Surface Width" Required	Price /Each
FI368	30	24	30	388.00
FI370	30	30	36	410.00
FH992	30	36	42	410.00
FI372	30	42	48	410.00
FH993	30	48	54	432.00
FI374	30	60	66	432.00
FI369	48	24	30	410.00
FI371	48	30	36	432.00
FH994	48	36	42	432.00
FI373	48	42	48	432.00
FH995	48	48	54	454.00
FI375	48	60	66	454.00

### ADDER FRAME SECTION

Model No.	Height"	Section Width" (A)	Min Work Surface Width" Required	Price /Each
FI376	30	24	54	259.00
FI378	30	30	60	281.00
FI380	30	36	66	281.00
FI382	30	42	72	281.00
FI384	30	48	78	302.00
FI386	30	60	90	302.00
FI377	48	24	54	281.00
FI379	48	30	60	302.00
FI381	48	36	66	302.00
FI383	48	42	72	302.00
FI385	48	48	78	324.00
FI387	48	60	90	324.00

### DOUBLE FRAME SECTIONS

Model No.	Height"	Section Width"	Min Work Surface Width" Required	Price /Each
FI747	30	24 + 24	54	544.00
FI749	30	24 + 30	60	562.00
FL525	30	24 + 36	66	562.00
FL526	30	24 + 42	72	562.00
FL527	30	24 + 48	78	580.00
FL528	30	24 + 60	90	580.00
FL529	30	30 + 30	66	580.00
FL530	30	30 + 36	72	580.00
FL531	30	30 + 42	78	580.00
FL532	30	30 + 48	84	599.00
FL533	30	30 + 60	96	599.00
FL534	30	36 + 36	78	580.00
FL535	30	36 + 42	84	580.00
FL536	30	36 + 48	90	599.00
FL537	30	36 + 60	102	599.00
FL538	30	42 + 42	90	580.00
FL539	30	42 + 48	96	599.00
FL540	30	42 + 60	108	599.00
FL541	30	48 + 48	102	617.00
FL542	30	48 + 60	114	617.00
FL543	30	60 + 60	126	617.00
FI748	48	24 + 24	54	580.00
FI750	48	24 + 30	60	599.00
FL544	48	24 + 36	66	599.00
FL545	48	24 + 42	72	599.00
FL546	48	24 + 48	78	617.00
FL547	48	24 + 60	90	617.00
FL548	48	30 + 30	66	617.00
FL549	48	30 + 36	72	617.00
FL550	48	30 + 42	78	617.00
FL551	48	30 + 48	84	636.00
FL552	48	30 + 60	96	636.00
FL553	48	36 + 36	78	617.00
FL554	48	36 + 42	84	617.00
FL555	48	36 + 48	90	636.00
FL556	48	36 + 60	102	636.00
FL557	48	42 + 42	90	726.00
FL558	48	42 + 48	96	744.00
FL559	48	42 + 60	108	744.00
FL560	48	48 + 48	102	654.00
FL561	48	48 + 60	114	654.00
FL562	48	60 + 60	126	763.00

## NEXUS SYSTEM WORKBENCH ACCESSORIES

### OVERHEAD CABINETS

- Steel cabinet with retractable locking door, includes mounting brackets, lock and two keys



Model No.	Overall Dimensions W" x D" x H"	Price /Each
FI364	24 x 15 x 16	1898.00
FI365	30 x 15 x 16	1889.00
FI366	36 x 15 x 16	2052.00
FI367	48 x 15 x 16	1959.00

### REPLACEMENT PARTS

FI362	Support Brackets for 16" Overall Height	125.00
-------	---	--------

### LED OVERHEAD LIGHT FIXTURE

- Features 8' grounded electrical cord, switch, support track, standard acrylic diffuser, and LED bulbs
- Fixture with additional brackets can also simultaneously support tool rail



Model No.	Use with Frame Overall Width"	Price /Each
FN423	48	969.00
FN424	60	1009.00

### SUPPORT BRACKETS

Model No.	Use with Frame Overall Depth"	Price /Each
FI327	Less than 30	195.00
FI328	Greater than or equal to 30	229.00

### HORIZONTAL POWER BOARDS

- 15 Amps with six plugs
- Pivots on axis providing full horizontal adjustability



Model No.	Overall Width"	Price /Each
FI022	24	385.00
FI023	30	395.00
FI024	36	399.00
FI025	48	415.00

### VERTICAL POWER BOARDS

- 15 Amps with six outlets
- Mounts vertically to front and back of upright
- Features a lighted on/off switch, 6' cord with grounded plug and circuit breaker
- Bracket and hardware included

Model No. FI021  
Price/Each \$279.00



### PLASTIC BOX RAILS

- Easily adjustable for ergonomic access
- Can be mounted either parallel or a 15° angle to the workstation
- Suitable to use with bins that have a rear lip
- Plastic bins not included



Model No.	Overall Width"	Price /Each
FI030	24	135.00
FI031	30	145.00
FI032	36	149.00
FI033	48	165.00

### ADJUSTABLE SHELVES

- Adjustable, heavy gauge steel shelves can be mounted parallel to the work surface or at a 15° angle for easy ergonomic access
- 100-lb. capacity evenly distributed



Model No.	Overall Dimensions W" x D"	Price /Each
FI001	24 x 12	209.00
FI002	30 x 12	215.00
FI003	36 x 12	219.00
FI004	48 x 12	229.00
FI005	24 x 15	245.00
FI006	30 x 15	249.00
FI007	36 x 15	255.00
FI008	48 x 15	269.00
FI009	24 x 18	319.00
FI010	30 x 18	325.00
FI011	36 x 18	335.00
FI012	48 x 18	365.00

### SHELF DIVIDERS

- Steel dividers fit over the edge of the shelf when it is mounted parallel to the work surface



Model No.	Overall Dimensions D" x H"	Price /Each
FI013	12 x 4	50.50
FI014	12 x 6	50.50
FI015	12 x 8	50.50
FI016	15 x 4	52.50
FI017	15 x 6	54.50
FI018	15 x 8	56.50

### STEEL LOUVERED BACK PANELS

- Designed to accommodate industry standard plastic bins that featured louvered edge or lip



Model No.	Overall Dim. W" x H"	Price /Each
FI034	24 x 18	375.00
FI035	30 x 18	395.00
FI036	36 x 18	435.00
FI037	48 x 18	539.00
FI038	24 x 30	419.00
FI039	30 x 30	435.00
FI040	36 x 30	495.00
FI041	48 x 30	599.00

### REVERSIBLE MARKERBOARDS/TACKBOARDS

- Two-sided reversible board
- Features white magnetic marker board on one side and grey fabric panel on the other



Model No.	Overall Dimensions W" x H"	Price /Each
FI050	24 x 30	489.00
FI051	30 x 30	635.00
FI052	36 x 30	669.00
FI053	48 x 30	909.00

### STEEL PEGBOARD PANELS

- Accepts all standard pegging devices
- Holes are 1/4" in diameter



Model No.	Overall Dim. W" x H"	Price /Each
FI042	24 x 18	319.00
FI043	30 x 18	375.00
FI044	36 x 18	399.00
FI045	48 x 18	409.00
FI046	24 x 30	455.00
FI047	30 x 30	459.00
FI048	36 x 30	545.00
FI049	48 x 30	669.00

OTHER SIZES AVAILABLE UPON REQUEST

# WORKBENCHES

## BUILD YOUR OWN MOBILE CABINET BENCHES

- Ideal for maintenance, repair and assembly departments
- Mount one, two or three cabinets from six choices of cabinets
- Heavy-duty 11-gauge steel base, 1 1/4" thick laminated hardwood top, and a push handle
- Four 5" non-marking casters with brakes for smooth, easy rolling
- Doors are reversible, can be opened either left or right side
- All locks keyed alike by pedestal model
- Capacity: 1200 lbs. evenly distributed
- Cabinet frame powder coat finish with grey shell and Kleton blue on doors and drawers
- Shipped knocked down



FH666

FH667

FH668

F1166

F1167

FH669

FH670

FH671

### CONFIGURE YOUR OWN UNIT BY CHOOSING:

1. The pedestal style(s) that suits your needs (to a maximum of three pedestal(s))
2. Add to that the assembly kit, whether it be single, double or triple. Assembly kit includes casters, base and 1 1/4" laminated hardwood top



Assembly Kit

Model No.	Description	Wt. lbs.	Price /Each
<b>1 - PEDESTAL STYLES COMPLETE WITH LOCK &amp; 2 KEYS</b>			
FH666	One door	51	375.00
FH667	Two half doors	52	445.00
FH668	Two small drawers and one half door	75	615.00
FH669	Four large drawers	97	749.00
F1166	Two large drawers	66	649.00
F1167	One large drawer and two small drawers	78	749.00
FH670	Four small drawers and one half door	84	815.00
FH671	Four small drawers and two large drawers	98	995.00
<b>2 - ASSEMBLY KITS</b>			
FH407	Single	35	459.00
FH408	Double	65	585.00
FH409	Triple	95	819.00

## SINGLE PEDESTAL BENCHES

- Heavy gauge steel cabinet with 1" round tube frame
- Top tray lined with a rubber mat
- Full extension drawers with a capacity of 100 lbs. per drawer
- Four 4" non-marking casters with brakes for smooth, easy rolling
- Comes complete with locks and two keys
- Overall dimensions 20" W x 21" D x 37" H
- Capacity: 800 lbs. evenly distributed
- Cabinet frame powder coat finish with grey shell and Kleton blue on doors and drawers



Model No.	Description	Wt. lbs.	Price /Each
FF984	4-drawer cabinet	120	1395.00
MH801	Single door cabinet	75	1085.00



FF984



MH801



## INDUSTRIAL DUTY MOBILE SERVICE BENCHES

- Designed for moving heavy parts and tools to the job site
- Four 5" non-marking casters: two rigids and two swivels with brake
- Provides a strong maintenance-free surface to work on
- 16-gauge all-welded steel construction
- Laminated hardwood top
- Overall Dimensions: 42" W x 24" D x 37"H
- Shell durable Kleton blue enamel finish
- Cabinets are powder paint grey and Kleton blue
- Shipped assembled
- Capacity: 1200 lbs. evenly distributed

**KLETON**



Model No.	Description	Wt. lbs.	Price /Each
ML325	2 Doors	237	2069.00
ML326	1 Drawer/1 Door	222	1889.00
ML327	4 Drawers/1 Door	316	2329.00
ML328	8 Drawers	300	2639.00

\* Review cabinet models on page 138 to create your own mobile service bench.



ML325



ML326



ML327



ML328

## MOBILE BENCH CABINET

- Heavy duty 16 ga. all-welded steel construction
- Convenient sturdy work surface
- Back and end stops on work surface prevents parts from falling during transport
- 5" x 1-1/4" polyurethane casters (2 swivel, 2 ridged)
- Durable, textured, grey powder coat finish
- Tubular handle for ease of mobility
- Cabinet door has a 3 point locking handle with 2 keys
- 1200 lbs. capacity (based on evenly distributed weight)
- Full piano hinge on door prevents door sag
- Note: Handle adds 6" to overall width

FL635



FL637

FI822



FI823



FL634



FG813



**DURHAM MFG**  
Est. 1922



FL638



FL636

Model No.	Workbench Type	Overall Dimensions					Cabinet Size					Drawer Dimensions					Price /Each
		W"	x	D"	x	H"	W"	x	D"	x	H"	W"	x	D"	x	H"	
FG813	2 Drawers & Cabinet	24	x	18	x	38-3/8	24	x	18	x	10-1/2	20-7/16	x	14-11/16	x	5-7/8	1749.00
FI822	Cabinet	24	x	18	x	38-3/8	23-7/8	x	17-7/8	x	27-7/16	-	-	-	-	-	1229.00
FI823	4 Drawers	24	x	18	x	38-3/8	-	-	-	-	20-7/16	x	14-11/16	x	5-7/8	2005.00	
FL634	1 Drawer & Cabinet	24	x	18	x	38-3/8	23-7/8	x	17-7/8	x	21-3/4	20-7/16	x	14-11/16	x	5-7/8	1259.00
FL638	2 Drawers & Cabinet	36	x	18	x	38-3/8	36	x	18	x	16-3/8	16-1/16	x	14-11/16	x	5-7/8	1759.00
FL637	1 Drawer & Cabinet	36	x	18	x	38-3/8	11-18	x	18	x	24-1/4	20-7/16	x	14-11/16	x	5-7/8	2105.00
FL635	Shelf, 1 Drawer & Cabinet	36	x	18	x	38-3/8	11-18	x	18	x	24-1/4	20-7/16	x	14-11/16	x	5-7/8	1609.00
FL636	Shelf, 1 Drawer & Cabinet w/Bins	36	x	18	x	38-3/8	11-18	x	18	x	24-1/4	20-7/16	x	14-11/16	x	5-7/8	1705.00

# WORKBENCHES

## MAXI-BENCH WORKSTATIONS

- Roll your workstation to your work area
- Sturdy 30" x 60" steel wood-filled top and all-welded 14-gauge frame
- Includes: 42" H peg board panel, double drawers, swivel-out stool, lower shelf, end stops
- Mobile units come with 5" nylon non-marking casters, two rigid and two swivel with brakes
- Models **FF068** and **FF071** include fluorescent lamp, 25' incandescent drop light, and 4-outlet power bar
- Capacity: 1200 lbs. evenly distributed
- Durable Kleton blue enamel finish



**KLETON**

Model No.	Description	Overall Height"	Wt. lbs.	Price /Each
<b>FF068</b>	Mobile, Complete	76	340	<b>3799.00</b>
<b>FF069</b>	Mobile, No Electrical	76	350	<b>3195.00</b>
<b>FF071</b>	Static, Complete	70	380	<b>3799.00</b>
<b>FF072</b>	Static, No Electrical	70	363	<b>3189.00</b>

## HEAVY-DUTY MACHINE STANDS

- Designed for use as machinery stand or work table when full-sized workbench is not necessary
- 14" shelf clearance
- All-welded construction
- 14-gauge steel lip-down shelves, with bolt-down footplates on 3/16" x 1 1/2" angle leg
- Capacity is based on evenly distributed weight
- Durable Kleton blue enamel finish



**KLETON**

Model No.	W"	x	D"	x	H"	Cap. lbs.	Wt. lbs.	Price /Each
<b>FH268</b>	30	x	18	x	32	1200	60	<b>275.00</b>
<b>FH269</b>	36	x	24	x	32	1200	70	<b>305.00</b>
<b>FH270</b>	48	x	24	x	32	1200	85	<b>335.00</b>

## ADJUSTABLE MACHINE STANDS

- Easy to assemble with the hardware provided
- Shelves adjust on 3" centers
- Work Surface: Steel
- Colour: Grey



**DURHAM MFG®**  
Est. 1922

Model No.	Mfg. No.	Dimensions W" x D" x H"	Maximum Adjustable Height"	Price /Each
<b>M0951</b>	MTA182424-1.5K295	18-1/8 x 24-1/8 x 18-1/8	24-1/8	<b>489.00</b>
<b>M0952</b>	MTA182436-1.5K295	18-1/8 x 24-1/8 x 30-1/8	36-1/8	<b>539.00</b>
<b>M0953</b>	MTA243024-1.5K295	24-1/8 x 30-1/8 x 18-1/8	24-1/8	<b>629.00</b>
<b>M0954</b>	MTA243036-1.5K295	24-1/8 x 30-1/8 x 30-1/8	36-1/8	<b>655.00</b>
<b>M0955</b>	MTA243624-1.5K295	24-1/8 x 36-1/8 x 18-1/8	24-1/8	<b>705.00</b>
<b>M0956</b>	MTA243636-1.5K295	24-1/8 x 36-1/8 x 30-1/8	36-1/8	<b>735.00</b>
<b>M0957</b>	MTA244824-1.5K295	24-1/8 x 48-1/8 x 18-1/8	24-1/8	<b>865.00</b>
<b>M0958</b>	MTA244836-1.5K295	24-1/8 x 48-1/8 x 30-1/8	36-1/8	<b>895.00</b>

## ADJUSTABLE MOBILE MACHINE STAND

- Easy to assemble with the hardware provided
- Shelves adjust on 3" centers
- Bottom shelf has 2" lip to retain products with a capacity of 500 lbs.
- Four 3" x 1-1/4" polyolefin swivel casters with side brakes
- Work Surface: Steel
- Colour: Grey



**DURHAM MFG®**  
Est. 1922

Model No.	Mfg. No.	Dimensions W" x D" x H"	Maximum Adjustable Height"	Price /Each
<b>M0959</b>	MTMA182428-1K23P095	18-1/8 x 24-1/8 x 21-13/16	27-13/16	<b>695.00</b>
<b>M0960</b>	MTMA182440-1K23P095	18-1/8 x 24-1/8 x 33-13/16	39-13/16	<b>745.00</b>
<b>M0961</b>	MTMA243028-1K23P095	24-1/8 x 30-1/8 x 21-13/16	27-13/16	<b>829.00</b>
<b>M0962</b>	MTMA243040-1K23P095	24-1/8 x 30-1/8 x 33-13/16	39-13/16	<b>865.00</b>
<b>M0963</b>	MTMA243628-1K23P095	24-1/8 x 36-1/8 x 21-13/16	27-13/16	<b>915.00</b>
<b>M0964</b>	MTMA243640-1K23P095	24-1/8 x 36-1/8 x 33-13/16	39-13/16	<b>939.00</b>
<b>M0965</b>	MTMA244828-1K23P095	24-1/8 x 48-1/8 x 21-13/16	27-13/16	<b>1059.00</b>
<b>M0966</b>	MTMA244840-1K23P095	24-1/8 x 48-1/8 x 33-13/16	39-13/16	<b>1099.00</b>

**MOVING YOU FORWARD**

**KLETON**

## WALL-MOUNTED SHOP DESK



- Durable carbon steel construction
  - Ideal for areas with limited floor space
  - Four compartment organizer and slightly sloped writing surface
  - Easy to assemble, wall brackets included
  - 23" W x 16" D x 3 1/2" H locking drawer on quiet nylon rollers
  - Overall Dimensions: 34 1/2" W x 28" D x 31" H
  - Weight: 74 lbs.
  - Grey enamel finish
- Model No. FI518**  
**Price/Each \$313.00**



## OPEN FLOOR STYLE SHOP DESK



- Durable carbon steel construction
  - Ideal for receiving/shipping clerks, watchmen and shop foremen
  - Four compartment organizer and slightly sloped 43" height writing surface
  - Optional caster kit to convert to mobile unit
  - 23" W x 16" D x 3 1/2" H locking drawer on quiet nylon rollers
  - Overall Dimensions: 34 1/2" W x 30" D x 53" H
  - Weight: 93 lbs.
  - Grey enamel finish
- Model No. FI519**  
**Price/Each \$399.00**

- OPTIONAL CASTER KIT**
- Model No. FI521**  
**Price/Each \$74.10**



## CABINET STYLE SHOP DESK



- Durable carbon steel construction
  - Same features as the open floor style shop desk, with an added double door locking cabinet
  - Four compartment organizer and slightly sloped 43" height writing surface
  - Optional caster kit to convert to mobile unit
  - 23" W x 16" D x 3 1/2" H locking drawer on quiet nylon rollers
  - Overall Dimensions: 34 1/2" W x 30" D x 53" H
  - Weight: 146 lbs.
  - Grey enamel finish
- Model No. FI520**  
**Price/Each \$568.00**



## SHOP DESK

- Heavy-duty 16 ga. all-welded steel construction
  - 18 gauge steel file drawers (2) and storage drawers (2)
  - Drawers included recessed handles, ball bearing slides & cylinder locks
  - Straight writing surface, 42" table top height
  - An 18" D x 23" W x 7" H shelf welded on top of work surface
  - Durable, textured, gray powder coat finish
  - Dimensions: 39" W x 29" D x 53" H
  - Colour: Grey
- Model No. FL633**  
**Price/Each \$3175.00**

**DURHAM MFG**  
Est. 1922



## SHOP DESK

- Heavy-duty 16 ga. all-welded steel construction
- Provides an organized work area that easily moves anywhere
- Sloped work surface has a pencil rest lip
- Drawer has ball bearing slides
- (4) 3" swivel rubber casters
- 500 lbs. overall capacity
- Dimensions: 23" W x 20" D
- Material: Steel
- Colour: Grey



**DURHAM MFG**  
Est. 1922

Model No.	Type	Height"	Price/Each
FG789	Cabinet Style	51	1329.00
FG790	Open Style	47 3/4	1109.00



# STORAGE CABINETS



## STORAGE CABINET

- Made of cold rolled steel sheets of commercial quality
- Features a lock
- Shelf Capacity: 150 lbs.
- Assembly Type: Welded (Assembled)
- Top Gauge: 20
- Door & Sides Gauge: 20
- Shelf Gauge: 20
- Bottom Gauge: 20
- Back Gauge: 24



Grey	Model No.		Description	Dimensions					Wt. lbs.	Price /Each
	Beige	Black		W	x	D	x	H		
FL787	FL789	FL788	Hi-Boy	36	x	18	x	72	140	1045.00
FL801	FL800	FL802	Additional Shelf	36	X	18	X	1	10	105.00
FL791	FL792	FL790	Wardrobe	36	x	18	x	72	116	1005.00
FL801	FL800	FL802	Additional Shelf	36	X	18	X	1	10	105.00
FL794	FL793	FL795	Combination	36	x	18	x	72	140	1255.00
FL801	FL800	FL802	Additional Shelf	36	X	18	X	1	10	105.00
FL783	FL785	FL784	Lo-Boy	36	x	18	x	40	116	799.00
FL804	FL803	FL805	Additional Shelf	36	X	18	X	1	10	105.00

## HEAVY-DUTY STORAGE CABINET

- Made of cold rolled steel sheets of commercial quality
- Features a lock
- No. of Shelves: 5
- Shelf Capacity: 150 lbs.
- Assembly Type: Welded (Assembled)
- Top Gauge: 20
- Door & Sides Gauge: 20
- Shelf Gauge: 20
- Bottom Gauge: 20
- Back Gauge: 22
- Colour: Grey



Model No.	Description	Dimensions					Wt. lbs.	Price /Each
		W"	x	D"	x	H"		
FL780	Heavy-Duty Cabinet	36	x	18	x	72	156	1465.00
FL807	Additional Shelf	36	x	18	x	1	15	175.00

## WALL HUNG STORAGE CABINET

- Made of cold rolled steel sheets of commercial quality
- Features a lock
- No. of Shelves: 2
- Shelf Capacity: 150 lbs.
- Assembly Type: Welded (Assembled)
- Top Gauge: 20
- Door & Sides Gauge: 20
- Shelf Gauge: 20
- Bottom Gauge: 20
- Back Gauge: 22



Model No.		Description	Dimensions					Wt. lbs.	Price /Each
Grey	Beige		W"	x	D"	x	H"		
FL781	FL782	Wall Hung Cabinet	36	x	12	x	30	54	779.00
FL821	FL803	Additional Shelf	36	x	12	x	1	10	105.00

## ALL-WELDED DEEP HI-BOY STORAGE CABINET

- Suitable for office, plant, school or institutional storage needs
- Four fully adjustable shelves
- Includes recessed handle and cylinder lock
- Shelf capacity: 150 lbs. evenly distributed



Model No.			Dimensions					Price /Each
Black	Beige	Charcoal	W"	x	D"	x	H"	
FJ882	FJ883	FJ884	36	x	24	x	72	919.00
<b>ADDITIONAL DEEP SHELF</b>								
FJ879	FJ880	FJ881	36	x	24	x	1	115.00

FJ884



## STORAGE CABINET

- Designed for easy assembly
- One-piece base serves as additional shelf
- Locking handle for added security
- Compact size
- Ships knocked down
- No. of Shelves: 4
- Colour: Grey
- Material: Steel
- Shelf Capacity: 300 lbs.

FN425



**KLETON**

Model No.	Dimensions					Wt. lbs.	Price /Each
	W"	x	D"	x	H"		
FN425	30	x	15	x	66	124	465.00
FN426	36	x	24	x	78	198	645.00
FN427	48	x	24	x	78	238	825.00

## HEAVY-DUTY PLASTIC CABINETS

- Durable resin construction is easy to clean, will not rust or crack
- Functional and modular organization
- Doors are lockable (locks not included)
- Quick assembly without tools
- Ventilated shelves hold 180 lbs. each

MH724



MH722



**Rubbermaid**  
Home Products



Model No.	Dimensions					No. of Shelves	Wt. lbs.	Price /Each
	W"	x	D"	x	H"			
MH722	36	x	18	x	72	3	55	573.00
MH724	36	x	18	x	37	1	28	395.00

## CABINET DOLLIES

- Durable steel construction
- Features swivel casters with locking brake
- Casters are non-marking, impact-resistant, and easy to maintain
- Capacity: 1000 lbs.
- Wheel Material: Polyolefin

MP888



**KLETON**

Model No.	Dimensions					Price /Each
	W"	x	D"	x	H"	
MP888	18	x	36	x	1-3/8	109.00
MP890	24	x	48	x	1-3/8	145.00

**MATRIX**  
INDUSTRIAL PRODUCTS

Maintain the ideal temperature in your workplace

# STORAGE CABINETS

## DEEP DOOR STORAGE CABINETS

- Padlock hasp (cannot be accessed by bolt cutters) helps secure the contents of this deep door high-density storage cabinet
- Four reinforced adjustable main shelves are complemented by six adjustable mini shelves in each 4" deep hinged door for a capacity unmatched by any other cabinet
- Padlock sold separately
- Capacity per shelf: 500 lbs evenly distributed



Special padlock hasp conceals padlocks from bolt cutters



**KLETON**

Model No.	Description	W" x D" x H"	Size D" x H"	Wt. lbs.	Price /Each
FB024	Cabinet	38 x 24 x 72	x -	315	2329.00
FB025	Extra shelf for cabinet	38 x 17 x -	x -	18	135.00
FB026	Extra shelf for door	18 x 6 x -	x -	2	50.50
SA898	Padlock keyed different	-	-	-	22.10
SR892	Padlock keyed alike	-	-	-	24.60

## EXTRA WIDE HI-BOY STORAGE CABINET

- Made of cold rolled steel sheets of commercial quality
- Features a lock
- No. of Shelves: 5
- Colour: Grey
- Shelf Capacity: 150 lbs.
- Assembly Type: Welded (Assembled)
- Top Gauge: 20
- Door & Sides Gauge: 20
- Shelf Gauge: 20
- Bottom Gauge: 20
- Back Gauge: 22



FL796



Model No.		Description	Dimensions			Wt. lbs.	Price /Each
Grey	Beige		W"	x D"	x H"		
FL786	FL796	Cabinet	48	x 24	x 72	215	2029.00
FL823	FL822	Additional Shelf	48	x 24	x 1	15	175.00

## CLEARVIEW CABINETS

- Clear polycarbonate windows so all your tools and supplies are visible at a glance
- 12-gauge one-piece body design
- 6" sweep space
- Adjustable 14-gauge shelves
- 3-point locking device
- Hinges are 8-gauge



Model No.	Dimensions W" x D" x H"	O. A. Ht"	No. of Shelves	Shelf Cap. lbs.	Wt. lbs.	Price /Each
FG851	48 x 24 x 60	66	3	1200	487	5709.00
FG852	48 x 24 x 72	78	4	1200	571	6099.00

## EXTRA HEAVY-DUTY STAINLESS STEEL CABINETS

- The strongest storage product available in the market today
- Made of 12-gauge, #304 stainless steel, with a #3 finish
- Corrosion-resistant, acid-resistant, will not rust and will take the everyday abuse in an industrial environment
- Shelves adjust on 2" centers
- 3-point locking system
- 7-gauge welded legs

These units can also be found in medical, pharmaceutical, automotive, electronics, textile, breweries, marine facilities, restaurants, etc.



Model No.	Dimensions W" x D" x H"	O.A. Ht"	No. of Shelves	Shelf Cap. lbs.	Wt. lbs.	Price /Each	Extra Shelf Model No.	Price /Each
FI340	36 x 24 x 60	66	3	1900	406	10809.00	FI349	503.00
FI341	36 x 20 x 72	78	4	1600	435	11639.00	FI350	488.00
FI342	36 x 24 x 72	78	4	1900	475	12499.00	FI349	503.00
FI343	48 x 24 x 60	66	3	1200	489	13009.00	FI351	656.00
FI344	48 x 24 x 72	78	4	1200	573	16989.00	FI351	656.00
FI345	60 x 24 x 60	66	3	1650	595	15439.00	FI352	979.00
FI346	60 x 24 x 72	78	4	1650	699	20209.00	FI352	979.00
FI347	72 x 24 x 60	66	3	1525	726	18389.00	FI353	1379.00
FI348	72 x 24 x 72	78	4	1525	856	21079.00	FI353	1379.00

CANADA'S LEADING  
MATERIAL HANDLING SUPPLIER





## DEEP DOOR COMBINATION CABINETS

- All-welded heavy-duty 16-gauge, combination bin/shelf cabinet
- 4" deep hinged doors
- Unique padlock hasp helps prevent access with bolt cutters
- Powder coated Kleton grey finish
- Padlock sold separately

## 84-BIN CABINETS

- Four reinforced 16-gauge main adjustable shelves with 500 lbs. capacity per shelf
- Incorporates louvered bin hanging panels welded into the cabinets doors

### CABINETS ONLY

Model No.	Description	Dimensions				Wt. lbs.	Price /Each
		W"	x	D"	x H"		
CB442	Cabinet only	38	x	24	x 72	324	2205.00
FB025	Extra shelf	38	x	17	-	18	135.00

### CABINET & BIN COMBINATIONS

Blue	Red	Model No.			Description	Wt. lbs.	Price /Each
		Yellow	Green				
CB446	CB477	CB448	CB693		Cabinet and plastic bins	341	2372.00

### BINS SUPPLIED

Bin Qty.	Bin Size				Capacity lbs.
	W"	x	D"	x H"	
84	4 1/8	x	5 3/8	x 3	10



CB446  
84 Bins



CF373  
96 Bins



CF354  
98 Bins

## 96-BIN CABINETS

- Two reinforced 16-gauge main adjustable shelves with 500 lbs. capacity per shelf
- Incorporates louvered bin hanging panels welded to the cabinet's back and doors

### CABINETS ONLY

Model No.	Description	Dimensions				Wt. lbs.	Price /Each
		W"	x	D"	x H"		
FH820	Cabinet only	38	x	24	x 72	316	2137.00
FB025	Extra shelf	38	x	17	-	18	135.00

### CABINET & BIN COMBINATIONS

Blue	Red	Model No.			Description	Wt. lbs.	Price /Each
		Yellow	Green				
CF371	CF372	CF373	CF374		Cabinet and plastic bins	359	2365.00

### BINS SUPPLIED

Bin Qty.	Bin Size				Capacity lbs.
	W"	x	D"	x H"	
84	4 1/8	x	5 3/8	x 3	10
12	5 1/2	x	10 7/8	x 5	30



CB445  
118 Bins

## 98-BIN CABINETS

- Two reinforced 16-gauge main adjustable shelves with 500 lbs. capacity per shelf
- Incorporates louvered bin hanging panels welded to the cabinet's back and door

### CABINETS ONLY

Model No.	Description	Dimensions				Wt. lbs.	Price /Each
		W"	x	D"	x H"		
FH820	Cabinet Only	38	x	24	x 72	316	2137.00
FB025	Extra Shelf	38	x	17	-	18	135.00

### CABINET & BIN COMBINATIONS

Blue	Red	Model No.			Description	Wt. lbs.	Price /Each
		Yellow	Green				
CF355	CF356	CF354	CF357		Cabinet and plastic bins	385	2546.00

### BINS SUPPLIED

Bin Qty.	Bin Size				Capacity lbs.
	W"	x	D"	x H"	
48	4 1/8	x	5 3/8	x 3	10
36	4 1/8	x	7 3/8	x 3	10
8	8 1/4	x	14 3/4	x 7	60
6	16 1/2	x	14 3/4	x 7	75

## 118-BIN CABINETS

- Incorporates louvered bin hanging panels welded to the cabinet's back and doors

### CABINETS ONLY

Model No.	Description	Dimensions				Wt. lbs.	Price /Each
		W"	x	D"	x H"		
CB441	Cabinet only	38	x	24	x 72	316	2135.00

### CABINET & BIN COMBINATIONS

Blue	Red	Model No.			Description	Wt. lbs.	Price /Each
		Yellow	Green				
CB443	CB444	CB445	CB691		Cabinet and plastic bins	385	2679.00

### BINS SUPPLIED

Bin Qty.	Bin Size				Capacity lbs.
	W"	x	D"	x H"	
42	4 1/8	x	5 3/8	x 3	10
42	4 1/8	x	7 3/8	x 3	10
18	5 1/2	x	10 7/8	x 5	30
12	8 1/4	x	14 3/4	x 7	60
4	16 1/2	x	14 3/4	x 7	75

# STORAGE CABINETS

## SHOP FURNITURE THAT'S BUILT LIKE A TANK!

There are times and environments that demand more than run-of-the-mill shop furniture. This is the time and place for Strong Hold. A line of shop furniture so durable and robust that it is accepted and demanded by industrial heavy weights. Major auto manufacturers use hundreds of these units!



A. FG816



B. FI331



C. FG830



D. FG836



E. FG838

### A. ROUGH & TOUGH STORAGE CABINETS

These heavy-duty 12-gauge steel models provide protection for valuable tools and machine parts. Built for "rough and tough" industrial use. Shelves are adjustable and more can be added for versatility.

Model No.	Width"	Depth"	Height"	O.A. Height"	Adjustable Shelves	Cabinet Wt. lbs.	Price /Each	Extra Shelf Model No.	Shelf Capacity lbs.	Price /Each
FG815	36	20	72	78	4	435	3929.00	FG821	1900	226.00
FG816	36	24	72	78	4	475	4099.00	FG821	1900	236.00
FG817	48	24	72	78	4	573	4959.00	FG822	1200	268.00
FG818	60	24	72	78	4	699	5599.00	FG823	1650	341.00
FG819	72	24	72	78	4	856	6589.00	FG824	1525	404.00

### B. HEAVY-DUTY VENTILATED STORAGE CABINETS

The 12-gauge steel doors are perforated with a diamond shape for easy visibility and ventilation. Ideal for industry, health clubs or any facility where personal belongings need to be securely locked and ventilated.

Model No.	Width"	Depth"	Height"	O.A. Height"	Adjustable Shelves	Cabinet Wt. lbs.	Price /Each	Extra Shelf Model No.	Shelf Capacity lbs.	Price /Each
FI329	36	24	72	78	4	470	4379.00	FG821	1900	236.00
FI330	48	24	72	78	4	568	5229.00	FG822	1200	268.00
FI331	60	24	72	78	4	666	5949.00	FG823	1650	341.00

### C. DOUBLE SHIFT STORAGE CABINETS

These space saving cabinets provide two separate storage compartments. Companies with a second shift can secure the first shift's valuables while the second shift is on duty. Also you can use one side for personal belongings and the other to store tools.

Model No.	Width"	Depth"	Height"	O.A. Shelf Height"	Adj. Shelf Per Each Side	Cabinet Wt. lbs.	Price /Each	Extra Shelf Model No.	Shelf Capacity lbs.	Price /Each
FG829	48	24	72	78"	4	642	5529.00	FG832	600	146.00
FG830	60	24	72	78"	4	740	6049.00	FG833	825	156.00
FG831	72	24	72	78"	4	838	6719.00	FG834	765	173.00

### D. BROOM CLOSET STORAGE CABINETS

Organize your housekeeping needs with our broom closet cabinets. As heavy-duty as the rest of the Strong Hold line, double doors permit full access to all shelves. Closet side stores long handled floor care items. Use side shelves to store paper products, cleaners and brushes. Shelves can be adjusted or removed to accommodate large pails.

Model No.	Width"	Depth"	Height"	O.A. Height"	Adjustable Shelves	Cabinet Wt. lbs.	Price /Each	Extra Shelf Model No.	Shelf Capacity lbs.	Price /Each
FG835	36	24	72	78	4	492	4379.00	FG845	1150	205.00
FG836	48	24	72	78	4	580	5289.00	FG846	700	226.00
FG837	60	24	72	78	4	659	5989.00	FG847	975	251.00

### E. WARDROBE/STORAGE CABINETS

This cabinet fits into the heavy-duty line up as the answer to clothing storage with tools and supplies. 3-point latching mechanism adds extra protection.

Model No.	Width"	Depth"	Height"	O.A. Height"	Adjustable Shelves	Cabinet Wt. lbs.	Price /Each	Extra Shelf Model No.	Shelf Capacity lbs.	Price /Each
FG838	36	24	72	78	4	501	4499.00	FG845	450	205.00
FG839	48	24	72	78	4	594	5379.00	FG846	700	226.00
FG840	60	24	72	78	4	687	6119.00	FG847	975	251.00

# STORAGE CABINETS



F. FG844



G. FG852



H. FG850



I. FG827



J. FG842

## F. CABINET SHOP DESKS

Heavy-duty shop desk, with a 29" W x 20" D and 6" H drawer. Includes a lockable hasp separate from the 3-point locking system in the cabinet doors.

Model No.	Width"	Depth"	Writing Height"	O.A. Height"	Drawer Capacity lbs.	Cabinet Wt. lbs.	Price /Each	Extra Shelf Model No.	Shelf Capacity lbs.	Price /Each
FG844	36	28	42	54	400	373	4419.00	FG849	1900	240.00

## G. CLEARVIEW CABINETS

Keep a watchful eye on valuable items. Cabinets come equipped with clear polycarbonate windows for viewing items stored inside, without opening the doors.

Model No.	Width"	Depth"	Height"	O.A. Height"	Adjustable Shelves	Cabinet Wt. lbs.	Price /Each	Extra Shelf Model No.	Shelf Capacity lbs.	Price /Each
FG852	48	24	72	78"	4	571	6099.00	FG822	1200	268.00

## H. CORNER CABINETS

This 12-gauge all-welded corner cabinet eliminates corner clutter. Store those odd shaped tools in this space saving unit which comes with four adjustable 14-gauge shelves and a hasp for padlock. The extra wide door provides access to both sides of the corner shelves.

Model No.	Width"	Depth"	Height"	O.A. Height"	Cabinet Wt. lbs.	Price /Each	Extra Shelf Model No.	Shelf Capacity lbs.	Price /Each
FG850	48	24	72	78	805	11279.00	FG854	1400	457.00

## I. COUNTER TOP STORAGE CABINETS

Counter top units provide ample storage for heavy tools and supplies on two adjustable shelves. These space saving units are sold without legs. Most frequently they are placed on a table to bring the storage up to a working height. Drawers or casters can be added as options.

Model No.	Width"	Depth"	Height"	O.A. Height"	Cabinet Wt. lbs.	Price /Each	Extra Shelf Model No.	Shelf Capacity lbs.	Price /Each
FG825	24	20	36	36	184	2469.00	FG828	1900	188.00
FG826	36	20	36	36	267	3069.00	FG820	1900	226.00
FG827	36	20	42	42	292	3269.00	FG820	1900	226.00

## J. SHOP TABLES

Tables designed to meet virtually every strength requirement for heavy manufacturing. Tops are 7-gauge steel and legs are from 2" x 2" x 1/4" angle.

Model No.	Width"	Depth"	O.A. Height"	Capacity lbs	Wt. lbs.	Price /Each
FG841	48	30	34	5500	201	2129.00
FG842	72	36	34	10 000	298	2559.00

## ACCESS CONTROL CABINET

- Recessed standard doors
- Adjustable shelves
- No. of Shelves: 4
- Colour: Grey
- Material: Steel
- Finish: Textured Powder Coat
- Locking Mechanism: Electronic (Audit Trail)

**DURHAM MFG**  
Est. 1922



Model No.	Mfg. No.	Dimensions Height" Width" Depth"	Gauge	Shelf Capacity lbs.	Shelf Dimensions"	Price /Each
MP900	3702PL-4S-95	78 36 24	14	1900	33-15/16 x 20-7/8	4425.00
MP901	3703PL-4S-95	78 48 24	14	1200	45-15/16 x 20-7/8	5195.00
MP902	3704PL-4S-95	78 60 24	14	1650	57-15/16 x 20-7/8	5795.00
MP903	HDCPL-243678-4S-95	78 36 24	12	1900	33-15/16 x 20-7/8	5139.00
MP904	HDCPL-244878-4S-95	78 48 24	12	1200	45-15/16 x 20-7/8	5419.00
MP905	HDCPL-246078-4S-95	78 60 24	12	1650	57-15/16 x 20-7/8	6689.00



# STORAGE CABINETS

## WALL-MOUNTED CABINET

- 18-gauge, all-welded steel construction
- Features 2 adjustable shelves that adjust on 2" increments
- Locking system with keys included
- Features keyhole slots in back of unit for wall mounting
- Ships fully assembled
- Grey, gloss powder coat finish
- Includes: Mounting Hardware
- No. of Shelves: 2
- Colour: Grey
- Shelf Capacity: 150 lbs.



FL997

**DURHAM MFG**  
Est. 1922

Model No.	Dimensions					Weight lbs.	Price /Each
	W"	x	D"	x	H"		
FL997	27	x	13-11/16	x	18	52	505.00
FL998	27	x	13-11/16	x	35-7/8	88	779.00
FL992	29-7/8	x	13-11/16	x	27	77	695.00

## ABRASIVE STORAGE CABINET WITH PEGBOARD

- Features 2 adjustable shelves and keyhole slots in the back of the unit for wall mounting
- Shelves adjust on 1-7/8" increments
- Durable, textured, gray powder coat finish
- Ships fully assembled
- Features recyclable, biodegradable, and/or recycled content, and reduced resource use or waste in the production of product
- Colour: Grey
- Material: Steel
- Includes: (10) 8" Pegboard Hooks, (2) Adjustable Shelves
- Shelf Dimensions: 19-5/8" x 12-13/16"



**DURHAM MFG**  
Est. 1922

Model No.	Dimensions					Price /Each
	W"	x	D"	x	H"	
TER219	19-7/8	x	14-1/4	x	32-3/4	269.00

## ABRASIVE ACCESSORY CABINET

- Unit has key hole slots in the back and can be wall mounted or rest on a counter top
- Includes pegboard and (5) 6" peg hooks
- 1 sand paper / wire rod
- (2) 4" Pull out slots for sand paper
- 6 removable dividers can be adjusted on 2" centers
- All welded, steel construction
- Ships fully assembled
- Grey, gloss, powder coat finish
- Locking system with keys included
- Keyhole slots in the back of the unit for wall mounting
- Perfect for storing additional sand paper sheets or other accessories
- Bottom slotted shelves can be removed for general storage
- Colour: Grey
- Material: Steel
- No. of Drawers: 2



**DURHAM MFG**  
Est. 1922

Model No.	Dimensions					Weight lbs.	Price /Each
	W"	x	D"	x	H"		
FL996	33-3/4	x	11-7/8	x	23-7/8	56	535.00

## UTILITY CABINET

- These handy cabinets can be used to store a wide range of maintenance items
- Keyhole slots in back allow wall hanging
- Lock attachment is built in, hasp has diameter of 1/4"
- Colour: Grey
- No. of Shelves: 3
- Shelf Capacity: 35 lbs.
- Assembly Type: Welded (Assembled)
- Sections: 2 Adjustable

### CB636:

- Includes handle and hasp for padlock (padlock not included)

### CB637:

- Includes a lock and 2 keys



CB636

**DURHAM MFG**  
Est. 1922

Model No.	Dimensions					Weight lbs.	Price /Each
	W"	x	D"	x	H"		
CB636	13-1/4	x	12-3/4	x	30	31	275.00
CB637	19-7/8	x	14-1/4	x	32-3/4	41	355.00

## 100 SERIES ROLLING TOOL CHEST

- Full-extension ball-bearing drawer slides for smooth operation
- Four 50 lb. load capacity drawers
- 500 lb. load rating with four 4" x 2" casters
- Keyed internal locking system safeguards tools
- Non-slip open weave top mat helps protect the cabinet surface
- Full-width black steel drawer trim for grip
- All-steel construction provides strength and durability
- 8,030 cubic inches of storage capacity
- No. of Drawers: 4
- Colour: Black



**STANLEY**

Model No.	Dimensions					Price /Each
	W"	x	D"	x	H"	
TER042	26-1/2	x	18	x	32	335.00

## PRO+ SERIES ROLLER CABINET

- Heavy-duty 100 lbs. bearing slides standard on all drawers
- Completely redesigned locking system with tubular key
- Automotive style powder coat paint finish for superior scratch and chemical resistance
- Redesigned side handle makes moving roller cabinets easy and comfortable
- No. of Drawers: 4
- Colour: Red



**GRAY TOOLS**

Model No.	Dimensions					Price /Each
	W"	x	D"	x	H"	
NKE061	33-3/4	x	11-7/8	x	23-7/8	955.00

## AEROSOL STORAGE CABINET

- Used for storage of up to 48 standard-sized aerosol cans (24/shelf)
- Two independently sliding shelves slide in and out easily on 75 lb. capacity bearing slides
- All-welded steel construction
- Includes: Pre-installed lock and (2) keys
- Modular with Durham Large Slide Rack Cabinets
- Durable grey powder-coat finish
- No. of Shelves: 2
- Colour: Grey
- Shelf Capacity: 75 lbs.
- Assembly Type: Welded (Assembled)
- Weight: 45 lbs.



**DURHAM MFG**  
Est. 1922

Model No.	Mfg. No.	Dimensions				Price /Each	
		H"	x	W"	x		D"
FN379	300-95	21-7/8	x	15-15/16	x	20-5/16	659.00

## EXTRA HEAVY-DUTY CABINET

- Extra heavy-duty, all welded 12 gauge steel construction
- 3-point cast steel locking handle with 3/8" diameter rods and provision for a padlock (padlock not provided)
- Shelves bolt into place easily using fasteners provided and adjust on 2-1/2" centers
- Full height flush doors with 8 gauge leaf hinges to prevent sagging
- 6"H base/legs which provide access for forklifts; pre-drilled holes constructed of 3/16" steel allow for lagging to the floor
- Durable grey powder coat finish
- No. of Shelves: 3
- Colour: Grey
- Material: Steel
- Assembly Type: Welded (Assembled)



**DURHAM MFG**  
Est. 1922

Model No.	Mfg. No.	Dimensions				Shelf Capacity lbs.	Weight lbs.	Price /Each	
		H"	x	W"	x				D"
FM012	HDC-243666-3595	66	x	36	x	24	400	415	3529.00
FM013	HDC-244866-3595	66	x	48	x	24	300	485	4179.00
FM014	HDC-246066-3595	66	x	60	x	24	400	580	4785.00

## EXTRA HEAVY-DUTY WARDROBE CABINET

- Extra heavy-duty all welded 12 gauge steel construction
- 3-point cast steel locking handle with 3/8" diameter rods and provision for a padlock (padlock not provided)
- 6"H base/legs which provide access for forklifts; pre-drilled holes constructed of 3/16" steel allow for lagging to the floor
- Shelves bolt into place easily using fasteners provided and adjust on 2-1/2" centers
- Cabinets include 4 adjustable shelves and rod for hanging apparel
- Ships assembled and ready for use
- Durable gray powder coat finish
- No. of Shelves: 5
- Colour: Grey
- Material: Steel
- Assembly Type: Welded (Assembled)



**DURHAM MFG**  
Est. 1922

Model No.	Mfg. No.	Dimensions				Shelf Capacity lbs.	Weight lbs.	Price /Each	
		H"	x	W"	x				D"
FM019	HDWC244878-7M95	78	x	48	x	24	1900	720	7339.00
FM020	HDWC246078-5S95	78	x	60	x	24	1200	640	4685.00

## UTILITY CABINET

- These handy cabinets can be used to store a wide range of maintenance items
- Can be locked for security
- Includes a lock and 2 keys
- No. of Shelves: 1
- Colour: Grey
- Material: Steel
- Shelf Capacity: 150 lbs.
- Assembly Type: Welded (Assembled)
- Sections: 4
- Weight: 45 lbs.



**DURHAM MFG**  
Est. 1922

Model No.	Mfg. No.	Dimensions				Price /Each	
		H"	x	W"	x		D"
CB577	343-95	22-1/4	x	33-3/4	x	8-1/2	335.00

## HEAVY-DUTY OUTDOOR CABINET

- Extra heavy-duty all welded 12 gauge steel construction
- Doors open 180 degrees and have 7 gauge leaf hinges to prevent sagging
- 3-point cast steel locking handle with 3/8" diameter rods and provision for a padlock (not provided)
- 6" high box style legs, made using 3/16" steel, offer space for forklift truck forks and allow lagging to the
- Weather resistant, includes sloped top, a rain guard, gasket sealed door frames and filtered vents to keep out moisture and dust
- Shelves bolt into place easily using fasteners provided and adjust on 2-1/2" centers
- Ships assembled and ready for use
- Durable grey powder coat finish
- No. of Shelves: 4
- Colour: Grey
- Material: Steel
- Assembly Type: Welded (Assembled)



**DURHAM MFG**  
Est. 1922

Model No.	Mfg. No.	Dimensions				Shelf Capacity lbs.	Weight lbs.	Price /Each	
		H"	x	W"	x				D"
FM016	HDC0244878-4S95	78	x	48	x	24	300	580	6739.00
FM017	HDC0246078-4S95	78	x	60	x	24	400	680	7855.00

## EXTRA HEAVY-DUTY SLIDE-OUT SHELF CABINET

- Extra heavy duty, all welded 12-gauge steel
- 3-point locking system with pad-lockable (not included) cast steel locking handle
- Pullout shelves come installed and have a weight capacity of 400 lbs. each
- Distance between shelves is 11-5/8"
- Full height flush doors with 7 gauge leaf hinges to prevent sagging
- Pegboard holes are punched on 1" centers and accommodate standard peg hooks
- 16 gauge steel pegboard panels are welded to both doors
- 6"H base/legs provide access for forklifts; pre-punched holes allow for lagging to the floor
- Grey, textured powder coat finish
- Includes: 4 Pull-Out Shelves & 6 Drawers
- No. of Shelves: 4
- Colour: Grey
- Material: Steel
- Shelf Capacity: 400 lbs.
- Assembly Type: Welded (Assembled)
- Weight: 810 lbs.



**DURHAM MFG**  
Est. 1922

Model No.	Mfg. No.	Dimensions				Price /Each	
		H"	x	W"	x		D"
FM015	HDCDP244878-4SS6B95	78	x	48	x	24	8099.00

# LOCKERS

## READY TO ASSEMBLE STEEL LOCKERS

- Ships knocked down, ready to assemble with nuts and bolts included
- 16-gauge frames, 24-gauge body and shelves
- Durable powder-coated grey paint finish
- Number plates available separately
- Single Tier Dimensions: 12" W x 18" D x 72" H
- Double Tier Door Height: 33 1/4"
- Lockerettes Door Height: 11"



16-gauge frames, 24-gauge body and shelves

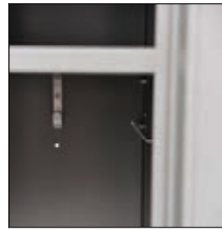

Three zinc-plated coat hooks and one shelf included with single and double tier lockers



Stainless steel recessed padlock handles  
Magnetic latch ensures door is properly fastened when closed



Double pan construction doors, 20-gauge outer and 24-gauge inner pans (single & double tier)

### SINGLE TIER

Model No.	Bank of	Wt. lbs.	Price /Each
-----------	---------	----------	-------------

#### BASIC STYLE

FL362	1	52	255.00
FL363	2	96	450.00
FL364	3	139	650.00

#### W/SLOPE TOP

FL380	1	56	285.00
FL381	2	104	510.00
FL382	3	151	745.00

#### W/RAISED BASE

FL392	1	56	285.00
FL393	2	104	510.00
FL394	3	151	745.00

#### W/SLOPE TOP & RAISED BASE

FL404	1	60	315.00
FL405	2	112	540.00
FL406	3	163	770.00



### DOUBLE TIER

Model No.	Bank of	Wt. lbs.	Price /Each
-----------	---------	----------	-------------

#### BASIC STYLE

FL366	1	54	275.00
FL367	2	98	485.00
FL368	3	141	725.00

#### W/SLOPE TOP

FL384	1	57	305.00
FL385	2	106	540.00
FL386	3	153	815.00

#### W/RAISED BASE

FL396	1	57	305.00
FL397	2	106	540.00
FL398	3	153	815.00

#### W/SLOPE TOP & RAISED BASE

FL408	1	61	335.00
FL409	2	114	570.00
FL410	3	176	845.00



### LOCKERETTES

Model No.	Bank of	Wt. lbs.	Price /Each
-----------	---------	----------	-------------

#### BASIC STYLE

FL370	1	60	360.00
FL371	2	108	675.00
FL372	3	159	1020.00

#### W/SLOPE TOP

FL388	1	66	380.00
FL389	2	119	725.00
FL390	3	175	1095.00

#### W/RAISED BASE

FL400	1	65	380.00
FL401	2	118	725.00
FL402	3	174	1095.00

#### W/SLOPE TOP & RAISED BASE

FL412	1	71	410.00
FL413	2	129	750.00
FL414	3	190	1125.00



### ACCESSORIES

Model No.	Description	Price /Each
FL375	10" Slope Top	29.95
FL374	4" Raised Base	29.95
FL376	Nuts & Bolts, Set of 1	0.10
FL518	Number Plates (Set of 1 to 25)	20.95
FL519	Number Plates (Set of 26 to 50)	20.95
FL520	Number Plates (Set of 51 to 75)	20.95
FL521	Number Plates (Set of 76 to 100)	20.95



#### SLOPE TOP

- Helps eliminate dust build up
- Raises top by 10"

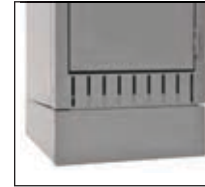

#### RAISED BASE

- Prevents liquids from entering the locker
- Raises locker 4" off the ground

## LOCKERS

- 16-gauge frames, 24-gauge body and shelves
- Double pan construction doors, 20-gauge outer and 24-gauge inner pans
- Stainless steel recessed padlock handles
- Magnetic latch ensures door is properly fastened when closed
- Three zinc-plated coat hooks and one shelf included with single and double tier lockers
- Durable powder-coated grey paint finish
- Number plates available separately
- No. of Tiers: 3
- Door Height: 33-1/4"
- Door Width: 9-7/8"
- Colour: Grey
- Material: Steel
- Top Style: Basic
- Base Style: Unfinished
- Assembly Type: Knocked Down
- Perforated/Non-Perforated: Non-Perforated

FN472



## GEAR LOCKER

- Lower shelf saves space as it also functions as a locker room bench
- Ventilated sides for optimal air flow
- Lockable safety box and foot locker for secure storage
- Coat rod and hooks provide ample room for hanging uniforms, bags, and other gear, while the upper and lower shelves provide plenty of flat storage area
- Door/Foot locker - 14 Gauge
- Shelf/Side & Top Panels/ Security box - 16 Gauge
- Colour: Grey
- Material: Steel

FN467



FN468



Model No.	Bank of	Overall Width"	Overall Depth"	Overall Height"	Price /Each
FN472	1	12	18	72	310.00
FN473	2	24	18	72	585.00
FN474	3	36	18	72	825.00



Model No.	Overall Depth"	Overall Height"	Overall Width"	Price /Each
<b>GEAR LOCKER WITH DOOR</b>				
FN467	24	72	24	720.00
<b>GEAR LOCKERS NO DOOR</b>				
FN468	24	72	24	635.00
FN469	18	72	24	570.00



## 16-DOOR ARCHETTES

- Ideal for confined spaces
- 16 lockable compartments
- Bar for hanging garments
- Compartment dimensions: 12" W x 18" D x 12" H
- Overall dimensions: 72" W x 18" D x 72" H
- Padlock hasp
- Other colours & custom sizes available upon request
- Mounting hardware not included
- **FJ175:** Coat bar and fasteners included



Model No.	Description	Colour	Wt. lbs.	Price/Each
FJ175	Pop Rivet Assembled	Light Grey	165	1915.00
FL359	All-Welded	Grey	180	2695.00
FL360	All-Welded	Charcoal	180	2695.00

## LOCKER ROOM BENCHES

- Necessary for any locker room
- Features black powder coated legs that can be used free-standing, or bolted to the floor (wood-top locker benches)

FB002



RL871



KLETON

Model No.	Dimensions			Type	Wt. lbs.	Price /Each
	L" x W" x H"					
FB002	72 x 12 x 17			Steel	35	399.00
RL871	48 x 9 1/2 x 16 1/2			Wood	23	305.00
RL872	60 x 9 1/2 x 16 1/2			Wood	28	327.00
RL873	72 x 9 1/2 x 16 1/2			Wood	31	350.00
RL874	96 x 9 1/2 x 16 1/2			Wood	38	396.00

## ASSEMBLED LOCKERS

- 16-gauge frames, 24-gauge body and shelves
- Double pan construction doors, 20-gauge outer and 24-gauge inner pans
- Stainless steel recessed padlock handles
- Magnetic latch ensures door is properly fastened when closed
- Features three zinc-plated coat hooks and one shelf
- Durable powder-coated grey paint finish
- Number plates available separately
- Door Width: 9-7/8"
- Colour: Grey
- Material: Steel
- Top Style: Basic
- Base Style: Unfinished
- Assembly Type: Rivet (Assembled)
- Non-Perforated



KLETON

Model No.	No. of Tiers	Bank of	Overall Dimensions W" x D" x H"	Door Height"	Weight lbs.	Price /Each
FN460	1	1	12 x 18 x 72	66-5/8	51.7	350.00
FN461	1	2	24 x 18 x 72	66-5/8	96	555.00
FN462	1	3	36 x 18 x 72	66-5/8	139	820.00
FN463	2	1	12 x 18 x 72	33-1/4	53.9	375.00
FN464	2	2	24 x 18 x 72	33-1/4	98	630.00
FN465	2	3	36 x 18 x 72	33-1/4	141	925.00

## WALL HUNG LOCKERS

- All-welded
- All-in-one storage for clothing and personal effects
- Four compartments measuring 12" W x 18" D x 12" H
- Baked enamel grey finish



Model No.	Colour	Price/Each
FJ919	Light Grey	809.00
FL357	Grey	1055.00
FL358	Charcoal	1055.00

## LOCKER BASE INSERTS

- Cost-effective corrosion-proof plastic
- Durable and maintenance-free
- Material: Plastic

Model No.	Colour	Dimensions L" x W"	Height"	Price /Each
FL591	Dark Grey	12 x 18	0.5	36.50
FI720	Light Grey	12 x 18	0.5	35.50
FI721	Beige	12 x 18	0.5	36.80
FI722	Black	12 x 18	0.5	36.50
FL658	Dark Grey	12 x 15	0.5	36.80
FL659	Light Grey	12 x 15	0.5	36.80
FL660	Beige	12 x 15	0.5	36.80
FL661	Black	12 x 15	0.5	36.80
FL662	Dark Grey	10 x 18	0.5	36.80
FL663	Light Grey	10 x 18	0.5	36.80
FL664	Beige	10 x 18	0.5	36.80
FL665	Black	10 x 18	0.5	36.80

Les Entreprises  
**Charlize**  
FONDS DE CABER  
LOCKER BOTTOMS



BEFORE



AFTER

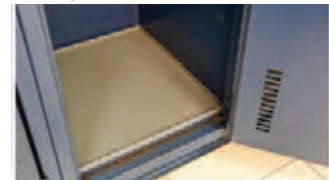

# LOCKERS

## CLEAN LINE™ LOCKERS

- Fully assembled, prime grade cold rolled steel locker
- All-welded frame with riveted panels and doors
- 20-gauge double pan construction doors, 16-gauge frames, 24-gauge bodies and shelves
- Dimensions: 12" W x 18" D x 72" H
- Single tier locker includes:**  
One hat shelf, three coat hooks and aluminum recessed padlock handle
- Double and Triple lockers include:**  
Two coat hooks per opening and aluminum recessed padlock handle
- All components coated in environmentally friendly polyester epoxy powder paint in pearl grey



- Ventilation holes on frame cross piece
- 20-gauge steel doors
- 16-gauge steel frame
- Aluminum recessed padlock handle



Bank of 1

Bank of 2

Bank of 3

Bank of 4



### SLOPE TOP

Slope top prevents the collection of debris and is easier to maintain against the accumulation of dust



### RECESSED BASE

Raises locker 4" off the floor

### DIFFERENT LOCK OPTIONS



Built-In Key Lock



Digital



Coin System



### SINGLE TIER

Model No.	Bank of	Price /Each
<b>BASIC STYLE</b>		
FJ151	1	335.00
FJ152	2	605.00
FJ153	3	905.00
FJ154	4	1205.00
<b>W/SLOPE TOP</b>		
FJ176	1	375.00
FJ177	2	679.00
FJ178	3	1015.00
FJ179	4	1355.00
<b>W/RECESSED BASE</b>		
FJ224	1	375.00
FJ225	2	679.00
FJ226	3	1015.00
FJ227	4	1355.00
<b>W/SLOPE TOP &amp; RECESSED BASE</b>		
FJ200	1	409.00
FJ201	2	749.00
FJ202	3	1125.00
FJ203	4	1499.00
<b>W/PERFORATED DOORS</b>		
FJ478	1	369.00
FJ479	2	669.00
FJ480	3	1005.00
FJ481	4	1335.00

### DOUBLE TIER

Model No.	Bank of	Price /Each
<b>BASIC STYLE</b>		
FJ155	1	355.00
FJ156	2	649.00
FJ157	3	969.00
FJ158	4	1295.00
<b>W/SLOPE TOP</b>		
FJ180	1	395.00
FJ181	2	719.00
FJ182	3	1079.00
FJ183	4	1439.00
<b>W/RECESSED BASE</b>		
FJ228	1	395.00
FJ229	2	719.00
FJ230	3	1079.00
FJ231	4	1439.00
<b>W/SLOPE TOP &amp; RECESSED BASE</b>		
FJ204	1	429.00
FJ205	2	795.00
FJ206	3	1189.00
FJ207	4	1585.00
<b>W/PERFORATED DOORS</b>		
FJ482	1	389.00
FJ483	2	709.00
FJ484	3	1065.00
FJ485	4	1419.00

### TRIPLE TIER

Model No.	Bank of	Price /Each
<b>BASIC STYLE</b>		
FJ159	1	455.00
FJ160	2	839.00
FJ161	3	1259.00
FJ162	4	1679.00
<b>W/SLOPE TOP &amp; RECESSED BASE</b>		
FJ208	1	525.00
FJ209	2	989.00
FJ210	3	1479.00
FJ211	4	1975.00
<b>W/PERFORATED DOORS</b>		
FJ486	1	485.00
FJ487	2	905.00
FJ488	3	1359.00
FJ489	4	1809.00

### ACCESSORIES

Model No.	Description	Price /Each
FJ930	Cylinder Lock	31.90
FJ685	Coat Rod	27.90
FL587	Number Plates (Set of 1 to 25)	54.50
FL588	Number Plates (Set of 26 to 50)	54.50
FL589	Number Plates (Set of 51 to 75)	54.50
FL590	Number Plates (Set of 76 to 100)	54.50

### LOCKERETTES

Model No.	Bank of	Price /Each
<b>BASIC STYLE</b>		
FJ171	1	559.00
FJ172	2	1055.00
FJ173	3	1585.00
FJ174	4	2109.00
<b>W/PERFORATED DOORS</b>		
FJ490	1	595.00
FJ491	2	1119.00
FJ492	3	1679.00
FL353	4	2325.00

### FREE STANDING BASE

- Ideal for making the underneath of your lockers accessible for cleaning
- Constructed of 16-gauge steel legs and frame
- Grey



Model No.	For Bank of	Dimensions W" x D" x H"	Price /Each
FJ931	1	12 x 18 x 6	60.90
FJ932	2	24 x 18 x 6	125.00
FJ933	3	36 x 18 x 6	185.00
FJ934	4	48 x 18 x 6	245.00

## ALL-WELDED CONCORDE™ LOCKERS

- All-welded heavy-duty cold-rolled steel construction
- Dimensions: 12" W x 18" D x 72" H
- 16-gauge door frame
- 20-gauge double wall door with ventilation
- 11-gauge hasp with easy padlock accessibility
- **Single tier lockers include:**
  - One hat shelf and three coat hangers
- **Double and triple lockers include**
  - two coat hooks per opening
- Coat hooks are rounded and polished to avoid damage to clothing
- Magnetic latch for secure door closing
- Contemporary style ventilated louvers (12 holes of 1" x 1/4") on each door
- High quality baked on enamel charcoal grey paint (light grey and beige also available)



Magnet in door strike ensures doors will remain closed

Full length handle

Incorporated ventilation on the doors

20-gauge double panelled door

14-gauge hinge

22-gauge galvanized steel bottom



Bank of 1

Bank of 2

Bank of 3

Bank of 4



Slope top



Recessed base



Different Lock Options



### SINGLE TIER LOCKERS

Model No.	Bank of	Price /Each
<b>BASIC STYLE</b>		
FJ783	1	535.00
FJ784	2	915.00
FJ785	3	1295.00
FJ786	4	1715.00
<b>W/SLOPE TOP</b>		
FJ787	1	599.00
FJ788	2	1055.00
FJ789	3	1499.00
FJ790	4	1985.00
<b>W/RECESSED BASE</b>		
FJ791	1	599.00
FJ792	2	1055.00
FJ793	3	1499.00
FJ794	4	1985.00
<b>W/SLOPE TOP &amp; RECESSED BASE</b>		
FJ795	1	669.00
FJ796	2	1195.00
FJ797	3	1705.00
FJ798	4	2259.00

### DOUBLE TIER LOCKERS

Model No.	Bank of	Price /Each
<b>BASIC STYLE</b>		
FJ799	1	645.00
FJ800	2	1159.00
FJ801	3	1579.00
<b>W/SLOPE TOP</b>		
FJ803	1	715.00
FJ804	2	1295.00
FJ805	3	1785.00
<b>W/RECESSED BASE</b>		
FJ807	1	715.00
FJ808	2	1295.00
FJ809	3	1785.00
<b>W/SLOPE TOP &amp; RECESSED BASE</b>		
FJ811	1	779.00
FJ812	2	1429.00
FJ813	3	1989.00

### TRIPLE TIER LOCKERS

Model No.	Bank of	Price /Each
<b>BASIC STYLE</b>		
FJ815	1	735.00
FJ816	2	1375.00
FJ817	3	1929.00
<b>W/SLOPE TOP</b>		
FJ823	1	805.00
FJ824	2	1515.00
FJ825	3	2139.00
<b>W/RECESSED BASE</b>		
FJ819	1	805.00
FJ820	2	1515.00
FJ821	3	2139.00
<b>W/SLOPE TOP &amp; RECESSED BASE</b>		
FJ827	1	869.00
FJ828	2	1645.00
FJ829	3	2339.00

### LOCKERETTES

Model No.	Bank of	Price /Each
<b>BASIC STYLE</b>		
FK872	1	1055.00
FK873	2	2035.00
FK874	3	2899.00

### ACCESSORIES

Model No.	Description	Price /Each
FL639	Number Plates (Set of 1 to 25)	195.00
FL640	Number Plates (Set of 26 to 50)	195.00
FL641	Number Plates (Set of 51 to 75)	195.00
FL642	Number Plates (Set of 76 to 100)	195.00



# PALLETS

## RETAIL DISPLAY PALLETS

- Modular
- This pallet offers marketers an attractive display solution with efficient material handling
- Easily creates in-aisle or end-of-aisle displays
- The flat, smooth surface allows for easy set up in a warehouse or co-packing facility
- Can be moved directly to sales floor to reduce labor costs and maximize storage space
- Decreases safety liabilities and product shrink by eliminating sharp edges, splinters and nails found in wood alternatives
- Pallet Entry: 4-Way
- ISPM 15 exempt



MN709

**ORBIS**

Model No.	Dimensions					Capacity lbs.		Wt. lbs.	Price /Each
	L"	x	W"	x	H"	Static	Dynamic		
MN709	24	x	24	x	5.5	8000	1000	9	75.00
MN713	48	x	24	x	5.5	15 000	2000	19	139.00
MN710	48	x	48	x	5.5	20 000	4000	38	249.00
MN712	48	x	40	x	5.5	30 000	4000	39.3	295.00

## STACKABLE PLASTIC PALLETS

- Economic, environmental and efficient alternative to wood pallets
- Smooth surfaces and lack of sharp edges protect workers from injury
- Nearly 100% of the content is recoverable for use in new pallets
- Produced from recycled material
- ISPM 15 exempt
- Includes runners
- Pallet Entry: 4-Way
- Colour: Black



**ORBIS**

Model No.	Dimensions					Capacity lbs.		Wt. lbs.	Price /Each
	L"	x	W"	x	H"	Static	Dynamic		
CG031	48	x	40	x	5.6	6500	2300	20	127.00

## NESTABLE SINGLE-FACED PALLETS

- One piece structural foam pallets are lightweight, nestable and recyclable
- High density polyethylene construction
- Large rectangular legs make it an excellent choice for most conveyor systems
- Stacks 15 high in only 48" for cost effective transport
- Fork lift: 4-ways
- Pallet truck: 4-ways
- Colour: Black
- ISPM 15 exempt

**ORBIS**



Model No.	Dimensions					Capacity lbs.		Wt. lbs.	Price /Each
	L"	x	W"	x	H"	Static	Dynamic		
CB524	48	x	48	x	5 3/4	30 000	4000	45.5	325.00

## SMALL-FORMAT PALLET

- 30" pallet width provides access through narrow doorways and is easy to manoeuvre
- Designed to optimize the supply chain of small retailers
- Generous clearance for forklifts to de-nest a full stack of pallets
- Added efficiency with molded-in stretch wrap notches in each pallet corner
- Recyclable
- Truckload Quantity (53' trailer): 1,845
- Material: Plastic
- Colour: Black



**ORBIS**

Model No.	Dimensions					Capacity lbs.		Pallet Entry	Wt. lbs.	Price /Each
	L"	x	W"	x	H"	Static	Dynamic			
CF933	42	x	30	x	6	10 000	2000	4-Way	20	133.00

## XPRESSPAL® HD NESTABLE PALLETS

- For moving, storing, and distributing product loads within a single warehouse or distribution center, or an entire supply chain
- Structural foam molded
- Recyclable
- Pallet Entry: 4-Way
- Colour: Black



**ORBIS**

Model No.	Dimensions					Capacity lbs.		Wt. lbs.	Price /Each
	L"	x	W"	x	H"	Static	Dynamic		
CG120	48	x	40	x	5.8	30 000	4000	35	261.00

## PALLET DOLLY

- Fits most standard pallets up to 42" x 48"
- Can be used with loaded or empty pallets
- (4) 6" swivel polyurethane casters, (2) with brakes
- Rugged, angle iron construction with load retention corner brackets
- Capacity: 3000 lbs.
- Width: 48.5"
- Depth: 43"
- Height: 8"

Model No. MP044  
Price/Each \$549.00



**KLETON**

## RACKOCELL PLASTIC PALLETS

- Designed to store products in wide variety of unsupported racking systems and optimize valuable floor space in warehouses and distribution systems
- Features flow-through deck for thorough sanitizing and fast drying capabilities
- Plastic pallet offers an economic, environmental and efficient alternative to wood pallets or skids
- Optional fork tine grommets (8) and outer post grommets (4) available upon request
- Pallet Entry: 4-Way
- Colour: Black

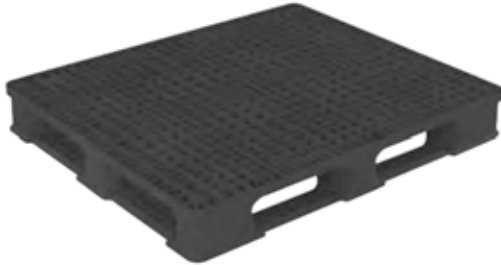

### ORBIS

Model No.	Dimensions				Capacity lbs.		Price /Each	
	L"	x	W"	x	Static	Dynamic		
CG004	48	x	40	x	6.3	30000	5000	468.00

## STACK'R MD PALLETS

- Open Deck With Stringer
- Designed specifically for stacking and racking applications
- Made of 100% HDPE
- The smooth, non-porous construction protects product and does not absorb moisture or odor
- Pallet Entry: 4-Way
- ISPM 15 exempt



### ORBIS

Model No.	Dimensions				Capacity lbs.		Wt. lbs.	Price /Each
	L"	x	W"	x	Static	Dynamic		
MN726	48	x	40	x	5.9	30000	4000	415.00

## DOUBLE DECK STACKABLE PALLETS

- Designed for handling and shipping heavy products
- Manufactured in HDPE structural foam
- An economic, environmental and efficient alternative to wood pallets or skids
- Double deck design, ideal for stack loading, conveying systems, distribution and static storage
- 4-way entry for fork and hand trucks
- ISPM 15 exempt



### ORBIS

Model No.	Dimensions				Capacity lbs.		Wt. lbs.	Price /Each	
	L"	x	W"	x	Static	Dynamic			
MN168	48.7	x	45.7	x	7.5	30000	4000	62	496.00

## RACKSTAR II™ PALLET

- Highly impact resistant design
- Internal reinforcements meet aggressive application requirements
- 100% recyclable with fully removable reinforcement structure
- Solid wall design for increased durability
- 4-way forklift accessible
- Easy to sanitize
- Removable/repairable stringers or full frame bottom, with easy-to-replace fasteners, are available for added capacity in forklift and conveyor use
- Rackable
- ISPM 15 exempt

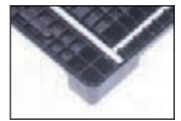

Rackstar II™ Pallet

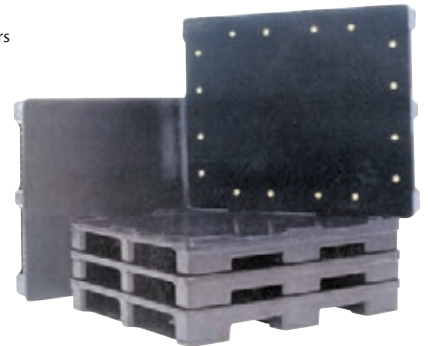

### ORBIS

Model No.	Dimensions L" x W" x H"	Description	Capacity lbs.		Capacity lbs.			Wt. lbs.	Price /Each
			Static	Dynamic	Decking	Centre Supports	Edge Supported		
CC163	48 x 40 x 6	Without lip (includes 16 deck grommets)	30000	6000	6000	6000	3000	56.6	725.00

## EXTRA-LONG STACKABLE PALLETS

- Pallet is fully reversible for double stacking of loads
- Manufactured in HDPE structural foam
- Designed for handling and shipping heavy product loads
- Ideal for stack loading, conveying systems, distribution and static storage
- 4-way entry for fork trucks
- ISPM 15 exempt



### ORBIS

Model No.	Dimensions				Capacity lbs.		Wt. lbs.	Price /Each	
	L"	x	W"	x	Static	Dynamic			
MN170	72	x	48	x	5.8	30000	4000	110	989.00

## STACK'R LD PALLETS

- Open deck with stringer
- Designed specifically for stacking applications
- Made of 100% recycled content
- Lower per-trip cost than alternative pallets
- Versatile handling with 4-way hand and fork truck entry
- Lighter weight for better ergonomics
- ISPM 15 exempt



### ORBIS

Model No.	Dimensions				Capacity lbs.		Wt. lbs.	Price /Each	
	L"	x	W"	x	Static	Dynamic			
MN714	48	x	40	x	5.9	30000	4000	44.4	336.00

# PALLETS

## ALUMINUM PALLETS

- Welded aluminum construction provides superb weight-to-load ratio
- Ideal for heavy industrial, food, electronics, telecommunications, pharmaceuticals and consumer goods
- Long service life indoors and outdoors, lightweight and low maintenance
- Resists fire, freezing temperatures, chemicals, rust and insects
- Always looks clean, easy to wash and sterilize
- Works seamlessly with automated and mechanized material handling equipment
- 2-way fork entry, ridged deck boards provide grip to reduce load shifting

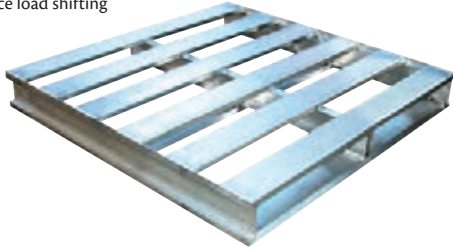

Model No.	Dimensions					Capacity lbs.		Wt. lbs.	Price /Each
	L" x W" x H"	x	x	x	x	Static	Dynamic		
CF416	48 x 42 x 6	x	x	x	x	6000	4000	40	685.00
CF417	48 x 48 x 6	x	x	x	x	6000	4000	50	719.00

## PALLET COVERS

- Protect palletized products from dust and moisture
- For use with stretchwrap



Model No.	Strength	Colour	Qty /Roll	Price /Each
JG739	Regular	Clear	250	114.00
JG740	Heavy-Duty	Clear	250	169.00
JG741	Regular	Black	250	109.00

## EDGEBOARD CORNER PROTECTORS

Improves stocking strength and cushions package edges against hard knocks.

Also helps improve the flow of strapping and stretch film around the product.

20/package.

Pallet quantities are available. Other thicknesses & lengths available upon request.



## PRE-BUNDLED PACKS

Model No.	Leg"	Thickness"	Length"	Price /Each
PB264	2.5 x 2.5	0.200	36	57.00
PB265	2.5 x 2.5	0.200	42	64.80
PB266	2.5 x 2.5	0.200	48	71.90
PB267	3 x 3	0.200	36	60.70
PB268	3 x 3	0.200	42	71.30
PB269	3 x 3	0.200	48	78.90

## PALLET RACK BACK GUARDS

Back guards help prevent accidents by keeping pallets and their contents from falling off the back of the rack. These guards increase safety where pedestrian pathways are behind the rack.

- Constructed using a 10-gauge frame, and 2" x 2", 10-gauge wire mesh with stiffeners
- Available in a variety of sizes to fit most pallet rack configurations
- Guard brackets are designed to fit almost any style of rack
- Durable safety yellow finish
- Hardware not included

ML231



KD131



### Create a pallet rack back guard designed for your application

1. Choose one or a combination of back guard panels to create the required width and length

Model No.	Dimensions'	Weight lbs.	Price /Each
KH926	1 x 4	10	115.00
KH914	2 x 4	12	77.60
KH930	3 x 4	20	175.00
KD130	4 x 4	23	105.00
KD131	8 x 4	45	180.00

2. Choose a mounting bracket that provides the required depth

- Minimum of four brackets required

Model No.	Dimensions"	Weight lbs.	Price /Each
ML231	4 x 6	2	23.90
ML232	4 x 9	2	26.50
ML233	4 x 12	3	26.50

3. Hardware required

For each additional panel, add: 2 x MMB721 and 2 x MMH254

For each mounting bracket, add: 3 x MMP624 and 3 x MMB721

## WIRE DECKING

- Easy to install
- Step/Waterfall style
- Three channels sit on beam to carry the load
- Capacity: 2500 lbs.

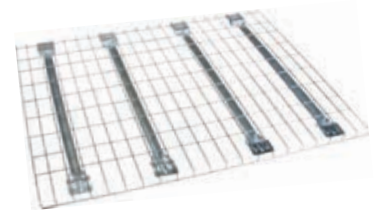

Model No.	Dimensions			Price /Each
	W"	x	D"	
RN768	46	x	36	53.75
RN769	52	x	36	59.95
RN770	46	x	42	65.00
RN771	52	x	42	69.95



## BAR STORAGE RACKS

All-steel vertical and horizontal racks are ideal for storing bars, tube, pipe and angle.

### HORIZONTAL BAR RACKS

- Horizontally stores bars up to 10' long 9" deep arms with 9 storage levels at 6" intervals
- O.A. Dim.: 18" W x 40" D x 84" H
- Capacity: 1800 lbs.
- Weight: 68 lbs.
- Durable Kleton blue enamel finish
- Shipped knocked down

**Model No. RB958**  
**Price/Each \$779.00**



### COMBINATION VERTICAL RACKS

- Vertically stores bars up to 12' long
- 3 shelves for extra storage of small parts
- 8" deep arms divided into 3 sections
- O.A. Dim.: 36" W x 24" D x 84" H
- Capacity: 3000 lbs.
- Weight: 128 lbs.
- Durable Kleton blue enamel finish
- Shipped knocked down

**Model No. RL922**  
**Price/Each \$450.00**



### VERTICAL BAR RACKS

- All-welded steel construction
- Vertically stores bars up to 10' long
- Four - 24" deep dividers
- O.A. Dim.: 48" W x 24" D x 60" H
- 3000 lbs. capacity
- Weight: 100 lbs.
- Durable Kleton blue enamel finish

**Model No. RL383**  
**Price/Each \$829.00**



### MOBILE PIPE & BAR RACKS

- All-welded steel construction, ready to use
- 3 double sided storage levels with 7" high uprights to secure load
- Useable space per side 6"-11"-15" (top-middle-bottom)
- Durable Kleton blue enamel finish
- Capacity: 3000 lbs.
- Capacity is based on evenly distributed weight
- Wheel Material: Polyurethane



Model No.	Overall Dim.					Wt. lbs.	Price /Each
	W"	x	D"	x	H"		
M0248	48	x	36	x	60	205	1115.00
M0249	72	x	36	x	60	245	1205.00

## STANDARD VERTICAL SHEET RACKS

- All-welded steel construction
- Designed for vertically storing sheet goods
- Constructed of heavy gauge steel 1 1/4" tube for bays and a heavy gauge steel 1" x 2" rectangular tube for the frame
- Each bay can hold up to 1000 lbs.
- O.A. Dim.: 84" W x 50" L x 36 3/4" H
- Number of bays: 4
- Distance between bays: 10"
- Weight: 200 lbs.
- Durable Kleton blue enamel finish

**Model No. RL384**  
**Price/Each \$1749.00**



## VERTICAL SHEET STORAGE RACKS

- Accommodates multiple sheet sizes
- All-welded steel construction, 1 1/4" OD round tube dividers
- Two 27" H uprights, two 36" H uprights and one 42" H upright
- Four equal size openings of 7 1/2" clear
- Holes for anchoring to the floor recommended
- Overall dimensions: 36" x 48" x 43 1/2"
- Capacity: 750 lbs. per bay; total of 3000 lbs.
- Shipping weight: 72 lbs.
- Durable Kleton blue enamel finish

**Model No. RN014**  
**Price/Each \$645.00**



## HORIZONTAL SHEET RACKS

- Designed for storage of sheet materials
- Flat storage fully supports materials and reduces warping
- Sheets are accessible from all four sides
- All-welded construction and the frame is made of 2" square tubing
- Five shelf design creates four storage bays spaced 9 1/2" apart and a open top bay
- Bay Capacity: 2000 lbs. evenly distributed
- Maximum rack capacity: 8000 lbs.



Model No.	Overall Dim.			Number of Shelves	Net Wt. lbs.	Price /Each
	L"	x	H"			
RL923	103	x	55 x 48	5	575	3149.00



## BUILT TO YOUR SPECIFIC DIMENSIONS

**Kleton** specializes in custom requests, be it a small modification to existing designs or a unique requirement. Our team of design specialists can help you get from concept, to drawings, to a finished product. From quantities of one to one thousand, Kleton treats your request with the same attention to detail that has become synonymous with the Kleton name.

# RACKING & SHELVING

## STACKING RACKS

- Rugged all-welded 2" sq. tubing steel construction
- Utilize warehouse airspace and lower the chances of damage that is associated with bulk stacking
- Designed for storage of loose and palletized goods
- Holds 4000 lbs. per rack and can be stacked 4 high
- Durable Kleton blue enamel finish
- Posts and bases are sold separately

KLETON

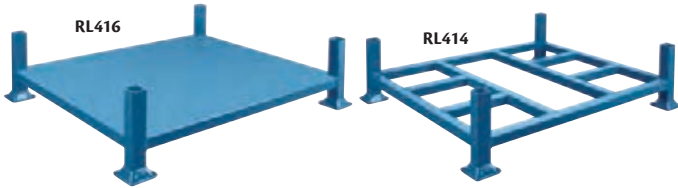

Model RL414  
w/2 Model RL419

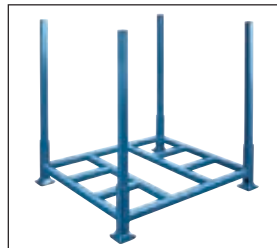

Model RL414  
w/4 Model RL421

Model No.	Inside Dimensions W" x D"	O.A. Dimensions W" x D"	Wt. lbs.	Price /Each
<b>OPEN BASE FRAME</b>				
RL414	44 x 38	48 x 42	85	545.00
RL415	44 x 44	48 x 48	90	609.00
<b>CLOSED BASE FRAME</b>				
RL416	44 x 38	48 x 42	110	649.00
RL417	44 x 44	48 x 48	115	715.00

### ACCESSORIES

Model No.	Description	O.A. Dimensions W" x H"	Wt. lbs.	Price /Each
RL418	42" Side Rail	42 x 48	30	169.00
RL419	48" Side Rail	48 x 48	32	175.00
RL420	42" Upright Post-Pack of 4	2 x 42	35	195.00
RL421	48" Upright Post-Pack of 4	2 x 48	40	209.00
RL422	60" Upright Post-Pack of 4	2 x 60	50	259.00

## RACKING AISLE PROTECTORS

- Prevent collision damage to shelving/racking from fork lifts, pallet trucks or other in-plant vehicle accidents
- Corner wraps are 12" high with an angle of 5" H x 3" W x 1/4" D with four holes for anchoring to the floor
- Protectors can be customized to any other lengths and/or depths required
- Floor anchors not included
- Colour: Safety yellow
- Material: Steel

RN059



KLETON K CUSTOM

Model No.	Description	O.A. Dimensions L" x W" x H"	Fits Upright	Wt. lbs.	Price /Each
RN059	Single Wrap - Left	46 1/2 x 3 x 12	42 W	38	239.00
RN060	Single Wrap - Right	46 1/2 x 3 x 12	42 W	38	239.00
RN061	Single Wrap - Left	52 1/2 x 3 x 12	48 W	41	249.00
RN062	Single Wrap - Right	52 1/2 x 3 x 12	48 W	41	249.00
RN063	Double Wrap	50 1/4 x 3 x 12	42 W	46	359.00
RN064	Double Wrap	56 1/4 x 3 x 12	48 W	46	395.00

## FLOOR ANGLE GUARD RAILS

- Floor angle guide rail helps keep traffic away from racking and shelving, walls, storage areas, offices, and other work areas
- The sturdy 5" H x 3" W x 1/4" D angle iron comes with holes to anchor to the floor
- Protectors can be customized to any other lengths and/or depths required
- Floor anchors not included
- Colour: Safety yellow
- Material: Steel



KLETON K CUSTOM

Model No.	O.A. Dimensions L" x W" x H"	Wt. lbs.	Price /Each
RN065	48 x 3 x 5	26	119.00
RN066	60 x 3 x 5	33	135.00
RN067	120 x 3 x 5	66	249.00

## SAFETY GUARDS

- Protect your equipment and personnel from accidental damage and injury with these low profile safety guards
- 4" x 4" square tube welded to an 8" x 8" x 1/2" base, complete with four 3/4" diameter holes for anchoring to floor
- Colour: Safety yellow powder coat finish

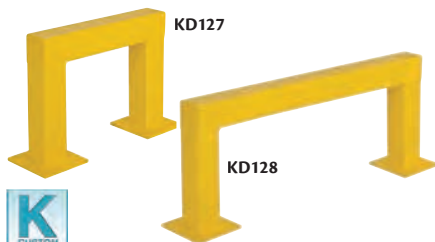

Model No.	Dimensions L" x H"	Wt. lbs.	Price /Each
KD127	24 x 18	65	419.00
KH855	36 x 18	75	515.00
KD128	48 x 18	85	485.00
KD136	24 x 42	95	545.00
KD139	48 x 42	115	599.00

KLETON

## UPRIGHT PROTECTORS

- Protects industrial racking from damaging impacts that cause unsafe conditions
- Made from 1/4" thick steel
- 4 pre-drilled holes made for 1/2" anchors (not included)
- Safety yellow powder coated finish



Model No.	O.A. Dimensions W" x D" x H"	Wt. lbs.	Price /Each
KH858	7 x 7 x 12	12	46.95
RB925	7 x 7 x 18 1/4	15	63.95

## HEAVY-DUTY STEEL BOLLARDS

- Protect your warehouse equipment, as well as high traffic areas with these heavy-duty steel bollards
- 4" x 4" square tube welded to an 8" x 8" x 1/2" steel base complete with four 3/4" diameter holes for anchoring to floor
- Safety yellow powder coated finish



Model No.	Height"	Wt. lbs.	Price /Each
KD125	24	30	179.00
KH857	36	40	209.00
KD126	48	50	215.00

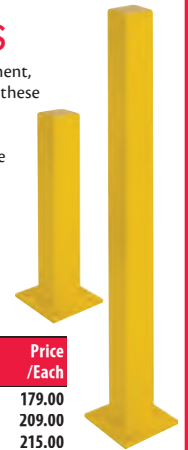

## HEAVY-DUTY SHELVING

- Excellent storage for heavy materials
- Open style shelving gives clear access from all sides
- Grey powder coat finish, Ships knocked down
- Shelf capacity based on evenly distributed loads
- Kit Type: Starter
- No. of Shelves: 5
- Shelf Capacity: 3000 lbs.
- Material: Steel
- Shelving Unit Type: Boltless



**KLETON**

Model No.	Dimensions					Wt. lbs.	Price /Each
	W"	x	D"	x	H"		
RN772	36	x	18	x	72	171	615.00
RN773	48	x	18	x	72	215	749.00
RN774	60	x	18	x	72	264	995.00
RN775	36	x	24	x	72	215	739.00
RN776	48	x	24	x	72	264	869.00
RN777	60	x	24	x	72	353	1095.00



## HEAVY-DUTY SHELVING

- Modular design allows the unit to be set up as a shelving unit or as work bench
- Includes five Medium-Density Fiberboard (MDF) shelves
- Shelves snap into place quickly and easily
- Kit Type: Starter
- No. of Shelves: 5
- Shelf Capacity: 1200 lbs.
- Material: Steel
- Shelving Unit Type: Boltless
- Style: Open

**KLETON**

Model No.	No. of Shelves	Dimensions					Price /Each
		W"	x	D"	x	H"	
RN806	3	48	x	36	x	84	395.00
RN807	3	48	x	24	x	84	285.00
RN808	3	72	x	24	x	84	345.00
RN809	3	96	x	24	x	84	475.00
RN455	5	36	x	18	x	72	225.00
RN456	5	36	x	24	x	72	245.00
RN457	5	48	x	18	x	72	257.00
RN458	5	48	x	24	x	72	295.00



SEE PAGE 189 FOR

**DURHAM MFG<sup>®</sup>**  
Est. 1922

ROTABIN STORAGE UNITS





# RACKING & SHELVING



## WIDE SPAN RECORD STORAGE SHELVING

- Efficiently organize and store all records in a single information retrieval center
- Record management is facilitated with easy to identify printed storage boxes
- 12-gauge steel posts and beams and warp free particle board decks provides maximum strength
- Easy to install with snap together shelf beams, no nuts and bolts
- Storage boxes constructed of white corrugated fibreboard, with handles, making it a durable and easily maneuverable box, a perfect choice for economical storage
- Order complete units, including shelving, deck and boxes, or shelving with deck only
- Colour: Grey



METALWARE

Model No.	Unit Type	No. of Shelves	W" x D" x H"	Size D" x H"	No. of Boxes	Capacity lbs.	Price /Each
<b>SHELVING &amp; DECK ONLY (WITHOUT BOXES)</b>							
RL997	Starter	3	72 x 18 x 60	18 x 60	-	800	435.00
RL998	Starter	3	72 x 32 x 60	32 x 60	-	800	629.00
RL999	Starter	4	72 x 18 x 84	18 x 84	-	800	570.00
RN001	Starter	4	72 x 32 x 84	32 x 84	-	800	814.00
RN136	Add-on	3	72 x 18 x 60	18 x 60	-	800	362.00
RN137	Add-on	3	72 x 32 x 60	32 x 60	-	800	533.00
RN138	Add-on	4	72 x 18 x 84	18 x 84	-	800	477.00
RN139	Add-on	4	72 x 32 x 84	32 x 84	-	800	698.00
RN002	Starter	3	42 x 18 x 60	18 x 60	-	1340	316.00
RN003	Starter	3	42 x 32 x 60	32 x 60	-	1340	441.00
RN004	Starter	4	42 x 18 x 84	18 x 84	-	1340	411.00
RN005	Starter	4	42 x 32 x 84	32 x 84	-	1340	563.00
RN140	Add-on	3	42 x 18 x 60	18 x 60	-	1340	242.00
RN141	Add-on	3	42 x 32 x 60	32 x 60	-	1340	345.00
RN142	Add-on	4	42 x 18 x 84	18 x 84	-	1340	318.00
RN143	Add-on	4	42 x 32 x 84	32 x 84	-	1340	448.00

## WIDE SPAN RECORD STORAGE SHELVING

- Efficiently organize and store all records in a single information retrieval center
- 12-gauge steel posts and beams and wire mesh decks provide maximum strength
- Easy to install with snap together shelf beams, no nuts and bolts
- Wire mesh decking allows for increased flow and circulation
- Frame Colour: Grey



METALWARE

Model No.	Kit Type	No. of Shelves	Cap lbs. /Shelf	W" x D" x H"	Size D" x H"	Price /Each
RN573	Starter	3	800	72 x 18 x 60	18 x 60	719.00
RN581	Add-On	3	800	72 x 18 x 60	18 x 60	624.00
RN574	Starter	3	800	72 x 32 x 60	32 x 60	903.00
RN582	Add-On	3	800	72 x 32 x 60	32 x 60	780.00
RN575	Starter	4	800	72 x 18 x 84	18 x 84	947.00
RN583	Add-On	4	800	72 x 18 x 84	18 x 84	826.00
RN576	Starter	4	800	72 x 32 x 84	32 x 84	1172.00
RN584	Add-On	4	800	72 x 32 x 84	32 x 84	1025.00

RN009



RN004



Model No.	Unit Type	No. of Shelves	W" x D" x H"	Size D" x H"	No. of Boxes	Capacity lbs.	Price /Each
<b>COMPLETE UNITS (INCLUDES SHELVING, DECK &amp; BOXES)</b>							
RN006	Starter	3	72 x 18 x 60	18 x 60	30	800	702.00
RN007	Starter	3	72 x 32 x 60	32 x 60	60	800	1163.00
RN008	Starter	4	72 x 18 x 84	18 x 84	40	800	926.00
RN009	Starter	4	72 x 32 x 84	32 x 84	80	800	1525.00
RN144	Add-on	3	72 x 18 x 60	18 x 60	30	800	629.00
RN145	Add-on	3	72 x 32 x 60	32 x 60	60	800	1067.00
RN146	Add-on	4	72 x 18 x 84	18 x 84	40	800	833.00
RN147	Add-on	4	72 x 32 x 84	32 x 84	80	800	1410.00
RN010	Starter	3	42 x 18 x 60	18 x 60	18	1340	476.00
RN011	Starter	3	42 x 32 x 60	32 x 60	36	1340	762.00
RN012	Starter	4	42 x 18 x 84	18 x 84	24	1340	624.00
RN013	Starter	4	42 x 32 x 84	32 x 84	48	1340	990.00
RN148	Add-on	3	42 x 18 x 60	18 x 60	18	1340	402.00
RN149	Add-on	3	42 x 32 x 60	32 x 60	36	1340	666.00
RN150	Add-on	4	42 x 18 x 84	18 x 84	24	1340	532.00
RN151	Add-on	4	42 x 32 x 84	32 x 84	48	1340	875.00



RN573

Model No.	Kit Type	No. of Shelves	Cap lbs. /Shelf	W" x D" x H"	Size D" x H"	Price /Each
RN577	Starter	3	1340	42 x 18 x 60	18 x 60	521.00
RN585	Add-On	3	1340	42 x 18 x 60	18 x 60	425.00
RN578	Starter	3	1340	42 x 32 x 60	32 x 60	658.00
RN586	Add-On	3	1340	42 x 32 x 60	32 x 60	534.00
RN579	Starter	4	1340	42 x 18 x 84	18 x 84	680.00
RN587	Add-On	4	1340	42 x 18 x 84	18 x 84	561.00
RN580	Starter	4	1340	42 x 32 x 84	32 x 84	846.00
RN588	Add-On	4	1340	42 x 32 x 84	32 x 84	697.00

## SLOTTED ANGLE SHELVING UNITS

- Cost-effective storage solution
- Shelving is easy to assemble, sturdy and long-lasting
- Ideal for temperature sensitive environments
- Kit Type: Starter
- Material: Galvanized Steel
- Shelving Type: Open
- Assembly required



METALWARE

RN166  
Type 225  
1-1/2 x 2-1/4



RN161  
Type 125  
1-3/8 x 1-3/8

Model No.	No. of Shelves	Shelf Capacity lbs.	Dimensions W" x D" x H"	Price/Each
RN199	6	400	36 x 12 x 72	361.00
RN200	6	400	36 x 15 x 72	382.00
RN201	6	400	36 x 18 x 72	428.00
RN202	6	400	36 x 24 x 72	474.00
RN203	6	300	48 x 12 x 72	405.00
RN204	6	300	48 x 15 x 72	450.00
RN205	6	275	48 x 18 x 72	496.00
RN206	6	275	48 x 24 x 72	610.00
RN207	7	400	36 x 12 x 84	415.00
RN208	7	400	36 x 15 x 84	441.00
RN209	7	400	36 x 18 x 84	495.00
RN210	7	400	36 x 24 x 84	547.00
RN211	7	300	48 x 12 x 84	467.00
RN212	7	300	48 x 15 x 84	521.00
RN213	7	275	48 x 18 x 84	573.00
RN214	7	275	48 x 24 x 84	707.00
RN215	8	400	36 x 12 x 96	469.00
RN216	8	400	36 x 15 x 96	500.00
RN217	8	400	36 x 18 x 96	561.00
RN218	8	400	36 x 24 x 96	622.00
RN219	8	300	48 x 12 x 96	530.00
RN220	8	300	48 x 15 x 96	591.00
RN221	8	275	48 x 18 x 96	651.00
RN222	8	275	48 x 24 x 96	803.00

## SLOTTED ANGLE SHELVES

Model No.	Dimensions D" x W"	Shelf Capacity lbs.	Price/Each
RN152	12 x 36	400	28.60
RN153	15 x 36	400	32.50
RN154	18 x 36	400	39.10
RN155	24 x 36	400	46.10
RN156	32 x 42	300	87.70
RN157	12 x 48	300	36.20
RN158	15 x 48	300	43.40
RN159	18 x 48	275	50.50
RN160	24 x 48	275	66.80

## SLOTTED ANGLE POSTS

- Versatile post can be cut or bolted into workbenches, shelves, or tables
- Can also be used as top tie with Metalware Widespan and Interlock product line
- Angle Gauge: 14

Model No.	Height"	Type	Slotted Angle Dimensions"	Price/Each
RN161	72	125	1-3/8 x 1-3/8	25.00
RN162	84	125	1-3/8 x 1-3/8	30.10
RN163	96	125	1-3/8 x 1-3/8	33.70
RN164	120	125	1-3/8 x 1-3/8	43.80
RN165	144	125	1-3/8 x 1-3/8	51.90
RN166	72	225	1-1/2 x 2-1/4	33.60
RN167	84	225	1-1/2 x 2-1/4	40.40
RN168	96	225	1-1/2 x 2-1/4	44.80
RN169	120	225	1-1/2 x 2-1/4	57.60
RN170	144	225	1-1/2 x 2-1/4	68.80

## SLOTTED ANGLE SIDE BRACES

Model No.	Length"	Price/Each
RN173	33	24.90

## SLOTTED ANGLE BACK BRACES

Model No.	Length"	Price/Each
RN175	51	38.50



RN199



RN207

Steel slotted angle allows you to design and build anything to your own specifications:

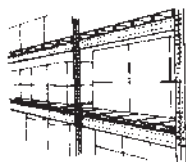

Metal Decking

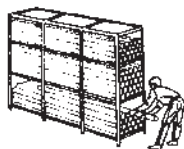

Tubing Storage

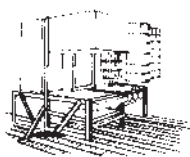

Overhead Storage



Overhead Storage

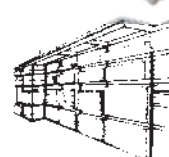

Wide Storage

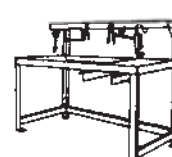

Special Work Benches

# RACKING & SHELVING



## BOLTLESS SHELVING UNITS

- Adjustable shelving system that provides high strength, yet economical storage capacity for your needs
- This system uses an innovative shelf clip, which slips into a slotted "T" post and is immediate ready to receive a shelf
- No-Bolt design reduces up to 80% of installation time
- Colour: Grey
- Ships knocked down



RK550  
"T" Post



RN361  
RN305  
Side and back  
braces

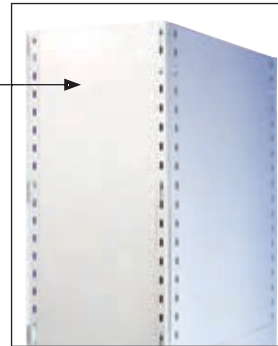

RK521  
End Panels



RK483  
Base Plate

## INTERLOK BOLTLESS SHELVING "T" POST

- For open style shelving includes slots every 1" for shelf or brace installation
- 1 1/2" x 2" x 1/8" double-formed steel in a "T" style with a smooth unperforated face
- Capacity 11000 lbs.

Model No.	Height	Wt. lbs.	Price /Each
RK549	3'4"	4	21.90
RK550	6'4"	8	35.10
RK551	7'4"	9	39.70
RK548	8'4"	10	45.10
RK544	9'4"	11	58.70

## INTERLOK BOLTLESS SHELVING SHELF

- Shelves are easily installed using four clips
- Constructed from 18-gauge steel
- 4 clips included with each shelf

Model No.	Dimensions W" x D"	Capacity lbs.	Wt. lbs.	Price /Each
RN344	36 x 12	630	8	38.00
RN345	42 x 12	480	9	43.80
RN346	48 x 12	315	10.5	53.10
RN347	36 x 15	630	9.75	43.30
RN348	42 x 15	480	11.5	53.10
RN349	48 x 15	315	12.5	60.90
RN350	36 x 18	630	11.5	43.00
RN351	42 x 18	480	13	59.50
RN353	48 x 18	315	15	70.10
RN355	36 x 24	630	14.75	62.70
RN356	42 x 24	480	16.5	73.60
RN358	48 x 24	315	19	87.80
RN359	36 x 30	560	18	85.20

## INTERLOK BOLTLESS SHELVING DOOR

- Lockable swinging doors installs easily on closed style shelving
- Includes RN032 base plate

Model No.	Dimensions W x H	Wt. lbs	Price /Each
RN028	36" x 6'4"	43	814.00
RN029	36" x 7'4"	50	795.00
RN032*	Replacement Base Plate	2	15.60

\*Only for units with doors

## BASE PLATES

- Install at floor level to close openings
- Not compatible when installing doors

Model No.	Dimensions W" x H"	Wt. lbs	Price /Each
RN450	36 x 3	2	15.70
RN452	42 x 3	2.25	19.10
RN454	48 x 3	2.5	20.80



RN344  
Shelves

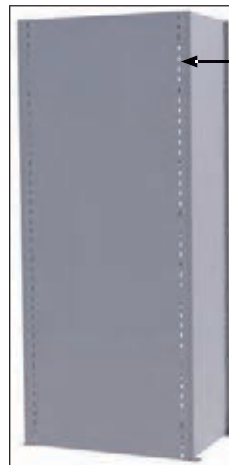

RK470  
Back panel

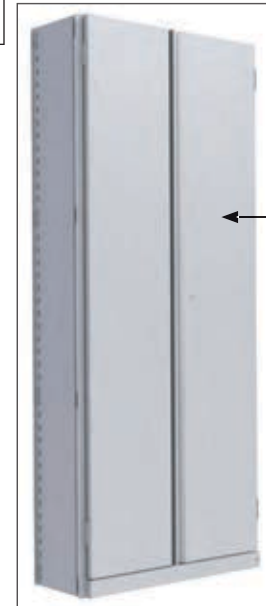

RN028  
Doors

## INTERLOK BOLTLESS SHELVING END PANEL

- For closed style shelving
- Each panel incorporates two slotted post

Model No.	Dimensions D x H	Wt. lbs	Price /Each
RK521	12" x 3'4"	10.5	73.00
RK522	12" x 6'4"	20.75	117.00
RK523	12" x 7'4"	23.5	128.00
RK520	12" x 8'4"	26.25	146.00
RK525	15" x 3'4"	11.5	76.50
RK526	15" x 6'4"	22.5	135.00
RK527	15" x 7'4"	25.5	142.00
RK524	15" x 8'4"	28.5	167.00
RK537	18" x 6'4"	24	138.00
RK538	18" x 7'4"	27	140.00
RK519	18" x 8'4"	30.5	172.00
RK529	24" x 3'4"	14	91.90
RK530	24" x 6'4"	27	162.00
RK531	24" x 7'4"	31	170.00
RK528	24" x 8'4"	34.5	189.00
RK532	30" x 8'4"	38.75	226.00

## INTERLOK BOLTLESS SHELVING BACK PANEL

- For closed style shelving
- Attach easily to end panels using back brackets provided

Model No.	Dimensions W x H	Wt. lbs	Price /Each
RK470	36" x 6'4"	19	126.00
RK471	36" x 7'4"	22	140.00
RK460	36" x 8'4"	25	156.00
RK465	42" x 7'4"	25.5	158.00
RK462	42" x 8'4"	29	179.00
RK947	48" x 3'4"	13.5	65.20
RK468	48" x 6'4"	25.5	156.00
RK469	48" x 7'4"	29.5	175.00
RK466	48" x 8'4"	33.5	196.00

## INTERLOK BOLTLESS SHELVING BRACES

- Provide stability to open style shelving units
- Sold in pairs

Model No.	Description	Wt. lbs	Price /Each
RN305	Back Brace	4	33.20
RN361	Side Brace	2	21.00



## BOLTLESS SHELVING UNITS

- Adjustable shelving system that provides high strength, yet economical storage capacity for your needs
- This system uses an innovative shelf clip, which slips into a slotted "T" post and is immediate ready to receive a shelf
- No-Bolt design reduces up to 80% of installation time
- Colour: Grey
- Ships knocked down



METALWARE

RN328  
Dividers



RL757  
Hanging Bar  
Bracket



RN307  
Bin Front



RN441  
Shelf Boxes



RN340  
Gusset



RN464  
48" Hanger Bar



FM036  
Foot Plate

## INTERLOK BOLTLESS SHELVING DIVIDER

- Separate shelves into bin compartments
- Constructed of 20 gauge steel

Model No.	Dimensions			Wt. lbs	Price /Each
	D"	x	H"		
RN328	12	x	6	0.5	12.30
RN329	15	x	6	0.75	12.60
RN330	18	x	6	1	13.00
RN331	24	x	6	1.5	15.30
RN332	12	x	8	0.75	13.10
RN333	15	x	8	1	13.70
RN334	18	x	8	1.5	14.60
RN335	24	x	8	2	18.90
RN313	12	x	10	1	14.40
RN314	15	x	10	1.25	15.40
RN315	18	x	10	1.75	17.10
RN316	24	x	10	2.25	20.60
RN317	12	x	12	1.25	15.80
RN318	15	x	12	1.75	17.10
RN319	18	x	12	2	19.60
RN320	24	x	12	2.75	24.00
RN321	12	x	14	1.5	17.10
RN322	15	x	14	2	19.30
RN323	18	x	14	2.25	20.60
RN324	24	x	14	3.25	26.70
RN325	18	x	16	2.5	28.20
RN326	18	x	18	2.75	33.40

## INTERLOK BOLTLESS SHELVING SHELF BOX

- Slide onto properly spaced shelving
- Extends 100% without spills
- Constructed of 20 gauge steel

Model No.	Dimensions				Wt. lbs	Price /Each
	W"	x	D"	x H"		
RN441	5 5/8	x	12	x 2 3/4	2.5	45.50
RN443	5 5/8	x	18	x 2 3/4	3.5	59.00
RN447	5 5/8	x	12	x 4 3/4	3.5	47.30
RN448	5 5/8	x	15	x 4 3/4	4	57.80
RN462	5 5/8	x	18	x 4 3/4	4.5	59.40
RN445	11	x	18	x 4 3/4	5	117.00
RN444	12	x	12	x 4 3/4	5.5	103.00

## MISCELLANEOUS

Model No.	Description	Wt. lbs	Price /Each
FM036	Interlok Boltless Shelving Foot Plate	0.3	8.07
RN340	Interlok Boltless Shelving Gussets	1	13.80
RL464*	Interlok Boltless Shelving Hanging Bar	3.5	102.00
RL757	Interlok Boltless Shelving Hanging Bar Bracket	0.05	29.30
RC515	Interlok Boltless Shelving Shelf Clip	0.01	0.88
RN306	Interlok Boltless Shelving Back-to-Back Brackets	0.01	2.44
RC383	Interlok Boltless Shelving Back Panel Brackets	-	1.80

\*Requires two brackets (RL757)

## INTERLOK BOLTLESS SHELVING BIN FRONT/BASE PLATE

- Used in conjunction with bin dividers

Model No.	Dimensions			Wt. lbs	Price /Each
	W"	x	H"		
RN307	36	x	1	1.75	17.40
RN309	36	x	2	2	18.90
RN450	36	x	3	2.25	15.70
RN308	42	x	1	2	19.30
RN310	42	x	2	2.25	21.30
RN452	42	x	3	2.5	19.10

# RACKING & SHELVING



## INTERLOK SHELVING UNITS

- Adjustable shelving system that provides high strength, yet economical storage capacity for your needs
- This system uses an innovative shelf clip, which slips into a slotted "T" post and is immediate ready to receive a shelf
- No-Bolt design reduces up to 80% of installation time
- Colour: Grey
- Ships knocked down



METALWARE

36" W X 6'4" H



4 SHELVES

Starter Unit	Depth"	Price /Each
RK205	12	389.00
RK207	18	434.00
RK209	24	490.00

Add-On Unit	Depth"	Price /Each
RK204	12	290.00
RK206	18	333.00
RK208	24	391.00

36" W X 6'4" H



7 SHELVES

Starter Unit	Depth"	Price /Each
RK217	12	507.00
RK219	18	583.00
RK221	24	685.00

Add-On Unit	Depth"	Price /Each
RK216	12	404.00
RK218	18	480.00
RK220	24	583.00

36" W X 6'4" H



10 SHELVES

Starter Unit	Depth"	Price /Each
RK229	12	623.00
RK231	18	728.00
RK233	24	875.00

Add-On Unit	Depth"	Price /Each
RK228	12	520.00
RK230	18	629.00
RK232	24	775.00

36" W X 6'4" H



13 SHELVES

Starter Unit	Depth"	Price /Each
RK241	12	738.00
RK243	18	878.00
RK245	24	1067.00

Add-On Unit	Depth"	Price /Each
RK240	12	635.00
RK242	18	778.00
RK244	24	966.00

36" W X 7'4" H



4 SHELVES

Starter Unit	Depth"	Price /Each
RK309	12	410.00
RK311	18	452.00
RK313	24	510.00

Add-On Unit	Depth"	Price /Each
RK308	12	297.00
RK310	18	341.00
RK312	24	400.00

36" W X 7'4" H



7 SHELVES

Starter Unit	Depth"	Price /Each
RK333	12	526.00
RK335	18	601.00
RK337	24	701.00

Add-On Unit	Depth"	Price /Each
RK332	12	414.00
RK334	18	490.00
RK336	24	590.00

36" W X 7'4" H



8 SHELVES

Starter Unit	Depth"	Price /Each
RK321	12	563.00
RK323	18	650.00
RK325	24	767.00

Add-On Unit	Depth"	Price /Each
RK320	12	452.00
RK322	18	539.00
RK324	24	657.00

36" W X 7'4" H



15 SHELVES

Starter Unit	Depth"	Price /Each
RK345	12	833.00
RK347	18	998.00
RK349	24	1213.00

Add-On Unit	Depth"	Price /Each
RK344	12	721.00
RK346	18	887.00
RK348	24	1104.00

48" W X 7'4" H



4 SHELVES

Starter Unit	Depth"	Price /Each
RK285	12	474.00
RK287	18	541.00
RK289	24	614.00

Add-On Unit	Depth"	Price /Each
RK284	12	363.00
RK286	18	431.00
RK288	24	504.00

48" W X 7'4" H



7 SHELVES

Starter Unit	Depth"	Price /Each
RK297	12	635.00
RK299	18	756.00
RK301	24	885.00

Add-On Unit	Depth"	Price /Each
RK296	12	524.00
RK298	18	646.00
RK300	24	774.00

36" W X 8'4" H



5 SHELVES

Starter Unit	Depth"	Price /Each
RK425	12	478.00
RK427	18	531.00
RK429	24	605.00

Add-On Unit	Depth"	Price /Each
RK424	12	351.00
RK426	18	405.00
RK428	24	479.00

36" W X 8'4" H



9 SHELVES

Starter Unit	Depth"	Price /Each
RK401	12	630.00
RK403	18	727.00
RK405	24	859.00

Add-On Unit	Depth"	Price /Each
RK400	12	507.00
RK402	18	602.00
RK404	24	734.00

## INTERLOK SHELVING UNITS

- Adjustable shelving system that provides high strength, yet economical storage capacity for your needs
- This system uses an innovative shelf clip, which slips into a slotted "T" post and is immediate ready to receive a shelf
- No-Bolt design reduces up to 80% of installation time
- Colour: Grey
- Ships knocked down



METALWARE

36" W X 6'4" H



4 SHELVES

Starter Unit	Depth"	Price /Each
RK211	12	542.00
RK213	18	632.00
RK215	24	736.00

Add-On Unit	Depth"	Price /Each
RK210	12	420.00
RK212	18	486.00
RK214	24	567.00

36" W X 6'4" H



7 SHELVES

Starter Unit	Depth"	Price /Each
RK223	12	660.00
RK225	18	780.00
RK227	24	926.00

Add-On Unit	Depth"	Price /Each
RK222	12	537.00
RK224	18	635.00
RK226	24	757.00

36" W X 6'4" H



10 SHELVES

Starter Unit	Depth"	Price /Each
RK235	12	776.00
RK237	18	930.00
RK239	24	1120.00

Add-On Unit	Depth"	Price /Each
RK234	12	650.00
RK236	18	781.00
RK238	24	950.00

36" W X 7'4" H



4 SHELVES

Starter Unit	Depth"	Price /Each
RK315	12	583.00
RK317	18	664.00
RK319	24	768.00

Add-On Unit	Depth"	Price /Each
RK314	12	447.00
RK316	18	509.00
RK318	24	590.00

36" W X 7'4" H



7 SHELVES

Starter Unit	Depth"	Price /Each
RK339	12	697.00
RK341	18	811.00
RK343	24	961.00

Add-On Unit	Depth"	Price /Each
RK338	12	563.00
RK340	18	658.00
RK342	24	781.00

36" W X 7'4" H



8 SHELVES

Starter Unit	Depth"	Price /Each
RK327	12	737.00
RK329	18	860.00
RK331	24	1024.00

Add-On Unit	Depth"	Price /Each
RK326	12	601.00
RK328	18	707.00
RK330	24	847.00

36" W X 7'4" H



15 SHELVES

Starter Unit	Depth"	Price /Each
RK351	12	1006.00
RK353	18	1205.00
RK355	24	1472.00

Add-On Unit	Depth"	Price /Each
RK350	12	870.00
RK352	18	1054.00
RK354	24	1295.00

48" W X 7'4" H



4 SHELVES

Starter Unit	Depth"	Price /Each
RK291	12	686.00
RK293	18	792.00
RK295	24	910.00

Add-On Unit	Depth"	Price /Each
RK290	12	549.00
RK292	18	639.00
RK294	24	735.00

48" W X 7'4" H



7 SHELVES

Starter Unit	Depth"	Price /Each
RK303	12	846.00
RK305	18	1006.00
RK307	24	1182.00

Add-On Unit	Depth"	Price /Each
RK302	12	710.00
RK304	18	855.00
RK306	24	1004.00

36" W X 8'4" H



5 SHELVES

Starter Unit	Depth"	Price /Each
RK431	12	662.00
RK433	18	773.00
RK435	24	891.00

Add-On Unit	Depth"	Price /Each
RK430	12	511.00
RK432	18	596.00
RK434	24	690.00

36" W X 8'4" H



9 SHELVES

Starter Unit	Depth"	Price /Each
RK407	12	816.00
RK409	18	970.00
RK411	24	1149.00

Add-On Unit	Depth"	Price /Each
RK406	12	668.00
RK408	18	792.00
RK410	24	947.00

36" W X 8'4" H



13 SHELVES

Starter Unit	Depth"	Price /Each
RK419	12	970.00
RK421	18	1169.00
RK423	24	1403.00

Add-On Unit	Depth"	Price /Each
RK418	12	821.00
RK420	18	991.00
RK422	24	1201.00



# RACKING & SHELVING



## INTERLOK SHELVING UNITS

- Adjustable shelving system that provides high strength, yet economical storage capacity for your needs
- This system uses an innovative shelf clip, which slips into a slotted "T" post and is immediate ready to receive a shelf
- No-Bolt design reduces up to 80% of installation time
- Colour: Grey
- Ships knocked down



METALWARE

36" W X 6'4" H



4 SHELVES W/DOORS

Starter Unit	Depth"	Price /Each
RK849	12	1422.00
RK850	18	1509.00
RK851	24	1613.00

Add-On Unit	Depth"	Price /Each
RK852	12	1297.00
RK853	18	1363.00
RK854	24	1444.00

36" W X 7'4" H



4 SHELVES W/ DOORS

Starter Unit	Depth"	Price /Each
RK893	12	1473.00
RK894	18	1554.00
RK895	24	1661.00

Add-On Unit	Depth"	Price /Each
RK896	12	1341.00
RK897	18	1403.00
RK898	24	1486.00

36" W X 6'4" H



7 SHELVES W/DOORS

Starter Unit	Depth"	Price /Each
RK855	12	1535.00
RK856	18	1657.00
RK857	24	1804.00

Add-On Unit	Depth"	Price /Each
RK858	12	1413.00
RL013	18	1510.00
RL015	24	1640.00

36" W X 7'4" H



7 SHELVES W/DOORS

Starter Unit	Depth"	Price /Each
RK899	12	1592.00
RK900	18	1704.00
RK989	24	1852.00

Add-On Unit	Depth"	Price /Each
RK902	12	1455.00
RK903	18	1550.00
RK904	24	1676.00

36" W X 7'4" H



10 COMPARTMENTS W/DOORS

Starter Unit	Depth"	Price /Each
RK911	12	1615.00
RK912	18	1719.00
RK913	24	1871.00

Add-On Unit	Depth"	Price /Each
RK914	12	1478.00
RK915	18	1565.00
RK916	24	1693.00

36" W X 7'4" H



21 COMPARTMENTS W/DOORS

Starter Unit	Depth"	Price /Each
RK921	12	1851.00
RK922	18	2033.00
RK923	24	2258.00

Add-On Unit	Depth"	Price /Each
RK924	12	1719.00
RK925	18	1878.00
RK926	24	2080.00

36" W X 6'4" H



14 COMPARTMENTS

Starter Unit	Depth"	Price /Each
RK259	12	788.00
RK261	18	938.00
RK263	24	1122.00

Add-On Unit	Depth"	Price /Each
RK258	12	664.00
RK260	18	792.00
RK262	24	952.00

36" W X 6'4" H



18 COMPARTMENTS

Starter Unit	Depth"	Price /Each
RK265	12	852.00
RK267	18	1019.00
RK269	24	1219.00

Add-On Unit	Depth"	Price /Each
RK264	12	727.00
RK266	18	873.00
RK268	24	1050.00

36" W X 6'4" H



72 COMPARTMENTS W/BIN FRONTS

Starter Unit	Depth"	Price /Each
RK271	12	1841.00
RK273	18	2067.00
RK275	24	2437.00

Add-On Unit	Depth"	Price /Each
RK270	12	1717.00
RK272	18	1922.00
RK274	24	2267.00

36" W X 7'4" H



14 COMPARTMENTS

Starter Unit	Depth"	Price /Each
RK363	12	834.00
RK365	18	979.00
RK367	24	1175.00

Add-On Unit	Depth"	Price /Each
RK362	12	704.00
RK364	18	825.00
RK366	24	999.00

36" W X 7'4" H



21 COMPARTMENTS

Starter Unit	Depth"	Price /Each
RK369	12	958.00
RK371	18	1136.00
RK373	24	1363.00

Add-On Unit	Depth"	Price /Each
RK368	12	823.00
RK370	18	984.00
RK372	24	1188.00

36" W X 7'4" H



84 COMPARTMENTS

Starter Unit	Depth"	Price /Each
RK905	12	1876.00
RK906	18	2128.00
RK907	24	2550.00

Add-On Unit	Depth"	Price /Each
RK908	12	1743.00
RK909	18	1975.00
RK910	24	2372.00

## INTERLOK INTEGRATED MODULAR DRAWER SYSTEMS

### FOR METALWARE SHELVING

- Full-height drawer sides & face front
- Non-slip ergonomic handle design for easy grip and secure hold
- Fully compatible and adjustable with all Interlok units
- Complete extension with sliding pull-out and push-back for easy viewing and accessibility
- Self-close with 450 lbs. capacity per drawer
- Drawer unit is framed within the Interlok shelf using adaptor brackets for added security and unparalleled strength
- The boxed drawer sides and Delrin Roller rail-system increases coverage and support of goods
- The powder-coated finish adds to the streamlined and functional design
- Inside drawer height is 1" less than listed drawer height

**COMPATIBLE**  
Fully compatible and adjustable with all Interlok units

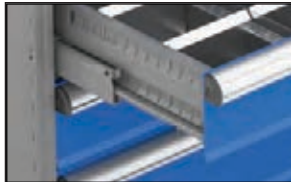
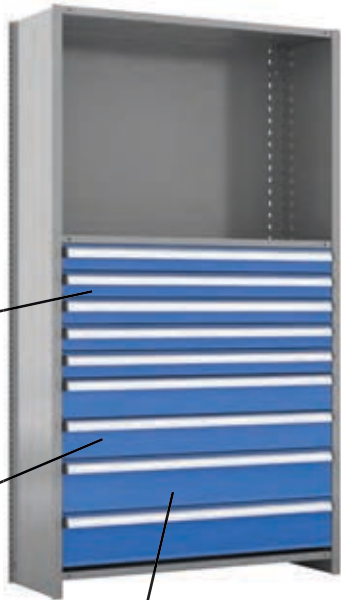

**FULL-HEIGHT DRAWER SIDES & FACE FRONT**  
Feel confident that your wares are stored exactly where they need to be



**ERGONOMIC DESIGN**  
Non-slip ergonomic handle design for easy grip and secure hold



**DROP-IN DIVIDERS**  
Each drawer includes drop-in dividers offered in a variety of configurations to compartmentalize and maximize your storage needs

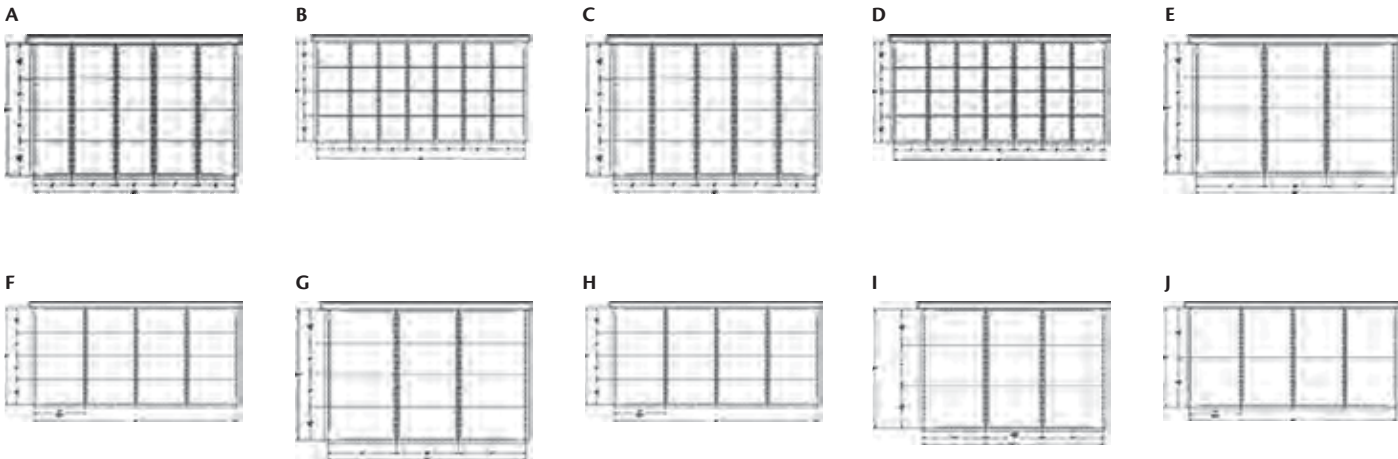

OVERALL HEIGHT: 18"



#### 3 DRAWERS

Model No.	Dim. D" x W"	No. of Compartments	Contains	Price /Each
RN736	24 x 36	41	(1) C, (1) G, (1) I	1234.00
RN743	24 x 48	52	(1) D, (1) H, (1) J	1537.00



#### 4 DRAWERS

Model No.	Dim. D" x W"	No. of Compartments	Contains	Price /Each
RN737	24 x 36	64	(1) A, (1) C, (1) E, (1) G	1517.00
RN744	24 x 48	88	(1) B, (1) D, (1) F, (1) H	1889.00



#### 5 DRAWERS

Model No.	Dim. D" x W"	No. of Compartments	Contains	Price /Each
RN738	24 x 36	100	(2) A, (3) C	1830.00
RN745	24 x 48	140	(2) B, (3) D	2301.00

# RACKING & SHELVING

## INTERLOK INTEGRATED MODULAR DRAWER SYSTEMS (CONT'D)

OVERALL HEIGHT: 24"



4 DRAWERS

Model No.	Dim. D" x W"	No. of Compartments	Contains	Price /Each
RN739	24 x 36	48	(4) G	1577.00
RN747	24 x 48	64	(4) H	1962.00



5 DRAWERS

Model No.	Dim. D" x W"	No. of Compartments	Contains	Price /Each
RN740	24 x 36	68	(1) C, (1) E	1831.00
RN746	24 x 48	92	(1) D, (4) F	2280.00



**METALWARE**

REFER TO PAGE 167  
FOR LINE DRAWINGS



6 DRAWERS

Model No.	Dim. D" x W"	No. of Compartments	Contains	Price /Each
RN741	24 x 36	104	(2) A, (2) C, (2) E	2151.00
RN748	24 x 48	144	(2) B, (2) D, (2) F	2720.00



7 DRAWERS

Model No.	Dim. D" x W"	No. of Compartments	Contains	Price /Each
RN742	24 x 36	140	(4) A, (3) C	2474.00
RN749	24 x 48	196	(4) B, (3) D	3127.00

OVERALL HEIGHT: 36"



6 DRAWERS

Model No.	Dim. D" x W"	No. of Compartments	Contains	Price /Each
RN750	24 x 36	74	(1) C, (2) E, (1) G, (2) I	2252.00
RN757	24 x 48	92	(1) D, (2) F, (1) H, (2) J	2843.00



8 DRAWERS

Model No.	Dim. D" x W"	No. of Compartments	Contains	Price /Each
RN751	24 x 36	128	(4) C, (4) E	2832.00
RN758	24 x 48	176	(4) D, (4) F	3567.00



10 DRAWERS

Model No.	Dim. D" x W"	No. of Compartments	Contains	Price /Each
RN752	24 x 36	200	(4) A, (6) C	3473.00
RN759	24 x 48	280	(4) B, (6) D	4415.00

OVERALL HEIGHT: 48"



7 DRAWERS

Model No.	Dim. D" x W"	No. of Compartments	Contains	Price /Each
RN753	24 x 36	84	(4) G, (1) I	2666.00
RN760	24 x 48	88	(4) H, 3 (J)	3386.00



8 DRAWERS

Model No.	Dim. D" x W"	No. of Compartments	Contains	Price /Each
RN754	24 x 36	96	(8) G	2964.00
RN761	24 x 48	128	(8) H	3733.00



11 DRAWERS

Model No.	Dim. D" x W"	No. of Compartments	Contains	Price /Each
RN755	24 x 36	188	(7) C, (4) E	3827.00
RN762	24 x 48	260	(7) D, (4) F	4853.00



14 DRAWERS

Model No.	Dim. D" x W"	No. of Compartments	Contains	Price /Each
RN756	24 x 36	280	(8) A, (6) C	4755.00
RN763	24 x 48	392	(8) B, (6) D	6064.00





# ORGANIZE ANY INDUSTRIAL & COMMERCIAL STORAGE AREA WITH

# KLETON

## WIRE SHELVING SYSTEMS



**Heavy-Duty**  
2000-lb. Capacity



**Green Epoxy Finish**



**Basket Shelf Carts**

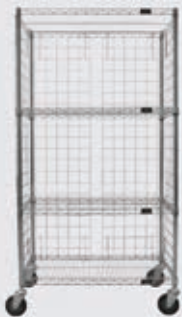

**Enclosed Stock Carts**



**Push Carts**



**Slanted Shelving Units**



**Utility Carts**



**Standard-Duty**  
1000-lb. Capacity



**Shelf Carts**

# WIRE SHELVING

## HEAVY-DUTY CHROMATE WIRE SHELVING

- Heavy-gauge chromate plated shelves with open wire design minimize dust, improve air circulation and provide greater visibility of stored items
- Post's circular grooves combined with tapered plastic split sleeves allow for assembly in minutes with no special tools
- Shelf ribs run front to back allowing items to slide on and off shelves smoothly
- Shelves can be adjusted at precise 1" intervals
- Posts are double grooved every 8" and numbered for easy adjustment
- Adjustable feet compensate for surface irregularities
- Stationary unit's total capacity should not exceed 2000 lbs.
- NSF certified
- Assembly required

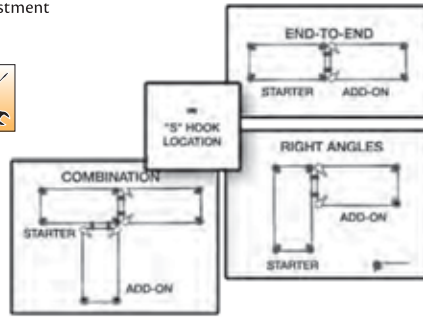

**Kleton wire shelving can be assembled as you wish: End to End, at Right Angles or any combination.**

### 3 SHELVES

Model No.	Type	Dimensions W" x D" x H"	Cap. lbs /Shelf*	Wt. lbs.	Price /Each
<b>33" POSTS</b>					
RN835	Starter	30 x 14 x 33	800	-	129.00
RN836	Add-On	30 x 14 x 33	800	-	109.00
RN837	Starter	36 x 14 x 33	800	-	139.00
RN838	Add-On	36 x 14 x 33	800	-	125.00
RN839	Starter	48 x 14 x 33	800	-	159.00
RN840	Add-On	48 x 14 x 33	800	-	145.00
RN841	Starter	30 x 18 x 33	800	-	145.00
RN842	Add-On	30 x 18 x 33	800	-	135.00
RN843	Starter	36 x 18 x 33	800	-	159.00
RN844	Add-On	36 x 18 x 33	800	-	135.00
RN846	Add-On	48 x 18 x 33	800	-	162.00
RN847	Starter	60 x 18 x 33	800	-	209.00
RN848	Add-On	60 x 18 x 33	800	-	189.00
RN849	Starter	72 x 18 x 33	800	-	249.00
RN850	Add-On	72 x 18 x 33	800	-	225.00
RN851	Starter	36 x 24 x 33	800	-	175.00
RN852	Add-On	36 x 24 x 33	800	-	158.00
RN853	Starter	48 x 24 x 33	800	-	215.00
RN854	Add-On	48 x 24 x 33	800	-	199.00
RN855	Starter	60 x 24 x 33	800	-	265.00
RN856	Add-On	60 x 24 x 33	800	-	249.00
RN857	Starter	72 x 24 x 33	800	-	299.00
RN858	Add-On	72 x 24 x 33	800	-	299.00

\* Evenly distributed

### 4 SHELVES

Model No.	Type	Dimensions W" x D" x H"	Cap. lbs /Shelf*	Wt. lbs.	Price /Each
<b>54" POSTS</b>					
RN811	Starter	30 x 14 x 54	800	-	183.00
RN812	Add-On	30 x 14 x 54	800	-	149.00
RN813	Starter	36 x 14 x 54	800	-	192.00
RN814	Add-On	36 x 14 x 54	800	-	159.00
RN815	Starter	48 x 14 x 54	800	-	209.00
RN816	Add-On	48 x 14 x 54	800	-	179.00
RN817	Starter	30 x 18 x 54	800	-	199.00
RN818	Add-On	30 x 18 x 54	800	-	168.00
RN819	Starter	36 x 18 x 54	800	-	205.00
RN820	Add-On	36 x 18 x 54	800	-	174.00
RN822	Add-On	48 x 18 x 54	800	-	219.00
RN823	Starter	60 x 18 x 54	800	-	288.00
RN824	Add-On	60 x 18 x 54	800	-	257.00
RN825	Starter	72 x 18 x 54	800	-	335.00
RN826	Add-On	72 x 18 x 54	800	-	299.00
RN827	Starter	36 x 24 x 54	800	-	225.00
RN828	Add-On	36 x 24 x 54	800	-	209.00
RN829	Starter	48 x 24 x 54	800	-	289.00
RN830	Add-On	48 x 24 x 54	800	-	265.00
RN831	Starter	60 x 24 x 54	800	-	345.00
RN832	Add-On	60 x 24 x 54	800	-	325.00
RN833	Starter	72 x 24 x 54	800	-	418.00
RN834	Add-On	72 x 24 x 54	800	-	385.00
<b>63" POSTS</b>					
RL907	Starter	30 x 14 x 63	800	39	219.00
RL908	Add-On	30 x 14 x 63	800	32	184.00
RL632	Starter	36 x 14 x 63	800	43	227.00
RL633	Add-on	36 x 14 x 63	800	35.5	189.00
RL634	Starter	48 x 14 x 63	800	49	249.00
RL635	Add-on	48 x 14 x 63	800	42	215.00
RL636	Starter	60 x 14 x 63	600	64.75	277.00
RL637	Add-on	60 x 14 x 63	600	57.75	248.00
RL638	Starter	72 x 14 x 63	600	71.5	299.00
RL639	Add-on	72 x 14 x 63	600	64	274.00
RL059	Starter	36 x 18 x 63	800	48	247.00
RL060	Add-on	36 x 18 x 63	800	35	219.00
RL061	Starter	48 x 18 x 63	800	58	279.00
RL062	Add-on	48 x 18 x 63	800	53.5	257.00
RL063	Starter	60 x 18 x 63	600	81	336.00
RL064	Add-on	60 x 18 x 63	600	76.5	299.00
RL065	Starter	72 x 18 x 63	600	91	389.00
RL066	Add-on	72 x 18 x 63	600	86.5	354.00
RL067	Starter	36 x 24 x 63	800	62	296.00
RL068	Add-on	36 x 24 x 63	800	57.5	269.00
RL069	Starter	48 x 24 x 63	800	74	335.00
RL070	Add-on	48 x 24 x 63	800	69.5	309.00
RL071	Starter	60 x 24 x 63	600	95	389.00
RL072	Add-on	60 x 24 x 63	600	90.5	354.00
RL073	Starter	72 x 24 x 63	600	117	478.00
RL074	Add-on	72 x 24 x 63	600	112.5	439.00

\* Evenly distributed

### 5 SHELVES

Model No.	Type	Dimensions W" x D" x H"	Cap. lbs /Shelf*	Wt. lbs.	Price /Each
<b>74" POSTS</b>					
RL909	Starter	30 x 14 x 74	800	46.5	248.00
RL910	Add-On	30 x 14 x 74	800	39	207.00
RL640	Starter	36 x 14 x 74	800	51	258.00
RL641	Add-on	36 x 14 x 74	800	44	227.00
RL642	Starter	48 x 14 x 74	800	59	288.00
RL643	Add-on	48 x 14 x 74	800	42.8	274.00
RL644	Starter	60 x 14 x 74	600	78.75	337.00
RL645	Add-on	60 x 14 x 74	600	71	313.00
RL646	Starter	72 x 14 x 74	600	87	374.00
RL647	Add-on	72 x 14 x 74	600	79.5	346.00
RL075	Starter	36 x 18 x 74	800	67.75	297.00
RL076	Add-on	36 x 18 x 74	800	58.25	269.00
RL077	Starter	48 x 18 x 74	800	80.25	346.00
RL078	Add-on	48 x 18 x 74	800	70.75	319.00
RL079	Starter	60 x 18 x 74	600	109	389.00
RL080	Add-on	60 x 18 x 74	600	99.5	364.00
RL081	Starter	72 x 18 x 74	600	121.5	449.00
RL082	Add-on	72 x 18 x 74	600	112	419.00
RL083	Starter	36 x 24 x 74	800	85.25	359.00
RL084	Add-on	36 x 24 x 74	800	75.75	329.00
RL085	Starter	48 x 24 x 74	800	100.25	409.00
RL086	Add-on	48 x 24 x 74	800	90.75	378.00
RL087	Starter	60 x 24 x 74	600	126.5	464.00
RL088	Add-on	60 x 24 x 74	600	117	436.00
RL089	Starter	72 x 24 x 74	600	154	539.00
RL090	Add-on	72 x 24 x 74	600	144.5	513.00
<b>86" POSTS</b>					
RL448	Starter	36 x 18 x 86	800	62	319.00
RL449	Add-on	36 x 18 x 86	800	53	283.00
RL450	Starter	48 x 18 x 86	800	69	359.00
RL451	Add-on	48 x 18 x 86	800	60	329.00
RL452	Starter	60 x 18 x 86	600	91.5	409.00
RL453	Add-on	60 x 18 x 86	600	82	373.00
RL454	Starter	72 x 18 x 86	600	96	468.00
RL455	Add-on	72 x 18 x 86	600	87	429.00
RL456	Starter	36 x 24 x 86	800	74	378.00
RL457	Add-on	36 x 24 x 86	800	65	339.00
RL458	Starter	48 x 24 x 86	800	90	428.00
RL459	Add-on	48 x 24 x 86	800	80	389.00
RL460	Starter	60 x 24 x 86	600	107	479.00
RL461	Add-on	60 x 24 x 86	600	97	449.00
RL462	Starter	72 x 24 x 86	600	129	558.00
RL463	Add-on	72 x 24 x 86	600	120	519.00

\* Evenly distributed



## HEAVY-DUTY WIRE SHELVING COMPONENTS

- Heavy-gauge chromate plated shelves with open wire design minimize dust, improve air circulation and provide greater visibility of stored items
- Post's circular grooves combined with tapered plastic split sleeves allow for assembly in minutes with no special tools
- Shelf ribs run front to back allowing items to slide on and off shelves smoothly
- Shelves can be adjusted at precise 1" intervals
- Posts are double grooved every 8" and numbered for easy adjustment
- Adjustable feet compensate for surface irregularities
- Stationary unit's total capacity should not exceed 2000 lbs.
- NSF certified
- Assembly required

### WIRE SHELVES

Model No.	Dimensions W" x D"	Cap lbs.*	Wt. lbs.	Price /Each
RL606	30 x 14	800	7.5	39.55
RL607	36 x 14	800	8.25	41.50
RL608	48 x 14	800	10.5	49.50
RL609	60 x 14	600	14.25	55.95
RL610	72 x 14	600	17.5	64.95
RL035	30 x 18	800	8.5	42.70
RL036	36 x 18	800	9.75	46.80
RL037	48 x 18	800	12.5	60.85
RL038	60 x 18	600	18	75.95
RL039	72 x 18	600	20.5	87.90
RL040	36 x 24	800	13.25	55.95
RL041	48 x 24	800	16.25	75.45
RL042	60 x 24	600	21.5	88.95
RL043	72 x 24	600	27	105.00

\* Evenly distributed weight

### POSTS

Model No.	Height"	Wt. lbs.	Price /Each
RL611	33	4	14.70
RL330	54	6.3	17.90
RL331	63	7	20.95
RL332	74	8	23.95
RL333	86	8.8	26.50



# KLETON

## ACCESSORIES



RL048

RL049



RL050 Divider



RL054 Split Sleeve



RL055 "S" Hook

Use S hooks to eliminate two posts per adjacent shelf. Two required per shelf.



RL056 Leveling Foot

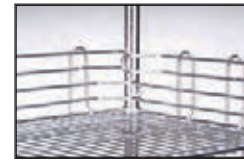

RL614 Ledge for Shelf



RL330 Posts

Model No.	Description	Wt. lbs.	Price /Each
RL048	Caster, 5", no brake	2.8	27.50
RL049	Caster, 5", with brake	2.7	28.95
RL050	Divider for shelf, 18"	1.7	18.95
RL051	Divider for shelf, 24"	2.2	22.75
RL052	Handle 18" - For utility carts	3.9	36.95
RL053	Handle 24" - For utility carts	4.4	37.95

Model No.	Description	Wt. lbs.	Price /Each
RL054	Split Sleeves, black 4 Pc/bag	0.1	5.35
RL055	S-Hook for attaching Add-On	0.1	4.50
RL056	Leveling feet (Die cast and foot bolt)	0.2	4.15
RL057	Die cast for leveling feet	0.1	2.25
RL058	Foot bolt for leveling feet	0.1	2.35

Model No.	Description	Wt. lbs.	Price /Each
RL614	Ledge for shelf, 14"	0.6	12.85
RL615	Ledge for shelf, 18"	0.75	13.60
RL616	Ledge for shelf, 24"	1	15.90
RL617	Ledge for shelf, 30"	2	19.25
RL618	Ledge for shelf, 36"	2.5	21.00
RL619	Ledge for shelf, 48"	3.5	25.15
RL620	Ledge for shelf, 60"	3.75	26.60
RL621	Ledge for shelf, 72"	4	33.70

## DIRECT WALL MOUNTS FOR WIRE SHELVING

SAME GREAT FEATURES AS THE KLETON CHROMATE WIRE SHELVING, BUT WITH THE ADDED CONVENIENCE OF DIRECTLY MOUNTING ON A WALL

- Each wall mount unit consists of one shelf support and mounting plate
- Use single support at shelf ends; double support for adjoining shelves
- Installation note: Wall mounts must be securely fastened to materials of adequate load bearing strength. (Load rating: 200 lbs. (91kg) per system)
- NSF certified



RL612  
Single Shelf Support



RL613  
Double Shelf Support

# KLETON

Model No.	Shelf Support	Shelf Depth"	Price /Each
RL612	Single	14	38.55
RL898	Single	18	45.00
RL900	Single	24	46.90
RL613	Double	14	57.95
RL899	Double	18	68.80
RL901	Double	24	70.25

## WALL MOUNT WIRE SHELVING KITS

- Kit includes shelves and supports
- NSF certified



RL911  
Shelf and Support Kit

# KLETON

Model No.	Description	Shelf Dimensions"	Price /Each
RL911	1 Shelf	30 x 14	105.00
RL912	2 Shelves	30 x 14	194.00



# WIRE SHELVING

## HEAVY-DUTY WIRE SHELVING UNITS WITH STORAGE BINS

Same great features as the Kleton chromate wire shelving, but with the added convenience of heavy-duty storage bins.

- Adjustable chromate wire shelves
- Wire shelving resists corrosion and provides greater visibility to stored parts
- Wire shelves prevent build up of dust and dirt
- Bins are unaffected by oil, alkaline, and most acids
- Ideal in production or for parts storage
- Assembly required
- NSF certified
- Unit's total capacity should not exceed 2000-lb.

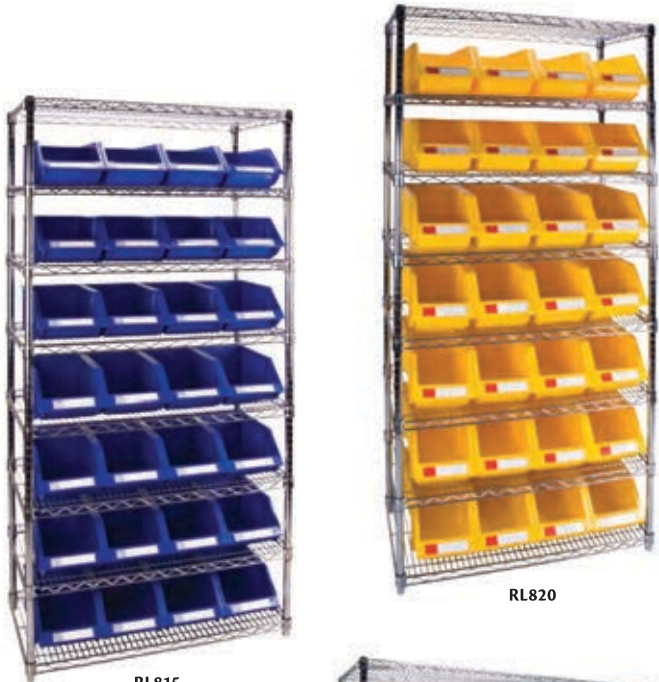

RL815

RL820



RL826



RL837

Model No.	Shelving Size			No. of Shelves	Bin Size			No. of Bins	Colour	Price /Each
	W" x D" x H"	W"	D"		W"	D"	H"			
RL815	36 x 14 x 74	8	83/16 x 14 x 63/16	8	83/16	x 14	x 63/16	28	Blue	730.00
RL816	36 x 14 x 74	8	83/16 x 14 x 63/16	8	83/16	x 14	x 63/16	28	Yellow	730.00
RL817	36 x 14 x 74	8	83/16 x 14 x 63/16	8	83/16	x 14	x 63/16	28	Green	730.00
RL818	36 x 14 x 74	8	83/16 x 14 x 63/16	8	83/16	x 14	x 63/16	28	Red	730.00
RL819	36 x 18 x 74	8	77/8 x 17 11/16 x 7	8	77/8	x 17 11/16	x 7	28	Blue	999.00
RL820	36 x 18 x 74	8	77/8 x 17 11/16 x 7	8	77/8	x 17 11/16	x 7	28	Yellow	999.00
RL821	36 x 18 x 74	8	77/8 x 17 11/16 x 7	8	77/8	x 17 11/16	x 7	28	Green	999.00
RL822	36 x 18 x 74	8	77/8 x 17 11/16 x 7	8	77/8	x 17 11/16	x 7	28	Red	999.00
RL823	36 x 24 x 74	5	15 1/2 x 25 x 13	5	15 1/2	x 25	x 13	8	Blue	800.00
RL824	36 x 24 x 74	5	15 1/2 x 25 x 13	5	15 1/2	x 25	x 13	8	Yellow	800.00
RL825	36 x 24 x 74	5	15 1/2 x 25 x 13	5	15 1/2	x 25	x 13	8	Green	800.00
RL826	36 x 24 x 74	5	15 1/2 x 25 x 13	5	15 1/2	x 25	x 13	8	Red	800.00
RL827	48 x 18 x 74	8	77/8 x 17 11/16 x 7	8	77/8	x 17 11/16	x 7	28	Blue	1295.00
		8	11 13/16 x 17 11/16 x 7	8	11 13/16	x 17 11/16	x 7	7	Blue	
RL828	48 x 18 x 74	8	77/8 x 17 11/16 x 7	8	77/8	x 17 11/16	x 7	28	Yellow	1295.00
		8	11 13/16 x 17 11/16 x 7	8	11 13/16	x 17 11/16	x 7	7	Yellow	
RL829	48 x 18 x 74	8	77/8 x 17 11/16 x 7	8	77/8	x 17 11/16	x 7	28	Green	1295.00
		8	11 13/16 x 17 11/16 x 7	8	11 13/16	x 17 11/16	x 7	7	Green	
RL830	48 x 18 x 74	8	77/8 x 17 11/16 x 7	8	77/8	x 17 11/16	x 7	28	Red	1295.00
		8	11 13/16 x 17 11/16 x 7	8	11 13/16	x 17 11/16	x 7	7	Red	
RL831	48 x 18 x 74	8	77/8 x 17 11/16 x 7	8	77/8	x 17 11/16	x 7	7	Blue	1200.00
		8	11 13/16 x 17 11/16 x 7	8	11 13/16	x 17 11/16	x 7	21	Blue	
RL832	48 x 18 x 74	8	77/8 x 17 11/16 x 7	8	77/8	x 17 11/16	x 7	7	Yellow	1200.00
		8	11 13/16 x 17 11/16 x 7	8	11 13/16	x 17 11/16	x 7	21	Yellow	
RL833	48 x 18 x 74	8	77/8 x 17 11/16 x 7	8	77/8	x 17 11/16	x 7	7	Green	1200.00
		8	11 13/16 x 17 11/16 x 7	8	11 13/16	x 17 11/16	x 7	21	Green	
RL834	48 x 18 x 74	8	77/8 x 17 11/16 x 7	8	77/8	x 17 11/16	x 7	7	Red	1200.00
		8	11 13/16 x 17 11/16 x 7	8	11 13/16	x 17 11/16	x 7	21	Red	
RL835	48 x 24 x 74	5	77/8 x 17 11/16 x 7	5	77/8	x 17 11/16	x 7	4	Blue	1050.00
		5	11 13/16 x 17 11/16 x 7	5	11 13/16	x 17 11/16	x 7	7	Blue	
		5	15 1/2 x 25 x 13	5	15 1/2	x 25	x 13	6	Blue	
RL836	48 x 24 x 74	5	77/8 x 17 11/16 x 7	5	77/8	x 17 11/16	x 7	4	Yellow	1050.00
		5	11 13/16 x 17 11/16 x 7	5	11 13/16	x 17 11/16	x 7	7	Yellow	
		5	15 1/2 x 25 x 13	5	15 1/2	x 25	x 13	6	Yellow	
RL837	48 x 24 x 74	5	77/8 x 17 11/16 x 7	5	77/8	x 17 11/16	x 7	4	Green	1050.00
		5	11 13/16 x 17 11/16 x 7	5	11 13/16	x 17 11/16	x 7	7	Green	
		5	15 1/2 x 25 x 13	5	15 1/2	x 25	x 13	6	Green	
RL838	48 x 24 x 74	5	77/8 x 17 11/16 x 7	5	77/8	x 17 11/16	x 7	4	Red	1050.00
		5	11 13/16 x 17 11/16 x 7	5	11 13/16	x 17 11/16	x 7	7	Red	
		5	15 1/2 x 25 x 13	5	15 1/2	x 25	x 13	6	Red	
RL839	36 x 18 x 74	8	77/8 x 17 11/16 x 7	8	77/8	x 17 11/16	x 7	7	Blue	975.00
		8	11 13/16 x 17 11/16 x 7	8	11 13/16	x 17 11/16	x 7	14	Blue	
RL840	36 x 18 x 74	8	77/8 x 17 11/16 x 7	8	77/8	x 17 11/16	x 7	7	Yellow	975.00
		8	11 13/16 x 17 11/16 x 7	8	11 13/16	x 17 11/16	x 7	14	Yellow	
RL841	36 x 18 x 74	8	77/8 x 17 11/16 x 7	8	77/8	x 17 11/16	x 7	7	Green	975.00
		8	11 13/16 x 17 11/16 x 7	8	11 13/16	x 17 11/16	x 7	14	Green	
RL842	36 x 18 x 74	8	77/8 x 17 11/16 x 7	8	77/8	x 17 11/16	x 7	7	Red	975.00
		8	11 13/16 x 17 11/16 x 7	8	11 13/16	x 17 11/16	x 7	14	Red	

**KLETON**

## STANDARD-DUTY WIRE MESH SHELVING

- Assembly required
- Adjustable feet compensate for surface irregularities
- Posts are double grooved every 8" and numbered for easy adjustment
- Capacity is based on evenly-distributed weight
- Shelf ribs run front to back allowing items to slide on and off shelves smoothly
- Post's circular grooves combined with tapered plastic split sleeves allow for assembly in minutes with no special tools
- Shelves with open wire design minimize dust, improve air circulation and provide greater visibility of stored items
- Shelves can be adjusted at precise 1" intervals
- Unit capacity should not exceed 1000 lbs.
- NSF Certified
- Overall Capacity: 1000 lbs (evenly distributed weight)

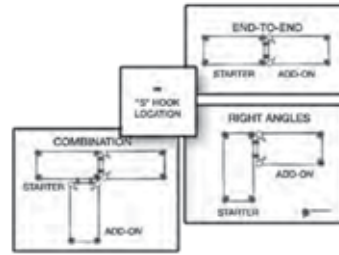

Model No.	Kit Type	Shelf Capacity lbs.*	No. of Shelves	Dimensions				Price /Each	
				W"	x	D"	x	H"	
RN529	Starter	500	4	36	x	14	x	63	199.00
RN530	Add-On	500	4	36	x	14	x	63	165.00
RN531	Starter	500	4	36	x	18	x	63	215.00
RN532	Add-On	500	4	36	x	18	x	63	184.00
RN533	Starter	500	4	48	x	18	x	63	245.00
RN534	Add-On	500	4	48	x	18	x	63	215.00
RN535	Starter	500	4	48	x	24	x	63	295.00
RN536	Add-On	500	4	48	x	24	x	63	263.00
RN537	Starter	400	4	72	x	24	x	63	419.00
RN538	Add-On	400	4	72	x	24	x	63	385.00
RN539	Starter	500	5	36	x	14	x	74	229.00
RN540	Add-On	500	5	36	x	14	x	74	199.00
RN541	Starter	500	5	36	x	18	x	74	245.00
RN542	Add-On	500	5	36	x	18	x	74	215.00
RN543	Starter	500	5	48	x	18	x	74	289.00
RN544	Add-On	500	5	48	x	18	x	74	265.00
RN545	Starter	500	5	48	x	24	x	74	345.00
RN546	Add-On	500	5	48	x	24	x	74	325.00
RN547	Starter	400	5	72	x	24	x	74	479.00
RN548	Add-On	400	5	72	x	24	x	74	445.00

\* Evenly distributed weight

## WIRE SHELVING COMPONENTS

- Shelf ribs run front to back allowing items to slide on and off shelves smoothly
- Shelves can be adjusted at precise 1" intervals
- Basket shelf design allows loose items to be contained and easily displayed
- Slanted shelf design allows for visibility and easy access to stored goods
- Slanted shelves have a 3" front lip that prevents items from sliding off the shelf
- Posts are double grooved every 8" and numbered for easy adjustment
- Adjustable feet compensate for surface irregularities
- Stationary unit's total capacity should not exceed 1000 lbs.
- NSF certified

**KLETON**

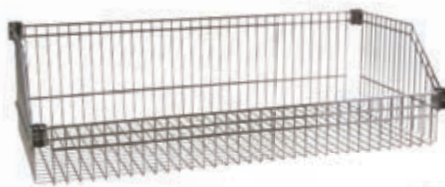

### POSTS

Model No.	Height"	Price /Each
RN522	63	20.25
RN523	74	22.95

### WIRE SHELVES

Model No.	Dimensions			Capacity lbs.*	Price /Each
	W"	x	D"		
RN524	36	x	14	500	33.25
RN525	36	x	18	500	39.00
RN526	48	x	18	500	47.95
RN527	48	x	24	500	60.95
RN528	72	x	24	400	89.95

\* Evenly distributed weight

### WIRE BASKET SHELVES

Model No.	Dimensions			Capacity lbs.*	Price /Each
	W"	x	D"		
RN549	36	x	18	400	153.00
RN550	48	x	18	400	189.00
RN551	48	x	24	400	233.00

\* Evenly distributed weight

### WIRE SLANTED SHELVES

Model No.	Dimensions			Capacity lbs.*	Price /Each
	W"	x	D"		
RN552	36	x	18	400	80.30
RN553	48	x	18	400	106.00
RN554	48	x	24	400	137.00

\* Evenly distributed weight

# WIRE SHELVING

## SLANTED WIRE SHELVING UNIT

- Slanted shelving allows for better visibility of stored items
- Includes 3 slanted shelves and 2 flat shelves
- Kit Type: Starter
- Shelf Capacity: 400 lbs.
- Overall Capacity: 1000 lbs.
- NSF Certified



**KLETON**

Model No.	Dimensions				Number of Shelves	Price /Each
	W"	x	D"	H"		
RN589	36	x	18	x	63	432.00
RN590	48	x	18	x	63	501.00
RN591	48	x	24	x	63	614.00
RN592	36	x	18	x	74	576.00
RN593	48	x	18	x	74	717.00
RN594	48	x	24	x	74	887.00

## SLANTED SHELF CARTS

- Slanted shelving allows for better visibility of stored items
- Includes: (3) slanted shelves, (2) flat shelves, (2) swivel casters, (2) Rigid Casters
- Kit Type: Starter
- Shelf Capacity: 400 lbs.
- Overall Capacity: 800 lbs.
- NSF Certified



**KLETON**

Model No.	Dimensions				Number of Shelves	Price /Each
	W"	x	D"	H"		
RN595	36	x	18	x	75	513.00
RN596	48	x	18	x	75	596.00
RN597	48	x	24	x	75	703.00
RN598	36	x	18	x	86	668.00
RN599	48	x	18	x	86	801.00
RN600	48	x	24	x	86	975.00

## WIRE BASKET SHELVING UNIT

- Basket shelves help to keep items organized and visible, while preventing items from falling off the shelves
- Open wire provides optimal airflow and helps to reduce dust
- Kit Type: Starter
- Shelf Capacity: 400 lbs.
- Overall Capacity: 1000 lbs.
- NSF Certified



**KLETON**

Model No.	Dimensions				Number of Shelves	Price /Each
	W"	x	D"	H"		
RN609	36	x	18	x	74	828.00
RN610	48	x	18	x	74	1007.00
RN611	48	x	24	x	74	1279.00

## WIRE BASKET SHELF CARTS

- Basket shelves help to keep items organized and visible, while preventing items from falling off the shelves
- Includes: (5) basket shelves, (2) swivel casters, (2) rigid casters
- Kit Type: Starter
- Shelf Capacity: 400 lbs.
- Overall Capacity: 800 lbs.
- No. of Shelves: 5
- NSF Certified



**KLETON**

Model No.	Dimensions				Number of Shelves	Price /Each
	W"	x	D"	H"		
RN612	36	x	18	x	80	977.00
RN613	48	x	18	x	80	1156.00
RN614	48	x	24	x	80	1379.00

## SLANTED WIRE SHELF CART WITH BINS

- Slanted shelving allows for better visibility of stored items
- Features 3 slanted shelves, 2 flat shelves
- Kit Type: Starter
- Shelf Capacity: 400 lbs.
- Overall Capacity: 1000 lbs.
- No. of Shelves: 5
- NSF Certified



**KLETON**

Model No.	Dimensions				Number of Bins	Bin Colour	Price /Each
	W"	x	D"	H"			
RN601	63	x	18	x	36	Blue	754.00
RN602	63	x	18	x	36	Yellow	754.00
RN603	63	x	18	x	36	Green	754.00
RN604	63	x	18	x	36	Red	754.00
RN605	63	x	18	x	48	Blue	933.00
RN606	63	x	18	x	48	Yellow	933.00
RN607	63	x	18	x	48	Green	933.00
RN608	63	x	18	x	48	Red	933.00

## CANNABIS DRY RACK SHELVING

- Green epoxy wire shelving is ideal for use in wet environments
- 3" wire spacing ideal for drying produce
- Superior rust resistance
- Designed to minimize dust, improve air circulation and provide greater visibility of stored items
- Post's circular grooves combined with tapered plastic sleeves allow for assembly in minutes with no special tools
- Shelves can be adjusted at precise 1" intervals
- Posts are double grooved every 8" and numbered for easy adjustment
- Adjustable feet compensate for surface irregularities
- Stationary unit's total capacity should not exceed 400 lbs. (evenly distributed)
- NSF certified
- Kit Type: Starter
- Shelf Capacity: 100 lbs.
- Overall Capacity: 400 lbs.



**KLETON**

Model No.	Dimensions				Number of Shelves	Price /Each	
	W"	x	D"	H"			
RN780	36"	x	18"	x	63"	4	230.00
RN781	48"	x	24"	x	63"	4	308.00
RN782	72"	x	24"	x	63"	4	404.00



## GREEN EPOXY FINISH WIRE SHELVING

- Ideal for use in wet environments
- Superior rust resistance
- Designed to minimize dust, improve air circulation, and provide greater visibility of stored items
- Post's circular grooves combined with tapered plastic sleeves allow for assembly in minutes with no special tools
- Shelf ribs run front to back allowing items to slide on and off shelves smoothly
- Shelves can be adjusted at precise 1" intervals
- Posts are double grooved every 8" and numbered for easy adjustment
- Adjustable feet compensate for surface irregularities
- Stationary unit's total capacity should not exceed 2000 lbs.
- Capacity is based on evenly distributed weight



### COMPLETE SHELVING UNITS

Model No.	Type	Dimensions W" x D" x H"	Cap. lbs. /Shelf*	Price /Each
<b>4 SHELVES</b>				
RN089	Starter	30 x 14 x 63	800	190.00
RN090	Add-on	30 x 14 x 63	800	164.00
RN091	Starter	36 x 14 x 63	800	209.00
RN092	Add-on	36 x 14 x 63	800	182.00
RN093	Starter	48 x 14 x 63	800	239.00
RN094	Add-on	48 x 14 x 63	800	212.00
RN095	Starter	60 x 14 x 63	600	279.00
RN096	Add-on	60 x 14 x 63	600	253.00
RN097	Starter	72 x 14 x 63	600	332.00
RN098	Add-on	72 x 14 x 63	600	307.00
RL648	Starter	36 x 18 x 63	800	243.00
RL649	Add-on	36 x 18 x 63	800	224.00
RL650	Starter	48 x 18 x 63	800	276.00
RL651	Add-on	48 x 18 x 63	800	260.00
RL652	Starter	60 x 18 x 63	600	314.00
RL653	Add-on	60 x 18 x 63	600	299.00
RL654	Starter	72 x 18 x 63	600	356.00
RL655	Add-on	72 x 18 x 63	600	341.00
RL656	Starter	36 x 24 x 63	800	283.00
RL657	Add-on	36 x 24 x 63	800	273.00
RL658	Starter	48 x 24 x 63	800	327.00
RL659	Add-on	48 x 24 x 63	800	314.00
RL660	Starter	60 x 24 x 63	600	374.00
RL661	Add-on	60 x 24 x 63	600	364.00
RN099	Starter	72 x 24 x 63	600	442.00
RN100	Add-on	72 x 24 x 63	600	415.00

\* Evenly distributed weight

### COMPLETE SHELVING UNITS

Model No.	Type	Dimensions W" x D" x H"	Cap. lbs. /Shelf*	Price /Each
<b>5 SHELVES</b>				
RN101	Starter	30 x 14 x 74	800	227.00
RN102	Add-on	30 x 14 x 74	800	201.00
RN103	Starter	36 x 14 x 74	800	249.00
RN104	Add-on	36 x 14 x 74	800	225.00
RN105	Starter	48 x 14 x 74	800	287.00
RN106	Add-on	48 x 14 x 74	800	262.00
RN107	Starter	60 x 14 x 74	600	338.00
RN108	Add-on	60 x 14 x 74	600	312.00
RN109	Starter	72 x 14 x 74	600	407.00
RN110	Add-on	72 x 14 x 74	600	381.00
RL662	Starter	36 x 18 x 74	800	296.00
RL663	Add-on	36 x 18 x 74	800	285.00
RL664	Starter	48 x 18 x 74	800	339.00
RL665	Add-on	48 x 18 x 74	800	326.00
RL666	Starter	60 x 18 x 74	600	382.00
RL667	Add-on	60 x 18 x 74	600	371.00
RL668	Starter	72 x 18 x 74	600	437.00
RL669	Add-on	72 x 18 x 74	600	426.00
RL670	Starter	36 x 24 x 74	800	364.00
RL671	Add-on	36 x 24 x 74	800	351.00
RL672	Starter	48 x 24 x 74	800	402.00
RL673	Add-on	48 x 24 x 74	800	392.00
RL674	Starter	60 x 24 x 74	600	488.00
RL675	Add-on	60 x 24 x 74	600	476.00
RN111	Starter	72 x 24 x 74	600	542.00
RN112	Add-on	72 x 24 x 74	600	518.00
RN113	Starter	36 x 18 x 86	800	280.00
RN114	Add-on	36 x 18 x 86	800	253.00
RN115	Starter	48 x 18 x 86	800	337.00
RN116	Add-on	48 x 18 x 86	800	309.00
RN117	Starter	60 x 18 x 86	600	382.00
RN118	Add-on	60 x 18 x 86	600	355.00
RN119	Starter	72 x 18 x 86	600	431.00
RN120	Add-on	72 x 18 x 86	600	404.00
RN121	Starter	36 x 24 x 86	800	325.00
RN122	Add-on	36 x 24 x 86	800	295.00
RN123	Starter	48 x 24 x 86	800	397.00
RN124	Add-on	48 x 24 x 86	800	369.00
RN125	Starter	60 x 24 x 86	600	475.00
RN126	Add-on	60 x 24 x 86	600	447.00
RN127	Starter	72 x 24 x 86	600	549.00
RN128	Add-on	72 x 24 x 86	600	520.00

\* Evenly distributed weight



#### POSTS

Model No.	Height"	Price/Each
RL629	63	19.45
RL630	74	21.95
RL631	86	25.65

#### WIRE SHELVES

Model No.	Dimensions W" x D"	Cap. lbs. /Shelf*	Price /Each
RN082	30 x 14	800	30.85
RN083	36 x 14	800	36.10
RN084	48 x 14	800	41.85
RN085	60 x 14	600	54.45
RN086	72 x 14	600	73.25
RN087	30 x 18	800	35.10
RL622	36 x 18	800	43.15
RL623	48 x 18	800	51.60
RL624	60 x 18	600	60.90
RL625	72 x 18	600	71.60
RL626	36 x 24	800	53.20
RL627	48 x 24	800	64.80
RL628	60 x 24	600	76.95
RN077	72 x 24	600	91.50

\* Evenly distributed weight

## GREEN EPOXY FINISH WIRE SHELF CARTS

- Green epoxy wire shelf carts are ideal for use in wet environments
- Superior rust resistance
- Designed to minimize dust, improve air circulation, and provide greater visibility of stored items
- Shelves can be adjusted quickly and easily
- Strong and versatile
- Capacity: 600 lbs. evenly distributed
- Includes: 5" resilient rubber casters, two swivel, two with brake
- NSF certified
- One year limited warranty
- Shipped knocked down



RL803



#### 5 SHELVES

Model No.	Dimensions W" x D" x H"	Price /Each
RL809	18 x 36 x 92	395.00
RL810	18 x 48 x 92	445.00
RL811	18 x 60 x 92	485.00
RL812	24 x 36 x 92	445.00
RL813	24 x 48 x 92	495.00
RL814	24 x 60 x 92	569.00

## WIRE SHELF PUSH CART

- Capacity is based on evenly distributed weight
- Features 24" green epoxy handle for improved maneuverability
- Green epoxy wire shelf carts are ideal for use in wet environments
- Superior rust resistance
- Designed to minimize dust, improve air circulation and provide greater visibility of stored items
- Shelves can be adjusted quickly and easily
- **Includes:**
  - (1) 24" Green epoxy handle,
  - (2) 5" Swivel resilient rubber casters,
  - (2) 5" Resilient rubber casters with brakes
- Shipped knocked-down
- NSF certified



RN798



Model No.	No. of Shelves	Dimensions W" x D" x H"	Cap. lbs. /Shelf*	Price /Each
RN798	4	36 x 24 x 69	800	339.00
RN799	4	48 x 24 x 69	800	395.00
RN800	4	60 x 24 x 69	800	459.00
RN801	5	36 x 24 x 69	800	375.00
RN802	5	48 x 24 x 69	800	435.00
RN803	5	72 x 24 x 69	800	509.00

\* Evenly distributed weight



# WIRE SHELVING

## WIRE MESH UTILITY CARTS

- Durable, dependable transport solution that is easy to manoeuvre
- Highly rigid construction that is easily adjustable at 1" increments
- Two handles, indicated number of shelves, and casters
- Capacity: 800 lbs. evenly distributed
- Shipped knocked down
- NSF certified
- **One-year limited warranty**



Model No.	Dimensions W" x D" x H"	Price /Each
<b>2 SHELVES</b>		
MK781	30 x 18 x 39	239.00
MK782	36 x 18 x 39	239.00
MK783	48 x 18 x 39	255.00
MK784	60 x 18 x 39	319.00
MK785	36 x 24 x 39	275.00
MK786	48 x 24 x 39	295.00
MK787	60 x 24 x 39	335.00
<b>3 SHELVES</b>		
MJ539	30 x 18 x 39	275.00
MJ540	36 x 18 x 39	285.00
MJ541	48 x 18 x 39	295.00
MJ542	60 x 18 x 39	345.00
MJ543	36 x 24 x 39	305.00
MJ544	48 x 24 x 39	355.00
MJ545	60 x 24 x 39	395.00

## PUSH CARTS

- Durable, dependable transport solution
- Easy maneuverability
- Shelves can be adjusted quickly and easily
- Capacity: 800 lbs. evenly distributed
- Shipped knocked down
- **One-year limited warranty**



Model No.	Dimensions W" x D" x H"	Price /Each
<b>4 SHELVES</b>		
RL914	30 x 14 x 60	285.00
RL915	36 x 14 x 60	309.00
RL916	48 x 14 x 60	345.00
RL917	60 x 14 x 60	379.00
<b>5 SHELVES</b>		
RL918	30 x 14 x 60	309.00
RL919	36 x 14 x 60	355.00
RL920	48 x 14 x 60	395.00
RL921	60 x 14 x 60	449.00

## WIRE SHELF CARTS

- Open-wire shelf design minimizes dust and increases air circulation and visibility
- High quality chromate shelves and posts prevent corrosion
- Shelves can be adjusted quickly and easily
- Strong and versatile
- Includes: 5" resilient rubber casters (two swivel, two with brake)
- Capacity: 800 lbs. evenly distributed
- Shipped knocked down
- NSF certified
- **One-year limited warranty**



Model No.	Dimensions W" x D" x H"	Price /Each
<b>4 SHELVES</b>		
RL600	36 x 18 x 69	349.00
RL601	48 x 18 x 69	385.00
RL602	60 x 18 x 69	425.00
RL603	36 x 24 x 69	369.00
RL604	48 x 24 x 69	435.00
RL605	60 x 24 x 69	485.00
MJ527	36 x 18 x 80	365.00
MJ528	48 x 18 x 80	395.00
MJ529	60 x 18 x 80	415.00
MJ530	36 x 24 x 80	379.00
MJ531	48 x 24 x 80	449.00
MJ532	60 x 24 x 80	495.00
<b>5 SHELVES</b>		
MJ533	36 x 18 x 92	409.00
MJ534	48 x 18 x 92	469.00
MJ535	60 x 18 x 92	519.00
MJ536	36 x 24 x 92	439.00
MJ537	48 x 24 x 92	515.00
MJ538	60 x 24 x 92	589.00

## GREEN EPOXY WIRE SHELF CARTS

- Green epoxy wire shelf carts are ideal for use in wet environments
- Superior rust resistance
- Designed to minimize dust, improve air circulation, and provide greater visibility of stored items
- Shelves can be adjusted quickly and easily
- Strong and versatile
- Includes: 5" resilient rubber casters (two swivel, two with brake)
- Capacity: 800 lbs. evenly distributed
- Shipped knocked down
- **One-year limited warranty**



Model No.	Dimensions W" x D" x H"	Price /Each
<b>4 SHELVES</b>		
RN129	36 x 18 x 69	395.00
RN130	48 x 18 x 69	339.00
RN131	60 x 18 x 69	375.00
RN132	36 x 24 x 69	335.00
RN133	48 x 24 x 69	389.00
RN134	60 x 24 x 69	445.00
RL803	18 x 36 x 80	345.00
RL804	18 x 48 x 80	385.00
RL805	18 x 60 x 80	419.00
RL806	24 x 36 x 80	389.00
RL807	24 x 48 x 80	429.00
RL808	24 x 60 x 80	479.00
<b>5 SHELVES</b>		
RL809	18 x 36 x 92	395.00
RL810	18 x 48 x 92	445.00
RL811	18 x 60 x 92	485.00
RL812	24 x 36 x 92	445.00
RL813	24 x 48 x 92	495.00
RL814	24 x 60 x 92	569.00



## SECURITY CARTS

- Security carts are ideal for safety storing and transporting of valuable goods
- Open wire construction allows for visibility into the unit so items can be checked at any time
- Double door design that allows for each door to open 270 degrees and can be secured along the side
- Shipped knocked-down



RL408



RL399



Model No	Overall Dimensions			No. of Shelves	Price /Each
	W"	x D"	x H"		
<b>STATIONARY</b>					
RL399	38.5	x 21.5	x 66 13/16	4	2078.00
RL400	50.5	x 21.5	x 66 13/16	4	2567.00
RL402	38.5	x 21.5	x 66 13/16	5	2183.00
RL403	50.5	x 21.5	x 66 13/16	5	2697.00
<b>MOBILE</b>					
RL408	38.5	x 21.5	x 68 1/2	4	2403.00
RL409	50.5	x 21.5	x 68 1/2	4	2886.00
RL411	38.5	x 21.5	x 68 1/2	5	2508.00
RL412	50.5	x 21.5	x 68 1/2	5	3012.00

## ENCLOSED WIRE STOCK PICKING CARTS

- High quality chromate shelves and posts prevent corrosion
- Enclosed sides keeps items from falling out
- Shelves can be adjusted quickly and easily
- Strong and versatile
- Includes: (2) 5" swivel resilient casters, (2) 5" rubber caster with brakes
- Shipped knocked down
- Capacity is based on evenly distributed weight
- No. of Shelves: 4
- Capacity: 800 lbs.
- Cart Material: Chrome Plated
- NSF Certified
- **One-year limited warranty**

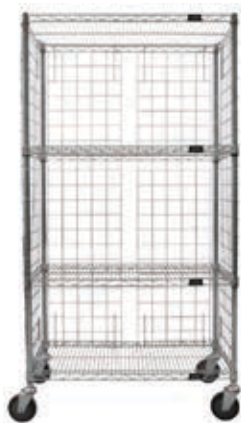

RN559

Model No.	Dimensions			Price /Each
	W"	x D"	x H"	
RN559	36	x 18	x 69	529.00
RN560	48	x 18	x 69	659.00
RN561	60	x 18	x 69	749.00
RN562	36	x 24	x 69	689.00
RN563	48	x 24	x 69	759.00
RN564	60	x 24	x 69	785.00

## WIRE ENCLOSURE PANELS

Model No.	Dimensions			Price /Each
	W"	x D"	x H"	
RN556	15	x	61.5	64.65
RN557	18	x	61.5	70.80
RN558	21	x	61.5	77.35

## COVERS FOR SHELF TRUCKS & CARTS

- Protect contents from dust and other air-borne contaminants
- Covers deter pilferage and allow units to be loaded prior to transport
- Available in either uncoated nylon or coated waterproof vinyl, with an aluminum zippered closure
- Colour: White.
- **Please note:** Axll covers are non-returnable



RG460



Nylon Size L" x H"	Uncoated Model No.	Price /Each	Vinyl Coated Model No.	Price /Each
<b>FOR SHELF TRUCKS AND CARTS 18" WIDE</b>				
36 x 54	RG460	278.00	RG466	461.00
36 x 62	RG461	289.00	RG467	471.00
48 x 54	RG462	310.00	RG468	482.00
48 x 62	RG463	310.00	RG469	499.00
60 x 54	RG464	320.00	RG470	524.00
60 x 62	RG465	320.00	RG471	534.00
<b>FOR SHELF TRUCKS AND CARTS 24" WIDE</b>				
36 x 54	RG472	320.00	RG478	478.00
36 x 62	RG473	320.00	RG479	499.00
48 x 54	RG474	331.00	RG480	562.00
48 x 62	RG475	387.00	RG481	572.00
60 x 54	RG476	446.00	RG482	614.00
60 x 62	RG477	457.00	RG483	629.00

Note: Other colours available.

## WIRE SHELVING UNIT WITH PLASTIC SHELVES

- Steel wire mesh frame with durable, clip-in plastic shelves
- Unit ships knocked-down in single box
- Snap together design assembles in minutes
- Smooth, vented, open-grid surface allows for air circulation and minimal dust build-up
- Plastic shelves can easily be removed from wire shelves for easy cleaning, and are dishwasher safe
- Plastic will not dent, chip, rust or corrode
- Shelves easily adjust to your exact height needs
- Steel posts and frames with anti-bacterial blue finish
- No. of Shelves: 4
- Shelf Capacity: 600 lbs.
- Shelving Unit Type: Boltless
- Style: Open
- Frame Colour: Blue
- Shelf Colour: White



CG077



Model No.	Mfg. No.	Dimensions W" x D" x H"	Price /Each
CG077	RPWR72-1830E	30 x 18 x 72	479.00
CG078	RPWR72-1836E	36 x 18 x 72	565.00
CG079	RPWR72-1848E	48 x 18 x 72	709.00
CG080	RPWR72-2430E	30 x 24 x 72	605.00
CG081	RPWR72-2436E	36 x 24 x 72	709.00
CG082	RPWR72-2448E	48 x 24 x 72	905.00



# PIPE FITTINGS

## PIPE FITTINGS

There are many variations of fittings to suit a wide range of applications, providing the versatility to achieve any structural configuration. Kee Klamp® fittings are galvanized malleable iron castings designed to suit eight sizes of tube. A standard hex key and tube cutters are the only tools required to create strong, rigid structures. Recessed set screws, tightened by the hex key, firmly lock the tube into the fitting. The set screw is manufactured in case hardened steel and is coated to protect against corrosion.



### KEE KLAMP®

- Simple method of constructing tubular structures
- Cost effective alternative to welding
- Galvanized to resist corrosion



### SHORT TEES

Model No.	Pipe O.D."	Price /Each
RK597	1.05	15.90
RK598	1.315	18.90
RK599	1.66	26.50
RK600	1.90	30.50
RK601	2.375	57.50



### LONG TEES

Model No.	Pipe O.D."	Price /Each
RK602	1.05	29.90
RK603	1.315	28.50
RK604	1.66	44.90
RK605	1.90	49.50
RK606	2.375	78.90



### SIDE OUTLET TEES

Model No.	Pipe O.D."	Price /Each
RK607	1.05	23.90
RK608	1.315	24.50
RK609	1.66	35.90
RK610	1.90	40.50
RK611	2.375	74.90



### TWO SOCKET CROSSES

Model No.	Pipe O.D."	Price /Each
RK612	1.05	24.90
RK613	1.315	28.50
RK614	1.66	34.50
RK615	1.90	45.50
RK616	2.375	76.90



### 90° ELBOWS

Model No.	Pipe O.D."	Price /Each
RK617	1.05	21.90
RK618	1.315	23.50
RK619	1.66	30.90
RK620	1.90	49.90
RK621	2.375	65.50



### ANGLE CROSSES

Model No.	Pipe O.D."	Price /Each
N/A	1.05	-
RK622	1.315	129.00
RK623	1.66	155.00
N/A	1.90	-
N/A	2.375	-



### ANGLE TEES

Model No.	Pipe O.D."	Price /Each
N/A	1.05	-
N/A	1.315	-
RK626	1.66	61.50
RK627	1.90	69.50
N/A	2.375	-



### 3 WAY 90° ELBOWS

Model No.	Pipe O.D."	Price /Each
RK628	1.05	32.50
RK629	1.315	31.50
RK630	1.66	45.50
RK631	1.90	56.50
N/A	2.375	-



### ADJUSTABLE SHORT TEES

Model No.	Pipe O.D."	Price /Each
N/A	1.05	-
RK632	1.315	28.90
RK633	1.66	38.90
RK634	1.90	44.50
N/A	2.375	-



### ADJUSTABLE TWO SOCKET CROSSES

Model No.	Pipe O.D."	Price /Each
N/A	1.05	-
RK635	1.315	46.90
RK636	1.66	62.50
RK637	1.90	71.50
N/A	2.375	-



### BASE FLANGES

Model No.	Pipe O.D."	Price /Each
RK638	1.05	18.90
RK639	1.315	20.50
RK640	1.66	28.50
RK641	1.90	36.50
RK642	2.375	51.50



### RAILING BASE FLANGES

Model No.	Pipe O.D."	Price /Each
RK643	1.05	35.50
RK644	1.315	34.90
RK645	1.66	40.50
RK646	1.90	52.50
RK647	2.375	71.90



### PLASTIC END PLUGS

Model No.	Pipe O.D."	Price /Each
RA179	1.05	2.59
RA180	1.315	2.89
RA181	1.66	3.19
RA182	1.90	3.19
RA183	2.375	3.19



### GROUND SOCKETS

Model No.	Pipe O.D."	Price /Each
N/A	1.05	-
RK648	1.315	74.50
RK649	1.66	97.50
RK650	1.90	105.00
N/A	2.375	-



### CLAMP-ON TEES

Model No.	Pipe O.D."	Price /Each
RK651	1.05	42.90
RK652	1.315	44.90
RK653	1.66	52.90
RK654	1.90	62.50
N/A	2.375	-



### GATE EYES

Model No.	Pipe O.D."	Price /Each
RK655	1.05	17.50
RK656	1.315	18.50
RK657	1.66	20.50
RK658	1.90	22.90
N/A	2.375	-

## PIPE FITTINGS



**GATE HINGES**

Model No.	Pipe O.D."	Price /Each
RK659	1.05	19.50
RK660	1.315	20.90
RK661	1.66	23.50
RK662	1.90	25.90
N/A	2.375	-



**HANDRAIL BRACKETS**

Model No.	Pipe O.D."	Price /Each
RK663	1.05	26.90
RK664	1.315	25.50
RK665	1.66	33.90
RK666	1.90	42.50
N/A	2.375	-



**VERTICAL RAILING SUPPORTS**

Model No.	Pipe O.D."	Price /Each
N/A	1.05	-
RK667	1.315	58.50
RK668	1.66	76.50
RK669	1.90	91.50
N/A	2.375	-



**HORIZONTAL RAILING SUPPORTS**

Model No.	Pipe O.D."	Price /Each
N/A	1.05	-
RK670	1.315	57.50
N/A	1.66	-
N/A	1.90	-
N/A	2.375	-



**SIDE PALM FIXINGS**

Model No.	Pipe O.D."	Price /Each
N/A	1.05	-
RK671	1.315	40.50
RK672	1.66	39.90
RK673	1.90	45.90
N/A	2.375	-



**INTERNAL SWIVEL TEES**

Model No.	Pipe O.D."	Price /Each
N/A	1.05	-
RK674	1.315	31.90
RK675	1.66	44.50
RK676	1.90	51.50
N/A	2.375	-



**SHORT SWIVEL TEES**

Model No.	Pipe O.D."	Price /Each
RK677	1.05	48.50
RK678	1.315	52.90
RK679	1.66	67.90
RK680	1.90	68.50
N/A	2.375	-



**SLEEVE JOINTS**

Model No.	Pipe O.D."	Price /Each
RK681	1.05	20.90
RK682	1.315	20.90
RK683	1.66	28.90
RK684	1.90	32.90
RK685	2.375	45.90



**INTERNAL JOINTS**

Model No.	Pipe O.D."	Price /Each
N/A	1.05	-
RK686	1.315	22.50
RK687	1.66	30.50
RK688	1.90	44.50
N/A	2.375	-



**4-WAY CROSSES**

Model No.	Pipe O.D."	Price /Each
RK689	1.05	44.90
RK690	1.315	52.90
RK691	1.66	75.50
RK692	1.90	87.50
N/A	2.375	-



**CLAMP-ON CROSSOVERS**

Model No.	Pipe O.D."	Price /Each
RK693	1.05	15.90
RK694	1.315	18.50
RK695	1.66	29.90
RK696	1.90	32.50
N/A	2.375	-



**90° CROSSOVERS**

Model No.	Pipe O.D."	Price /Each
RK697	1.05	26.90
RK698	1.315	22.50
RK699	1.66	30.90
RK700	1.90	36.50
RK701	2.375	54.50



**TEE/CROSSOVER COMBINATIONS**

Model No.	Pipe O.D."	Price /Each
RK702	1.05	29.90
RK703	1.315	29.90
RK704	1.66	37.50
RK705	1.90	57.90
RK706	2.375	86.50



**DOUBLE SWIVELS**

Model No.	Pipe O.D."	Price /Each
RK707	1.05	69.50
RK709	1.315	67.50
RK711	1.66	77.90
RK713	1.90	87.50
RK715	2.375	169.00



**MALE DOUBLE SWIVELS**

Model No.	Pipe O.D."	Price /Each
RK708	1.05	31.50
RK710	1.315	29.90
RK712	1.66	31.90
RK714	1.90	32.90
RK716	2.375	48.50



**MALE CORNER SWIVELS**

Model No.	Pipe O.D."	Price /Each
N/A	1.05	-
RK718	1.315	34.50
RK720	1.66	39.50
RK722	1.90	38.50
N/A	2.375	-



**CORNER SWIVELS**

Model No.	Pipe O.D."	Price /Each
N/A	1.05	-
RK717	1.315	69.50
RK719	1.66	83.90
RK721	1.90	83.90
N/A	2.375	-



**BASE PLATES**

Model No.	Pipe O.D."	Price /Each
RK728	1.05	24.50
N/A	1.315	-
N/A	1.66	-
N/A	1.90	-
N/A	2.375	-



**SWIVEL BASES**

Model No.	Pipe O.D."	Price /Each
RK723	1.05	42.90
RK724	1.315	41.90
RK725	1.66	47.50
RK726	1.90	51.90
RK727	2.375	83.50



**MESH PANEL CLIPS**

Model No.	Pipe O.D."	Price /Each
RK729	1.05	7.09
RK730	1.315	7.09
RK731	1.66	8.19
RK732	1.90	8.19
N/A	2.375	-

# PIPE FITTINGS

## PIPE FITTINGS



**SINGLE SWIVEL SOCKETS**

Model No.	Pipe O.D."	Price /Each
RK739	1.05	16.90
RK742	1.315	16.90
RK745	1.66	20.90
RK748	1.90	21.50
RK751	2.375	38.90



**FEMALE SWIVEL SOCKETS**

Model No.	Pipe O.D."	Price /Each
RK738	1.05	17.90
RK741	1.315	17.50
RK744	1.66	22.50
RK747	1.90	26.50
RK750	2.375	57.90



**SINGLE SWIVEL COMBINATIONS**

Model No.	Pipe O.D."	Price /Each
RK737	1.05	35.90
RK740	1.315	35.50
RK743	1.66	41.50
RK746	1.90	48.50
RK749	2.375	97.90



**OUTLET TEES**

Model No.	Pipe O.D."	Price /Each
RK752	1.05	29.50
RK753	1.315	34.90
RK754	1.66	50.50
RK755	1.90	54.90
RK756	2.375	119.00



**LOCKING COLLARS**

Model No.	Pipe O.D."	Price /Each
RK757	1.05	11.90
RK758	1.315	13.90
RK759	1.66	17.90
RK760	1.90	16.50
N/A	2.375	-



**HOOKS**

Model No.	Pipe O.D."	Price /Each
N/A	1.05	-
RK761	1.315	14.50
RK821	1.66	19.90
RK763	1.90	21.50
N/A	2.375	-



**EAVES FITTINGS**

Model No.	Pipe O.D."	Price /Each
N/A	1.05	-
N/A	1.315	-
N/A	1.66	-
RA301	1.90	69.90
N/A	2.375	-



**WEATHER CAPS**

Model No.	Pipe O.D."	Price /Each
N/A	1.05	-
RK766	1.315	52.90
RK767	1.66	52.50
RK768	1.90	66.90
N/A	2.375	-



**ADJUSTABLE FIXING BRACKETS**

Model No.	Pipe O.D."	Price /Each
N/A	1.05	-
N/A	1.315	-
N/A	1.66	-
RK817	1.90	22.50
N/A	2.375	-

## TOOLS



Model No.	Description	Price /Each
TX413	T-Handle hex key for 1.05", 1.315" and 1.66" pipes	14.20
TX414	T-Handle hex key for 1.90" and 2.375" pipes	21.80

## PIPES

Build an unlimited array of strong rigid structures combining standard black iron (unthreaded) pipe or galvanized (threaded - on one side) pipe (schedule 40), with any combination of corresponding sized Kee Klamp® fittings. Pipe sizes are available from 1.05" to 2.375" (outside diameter). Standard pipe length is 21 ft., with cut lengths available upon request. A cutting charge will be added per cut length of piping.

Call for pricing.

Pipe O.D."	Pipe I.D."	Pipe Length'	Black Iron Model No.	Galvanized Iron Model No.
1.05	0.75	21	RA109	RA110
1.315	1	21	RA111	RA112
1.66	1.25	21	RA113	RA114
1.90	1.5	21	RA115	RA116
2.375	2	21	RA117	RA118

Model No. RG259 Cutting charge per cut length  
Price/Each \$5.99





## STRIP CURTAIN DOORS

Everything you need in one package to install your own strip curtain door and save money!

### ORDERING INFORMATION

Every strip curtain door comes complete with PVC strips, universal mounting header, hardware to attach strips and simple to follow installation instructions for door or wall mounting.

**Note:** If mounting on door above lintel, measure from floor to mounting height.

2. Select type of PVC material required: STANDARD or LOW TEMP.  
**Standard** recommended for temperatures from -23°C to 66°C.  
**Low Temp.** recommended for interior use only for temperatures from -40°C to 66°C.

3. Select from the standard sizes listed in the chart below.

**Note:** If required size is not available, order the next largest size. Installation instructions describe how simple trimming can custom fit almost any door opening.

4. Special size doors and hanging applications are available upon request.
5. For overhead doors, please call one of our sales representatives for assistance.



### INTERIOR DOORS



#### Save energy costs

- The optimal solution to open door heat/cooling loss

#### Reduce noise pollution

- Provides the ideal acoustical barrier around noisy equipment

Every strip curtain door comes complete with PVC strips, universal mounting header, hardware to attach strips and simple to follow installation instructions for door or wall mounting.

### EASY TO ORDER

It's easy to order the strip curtain that fits your door exactly because seven standard sizes can be made to fit 95% of most door openings.

**Special sizes are available.**

### IN-STOCK DELIVERY

We have the strip curtain package you need, in-stock, ready to be delivered to your door.

### CONVEYORS

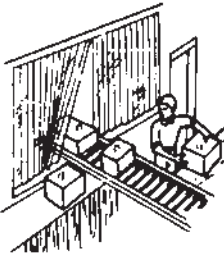

#### Provide extra safe passage

- People can see and be seen so there's less chance of accidents

#### Control smoke, dust and sprays

- Strip curtains can control in-plant contaminants to improve employee environment

### STANDARD DOOR SIZES

Strip Size	Door Opening W' x H'	Wt. lbs.	Model No. Standard	Price /Each	Model No. Low Temp.	Price /Each
8"	4 x 7	25	KF022	195.00	KF004	205.00
	5 x 8	35	KF023	245.00	KF005	265.00
	6 x 8	40	KF024	275.00	KF006	309.00
12"	8 x 8	80	KF026	505.00	KF008	579.00
	8 x 10	100	KF025	605.00	KF007	695.00
	10 x 10	125	KF020	759.00	KF002	805.00
	12 x 12	175	KF021	989.00	KF003	1089.00

**Note:** Doors with 8" strips have 2" standard overlap. Doors with 12" strips have 4" standard overlap.

### REPLACEMENT STRIPS - 5 PER CARTON

Strip Size	Wt. lbs.	Model No. Standard	Price /Each	Model No. Low Temp.	Price /Each
8" x 0.080 x 8'	15	KF032	109.00	KF013	119.00
12" x 0.120 x 12'	45	KF029	259.00	KF011	309.00

### BULK ROLLS

Strip Size	Colour	Roll'	Wt. lbs.	Model No. Standard	Price /Each	Model No. Low Temp.	Price /Each
8" x 0.080	Clear	300	99	KI226	449.00	KI224	499.00
12" x 0.120	Clear	200	150	KI225	685.00	KI223	725.00

### DOCKS



#### Low maintenance

- Clear flexible vinyl resists stretching and stands up to abrasion
- All aluminum hardware is used for maximum durability
- May be quickly and easily cleaned with detergents or cleansing agents that are free from abrasives
- Deep stains and ingrained dirt can be removed by carefully applying ethanol

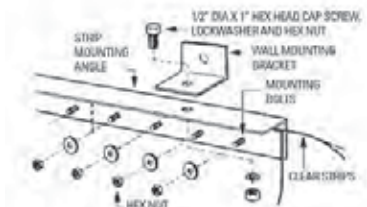

### FIXED MOUNTING SYSTEM

Model No.	Description	Price/Each
KF001	Complete 4' aluminum angle mount	69.50



Customize it to your specifications.

# ENCLOSURES & GUARDS

Rugged Kleton wire mesh partitions and enclosures provide maximum security at a minimal cost. It is ideal for the storage of tools, valuable inventory, hazardous materials and any area of your plant where restricted access is required.

Wire mesh panels permit full visibility and allow for unrestricted circulation of air, heat and light, providing an ideal storage facility.

- 2" x 2" x 10-gauge wire mesh
- 10-gauge frame (stiffeners included on all applicable sizes)
- Pre-drilled modular components allow for quick and easy installation
- Durable Kleton blue or safety yellow finish (Other colours available)



## WIRE MESH PARTITION COMPONENTS

Everything necessary to create your own custom enclosure. Fast and easy assembly, multiple sizes available. Please follow these guidelines for determining the components required.

### 1. UNIVERSAL POSTS

A post must be placed at each end of every panel (or of every stack of panels). Be sure to calculate an extra 2" of overall wall length for each post added. When a post meets an existing wall, add one **KD115** wall bracket for proper support (fasteners are included with **KD115** to mount to post, not to wall).

Universal Posts

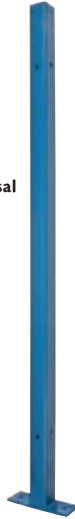

Blue Model No.	Price /Each	Yellow Model No.	Price /Each	Height	Wt. lbs.
KD053	79.95	KH860	79.95	8' 3"	22
KD046	139.00	KH922	169.00	10' 3"	27
KD050	159.00	KH923	195.00	12' 3"	32

### 2. PANELS

Whenever possible, stacking panels horizontally (one above the other) is more economical than placing them vertically (next to each other) - this is because fewer posts are required for wall support when panels are stacked.

**Examples:**

- For an 8' high partition, stack two **KD037** (8' x 4') panels horizontally
- For a 10' high partition, stack two **KD037** (8' x 4') and one **KD033** (8' x 2') panel horizontally
- For a 12' high partition, stack three **KD037** (8' x 4') panels horizontally

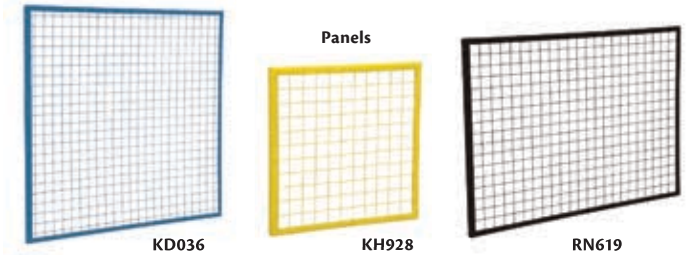

Blue Model No.	Price /Each	Yellow Model No.	Price /Each	Black Model No.	Price /Each	Frame Dimensions W' x H'	Wt. lbs.
KD121	93.50	KH926	115.00	RN615	115.00	4 x 1	10
KD120	129.00	KH927	149.00	RN616	149.00	8 x 1	21
KD030	115.00	KH928	135.00	RN617	135.00	2 x 2	10
KD031	119.00	KH929	135.00	RN618	135.00	3 x 2	11
KD032	77.60	KH914	77.60	KI278	77.60	4 x 2	12
KD033	125.00	KH915	125.00	KI279	125.00	8 x 2	31
KD034	155.00	KH916	155.00	KI280	155.00	8 x 3	40
KD035	155.00	KH930	175.00	RN619	175.00	3 x 4	20
KD036	105.00	KD130	105.00	KI281	105.00	4 x 4	23
KD037	180.00	KD131	180.00	KI282	180.00	8 x 4	45

### 3. ADJUSTABLE FILLER PANELS

Adjustable filler panels fill in blank spots on the ends of wire mesh partitions to plug up potential security risks. Filler panels come in two sizes: 1' x 4' and 1' x 8' that slide over the ends of existing wire mesh sections. Bolt holes on the filler panels are separated per every inch and allow the filler panel to fill in a space between 6" and 10" wide. The holes line up with holes on the existing panel which are drilled in at the top and bottom to securely fasten the filler panel in two places.

Adjustable Filler Panels

KH925 KD119

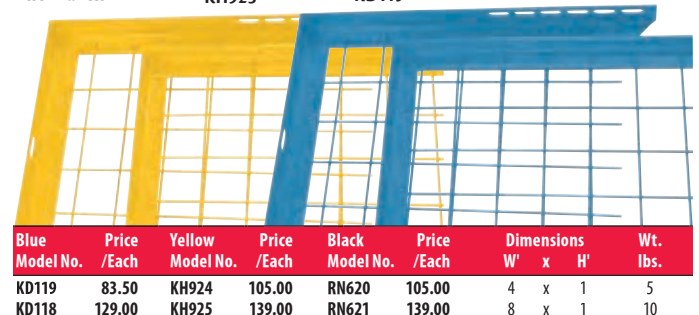

Blue Model No.	Price /Each	Yellow Model No.	Price /Each	Black Model No.	Price /Each	Dimensions W' x H'	Wt. lbs.
KD119	83.50	KH924	105.00	RN620	105.00	4 x 1	5
KD118	129.00	KH925	139.00	RN621	139.00	8 x 1	10





## WIRE MESH PARTITION COMPONENTS (CONTINUED)

Everything necessary to create your own custom enclosure. Fast and easy assembly, multiple sizes available. Please follow these guidelines for determining the components required.



**CUSTOMIZE IT TO YOUR SPECIFICATIONS.**

### 4. SWING DOORS

#### HEAVY-DUTY

- Frame constructed with 1-1/4" x 1-1/4" square tube and 1" x 1" angle iron
- All are 7' in height and include a 1' transom for a total of 8' height
- May swing outwards to the left or to the right (except the heavy swing door with wicket which swings open to the left only)
- Fasteners are included

#### STANDARD-DUTY

- Frame constructed with 1-1/4" x 1 1/4" angle iron frame
- All are 7' in height and include a 1' transom for a total of 8' height
- May swing outwards to the left or to the right
- Fasteners are included

Blue Model No.	Price /Each	Yellow Model No.	Price /Each	Black Model No.	Price /Each	Description	Dimensions W' x H'	Wt. lbs.
KD110	575.00	KH933	655.00	RN628	655.00	Heavy-Duty Swing Door	3 x 7	65
KH853	515.00	KH934	585.00	RN626	585.00	Standard-Duty Swing Door	3 x 7	54
KD111	595.00	KH935	689.00	RN629	689.00	Heavy-Duty Swing Door	4 x 7	74
KH854	505.00	KH936	585.00	RN627	585.00	Standard-Duty Swing Door	4 x 7	62
KD112	1399.00	KH937	1605.00	RN630	1605.00	Heavy-Duty Swing Door w/Wicket	4 x 7	85

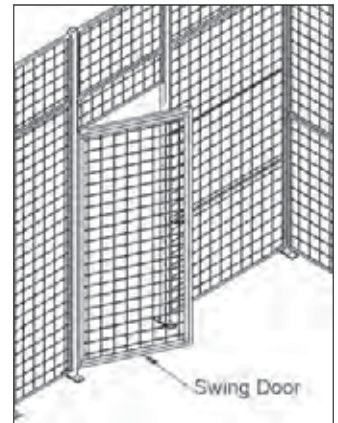

### 5. SLIDING DOORS

#### HEAVY-DUTY

- Frame constructed with 1-1/4" x 1-1/4" square tube and 1" x 1" angle iron
- All are 7' in height and require one or more 8' lengths of 5" tall sliding door track, for a total of 8' height
- All sliding doors may slide open to the left or to the right
- To properly mount a sliding door, a post must be located on the side onto which the door slides, at the same distance away from the opening as the doors width

#### STANDARD-DUTY

- Frame constructed with 1-1/2" x 1-1/2" angle iron frame
- All are 7' in height and require one or more 8' lengths of 5" tall sliding door track, for a total of 8' height
- All sliding doors may slide open to the left or to the right
- To properly mount a sliding door, a post must be located on the side onto which the door slides, at the same distance away from the opening as the doors width

Blue Model No.	Price /Each	Yellow Model No.	Price /Each	Black Model No.	Price /Each	Description	Dimensions W' x H'	Wt. lbs.
KH852	319.00	KH938	365.00	RN625	365.00	Standard-Duty Sliding Door	4 x 8	71
KD106	365.00	KH939	419.00	RN622	419.00	Heavy-Duty Sliding Door	4 x 8	85
KD108	805.00	KH940	935.00	RN624	935.00	Heavy-Duty Sliding Door	8 x 8	122
KD107	1409.00	KH941	1629.00	RN623	1629.00	Heavy-Duty Sliding Door	8 x 10	148

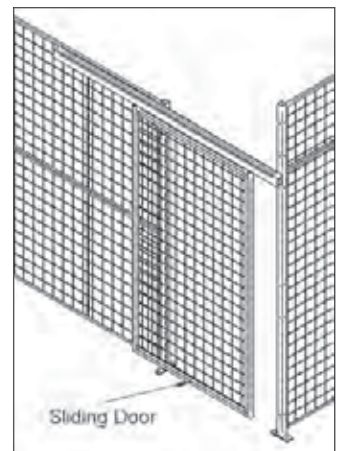

### 6. HARDWARE REQUIRED

#### For Each Stacked Panel Add:

- 4 x MMH254, 4 x MMM966 for each 8' stacked panel
- 2 x MMH254, 2 x MMM966 for each stacked panel under 8' long

#### For Each Post Add:

- 8 x MMH262, 8 x MMM966, 2 x KD001 for each 8' 3" post
- 12 x MMH262, 12 x MMM966, 2 x KD001 for each 10' 3" post
- 12 x MMH262, 12 x MMM966, 2 x KD001 for each 12' 3" post

#### For Each Sliding Door Add:

- 1 x Sliding Door Hardware Kit, 1 x 8' Door Track for each 4' wide sliding door (see chart for colours)
- 1 x Sliding Door Hardware Kit, 2 x 8' Door Track for each 8' wide sliding door (see chart for colours)

Blue Model No.	Price /Each	Yellow Model No.	Price /Each	Black Model No.	Price /Each	Description	Wt. lbs.
KD029	179.00	KH942	195.00	RN656	195.00	8' Door Track	16
KD028	149.00	KH943	165.00	RN655	155.00	Sliding Door Hardware Kit	6
KD115	21.50	KH944	26.50	-	-	Wall Bracket Kit	0.1
MMH254*	0.14	-	-	-	-	5/16" x 1" Carriage Bolt	0.01
MMH262*	0.30	-	-	-	-	5/16" x 3" Carriage Bolt	0.01
MMM966	0.04	-	-	-	-	Nut 5/16" Hex	0.01
KD001	0.68	-	-	-	-	3/8" Floor Anchors	0.01

\* 1 x MMM966 is required for each MMH254 and MMH262



# ENCLOSURES & GUARDS

## WIRE MESH PARTITION KITS

Rugged Kleton wire mesh partitions and enclosures provide maximum security at low cost for tools, valuable inventory, hazardous materials, and any area of your plant where restricted access is required. Bolt-down posts and reinforced panels provide the strength that your application demands. Standard **STOCK SIZES** include all basic bolt-together hardware required for fast and easy installation of modular wall and roof panels, and a standard 4' x 8' or 8' x 8' sliding door which may be located on any side, opening left-to-right or right-to-left. This system provides the versatility needed to expand or modify your enclosure quickly and at minimum cost. Order an enclosure with a roof for maximum security. **CUSTOM SIZES** can be designed to suit your special application regardless of the size required.

Colour: Kleton blue.



# KLETON

TYPE A - 2 SIDES

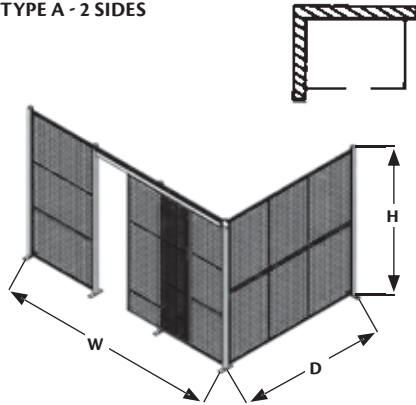

Unit Height	Overall Wall Size		Standard Sliding Door Size		Without Roof			With Roof		
	W	x D	W'	x H'	Model No.	Wt. lbs.	Price /Each	Model No.	Wt. lbs.	Price /Each
8'3"	12'8"	x 8'4"	4	x 8	<b>KD069</b>	417	<b>1728.00</b>	<b>KD070</b>	670	<b>2935.00</b>
8'3"	16'8"	x 12'6"	4	x 8	<b>KD057</b>	535	<b>2054.00</b>	<b>KD058</b>	1009	<b>4021.00</b>
8'3"	24'8"	x 16'6"	8	x 8	<b>KD061</b>	682	<b>2896.00</b>	<b>KD062</b>	1485	<b>6274.00</b>
12'3"	12'8"	x 8'4"	4	x 8	<b>KD067</b>	583	<b>2624.00</b>	<b>KD068</b>	836	<b>3818.00</b>
12'3"	16'8"	x 12'6"	4	x 8	<b>KD055</b>	758	<b>3053.00</b>	<b>KD056</b>	1232	<b>5035.00</b>
12'3"	24'8"	x 16'6"	8	x 8	<b>KD059</b>	977	<b>4338.00</b>	<b>KD060</b>	1780	<b>7404.00</b>

TYPE B - 3 SIDES

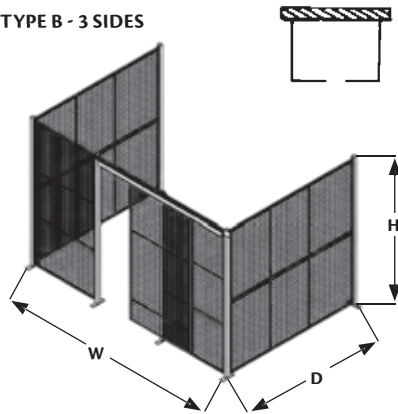

Unit Height	Overall Wall Size		Standard Sliding Door Size		Without Roof			With Roof		
	W	x D	W'	x H'	Model No.	Wt. lbs.	Price /Each	Model No.	Wt. lbs.	Price /Each
8'3"	12'8"	x 8'4"	4	x 8	<b>KD085</b>	511	<b>2059.00</b>	<b>KD086</b>	758	<b>3208.00</b>
8'3"	16'8"	x 12'6"	4	x 8	<b>KD073</b>	690	<b>2721.00</b>	<b>KD074</b>	1158	<b>4670.00</b>
8'3"	24'8"	x 16'6"	8	x 8	<b>KD077</b>	878	<b>3736.00</b>	<b>KD078</b>	1677	<b>7039.00</b>
12'3"	12'8"	x 8'4"	4	x 8	<b>KD083</b>	730	<b>3312.00</b>	<b>KD084</b>	977	<b>4415.00</b>
12'3"	16'8"	x 12'6"	4	x 8	<b>KD071</b>	997	<b>4110.00</b>	<b>KD072</b>	1465	<b>6065.00</b>
12'3"	24'8"	x 16'6"	8	x 8	<b>KD075</b>	1273	<b>5585.00</b>	<b>KD076</b>	2072	<b>8625.00</b>

TYPE C - 4 SIDES

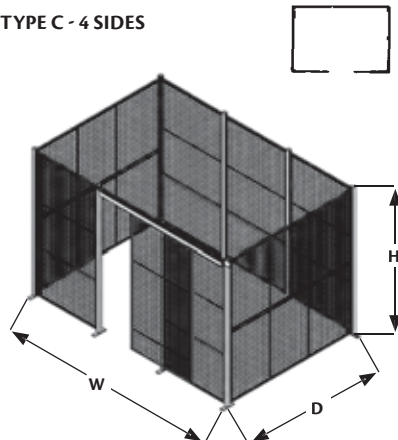

Unit Height	Overall Wall Size		Standard Sliding Door Size		Without Roof			With Roof		
	W	x D	W'	x H'	Model No.	Wt. lbs.	Price /Each	Model No.	Wt. lbs.	Price /Each
8'3"	12'8"	x 8'4"	4	x 8	<b>KD101</b>	688	<b>2702.00</b>	<b>KD102</b>	923	<b>3818.00</b>
8'3"	16'8"	x 12'6"	4	x 8	<b>KD089</b>	912	<b>3533.00</b>	<b>KD090</b>	1368	<b>5403.00</b>
8'3"	24'8"	x 16'6"	8	x 8	<b>KD093</b>	1190	<b>4883.00</b>	<b>KD094</b>	1975	<b>8093.00</b>
12'3"	12'8"	x 8'4"	4	x 8	<b>KD099</b>	996	<b>4156.00</b>	<b>KD100</b>	1231	<b>5272.00</b>
12'3"	16'8"	x 12'6"	4	x 8	<b>KD087</b>	1330	<b>5430.00</b>	<b>KD088</b>	1786	<b>7300.00</b>
12'3"	24'8"	x 16'6"	8	x 8	<b>KD091</b>	1740	<b>7079.00</b>	<b>KD092</b>	2525	<b>10294.00</b>

## PERIMETER GUARDS

- Create your own barrier guards with two styles to choose from: 2" x 2" welded wire mesh or 2" square tube
- Both feature a unique 49-1/2" overall height, and are easily installed
- Posts are constructed of 2" square tube with 5/16" base plate with holes for anchoring to floor
- Hardware to attach add-on sections is included
- Safety yellow or Kleton blue finish



Mesh style

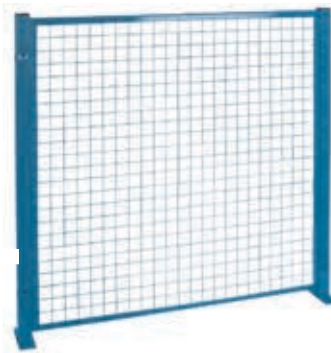

Tubular style perimeter guards

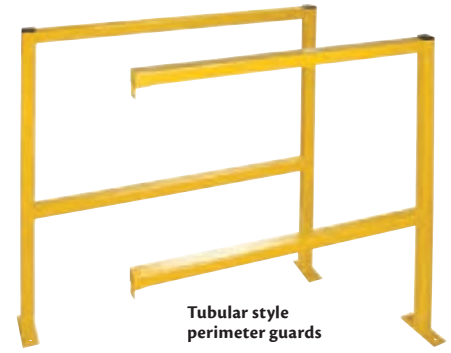

### MESH STYLE KITS

Description	Dimensions W" x H"	Wt. lbs.	Blue Model No.	Price /Each	Yellow Model No.	Price /Each
Starter Section	48 x 48	46	KH945	209.00	RL848	299.00
Add-On Section	48 x 48	34	KH946	159.00	RL849	230.00
Starter Section	96 x 48	65	KH947	259.00	RL850	355.00
Add-On Section	96 x 48	53	KH948	199.00	RL851	299.00

**Note:** Includes assembly fasteners, floor anchors and post caps

### MESH STYLE INDIVIDUAL COMPONENTS

Description	Dimensions W x H	Wt. lbs.	Blue Model No.	Price /Each	Yellow Model No.	Price /Each
Mesh Panel	4' x 4'	20	KD036	105.00	KD130	105.00
Mesh Panel	8' x 4'	39	KD037	180.00	KD131	180.00
Post Universal	49-1/2" H	13	KH861	49.40	KD129	49.40
Post Universal	99" H	22	KD053	79.95	KH860	79.95

### HARDWARE REQUIRED

Model No.	Description	Price /Each
KD001	Floor Anchors (Two per Post)	0.68
MMH262	5/16" x 3" Carriage Bolt (Four per Frame)	0.30
GM332	5/16" Hex Nut (One Nut for Each MMH262)	0.04
KD116	Post Caps (One per Post)	1.90

## BOLLARDS

- Protect your warehouse equipment, as well as high traffic areas with these heavy-duty steel bollards
- 4" x 4" square tube welded to an 8" x 8" x 1/2" steel base, complete with four 3/4" diameter holes for anchoring to floor
- Safety yellow powder coated finish



Model No.	Height"	Wt. lbs.	Price /Each
KD125	24	30	179.00
KH857	36	40	209.00
KD126	48	50	215.00

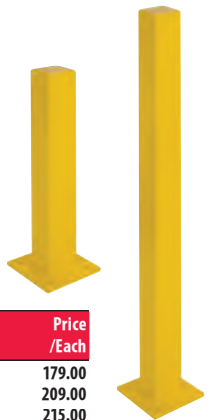

## UPRIGHT PROTECTOR

- Protects industrial racking from damaging impacts that cause unsafe conditions
- Made from 1/4" thick steel
- 4 pre-drilled holes made for 1/2" anchors (not included)
- Safety yellow powder coated finish



Model No.	W"	O.A. Dimensions x D" x H"	Wt. lbs.	Price /Each
KH858	7	x 7 x 12	12	46.95
RB925	7	x 7 x 18-1/4	15	63.95



### TUBULAR STYLE

Model No.	Description	Dimensions W" x H"	Wt. lbs.	Price /Each
KD132	Starter Section	48 x 49-1/2	45	255.00
KD133	Add-On Section *	46 x 49-1/2	32	225.00
KD134	Starter Section	96 x 49-1/2	66	339.00
KD135	Add-On Section *	94 x 49-1/2	53	315.00

\*Hardware to attach add-on section is included

### HARDWARE REQUIRED

Model No.	Description	Price /Each
KD001	Floor Anchors (2 per post)	0.68

## SAFETY GUARDS

- Protect your equipment and personnel from accidental damage and injury with these low profile safety guards
- 4" x 4" square tube welded to an 8" x 8" x 1/2" base, complete with four 3/4" diameter holes for anchoring to floor
- Colour: Safety yellow powder coat finish

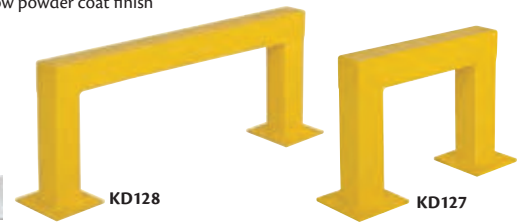

Model No.	Dimensions W" x H"	Wt. lbs.	Price /Each
KD127	24 x 18	65	419.00
KH855	36 x 18	75	515.00
KD128	48 x 18	85	485.00
KD136	24 x 42	95	545.00
KD856	36 x 42	110	669.00
KD139	48 x 42	115	599.00

## FLOOR ANGLE GUARD RAILS

- Floor angle guide rail helps keep traffic away from racking and shelving, walls, storage areas, offices, and other work areas
- The sturdy 5" H x 3" W x 1/4" D angle iron comes with holes to anchor to the floor
- Protectors can be customized to any other lengths and/or depths required
- Floor anchors not included
- Overall Width: 3"
- Overall Height: 5"
- Colour: Safety Yellow
- Material: Steel
- All welded construction



Model No.	Overall Length"	Wt. lbs.	Price /Each
RN065	48	26	119.00
RN066	60	33	135.00
RN067	120	66	249.00

# ENCLOSURES & GUARDS

## EDGEHALT® LADDER SAFETY GATE

- Provide top- and mid-rail protection, minimizing the chances of a fall from elevated platforms, mezzanines, or ladderways
- Adjustable up to 10"
- Slam-Proof™ technology creates a controlled and soft close
- Adjustable spring torque allows adjustability on how fast the gate closes
- Includes standard mounting hardware for round pipe (up to 2" O.D.) or square tubing (up to 2" x 2" O.D.)
- Gates can also be match-drilled directly to existing wall or railing system
- Tested to the OSHA, ANSI, and Canadian COHS standards, and exceeds the loading requirement by two times (OSHA 1910.29; OSHA 1910.28; ANSI A1264.1-2017; ANSI A14.3; Canada COHS SOR-86-304 Part I)
- Springs (tested to over 1 million cycles) are guaranteed by the manufacturer for the life of the gate



Model No.	Mfg. No.	Width"	Finish	Price /Each
MP709	LSG-1520-PCY	15 - 20	Powder Coated Yellow	602.00
MP710	LSG-2030-PCY	20 - 30	Powder Coated Yellow	614.00
MP711	LSG-3040-PCY	20-7/830 - 40	Powder Coated Yellow	657.00
MP712	LSG-4050-PCY	40 - 50	Powder Coated Yellow	867.00
MP713	LSG-1520-GAL	15-20	Hot-Dipped Galvanized Yellow	770.00

Model No.	Mfg. No.	Width"	Finish	Price /Each
MP714	LSG-2030-GAL	20-30	Hot-Dipped Galvanized	794.00
MP715	LSG-3040-GAL	30-40	Hot-Dipped Galvanized	818.00
MP716	LSG-4050-GAL	40-50	Hot-Dipped Galvanized Yellow	939.00
MP717	LSG-1520-3045W	15-20	304 Stainless Steel Seal Welded	1468.00
MP718	LSG-2030-3045W	20-30	304 Stainless Steel Seal Welded	1541.00
MP719	LSG-3040-3045W	30-40	304 Stainless Steel Seal Welded	1830.00
MP720	LSG-4050-3045W	40-50	304 Stainless Steel Seal Welded	1950.00

## INDUSTRIAL SAFETY GUARD RAILS

- Modular design allows you to customize your guard rail system to meet your specific needs
- Durable powder coated safety yellow finish for better visibility
- Overall Width: 3"
- Overall Height: 12"
- Colour: Safety Yellow
- Material: Steel

KI237



Model No.	Overall Length"	Nominal Length"	Price /Each
KI237	19	24	109.00
KI238	31	36	129.00
KI239	43	48	139.00
KI240	55	60	159.00
KI241	67	72	185.00
KI242	79	84	215.00
KI243	91	96	225.00
KI244	103	108	235.00
KI245	115	120	245.00

## GUARD RAIL POSTS

- Modular design allows you to customize your guard rail system to meet your specific needs
- Durable powder coated safety yellow finish for better visibility
- Mounting hardware and plastic cap included, floor anchors and guard rails sold separately
- Overall Length: 5"
- Overall Width: 5"
- Colour: Safety Yellow
- Material: Steel

KI246



Model No.	Description	Overall Height"	Price /Each
KI246	Simple	17	145.00
KI247	Double	44	225.00

## RACKING AISLE PROTECTORS

- Prevent collision damage to shelving/racking from fork lifts, pallet trucks or other in-plant vehicle accidents
- Corner wraps are 16" high with an angle of 5" H x 3" W x 1/4" D with holes for anchoring to the floor
- Protectors can be customized to any other lengths and/or depths required
- Floor anchors not included • Overall Width: 3"
- Overall Height: 16" • Colour: Safety Yellow
- Material: Steel • All welded construction

Model No.	Description	Overall Length"	Fits Racking Uprights	Price /Each
RN059	Single Wrap - Left	50	42" W	239.00
RN060	Single Wrap - Right	50	42" W	239.00
RN061	Single Wrap - Left	56	48" W	249.00
RN062	Single Wrap - Right	56	48" W	249.00
RN063	Double Wrap	47	42" W	359.00
RN064	Double Wrap	53	48" W	395.00

## PALLET RACK BACK GUARDS

Back guards help prevent accidents by keeping pallets and their contents from falling off the back of the rack. These guards increase safety where pedestrian pathways are behind the rack.

- Constructed using a 10-gauge frame, and 2" x 2", 10-gauge wire mesh with stiffeners
- Available in a variety of sizes to fit most pallet rack configurations
- Guard brackets are designed to fit almost any style of rack
- Durable safety yellow finish
- Hardware not included

KD131



ML231



Create a pallet rack back guard designed for your application

1. Choose one or a combination of back guard panels to create the required width and length

Model No.	Dimensions'	Weight lbs.	Price /Each
KH926	1 x 4	10	115.00
KH914	2 x 4	12	77.60
KH930	3 x 4	20	175.00
KD130	4 x 4	23	105.00
KD131	8 x 4	45	180.00

2. Choose a mounting bracket that provides the required depth
  - Minimum of four brackets required

Model No.	Dimensions"	Weight lbs.	Price /Each
ML231	4 x 6	2	23.90
ML232	4 x 9	2	26.50
ML233	4 x 12	3	26.50

### 3. Hardware required

- For each additional panel, add: 2 x GM332 and 2 x MMH254  
 For each mounting bracket, add: 3 x MMP624 and 3 x GM332

RN063





## COLUMN PROTECTORS

- Protect your building's columns from damaging bumps by moving vehicles
- Octagon configuration for more rebounding ability
- 100% rust proof
- Flexible deflection design
- Easy to assemble
- Nylon fasteners (included) for breakaway ability make these extremely versatile
- Protect columns under virtually any condition and temperature down to 0°F
- Colour: Yellow
- Dimensions: 23-1/2" L x 23-1/2" W x 39-1/2" H
- Material: Linear low density polyethylene (LLDPE)
- Weight: 42 lbs.



Model No.	Inside Opening"	Opening Shape	Description	Price /Each
RN047	6 x 6	Square	Fits square or round columns up to 6" sq.	580.00
RN048	8 x 8	Square	Fits square or round columns from 6" sq. to 8" sq.	580.00
RN049	9 Dia.	Round	Fits round columns up to 9" sq.	580.00
RN050	10 x 10	Square	Fits square or round columns up to 10" sq.	580.00
RN051	8 x 10	Rectangular	Fits rectangular columns only 8" x 10"	580.00
RN052	12 x 12	Square	Fits square or round columns up to 12" sq.	580.00

## COLUMN PROTECTORS

- Affordable protection for warehouse and factory columns and beams
- Absorbs impact from tow motors, minimizing column, fork truck, and personnel damage and injury
- Blown-moulded (HDPE) protectors are resistant to most chemicals
- Feature key-lock to prevent slippage and assist with installation alignment
- Two halves attach with easy-to-install black straps (included)
- No tools required
- Colour: Yellow
- Material: High-density polyethylene (HDPE)



Model No.	Inside Opening"	Dimensions			Wt. lbs.	Price /Each		
		L"	x	W"	x	H"		
RN041	4-6	13	x	13	x	42	16	385.00
RN040	6 x 6	24	x	24	x	42	40	669.00
RN039	8 x 8	24	x	24	x	42	40	659.00
RN037	10 x 10	24	x	24	x	42	40	629.00
RN038	12 x 12	24	x	24	x	42	40	629.00

## SLIM COLUMN PROTECTOR

- Protect your building's columns from damaging bumps by moving vehicles
- Octagon configuration for more rebounding ability
- 100% rust proof
- Flexible deflection design
- Easy to assemble
- Nylon fasteners (included) for breakaway ability make these extremely versatile
- Protect columns under virtually any condition and temperature down to 0°F
- Slim column protectors are great for smaller beams such as mezzanine uprights
- Opening Shape: Square
- Dimensions L x W x H: 12" x 12" x 42"
- Colour: Yellow
- Material: Linear low density polyethylene (LLDPE)
- Weight: 17 lbs.



Model No.	Inside Opening"	Price /Each
M0036	3x3	369.00
M0037	4x4	369.00
M0038	5x5	369.00
M0039	6x6	369.00

## BOLLARDS

- Bollards can be used to protect work areas, racking and personnel both indoors and outdoors
- Black plastic caps are removable
- Includes pre-drilled mounting holes
- Powder coat paint finish
- Material: Steel



Model No.	Dimensions			Weight lbs.	Price /Each		
	L"	x	W"	x	H"		
KI293	4-1/2	x	4-1/2	x	36	22	125.00
KI294	4-1/2	x	4-1/2	x	42	26	145.00
KI295	4-1/2	x	4-1/2	x	48	29	165.00

## CORNER PROTECTORS

- Corner Protectors help prevent damage to walls in areas with forklifts, hand trucks and other warehousing traffic
- These guard high-visibility yellow
- Made with high density polyethylene (HDPE)
- Crack and chip resist
- Feature unique energy absorbing construction
- Anchors not included
- Can be mounted end to end
- **Sold in sets of 2 protectors**

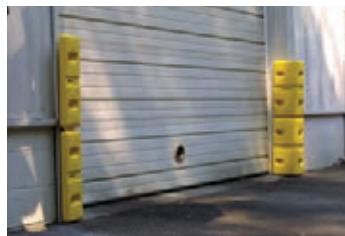

Model No.	Dimensions					Wt. lbs.	Price /Set
	L"	x	W"	x	H"		
KH994	10	x	6	x	21	10	229.00
KH995	10	x	6	x	42	20	359.00

## WALL PROTECTORS

- Wall Protectors help prevent damage to walls in areas with forklifts, hand trucks and other warehousing traffic
- These guard high-visibility yellow
- Made with high density polyethylene (HDPE)
- Crack and chip resist
- Feature unique energy absorbing construction
- Anchors not included
- Can be mounted end to end
- **Sold in sets of 2 protectors**



Model No.	Dimensions					Wt. lbs.	Price /Set
	L"	x	W"	x	H"		
KH996	42	x	2	x	6	8	275.00
KH997	42	x	2	x	10	14	305.00

# ENCLOSURES & GUARDS

## STEEL SAFETY BOLLARDS

- Bollards can be used both indoors and outdoors to protect work areas, racking and personnel
- Colour: Yellow



Model No.	Overall Length"	Overall Width"	Overall Height"	Price /Each
KA102	4.5	4.5	24	129.00
KA105	5.5	5.5	24	139.00
KI293	4.5	4.5	36	125.00
KA106	5.5	5.5	36	195.00
KI294	4.5	4.5	42	145.00
KA107	5.5	5.5	42	195.00
KI295	4.5	4.5	48	165.00
M0017	6.5	6.5	48	325.00

## FOLD-DOWN STEEL BOLLARDS

- Unique fold-down design ideal for use in parking control and security
- 42" high when in upright position and 4" high when collapsed
- Can be locked in raised position with the use of a padlock (Not included)
- Base plate must be anchored to the ground (Anchors not included)
- Size: 1-3/4" Dia. (Outside) 42"H (Extended)

Model No. KH818 - Galvanized  
Price/Each \$195.00



Model No. KH819 - Powder Coat Yellow  
Price/Each \$189.00



## SOFT EDGE FLEXIBLE WARNING & PROTECTION SYSTEMS

- Tough, flexible polyurethane foam extrusions reduce the risk of personnel injury at high risk corners
- When applied to machinery, furnishings and walls, Soft Edge prevents impact damages by absorbing even the hardest of impacts
- Highly visible black and yellow markings offer permanent warning in dangerous areas
- Simple "peel-away" adhesive installation on grease-free surfaces
- Excellent temperature range from -40 °C to 100 °C

Knuffi

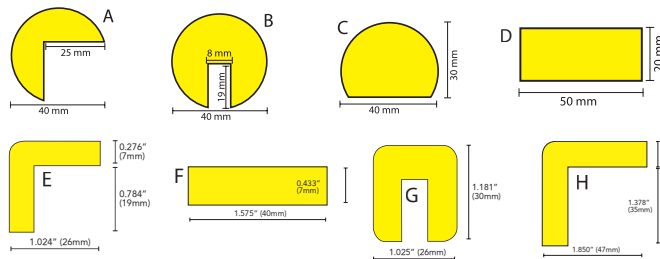

Style	1 Metre Model No.	Price /Each	5 Metres Model No.	Price /Each
A	KH866	44.50	KH865	235.00
B*	KH868	46.50	KH867	245.00
C	KH870	46.90	KH869	249.00
D	KH872	60.90	KH871	319.00
E	KH952	46.90	KH953	249.00
F	KH954	44.90	KH955	239.00
G*	KH956	48.50	KH957	255.00
H	KH958	63.90	KH959	335.00

\* Does not have peel-away adhesive. Held by pressure fit.

## CORNER ACCESSORIES

Makes a neat corner where two foam bumper guards protection profiles meet.



MN379



MN380



MN381



MN382

Knuffi

Model No.	Description	Price /Each
MN379	2 Way - Use with Profile A	43.50
MN380	3 Way - Use with Profile A	45.90
MN381	2 Way - Use with Profile E	39.50
MN382	3 Way - Use with Profile E	43.50
MN383	2 Way - Use with Profile H	47.50
MN384	3 Way - Use with Profile H	49.90

## POLYETHYLENE BOLLARD COVERS

- Enhance and protect the appearance of your steel bollards
- Reduce maintenance; avoid scraping and painting each spring
- Constructed of 1/8" UV stable polyethylene for durability
- Easy installation with patented GripperTabs™ included
- Colour: Safety yellow with reflective red tape or high visibility red with white reflective tape, for great visibility day or night
- 5-year warranty against fading and cracking



Yellow Model No.	Red Model No.	Fits Bollard Diameter"	Fits Bollard Length"	Wt. lbs.	Price /Each
KH806	KH836	4-1/2	52	7	105.00
KH808	KH838	4-1/2	64	9	119.00
KH809	KH839	6-5/8	52	8	125.00
KH810	KH840	6-5/8	60	9	139.00
KH811	KH841	6-5/8	72	10	159.00

## ROTABIN STORAGE UNITS

- Revolving units allow for greater accessibility and visibility
- Shelves sit securely on ball bearings held with a solid steel pin
- Each shelf rotates smoothly and independently

### TO ORDER:

- 1) Measure available floor space to determine Rotabin shelf diameter that will not intrude on aisles.
- 2) Determine number of Rotabin shelves required by matching the unit height with the available storage height.
- 3) Select the appropriate Rotabin unit: 17", 28", 34", 44" or 58" diameter units

**DURHAM MFG®**  
Est. 1922

### 28" DIAMETER

- 6 permanent 14 1/2" wide compartments per shelf
- Model CA221 dividers can be inserted on 1" centres
- Capacity: 500 lbs. per shelf

### 34" DIAMETER

- 5 permanent 21" wide compartments per shelf
- Optional removable pans for 34" diameter units allow for easy parts inventory, restocking, transporting to work area or to get weighted
- Capacity: 500 lbs. per shelf

Model No.	No. of Shelves	No of Pans*	Unit Height"	Wt. lbs.	Price /Each
<b>UNIT ONLY 28" (PANS NOT AVAILABLE)</b>					
CA193	5	-	38	125	1793.00
CA194	6	-	41	144	2029.00
CA195	7	-	47	163	2214.00
CA196	8	-	53	182	2502.00
CA197	9	-	60	201	2725.00
CA198	10	-	66	220	2939.00
<b>UNIT ONLY 34" (PANS NOT INCLUDED)</b>					
CA225	4	60	35	135	1799.00
CA226	5	75	43	162	2106.00
CA227	6	90	50	188	2454.00
CA228	7	105	66	215	2761.00
CA229	8	120	66	240	3068.00
<b>GREY PANS FOR 34" UNIT</b>					
CA258	-	-	-	-	15.50

\*Max number of Pans (Pans Not included)

CA229



### 44" DIAMETER

- Designed for storage of larger quantities of small parts or fasteners, or heavier parts
- Scoop compartment design is manufactured from one piece of heavy gauge steel, with dividers welded in place
- 5 compartments per shelf, with a 625-lb. capacity each shelf
- Grey enamel finish



Model No.	No. of Shelves	Unit Height"	Wt. lbs.	Price /Each
CA262	3	34	154	2679.00
CA263	4	45	196	3494.00
CA264	5	56	238	4104.00
CA265	6	67	284	5139.00

### 17" DIAMETER

- Can be used on counter tops or workbenches
- Each shelf has 4 permanent compartments
- Can have up to 16 compartments per shelf using model CA192 adjustable dividers
- Curved bottom facilitates removal of small parts

CA188



Model No.	No. of Shelves	Unit Height"	Wt. Capacity per Shelf lbs.	Wt. lbs	Price /Each
CA188	4	18 1/2	60	25	469.00
CA189	6	26 1/8	60	34	779.00
CA191	10	42 1/8	60	52	1039.00

Model No.	Description	Wt. lbs.	Price /Each
CA192	Adjustable Divider	0.02	7.09

## MULTI-PURPOSE BINS

- Removable vertical dividers allow creation of multi-width compartments
- Scoop shelves allow contents to be removed easily
- Keyhole slots provide for wall mounting
- 36 bins (3 7/8" W x 4 5/8" D x 3 3/4" H)
- 23 3/4" W x 4 3/4" D x 23 3/4" H
- Weight: 25 lbs.
- Powder coat grey finish

Model No. CA161  
Price/Each \$229.00



**DURHAM MFG®**  
Est. 1922



# BULK CONTAINERS



## BULK STACKING CONTAINERS

- Heavy-duty all-welded construction
- Mesh containers use 2" x 2" x 10 gauge wire mesh
- All containers use a 13-gauge corrugated sheet steel base
- 2" x 2" x 3/16" angle posts
- 4-way fork truck entry with 4" under-clearance
- Available with one drop gate or fully enclosed sides
- Height: 24" inside, 30" overall
- Stackable up to 5 high
- Other sizes are available
- Painted durable Kleton blue



CF449



CF453



CF457



CF450

**KLETON**

Model No.	Description	Capacity lbs.	Width"	Length"	Weight lbs.	Price /Each
<b>MESH CONTAINERS</b>						
CF449	Fully Enclosed	3000	34.5	40.5	125	585.00
CF450	One Drop Gate	3000	34.5	40.5	130	675.00
CF451	Fully Enclosed	3000	40.5	48.5	150	659.00
CF452	One Drop Gate	3000	40.5	48.5	160	779.00
<b>SHEET CONTAINERS</b>						
CF453	Fully Enclosed	3500	34.5	40.5	150	875.00
CF454	One Drop Gate	3500	34.5	40.5	150	999.00
CF455	Fully Enclosed	3500	40.5	48.5	185	1015.00
CF456	One Drop Gate	3500	40.5	48.5	185	1149.00
<b>CORRUGATED CONTAINERS</b>						
CF457	Fully Enclosed	4500	34.5	40.5	160	999.00
CF458	One Drop Gate	4500	34.5	40.5	160	1125.00
CF459	Fully Enclosed	4500	40.5	48.5	195	1149.00
CF460	One Drop Gate	4500	40.5	48.5	195	1285.00

## OPEN MESH CONTAINERS

- Rugged construction ensures long lasting, trouble free service
- 3/4" - 13 gauge expanded metal mesh panels
- 2 half drop gates
- Four-way fork truck access
- 4 1/4" underclearance
- Overall dimensions: 34 1/2" x 40 1/2" x 32 1/4"
- Stackable up to 5 high
- 15 cu.ft. capacity
- Deck capacity: 2500 lbs. mesh deck, 3000 lbs. sheet metal deck
- Blue enamel finish



CF468

**M & P TOOL**

Model No.	Style	Wt. lbs.	Price /Each
CA397	Mesh deck	105	479.00
CA398	Sheet metal deck	114	519.00
CA368	Cup Foot	0.72	6.92

## COLLAPSIBLE WIRE CONTAINER

- Welded, mesh wire maximizes visibility and ventilation
- Can be stacked up to 4 high
- Features a drop gate for easy access to products
- Equipped with 4 caster plates that are compatible with all Kleton casters
- Capacity: 4000 lbs.
- Overall Depth: 48"
- Overall Height: 42"
- Overall Width: 40"
- No. of Drop Gates: 1
- Collapsed height: 9"

**Model No. CG021**  
**Price/Each \$565.00**



**KLETON**

## NESTING FORKLIIFT BIN

- Storage Capacity: 24 cu.ft.
- Load Capacity: 1200 lbs.
- Barrel type nesting stops
- Nest when empty
- Colour: Blue
- Dimensions: 42" W x 48" D x 30" H

**Model No. CF775**  
**Price/Each \$485.00**

### LID

- Dimensions: 48" L x 42" W

**Model No. CF776**  
**Price/Each \$272.00**



**TECHSTAR**  
**PLASTICS INC.**

## COLLAPSIBLE BULK CONTAINER

- Drop gates knock-down with ease
- Quickly collapsed, folded, and stacked for convenient transportation
- Lid sold separately
- Colour: Grey
- Max. Height: 39.4"
- Max. Length: 47.2"
- Max. Width: 39.4"
- No. of Drop Gates: 2
- Material: High-density polyethylene (HDPE)
- Weight Capacity: 2000 lbs.
- Folded Height: 14.2"
- Weight 121.3 lbs. (55 kg)

**Model No. CF862**  
**Price/Each \$675.00**

### LID

- For use with Kleton collapsible bulk container
- Material: High-density polyethylene (HDPE)
- Colour: Light Grey
- Weight: 13.2 lbs. (6 kg)

**Model No. CF863**  
**Price/Each \$99.95**



**KLETON**

## HEAVY-DUTY BULK TOTE® CONTAINER

- Ideal for metal stampings and other heavy, dense components
- Unique fork opening at the top of the container offers the ability to present the short side to the assembly line
- Wide stacking ridge allows for secure load stacking
- Reusable and long-lasting durability bulk container
- Handheld and collapsible container replaces wire baskets, steel tubs or wood/corrugated packaging
- Capacity: 500 lbs.
- Dimensions: 16" W x 30" D x 19.2" H
- Colour: Black
- Material: High-density polyethylene (HDPE)
- Maximum Loaded Stack Static: 4 high
- Maximum Loaded Stack Dynamic: 2 high
- Pallet Entry: 4-Way
- Total Empty Weight: 30 lbs.

**Model No. CF934**  
**Price/Each \$512.00**

**ORBIS**



## TOOLS THAT MEASURE UP!

**AURORA**  
TOOLS

# SMALL PARTS STORAGE

## STEEL STORAGE BINS

- Pigeonhole type steel storage bin units organise small parts
- Best suited where space is limited and organization is crucial
- Produced of prime cold rolled steel
- Fully welded, will not warp, twist or sag
- Fully hemmed label holders provide adequate space for content identification
- Each divider is hemmed in a tear drop design to avoid sharp edges
- Doors with padlock attachment and bases to raise units are available with most models
- All units are 33 3/4" wide and are available in depths of 12" or 8 1/2"
- 12" deep units feature a 45° slope front for easy removal of parts
- Finished in grey powder coat

**DURHAM MFG®**  
Est. 1922



CA151



CA152

Perfect for organising your shop - can be filled with just about anything!



CA154



CA136



CA157  
Base for storage bins



CA133



CA141  
Door for storage bins

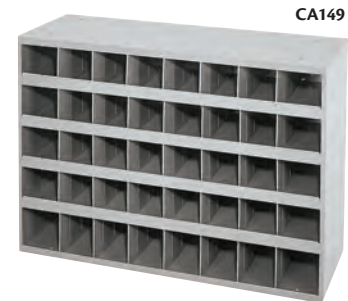

CA149

Model No.	Dimensions				No. of Bins	Bin Dimensions				Wt. lbs.	Price /Each	Base Model No.	Price /Each	Door Model No.	Price /Each	
	W"	x	D"	x	H"	W"	x	D"	x	H"						
<b>12" DEEP STORAGE BINS</b>																
CA133	33 3/4	x	12	x	11 1/2	4	x	11 7/8	x	5 1/8	25	235.00	CA157	135.00	-	
CA134	33 3/4	x	12	x	19 1/4	5 3/8	x	11 7/8	x	6 3/8	38	339.00	CA157	135.00	-	
CA136	33 3/4	x	12	x	23 7/8	5 3/8	x	11 7/8	x	5 1/2	44	349.00	CA157	135.00	-	
CA149	33 3/4	x	12	x	23 7/8	4	x	11 7/8	x	4 1/2	50	379.00	CA157	135.00	-	
CA151	33 3/4	x	12	x	42	5 3/8	x	11 7/8	x	5 1/2	71	549.00	CA157	135.00	CA141	219.00
CA152	33 3/4	x	12	x	42	4 7/8	x	11 7/8	x	5 1/8	75	589.00	CA157	135.00	CA141	219.00
CA154	33 3/4	x	12	x	42	4	x	11 7/8	x	4 1/2	80	595.00	CA157	135.00	CA141	219.00
<b>8 1/2" DEEP STORAGE BINS</b>																
CA150	33 3/4	x	8 1/2	x	22 1/4	4	x	8 3/8	x	4 1/2	50	345.00	CA158	155.00	-	
CA155	33 3/4	x	8 1/2	x	42	4	x	8 3/8	x	4 1/2	85	549.00	CA158	155.00	CA141	219.00



## INDUSTRIAL DRAWER CABINETS

- Provide a rugged modular storage system for small parts
- Select from a range of drawer capacities from 9 to 96 drawers per cabinet
- Various drawer sizes are available including drawer heights of 2 3/4" and 3 1/2", and drawer depths of 11 1/8" and 17"
- Each drawer includes 2 adjustable dividers and full width handles
- Drawer sides are slotted to hold dividers



A. Drawer Cabinets, Base included

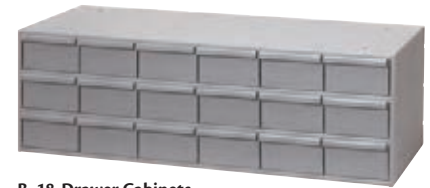

B. 18-Drawer Cabinets



C. 24-Drawer Cabinets



D. 9-Drawer Cabinets



E. 30-Drawer Cabinets

**DURHAM MFG®**  
Est. 1922



Type	Model No.	No. of Drawers	Drawer Size				Cabinet Height"	Wt. lbs.	Price /Each	Replacement Drawers	Price /Each	
			W"	x	D"	x	H"					
A	FI356	30	5 3/8	x	11 1/4	x	3 1/2	26 7/8	107	1335.00	CD661	23.90
A	CA936	48	5 3/8	x	11 1/8	x	2 3/4	33 3/4	176	1229.00	CA921	21.50
A	FI357	60	5 3/8	x	11 1/4	x	3 1/2	48	194	1999.00	CD661	23.90
A	CA939	72	5 3/8	x	11 1/8	x	2 3/4	48 1/8	238	1555.00	CA921	21.50
A	FI358	90	5 3/8	x	11 1/4	x	3 1/2	69 1/8	281	2669.00	CD661	23.90
A	CA941	96	5 3/8	x	11 1/8	x	2 3/4	62 1/2	300	1895.00	CA921	21.50
B	CA924	18	5 3/8	x	11 1/4	x	2 3/4	10 7/8	50	309.00	CA921	21.50
B	CA925	18	5 3/8	x	11 1/4	x	3 1/2	12 7/8	87	395.00	CD661	23.90
B	CA926	18	5 3/8	x	17	x	3 1/2	12 7/8	75	515.00	CA923	37.90
C	CA930	24	5 3/8	x	11 1/4	x	2 3/4	14 3/8	60	399.00	CA921	21.50
C	CA932	24	5 3/8	x	17	x	3 1/2	17	96	659.00	CA923	37.90
D	CA942	9	5 3/8	x	11 1/4	x	2 3/4	10 7/8	28	195.00	CA921	21.50
E	CA934	30	5 3/8	x	11 1/4	x	3 1/2	21 1/8	87	619.00	CD661	23.90
E	CA935	30	5 3/8	x	17	x	3 1/2	21 1/8	118	809.00	CA923	37.90
-	CA946		Extra Divider for 2 3/4" H Drawer						0.1	1.69	-	-
-	CA947		Extra Divider for 3 1/2" H Drawer						0.1	1.69	-	-

## HEAVY-DUTY 2-SIDED MOBILE CARTS/WORK STATIONS

- Two rigid and two swivel casters with locking brakes
- Sturdy tubular handle allows ease of mobility
- Rubber tray mat provides safe, secure, non-skid work surface
- Finished in rust and acid resistant grey powder coat
- Heavy-duty casters, capacity of 1000 lbs.
- Shipped fully welded

**DURHAM MFG®**  
Est. 1922



- Two 12-compartment bins back-to-back
  - Overall dimensions: 34" W x 24" D x 32" H
  - Ship weight: 139 lbs.
- Model No. CD330**  
**Price/Each \$1445.00**



- Two 40-compartment bins back-to-back
  - Overall dimensions: 34" W x 24" D x 32" H
  - Ship weight: 159 lbs.
- Model No. CD349**  
**Price/Each \$1575.00**



Front



Back

- One lockable 4-compartment storage cabinet
  - One storage bin with 12 compartments
  - 12 easily dividable pull out storage drawers, six oneach side
  - Overall dimensions: 34" W x 24" D x 34" H
  - Ship weight: 180 lbs.
- Model No. MO070**  
**Price/Each \$1849.00**

# SMALL PARTS STORAGE



## MODULAR SMALL PARTS STORAGE UNITS

- Unit is ideal for organization and storage of multipurpose small parts and variety of sized components
- Not included: Mounting/fastening hardware (requires 12 x 1/4" nuts & bolts)
- Steel construction
- Grey powder-coated finish



FN371



FN372



FN373



FN375



FN374



FN377



FN376



FN378

### (1) 72-HOLE BOLT BIN, (1) 18-DRAWER CABINET & (1) ELEVATED BASE

- 33-3/4" W x 12-1/4"D x 58-5/8" H
- No. of Drawers: 18
- Weight: 123 lbs.
- Drawer Cabinet Dimensions: 33-3/4" W x 11-5/8" D x 10-7/8" H
- Bolt Bin Dimensions: 33-3/4" W x 12" D x 42" H
- Base Dimensions: 33-3/4" W x 12-1/4" D x 5-3/4" H

Model No. FN371 Price/Each \$909.00

### (3) LARGE SLIDE RACKS, (12) LARGE COMPARTMENT BOXES & (1) ELEVATED BASE

- 20-3/8" W x 16" D x 60-1/8" H
- No. of Drawers: 12
- Weight: 48 lbs.
- Large Slide Rack Dimensions: 20" W x 15-3/4" D x 15" H
- Large Compartment Box Dimensions: 18" W x 12" D x 3" H
- Base Dimensions: 20-9/16" W x 16-1/8" D x 15" H

Model No. FN372 Price/Each \$1397.00

### (1) 40-HOLE BOLT BIN, (1) 18-DRAWER CABINET & (1) ELEVATED BASE

- 33-3/4" W x 12-1/4"D x 40-1/2" H
- No. of Drawers: 18
- Weight: 105 lbs.
- Drawer Cabinet Dimensions: 33-3/4" W x 11-5/8" D x 10-7/8" H
- Bolt Bin Dimensions: 33-3/4" W x 12" D x 23-7/8" H
- Base Dimensions: 33-3/4" W x 12-1/4" D x 5-3/4" H

Model No. FN374 Price/Each \$680.00

### (2) LARGE SLIDE RACKS, (8) LARGE COMPARTMENT BOXES, (1) SINGLE-DOOR UTILITY CABINET, (1) 40-HOLE BOLT BIN & (1) ELEVATED BASE

- 33-3/4" W x 12-1/4"D x 59-5/8" H
- No. of Drawers: 8
- Weight: 118 lbs.
- Large Slide Rack Dimensions: 20" W x 15-3/4" D x 15" H
- Large Compartment Box Dimensions: 18" W x 12" D x 3" H
- Utility Cabinet Dimensions: 13-3/4" W x 12-3/4" D x 30" H
- Bolt Bin Dimensions: 33-3/4" W x 12" D x 23-7/8" H
- Base Dimensions: 33-3/4" W x 12-1/4" D x 5-3/4" H

Model No. FN375 Price/Each \$1530.00

### (1) 40-HOLE BOLT BIN, (2) 24-DRAWER CABINETS & (1) ELEVATED BASE

- 33-3/4" W x 12-1/4"D x 58-3/8" H
- No. of Drawers: 48
- Weight: 124 lbs.
- Bolt Bin Dimensions: 33-3/4" W x 12" D x 23-7/8" H
- Drawer Cabinet Dimensions: 33-3/4" W x 11-5/8" D x 14-3/8" H
- Base Dimensions: 33-3/4" W x 12-1/4" D x 5-3/4" H

Model No. FN377 Price/Each \$1096.00

### (1) SMALL SLIDE RACK, (4) SMALL COMPARTMENT BOXES, (1) 9-DRAWER CABINET, (1) 42-HOLE BOLT BIN & (1) ELEVATED BASE

- 33-3/4" W x 12-1/4"D x 59" H
- No. of Drawers: 13
- Weight: 122 lbs.
- Small Slide Rack Dimensions: 15-1/4" W x 11-3/4" D x 11-1/4" H
- Large Compartment Box Dimensions: 13-1/8" W x 9-1/4" D x 2" H
- Drawer Cabinet Dimensions: 17-1/4" W x 11-5/8" D x 10-7/8" H
- Bolt Bin Dimensions: 33-3/4" W x 12" D x 42" H
- Base Dimensions: 33-3/4" W x 12-1/4" D x 5-3/4" H

Model No. FN378 Price/Each \$1036.00

### (1) 42-HOLE BOLT BIN, (1) 18-DRAWER CABINET & (1) ELEVATED BASE

- 33-3/4" W x 12-1/4"D x 58-5/8" H
- No. of Drawers: 18
- Weight: 115 lbs.
- Drawer Cabinet Dimensions: 33-3/4" W x 11-5/8" D x 10-7/8" H
- Bolt Bin Dimensions: 33-3/4" W x 12" D x 42" H
- Base Dimensions: 33-3/4" W x 12-1/4" D x 5-3/4" H

Model No. FN373 Price/Each \$820.00

### (1) DOUBLE-DOOR UTILITY CABINET, (1) 40-HOLE BOLT BIN & (1) ELEVATED BASE

- 33-3/4" W x 12-1/4"D x 55-1/2" H
- No. of Drawers: 0
- Weight: 99 lbs.
- Utility Cabinet Dimensions: 33-3/4" W x 12" D x 23-7/8" H
- Bolt Bin Dimensions: 33-3/4" W x 12" D x 23-7/8" H
- Base Dimensions: 33-3/4" W x 12-1/4" D x 5-3/4" H

Model No. FN376 Price/Each \$786.00

**DURHAM MFG<sup>®</sup>**  
Est. 1922

## COMPARTMENT STEEL SCOOP BOXES

- Manufactured of prime cold rolled steel
- Choose from between 8 to 32 fixed compartment boxes
- Small box dimension: 13 3/8" x 9 1/4" x 2"
- Large box dimension: 18" x 12" x 3"
- Durable polypropylene plastic dividers have rounded scoops, making it easy to remove small parts
- Finished in rust and acid resistant grey powder coat
- All models have covers designed to stay open
- See chart below for drawer configurations



**DURHAM MFG**  
Est. 1922

### FIXED COMPARTMENT CONFIGURATIONS, ORDER BY NUMBER OF COMPARTMENTS

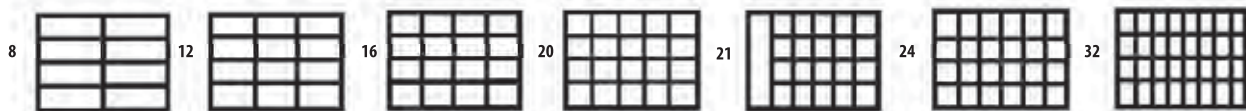

Number of Compartments	LARGE BOXES 18" X 12" X 3"			SMALL BOXES 13 1/4" X 9 1/4" X 2"		
	Model No.	Wt. lbs.	Price /Each	Model No.	Wt. lbs.	Price /Each
8	-	-	-	CB032	4	36.50
12	CA986	8	59.90	CB015	4	39.90
16	CA989	8	59.90	CB017	4	39.90
20	CA992	8	59.90	CB023	4	39.90
21	CA995	8	59.90	CB026	4	38.90
24	CA997	8	59.90	CB029	4	39.90
32	CB002	8	59.90	-	-	-

## COMPARTMENT BOX CABINETS

- Carriages extend 100% of the drawers depth for easy access to parts
- Flexibility of removable drawers and a large selection of drawer configurations
- Drawer cabinet may be mounted on a raised base

- Cabinets are available for both the small and large drawer sizes
- Boxes and base are sold separately
- Optional locking hinge (CB037/CB038) prevents boxes from sliding out during transport

**DURHAM MFG**  
Est. 1922

Model No.	Dimensions			For Box	Drawer Capacity	Wt. lbs.	Price /Each
	W"	x D"	x H"				
CG146	20	x 15 15/16	x 8 3/16	Large	2	-	235.00
CA965	20	x 15 3/4	x 15	Large	4	34	309.00
FI361*	20	x 15 3/4	x 15	Large	4	75	389.00
CG154	15 9/16	x 11 7/8	x 11 5/16	Small	4	-	235.00
CG155	15 9/16	x 11 7/8	x 15 9/16	Small	6	-	325.00
CB037	Optional Locking Hinge for CG154			-	-	-	15.90
CB038	Optional Locking Hinge for CA965 and CG155			-	-	-	18.50

\*Heavy-duty



Cabinet and boxes sold separately

## ADJUSTABLE COMPARTMENT BOXES

- Adjustable drawers provide the added flexibility of arranging your drawers according to your changing needs
- Removable dividers can be "slotted" into place or removed altogether



**DURHAM MFG**  
Est. 1922

Model No.	Dimensions			Description	Wt. lbs.	Price /Each
	W"	x D"	x H"			
CA977	18	x 12	x 3	Large	8	62.90
CA979	13 3/8	x 9 1/4	x 2	Small	4	40.90

## CABINET BASES

- Cabinet bases raise your cabinet/drawer combination 12" off of the floor or workbench
- Models are available to adapt to both small and large drawer size cabinets



**DURHAM MFG**  
Est. 1922

Model No.	Overall Dimensions				For Box	Wt. lbs.	Price /Each
	W"	x D"	x H"	x H"			
CA980	20 3/8	x 16	x 15 1/8		Large	13	125.00
CG157	15 1/2	x 12 1/4	x 15		Small	12	119.00



# SMALL PARTS STORAGE

## STEEL PARTS CABINETS

- New design allows 98% use of drawer space to store larger tools or materials
- Housed in all-welded galvanised steel cabinet
- Label with clear plastic cover and divider included with every drawer
- Plastic tabs (except model CF323) and drawer stoppers allow for full extension without risk of spilling
- Grey enamel finish

### KPC-HD HEAVY-DUTY PARTS CABINETS

- Drawer size: 6.5" W x 14.8" D x 4.1" H
- Heavy-duty ABS beige drawers
- Heavy-duty steel shelves provide extra durability



Model No.	No. of Drawers	Dimensions W" x D" x H"	Wt. lbs.	Price /Each
CF323	30	34.6 x 15.7 x 34.6	119	995.00

#### REPLACEMENT PARTS

Model No.	Description	Price /Each
CF324	Drawer	28.95
CF546	Black Divider	3.00
CF343	Label Cover	2.95
CF344	Label	0.40



CF323

### KPC-100 PARTS CABINETS

- Drawer size: 6.4" W x 11.3" D x 2.7" H
- Heavy-duty ABS beige drawers



Model No.	No. of Drawers	Dimensions W" x D" x H"	Wt. lbs.	Price /Each
CF283	12	23 x 11.4 x 13.8	28	445.00
CF285	36	23 x 11.4 x 36.9	60	625.00

#### REPLACEMENT PARTS

Model No.	Description	Price /Each
CF286	Drawer	21.10
CF545	Black Divider	2.15
CF287	Clear Divider	1.60
CF341	Label Cover	0.40
CC310	Label	0.25

CF283



CF285



### KPC-200 PARTS CABINETS

- Drawer size: 5.9" W x 9.8" D x 3.3" H
- Heavy-duty ABS beige drawers



Model No.	No. of Drawers	Dimensions W" x D" x H"	Wt. lbs.	Price /Each
CA889	30	21.3 x 10.4 x 36.9	58	595.00

#### REPLACEMENT PARTS

Model No.	Description	Price /Each
CF481	Drawer	11.95
CF548	Black Divider	1.50
CF341	Label Cover	0.40
CC310	Label	0.25

CA889



## STEEL PARTS CABINETS

- New design allows 98% use of drawer space to store larger tools or materials
- Housed in all-welded galvanised steel cabinet
- Label with clear plastic cover and divider included with every drawer
- Plastic tabs (except model **CF323**) and drawer stoppers allow for full extension without risk of spilling
- Grey enamel finish

### KPC-300 PARTS CABINETS

- Drawer size: 5.9" W x 9.8" D x 1.6" H
- Clear polystyrene drawers

**KLETON**

Model No.	No. of Drawers	Dimensions W" x D" x H"	Wt. lbs.	Price /Each
CA890	60	21.3 x 10.4 x 36.9	60	815.00

### REPLACEMENT PARTS

Model No.	Description	Price /Each
CB984	Drawer	7.95
CF549	Black Divider	3.00
CF024	Label Cover	2.95
CF340	Label	0.49

### KPC-400 PARTS CABINETS

- Drawer size: 4.7" W x 8.6" D x 2.7" H
- Heavy-duty ABS beige drawers

**KLETON**

Model No.	No. of Drawers	Dimensions W" x D" x H"	Wt. lbs.	Price /Each
CF298	16	23.1 x 8.7 x 13.8	24	315.00
CA891	24	17.3 x 8.7 x 25.6	33	375.00
CA892	48	22.6 x 8.7 x 36.9	58	555.00
CD440*	48	22.6 x 10.8 x 36.9	66.8	895.00

\* Comes with locking door

### REPLACEMENT PARTS

Model No.	Description	Price /Each
CB985	Drawer	10.95
CF550	Black Divider	0.70
CF341	Label Cover	0.40
CC310	Label	0.25

### KPC-500 PARTS CABINETS

- Drawer size: 3.5" W x 8.6" D x 2.7" H
- Clear polystyrene drawers

**KLETON**

Model No.	No. of Drawers	Dimensions W" x D" x H"	Wt. lbs.	Price /Each
CF305	16	18.3 x 8.7 x 13.8	21	309.00
CF304	15	13.9 x 8.7 x 16.3	22	259.00
CC453	32	18.1 x 8.7 x 25.6	31	425.00
CC454	60	22.6 x 8.7 x 36.9	68	725.00

### REPLACEMENT PARTS

Model No.	Description	Price /Each
CC455	Drawer	6.35
CF551	Black Divider	0.95
CF341	Label Cover	0.40
CC310	Label	0.25



CA890



CA892

CD440

CA891

CF298



CC454

CC453

CF305

CF306

CF304

# SMALL PARTS STORAGE

## STEEL PARTS CABINETS

- New design allows 98% use of drawer space to store larger tools or materials
- Housed in all-welded galvanised steel cabinet
- Label with clear plastic cover and divider included with every drawer

- Plastic tabs and drawer stoppers allow for full extension without risk of spilling
- Grey enamel finish

### KPC-600 PARTS CABINETS

- Drawer size: 3.5" W x 8.6" D x 2.2" H
- Clear polystyrene drawers



Model No.	No. of Drawers	Dimensions W" x D" x H"	Wt. lbs.	Price /Each
CF311	18	13.9 x 8.7 x 16.3	19	239.00
CF312	20	18.3 x 8.7 x 13.8	21	279.00
CF313	25	23.1 x 8.7 x 13.8	27	325.00
CF314	40	18.3 x 8.7 x 25.3	40	449.00
CF315	75	23.1 x 8.7 x 36.9	66	825.00

### REPLACEMENT PARTS

Model No.	Description	Price /Each
CF552	Black Divider	1.00
CF341	Label Cover	0.40
CC310	Label	0.25

### KPC-700 PARTS CABINETS

- Drawer size: 4.7" W x 8.6" D x 2.2" H
- Clear polystyrene drawers



Model No.	No. of Drawers	Dimensions W" x D" x H"	Wt. lbs.	Price /Each
CF319	30	17.5 x 8.7 x 25.3	40	425.00
CF320*	60	23.1 x 8.7 x 36.9	71	665.00

\*Wall mounting compatible using holes on backside of cabinet (Hardware not included)

### REPLACEMENT PARTS

Model No.	Description	Price /Each
CF321	Drawer	8.30
CF553	Black Divider	0.95
CF341	Label Cover	0.40
CC310	Label	0.25



## HEAVY-DUTY INDUSTRIAL CAROUSEL DRAWER CABINETS

- Create your customized carousel cabinet
- Each level accommodates 4 parts cabinets with same height
- For a multiple tier cabinet (maximum 3 tiers), you require add-on-shelves and threaded rods as per the following: 1 add-on-shelf model **CF402** for each level of cabinets 14" rod required for each level of **CF312** or **CF305** cabinets 25" rod required for each level of **CC453** or **CF314** cabinets
- Rotational base allows for 800-lb. capacity
- All-welded 11-gauge steel base
- Durable Kleton grey enamel finish



Model No.	Description	Dimensions W" x D" x H"	Wt. lbs.	Price /Each
<b>3 TIER CABINETS KITS</b>				
CF405	192 Drawers	18.3 x 8.7 x 48	392	3080.00
CF406	240 Drawers	18.3 x 8.7 x 48	407	3192.00
CF407	384 Drawers	18.3 x 8.7 x 80	497	4383.00
CF408	480 Drawers	18.3 x 8.7 x 80	600	4377.00

### COMPONENTS

Model No.	Description	Dimensions W" x D" x H"	Wt. lbs.	Price /Each
CF401	Base and Top Cover	27.5 x 27.5 x 4	80	655.00
CF402	Add-on Shelf	27.5 x 27.5 x 1	18	92.50
CF403	Threaded Rod - 14"	0.375 x - x 14	1	38.50
CF404	Threaded Rod - 25"	0.375 x - x 25	1.5	44.90
CF305	Parts Cabinet - 16 Drawers	18.3 x 8.7 x 14	21	309.00
CF312	Parts Cabinet - 20 Drawers	18.3 x 8.7 x 14	21	279.00
CC453	Parts Cabinet - 32 Drawers	18.3 x 8.7 x 25	31	425.00
CF314	Parts Cabinet - 40 Drawers	18.3 x 8.7 x 25	40	449.00

CF408



### Includes:

- Qty: 12 - **CF314** - Cabinet - 40 drawers
- Qty: 1 - **CF401** - Base and Top Cover
- Qty: 2 - **CF404** - Threaded Rod 25"
- Qty: 2 - **CF402** - Add-on Shelf



## COMPACT POLYPROPYLENE COMPARTMENT BOXES

- High strength, oil resistant polypropylene, boxes with covers fitted with heavy-duty reinforced hinges
- Hinges have a special "stop" feature which allows the cover to remain in open position
- Covers overlap on all sides of the bottom tray
- Two snap latches assure secure closure
- Stackable



### COMPARTMENT BOX CABINETS

- All steel grey powder coat cabinet holds five plastic compartment boxes
- Bolt holes permit stacking and keyhole slots are furnished for wall mounting
- Convenient carry handle

**DURHAM MFG**  
Est. 1922



Model No.	Overall Dimensions				No. of Compartments	Compartment Dimensions				Wt. lbs.	Price /Each
	W"	x	D"	x H"		W"	x	D"	x H"		
CB513	11	x	6 3/4	x 13/4	6	13/4	x	6 1/4	x 19/16	0.7	7.99
CB509	11	x	6 3/4	x 13/4	12	13/4	x	3 1/8	x 19/16	0.7	7.99
CB511	11	x	6 3/4	x 13/4	18	13/4	x	2 1/16	x 19/16	0.7	7.99
CB507	13 1/8	x	9	x 25/16	6	2	x	8 1/2	x 2	0.8	13.90
CB501	13 1/8	x	9	x 25/16	12	2	x	4 3/32	x 2	0.8	13.90
CB503	13 1/8	x	9	x 25/16	18	2	x	(6) 4 3/4 (12)	x 2	0.8	13.90
CB505	13 1/8	x	9	x 25/16	24	2	x	2	x 2	0.8	13.90

### COMPARTMENT BOX RACKS (BOXES NOT INCLUDED)

Model No.	Description	Dimensions				Wt. lbs.	Price /Each
		W"	x	D"	x H"		
CB631	Small Box Rack	11 1/4	x	6 3/4	x 10 3/4	7	86.50
CB632	Large Box Rack	13 1/2	x	9 1/8	x 13 1/4	11	115.00

## COMPARTMENT CASE

- High strength, high quality polypropylene case
- Translucent lid allows for quick view of contents
- Snap latch ensures a secure closure
- Removable dividers allow for different configurations



**AURORA**  
TOOLS

Model No.	Overall Dimensions			No. of Compartments	Wt. lbs.	Price /Each
	W"	x	D" x H"			
CF333	10 3/4	x	5 3/8 x 1 1/2	Variable up to 17	0.7	8.95
TLZ117	5 3/8	x	5 3/8 x 1 3/8	Variable up to 9	0.3	6.25

## DRAWER CABINET

- Durable, high-impact polypropylene frame with clear polypropylene drawers and bins
- Heavy-duty reinforced construction
- See-through drawers come with dividers
- Pre-drilled holes on rear side allow easy wall mounting
- Drawer stops prevent bins from falling out
- Colour: Black
- Material: Plastic



**QUANTUM™**  
STORAGE  
SYSTEMS

Model No.	Mfg. No.	Height"	Width"	Depth"	No. of Drawers	Wt. lbs.	Price /Each
CG061	PDC-12BK	10-1/4	10-1/2	6-1/4	12	3	46.50
CG062	PDC-18BK	18-3/4	15	6-1/4	18	5	105.00
CG063	PDC-22BK	10	19-1/2	6-1/4	22	5	77.90
CG064	PDC-39BK	18-3/4	15	6-1/4	39	6	109.00
CG065	PDC-60BK	18-3/4	15	6-1/4	60	7	109.00
CG066	PDC-930BK	18-3/4	15	6-1/4	39	6	109.00

# SMALL PARTS STORAGE

## HEAVY-DUTY TILT BINS

- Extremely durable ABS plastic housing and drawer body
- Transparent polystyrene front window for easy viewing
- Conveniently connects to each other with grooved channels on top, bottom and sides
- Shake resistant design prevents drawers from opening on their own
- Keyholes on back for wall mounting applications
- Colour: Black and Grey



**KLETON**

Model No.	No. of Drawers	Bin Dimensions					Cabinet Dimensions					Price /Each
		W"	x	D"	x	H"	W"	x	D"	x	H"	
CF471	8	2-3/4	x	3-1/4	x	3-5/8	11-3/4	x	2-3/4	x	7-7/8	34.75
CF472	6	3-11/16	x	4	x	4-5/8	11-3/4	x	3-1/2	x	9-3/4	36.75
CF473	5	4-1/2	x	4-7/8	x	5-1/2	23-1/2	x	4	x	5-7/8	42.95
CF474	4	5-5/8	x	6-3/8	x	7-1/2	23-1/2	x	5-1/2	x	7-7/8	67.50

## MOBILE TILT BIN RACKS

- Heavy-duty steel frame
- Durable powder coat paint finish on galvanized steel
- 3" swivel casters with brake
- Single or double sided use
- Overall dimensions: 26-1/4" W x 22" D x 57-1/2" H
- Colour: Grey

### MOUNTING CHANNEL CF476 FOR MOBILE TILT BIN RACK

- Takes up to six mounting channels per side
- CF473 tilt bins take up to eight mounting channels per side
- CF471 and CF472 take 2 bin units per level per side



SEE PLASTIC BINS FOR CF502 MOUNTING CHANNEL ON PAGES 204-205



**KLETON**

Model No.	Description	Bin Units Included	Price/Each
CF477	Single Sided	2 of each CF471, CF472, CF473, CF474	895.00
CF478	Double Sided	4 of each CF471, CF472, CF473, CF474	1380.00
CF475	Cart Only*	-	475.00
CF476	Mounting Channel for Heavy-Duty Tilt Bins	-	29.95
CF502	Mounting Channel for Plastic Bins	-	25.95

\* Mounting channels and bins not included

## TILT BINS UNIT

- One-mold set of 21 tilt bin compartments
- Blue-coloured handles are impact resistant and non-breakable
- Sleek design keeps small and medium-sized parts organized, sorted and easy-to-find
- Overall width: 23-5/8"
- Overall depth: 3-5/8"
- Overall height: 11-1/6"
- No. of bin compartments: 21
- Weight: 0.8 lbs.
- Housing colour: Grey
- Bin colour: Clear w/blue handle

Model No. CG076  
Mfg. No. QTB669GY  
Price/Each \$109.00



**QUANTUM STORAGE SYSTEMS**

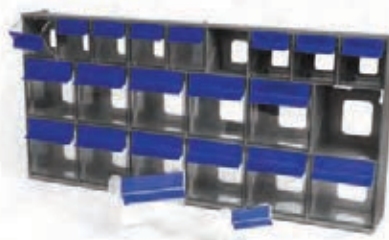

## TIP-OUT BIN MODULAR STORAGE SYSTEMS

- Each bin has a slot for labeling
- Bins can be completely removed for replenishing or cleaning
- Uniform widths of 23.6" (for units of 2 to 9 bins)
- Can be used free-standing or with stands and pedestals
- Transparent compartments tip out for easy access and viewing
- Colour: Beige or Grey



### TILT BINS

Model No.			Bin Dimensions				Cabinet Dimensions					Wt.	Price	
Beige	Grey	Mfg. No.	W"	x	D"	x	H"	W"	x	D"	x	H"	lbs.	/Each
CB552	CB553	QTB309	23/16	x	13/4	x	2 1/2	23 5/8	x	2 1/2	x	3 1/8	2.0	32.50
CB549	CB550	QTB306	3 1/2	x	2 5/8	x	3 3/4	23 5/8	x	3 5/8	x	4 1/2	3.0	38.50
CB546	CB547	QTB305	4 1/4	x	3 3/4	x	5 3/4	23 5/8	x	5 1/4	x	6 1/2	5.0	63.50
CB543	CB544	QTB304	5 5/8	x	5	x	7 1/2	23 5/8	x	6 5/8	x	8 1/8	7.0	89.50
CB540	CB541	QTB303	7 3/8	x	5 7/8	x	8 5/8	23 5/8	x	7 3/4	x	9 1/2	9.0	98.50
CB977	CB978	QTB302	11 1/16	x	8 7/8	x	13 5/8	23 5/8	x	11 7/8	x	13 7/8	14	219.00
CB975	CB976	QTB301	11 1/16	x	8 7/8	x	13 5/8	11 3/16	x	11 7/8	x	13 7/8	7	155.00
CB573	Two discs and two screws set (1 needed for each bin)												6.59	

## TIP-OUT BIN STANDS



Assembly Required



**FRAME ONLY: BINS NOT INCLUDED**

Model No.	Description	Dimensions			Bin Quantity Table QTB Series Bins						Price /Each		
		W"	x	H"	302	303	304	305	306	309			
<b>FLOOR STANDS</b>													
CB562	48" 1 Sided	23 5/8	x	8	x	52	3	5	6	7	11	16	445.00
CB563	70" 1 Sided	23 5/8	x	8	x	75	5	7	8	10	15	23	539.00
<b>WALL FRAMES</b>													
CB559	48"												159.00
CB561	70"												215.00
CB573*	Disc & Screw Set (2 disks/2 screws)												6.59

\*Disc & screw set required for each bin cabinet to be mounted on a frame



# RACKING & SHELVING

## MAGNUM BIN SHELVING UNITS

- Dimensions: 42" W x 18" D x 76" H
- Capacity: 480 lbs. per shelf
- Shipped knocked down



### SERIES QMS531

- 27 QMS531 open hopper bins
- 19 3/4" L x 12 3/8" W x 5 7/8" H
- 10 heavy-duty grey enamel shelves

### SERIES QMS532

- 21 QMS532 open hopper bins
- 19 3/4" L x 12 3/8" W x 7 7/8" H
- 8 heavy-duty grey enamel shelves



CF187

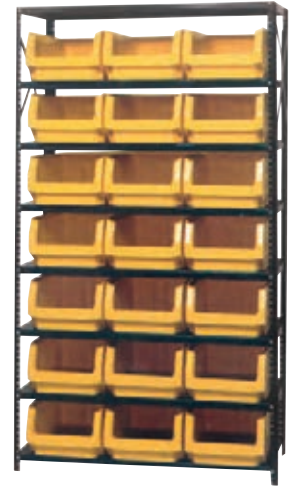

CF074

Model No.				Description	Price /Each
Red	Blue	Yellow	Green		
<b>QMS532 SERIES BIN SHELF UNIT</b>					
CF072	CF073	CF074	CF075	Starter	1247.00
CF089	CF090	CF091	CF092	Add-on	1164.00
<b>QMS531 SERIES BIN SHELF UNIT</b>					
CF188	CF185	CF186	CF187	Starter	1472.00
CF784	CF785	CF786	CF787	Add-on	1388.00

## MAGNUM BIN SHELVING UNITS

- Dimensions: 42" W x 18" D x 76" H
- Capacity: 480 lbs. per shelf
- Shipped knocked down



### SERIES QMS516

- 4 QMS543 red, 3 QMS533 blue, 6 QMS532 yellow and 3 QMS531 blue open hopper bins
- 7 heavy-duty grey enamel shelves

### SERIES QMS533

- 15 QMS533 open hopper bins
- 19 3/4" W x 12 3/8" D x 11 7/8" H
- 6 heavy-duty grey enamel shelves



CF189

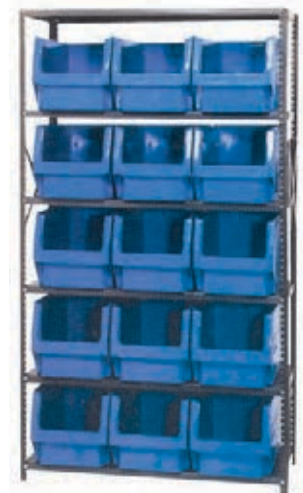

CF081

Model No.				Description	Price /Each
Red	Blue	Yellow	Green		
<b>QMS533 SERIES BIN SHELF UNIT</b>					
CF080	CF081	CF082	CF083	Starter	961.00
CF097	CF098	CF099	CF100	Add-on	878.00
<b>QMS516 SERIES BIN SHELF UNIT</b>					
CF189*	-	-	-	Starter	1146.00
CF788*	-	-	-	Add-on	1062.00

\* Mixed colours

## OPEN HOPPER STORAGE SHELF UNITS

### QUS239 SERIES

- 28 QUS239 Series bins
- 11" L x 8 1/4" W x 7" H
- 8 heavy-duty grey enamel shelves
- 36" W x 12" D x 76" H
- Cap.: 630 lbs. per shelf
- Shipped knocked down

### QUS240 SERIES

- 28 QUS240 Series bins
- 14 3/4" L x 8 1/4" W x 7" H
- 8 heavy-duty grey enamel shelves
- 36" W x 12" D x 76" H
- Cap.: 630 lbs. per shelf
- Shipped knocked down



CF118



CF126

Model No.						Description	No. of Shelves	Price /Each
Black	Blue	Yellow	Red	Ivory	Green			
<b>QUS239 SERIES BINS SHELF UNIT</b>								
CF176	CF118	CF119	CF120	CF121	CF122	Starter	8	880.00
CF180	CF140	CF141	CF142	CF143	CF144	Add-On	8	797.00
<b>QUS240 SERIES BINS SHELF UNIT</b>								
CF178	CF123	CF124	CF125	CF126	CF127	Starter	8	993.00
CF182	CF150	CF151	CF152	CF153	CF154	Add-On	8	910.00

## WIDE SPAN SHELVING WITH JUMBO PLASTIC BINS

- Ideal for storing supplies in warehouses or shops
- No bolt shelving system can be built quickly and easily
- 12-gauge steel posts and 13-gauge beams
- Shelf levels include 5/8" particleboard decking and required tie bars
- Capacity is 800 lbs. per shelf evenly distributed
- Offered configurations include three levels with 12 bins and four levels with 16 bins
- Plastic bin dimensions: 15 1/2" W x 25" D x 13" H
- Assembly required



RL984



RL989

**KLETON**



Model No.	Shelving Size			No. of Shelves	No. of Bins	Colour	Price /Each
	W" x D" x H"	x	x				
RL984	66 x 18 x 60	x	60	3	12	Red	1311.00
RL985	66 x 18 x 60	x	60	3	12	Blue	1311.00
RL986	66 x 18 x 60	x	60	3	12	Green	1311.00
RL987	66 x 18 x 60	x	60	3	12	Yellow	1311.00
RL988	66 x 18 x 60	x	60	3	12	Red, Blue, Yellow	1311.00
RL980	66 x 18 x 72	x	72	4	16	Red	1589.00
RL981	66 x 18 x 72	x	72	4	16	Blue	1589.00
RL982	66 x 18 x 72	x	72	4	16	Green	1589.00
RL983	66 x 18 x 72	x	72	4	16	Yellow	1589.00
RL989	66 x 18 x 72	x	72	4	16	Red, Blue, Yellow, Green	1589.00

## GIANT STACK CONTAINER SHELF UNITS

- Includes 10 QGH700 storage bins and heavy-duty grey enamel shelves
- 42" W x 18" D x 76" H
- Capacity: 500 lbs. per shelf
- Shipped knocked down



Model No.					Description	No. of Shelves	Price /Each
Grey	Blue	Ivory	Black	Red			
CF056	CF057	CF059	CF060	CF066	Starter	6	883.00
CF061	CF062	CF064	CF065	CF067	Add-On	6	799.00

## OPEN HOPPER STORAGE SHELF UNITS

### QUS 250 SERIES

- 14 QUS 250 Series bins 14 3/4" L x 16 1/2" W x 7" H
- 8 heavy-duty grey enamel shelves
- 36" W x 12" D x 76" H
- Cap.: 630 lbs. per shelf
- Shipped knocked down

### QUS 240 & 230 SERIES

- 8 QUS 240 Series bins 14 3/4" L x 8 1/4" W x 7" H
- 36 QUS 230 Series bins 11" L x 5 1/2" W x 5" H
- 9 heavy-duty grey enamel shelves
- 36" L x 12" D x 76" H
- Cap.: 630 lbs. per shelf
- Shipped knocked down

Model No.						Description	No. of Shelves	Price /Each
Black	Blue	Yellow	Red	Ivory	Green			
<b>QUS 250 SERIES BINS SHELF UNIT</b>								
CF177	CF128	CF129	CF130	CF131	CF132	Starter	8	804.00
CF181	CF145	CF146	CF147	CF148	CF149	Add-On	8	721.00
<b>QUS 240 &amp; 230 SERIES BINS SHELF UNIT</b>								
CF179	CF133	CF134	CF135	CF136	CF137	Starter	9	955.00
CF183	CF175	CF155	CF156	CF157	CF158	Add-On	9	872.00



CF132



CF135

# BINS

## HI-STAK PLASTIC BINS

- Innovative stacking design allows for greater visibility and easier access to contents
- Distortion-free from -40°C to 120°C
- Unaffected by oil, alkaline and most acids
- Ideal in production or for store display
- Included with each bin: I.D. card with clear plastic shield, four riser legs and connector clip



Inclined faceplate with removable label and protector

KLETON



1" riser legs increase loading capacity and stability



Stackable using built-in feet



Connector clip allows for back-to-back mounting



Built-in extrusions allow side-by-side interlock

Model No.				Outside Dimensions				Wt. lbs.	Price /Each	Faceplate & Label Model No.	Price /Each	Replacement Legs Model No.	Price /Package
Blue	Yellow	Green	Red	W"	x D"	x H"							
CB260	CB261	CC234	CC242	4 13/16	x 7 1/8	x 3 3/16	0.10	3.65	CC441	0.95	CC263	2.65	
CB262	CB263	CC235	CC243	5 7/8	x 9 13/16	x 4 11/16	0.15	6.50	CC441	0.95	CC263	2.65	
CB264	CB265	CC236	CC244	8 3/16	x 14	x 6 3/16	0.35	12.25	CC443	0.75	CC437	3.95	
CC239	CC240	CC237	CC245	7 7/8	x 17 11/16	x 7	0.55	23.50	CC443	0.75	CC437	3.95	
CB266	CB267	CC238	CC246	11 13/16	x 17 11/16	x 7	0.60	28.50	CC443	0.75	CC437	3.95	

Note: Add 1 inch to overall height when stacking on legs.

## WIRE MESH STACK & HANG BINS

- Innovative mesh design offers nickel-chrome finish and a 3/8" x 3/8" grid pattern allowing complete visibility of bin contents
- This unique mesh pattern provides a dust and dirt free storage environment
- Mesh Bins feature a rear hanger that allows them to hang from any louvered wall panel or rail system
- Optional side hangers allow bin to stack one on top of the other
- The open hopper design allows for easy picking while allowing visual access to stored contents
- Material: Wire mesh
- Colour: Nickel-chrome
- Capacity: 100 lbs. Hang/175 lbs. Stack

SEE PAGE 206 FOR LOUVERED PANELS

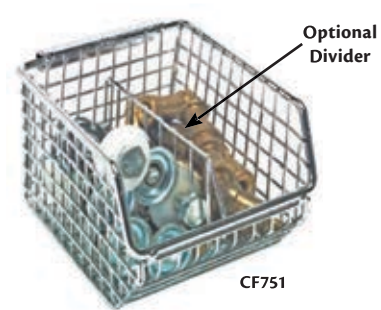

CF751



CF755



QUANTUM™ STORAGE SYSTEMS

### BINS

Model No.	Mfg. No.	Outside Dimensions				Inside Dimensions				Price /Each	Model No.	Mfg. No.	Price /Each
		W"	x D"	x H"	W"	x D"	x H"						
CF751	QMB510C	4 1/4	x 5 1/4	x 3	4	x 4 3/4	x 2 7/8	28.90	CF766	DMB510C	8.89		
CF752	QMB520C	4 1/4	x 7 1/4	x 3	4	x 6 3/4	x 2 7/8	30.50	CF767	DMB520C	10.90		
CF753	QMB530C	5 1/2	x 10 3/4	x 5	5 1/2	x 10 1/4	x 4 3/4	43.90	CF768	DMB530/535C	14.90		
CF754	QMB535C	11	x 10 3/4	x 5	10 3/4	x 10 1/4	x 4 3/4	60.90	CF768	DMB530/535C	14.90		
CF755	QMB539C	8	x 10 1/2	x 7	7 1/2	x 10	x 6 3/4	54.50	CF769	DMB539C	15.50		
CF756	QMB540C	8	x 14 1/2	x 7	7 2/5	x 14	x 6 3/4	64.90	CF770	DMB540/550C	18.50		
CF757	QMB550C	16 1/4	x 14 1/2	x 7	15 3/4	x 14	x 6 3/4	90.50	CF770	DMB540/550C	18.50		
CF758	QMB560C	11	x 18 1/2	x 10 1/8	10 5/8	x 18 1/16	x 10	125.00	CF771	DMB560/570C	24.90		
CF759	QMB570C	17 1/8	x 18 1/2	x 11 1/8	16 5/8	x 18 1/8	x 11	145.00	CF771	DMB560/570C	24.90		

### DIVIDERS

### SIDE HANGERS\*

Model No.	Mfg. No.	Description	Price /Each
CF760	HMB510C	For Bin CF751	6.19
CF761	HMB520C	For Bin CF752	6.39
CF762	HMB530/535C	For Bin CF753/CF754	7.19
CF763	HMB539C	For Bin CF755	7.69
CF764	HMB540/550C	For Bin CF756/CF757	7.39
CF765	HMB560/570C	For Bin CF758/CF759	8.69

\*Hangers sold per pair





## KLETON STACK & HANG BINS

- Designed to hang from bin racks, panels, rails and carts
- Bins reduce and control inventories, shorten assembly times and minimize parts handling
- Reinforced ribs, on both sides, prevent bins from spreading under loads
- Front, back and side grips for easy handling
- Stackable

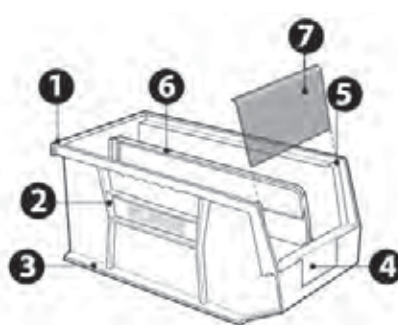
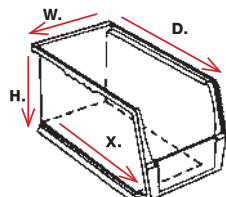
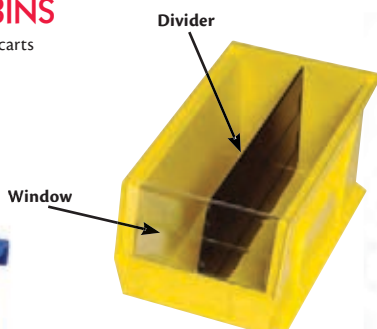

**KLETON**

1. Full width hanger supports bins when suspended from louvered panels or rails
2. Reinforced rib design adds strength and prevents spreading when stacked
3. Extra-wide ledges for secure stacking and stability
4. Large front label slots ideal for larger bar code scanning and content identification
5. Anti-slide stop prevents stacked bins from shifting forward
6. Optional dividers increase storage options
7. Optional windows maximize storage capacity, prevent spillage and protect parts from dust and dirt

Blue	Red	Yellow	Green	Black	Series	Outside Dimensions				Inside Dimensions				Bottom Depth X"	Load Cap. lbs.	Price /Each	Uses Divider	Price /Each	Uses Clear Window	Price /Each		
W"	x	D"	x	H"	W"	x	D"	x	H"	W"	x	D"	x	H"								
CF820	CF822	CF823	CF821	CF824	30210	4-1/8	x	5-3/8	x	3	3-7/16	x	4-3/4	x	2-13/16	4	10	1.99	CB825	1.15	-	
CF825	CF827	CF828	CF826	CF829	30220	4-1/8	x	7-3/8	x	3	3-7/16	x	6-3/4	x	2-13/16	6	10	2.39	CB826	1.26	-	
CF830	CF832	CF833	CF831	CF834	30230	5-1/2	x	10-7/8	x	5	4-3/8	x	10-1/4	x	4-3/4	9	30	6.19	CB829	2.69	CB814	2.79
CF835	CF837	CF838	CF836	CF839	30235	11	x	10-7/8	x	5	10	x	10-1/4	x	4-3/4	9	50	11.80	CB829	2.69	CB815	3.99
CF840	CF842	CF843	CF841	CF844	30239	8-1/4	x	10-3/4	x	7	6-9/16	x	10	x	6-3/4	8	50	12.90	CB830	3.39	CB818	3.59
CF845	CF847	CF848	CF846	CF849	30240	8-1/4	x	14-3/4	x	7	6-9/16	x	14	x	6-3/4	12	60	13.90	CB831	5.49	CB818	3.59
CF850	CF852	CF853	CF851	CF854	30250	16-1/2	x	14-3/4	x	7	14-3/4	x	14	x	6-3/4	12	75	20.50	CB831	5.49	CB819	8.39

## DIVIDERS

- Maximizes flexibility, keeps contents organized
- Allows for the separation of contents in bins
- Installed in a back to front position



**KLETON**

Model No.	Description	Dividers per Case	Price/Each
CB825	For 5-3/8" D x 3" H Bin	6	1.15
CB826	For 7-3/8" D x 3" H Bin	6	1.26
CB829	For 10-7/8" D x 5" H Bin	6	2.69
CB830	For 10-3/4" D x 7" H Bin	6	3.39
CB831	For 14-3/4" D x 7" H Bin	6	5.49

## CLEAR WINDOWS

- Crystal styrene window front increases bin capacity
- Provides quick view on bin contents
- Snaps quickly into place



**KLETON**

Model No.	Description	Windows per Case	Price/Each
CB814	5-1/2" W x 5" H	12	2.79
CB815	11" W x 5" H	6	3.99
CB818	8-1/4" W x 7" H	6	3.59
CB819	16-1/2" W x 7" H	6	8.39

## CLEAR COVER

- Provides high visibility and accessibility to bin contents
- Easy snap-in installation due to integrated hinge pins
- Clear covers protects from dust, dirt, and debris
- Can be used with dividers



**QUANTUM™ STORAGE SYSTEMS**

Model No.	Description	Covers per Case	Price/Each
CF855	For 5-3/8" D x 4-1/8" W x 3" H Bin	24	2.49
CF856	For 7-3/8" D x 4-1/8" W x 3" H Bin	24	4.19
CF857	For 10-7/8" D x 5-1/2" W x 5" H Bin	12	6.59
CF858	For 10-7/8" D x 11" W x 5" H Bin	6	9.99
CF859	For 10-3/4" D x 8-1/4" W x 7" H Bin	6	9.09
CF860	For 14-3/4" D x 8-1/4" W x 7" H Bin	12	9.19

## RECYCLED PLASTIC BINS

- Manufactured from recycled 100% post consumer, high density polyethylene
- Available in black only



**QUANTUM™ STORAGE SYSTEMS**

Model No.	Mfg. No.	Outside Dimensions				Price /Each	Dividers	Price /Each	
W"	x	D"	x	H"					
CC553	QUS210BR	4/18	x	5 3/8	x	3	1.79	CB825	1.15
CC554	QUS220BR	4/18	x	7 3/8	x	3	3.79	CB826	1.26
CC555	QUS230BR	5 1/2	x	10 7/8	x	5	9.49	CB829	2.69
CC558	QUS235BR	11	x	10 7/8	x	5	14.50	CB829	2.69
CC559	QUS239BR	8 1/4	x	10 3/4	x	7	16.50	CB830	3.39
CC560	QUS240BR	8 1/4	x	14 3/4	x	7	18.50	CB831	5.49
CC562	QUS250BR	16 1/2	x	14 3/4	x	7	25.90	CB831	5.49

# BINS

## METAL BIN SUPPORT RACKS

- Louvered bin panels can be wall-mounted, attached to back of shelving, mounted on benches, carts, inside cabinets, fastened to slotted angle components or used for service truck interiors
- Bins are easily removed, refilled and replaced
- Each heavy-duty panel is 16-gauge cold-rolled steel
- Slotted holes 3/4" L x 3/8" W at 6" centres simplify installation
- Kleton grey powder coated
- Installation Note:** Panels must be securely fastened to materials of adequate load bearing strength
- Each panel must be secured vertically at the centre

**KLETON**

**CF412**  
Bins not included

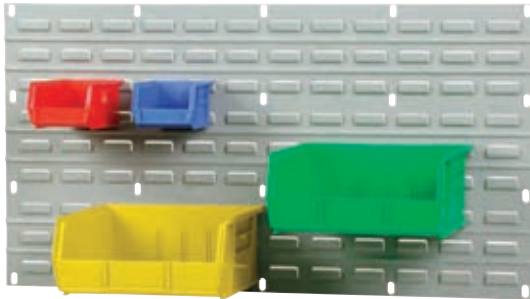

Model No.	Panel Size			Wt. lbs.	Price /Each
	W"	x	H"		
CF411	18	x	19	6	31.95
CF412	36	x	19	12	55.25

### BIN QUANTITY TABLE

Quantity of identical plastic bins that fit model CF412 panel

Combined Panel Height 35 3/4" Wide		Bin CF820	Bin CF825	Bin CF830	Bin CF835	Bin CF840	Bin CF845	Bin CF850	
1 Panel	=	19" H	32	32	18	9	8	8	4
2 Panels	=	37" H	72	72	36	18	18	16	8
3 Panels	=	55" H	104	104	54	27	28	28	14
4 Panels	=	73" H	144	144	72	36	36	36	18

For CF411 Panel, use 1/2 of bin quantities shown above.

## BIN CARTS

- All-welded bin cart
- Work surface made of 14-gauge steel
- Includes bolted on 5" non-marking casters and 2 louvered bin panels
- 1000-lb. capacity
- Durable Kleton blue finish



**CB365**



**CB367**

**KLETON**

Model No.	Description	Cart Dimensions				Wt. lbs.	Price /Each
		W"	x	D" x	H"		
CB365	Cart only	24	x	38 1/2 x	36 1/2	95	969.00

### CART & BIN COMBINATION

Blue	Red	Yellow	Green						
CB366	CB367	CB368	CB689	24	x	38 1/2 x	36 1/2	133	1218.00

### BINS SUPPLIED

Bin Qty	Bin Dimensions			
	W"	x	D" x	H"
16	8 1/4	x	14 3/4 x	7
4	16 1/2	x	14 3/4 x	7

## QUANTUM® LOUVERED PANEL

- Ideal for mounting plastic hanging or wire mesh bins
- All welded construction
- Resists to any build-up of dust or dirt
- Mounting clips are included and can be fastened to any surface
- Mounting screws sold separately as they differ based on the type of surface
- Bins Not Included

SEE PAGE 204 FOR WIRE MESH STACK+HANG BINS

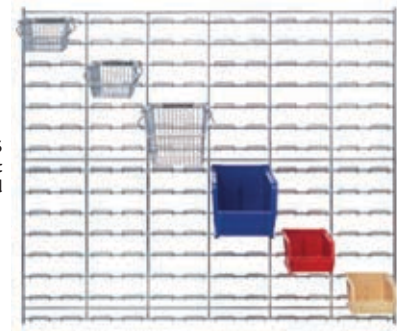

**CF995**  
Bins not included

**QUANTUM™ STORAGE SYSTEMS**

Model No.	Overall Dimensions			Price /Each
	W"	x	H"	
CF994	36	x	18	145.00
CF995	36	x	30	245.00
CF996	48	x	30	265.00

## DIRECT MOUNT CLIP

- Allows for louvered panel to be fastened to any surfaces such as wall, wood, concrete, and drywall
- Mounting screws sold separately as they differ based on the type of surface
- Qty/Pkg.: 4



Model No.	Price /Each
CF997	9.59

**QUANTUM™ STORAGE SYSTEMS**

## OFFSET MOUNT CLIP

- Allows for louvered panel to be mounted away from a wall surface
- Ideal for reaching behind the panel to clean
- Qty/Pkg.: 4



Model No.	Price /Each
CF998	11.90

**QUANTUM™ STORAGE SYSTEMS**

**MATRIX**  
INDUSTRIAL PRODUCTS

Maintain the ideal temperature in your workplace

## MOBILE BIN RACKS

- Ideal for transportation of small parts
- All-welded mobile bin rack
- Durable Kleton blue enamel finish



### RACK ONLY

Model No.	Description	Rack Type	Dimensions W" x D" x H"	Wt. lbs.	Price /Each
CB359	Rack only	Single	36 x 16 x 46-1/2	60	499.00
CB649	Rack only	Double	36 x 24 x 67-1/2	120	909.00

### RACK & BIN COMBINATION

Model No.				Rack Type	Dimensions W" x D" x H"	Wt. lbs.	Price /Each
Blue	Red	Yellow	Green				
CB650	CB651	CB652	CB681	Single	36 x 16 x 52	83	680.00
CB089	CB090	CB091	CB683	Double	36 x 24 x 63	187	1466.00

### BINS SUPPLIED WITH CART & BIN COMBINATION:

Bin Qty	Bin Dimensions			
	W"	x	D"	x H"
<b>SINGLE SIDED RACK</b>				
36	5 1/2	x	10 7/8	x 5
<b>DOUBLE SIDED RACK</b>				
32	4 1/8	x	5 3/8	x 3
16	4 1/8	x	7 3/8	x 3
24	5 1/2	x	10 7/8	x 5
16	8 1/4	x	14 3/4	x 7
8	16 1/2	x	14 3/4	x 7

## STATIONARY BIN RACKS

- Designed to be permanently installed to the floor
- All-welded stationary bin racks
- Constructed of 1 1/4" square tube frame
- Choose from either single or double-sided racks to meet your storage needs
- Durable Kleton blue enamel finish



Round hook



Square hook

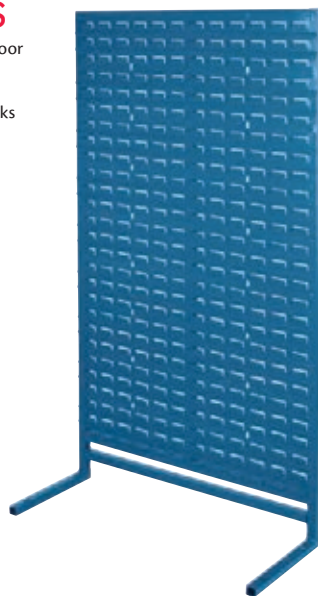

### RACK ONLY

Model No.	Description	Rack Type	Rack Dimensions W" x D" x H"	Wt. lbs.	Price /Each
CB373	Rack only	Single	36 x 12 x 61	60	425.00
CB653	Rack only	Double	36 x 24 x 61	100	625.00

### RACK/BIN COMBINATION

Model No.				Rack Type	Overall Bin Dimensions W" x D" x H"	Bin Qty	Capacity lbs.	Price /Each
Blue	Red	Yellow	Green					
CB654	CB655	CB656	CB685	Single	8 1/4 x 14 3/4 x 7	28	1680	771.00
CB370	CB371	CB372	CB687	Double	8 1/4 x 14 3/4 x 7	56	3360	1336.00

### ACCESSORIES FOR LOUVERED PANELS

Model No.	Description	Price/Each
CC165	Round Hook, 6"	51.50
CC166	Round Hook, 12"	53.50
CC167	Square Hook, 6"	48.90
CC168	Square Hook, 12"	51.50

### SINGLE SIDED

- Includes 3" casters and two louvered panels
- Capacity: 800 lbs.



CB359  
Single sided

### DOUBLE SIDED

- Includes bolted-on 5" non-marking casters and six louvered panels
- Capacity: 1000 lbs.



CB090  
Double sided

### MIX & MATCH

Need more bins that will fit the products on this page  
See pages 204-205



## BIN/PEGBOARD COMBO RACK

- Mobile rack designed with (1) side pegboard & (1) side louvered panels (2 continuous)
- All-welded construction
- Square tube frame with angle iron base
- Equipped with (4) 5" non-marking, blue rubber casters (2 swivel, 2 rigid)
- Durable Kleton Blue enamel finish
- Bins not included
- Unit Type: Double-sided



Model No.	Capacity lbs.	Rack Dimensions W" x D" x H"	Price /Each
RN555	1000	38 x 24-1/2 x 55	785.00



# BINS

## BENCH LOUVERED RACKS

- All-welded louvered bench rack
- Provides tool and storage for assembly or repair operations when combined with plastic parts bin
- Durable Kleton blue enamel finish

### 36" FREE STANDING RACKS

- Free standing unit made of 1" square tube frame
- May be placed on any flat surface near a worksite without the need for bolts or fasteners

### 72" BOLT-ON RACKS

- Constructed of 1 1/4" square tube frame
- Designed to be permanently installed on a 72" wide workbench



**KLETON**

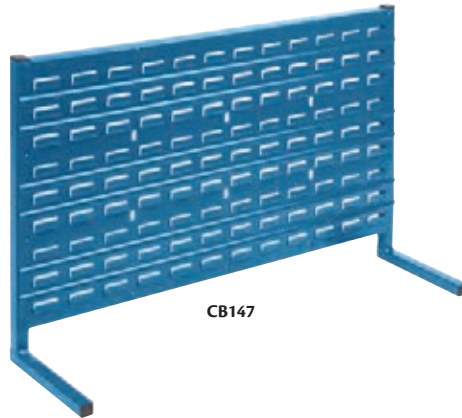

CB147

**MIX & MATCH**  
Need more bins that will fit the products on this page?  
See pages 204-205



### RACK ONLY

Model No.	Rack Type	Dimensions					Wt. lbs.	Price /Each
		W"	x	D"	x	H"		
CB363	Free Standing	36	x	10	x	22	22	225.00
CB364	Bolt-On	72	x	15	x	40	95	749.00

### RACK/BIN COMBINATION

Red	Blue	Model No.		Overall Bin Dimensions W" x D" x H"	Bin Qty	Bin Capacity lbs.	Price /Each
		Yellow	Green				
<b>36" LOUVERED</b>							
CB146	CB145	CB147	CF359	4 1/8 x 5 3/8 x 3	32	320	262.00
CB152	CB151	CB153	CF361	4 1/8 x 7 3/8 x 3	32	320	275.00
CB155	CB154	CB156	CF363	5 1/2 x 10 7/8 x 5	18	540	308.00
<b>72" LOUVERED</b>							
CB173	CB172	CB174	CF365	4 1/8 x 7 3/8 x 3	144	1440	1060.00
CB176	CB175	CB177	CF367	5 1/2 x 10 7/8 x 5	72	2160	1156.00
CB185	CB184	CB186	CF369	8 1/4 x 14 3/8 x 7	36	2160	1229.00



CB176  
Bench rack  
with bins

Work bench not included

## DEEP DOOR COMBINATION CABINETS

- All-welded heavy-duty 16-gauge, combination bin/shelf cabinet
- 4" deep hinged doors
- Unique padlock hasp helps prevent access with bolt cutters
- Powder coated Kleton grey finish
- Padlock sold separately

### 84 BIN CABINETS

- 4 reinforced 16-gauge main adjustable shelves with 500 lbs. capacity per shelf
- Incorporates louvered bin hanging panels welded into the cabinets doors

### CABINET ONLY

Model No.	Description	Dimensions					Wt. lbs.	Price /Each
		W"	x	D"	x	H"		
CB442	Cabinet only	38	x	24	x	72	324	2205.00
FB025	Extra shelf	38	x	18	x	1	18	135.00

### CABINET & BIN COMBINATION

Blue	Red	Model No.		Description	Wt. lbs.	Price /Each
		Yellow	Green			
CB446	CB477	CB448	CB693	Cabinet and plastic bins	341	2372.00

### BINS SUPPLIED

Bin Qty	Bin Size					Capacity lbs.
	W"	x	D"	x	H"	
84	4 1/8	x	5 3/8	x	3	10

**KLETON**



CB446



## DEEP DOOR COMBINATION CABINETS

- All-welded heavy-duty 16-gauge, combination bin/shelf cabinet
- 4" deep hinged doors
- Unique padlock hasp helps prevent access with bolt cutters
- Powder coated Kleton grey finish
- Padlock sold separately

### 96 BIN CABINETS

- Two reinforced 16-gauge main adjustable shelves with 500 lbs. capacity per shelf
- Incorporates louvered bin hanging panels welded to the cabinet's back and doors

#### CABINET ONLY

Model No.	Description	Dimensions					Wt. lbs.	Price /Each
		W"	x	D"	x	H"		
FH820	Cabinet only	38	x	24	x	72	316	2137.00
FB025	Extra shelf	38	x	18	x	1	18	135.00

#### CABINET & BIN COMBINATION

Blue	Red	Model No.		Description	Wt. lbs.	Price /Each
		Yellow	Green			
CF371	CF372	CF373	CF374	Cabinet and plastic bins	359	2365.00

#### BINS SUPPLIED

Bin Qty	Bin Size					Capacity lbs.
	W"	x	D"	x	H"	
84	4 1/8	x	5 3/8	x	3	10
12	5 1/2	x	10 7/8	x	5	30

### 98 BIN CABINETS

- 2 reinforced 16-gauge main adjustable shelves with 500-lbs. capacity per shelf
- Incorporates louvered bin hanging panels welded to the cabinet's back and doors

#### CABINET ONLY

Model No.	Description	Dimensions					Wt. lbs.	Price /Each
		W"	x	D"	x	H"		
FH820	Cabinet Only	38	x	24	x	72	316	2137.00
FB025	Extra shelf	38	x	18	x	1	18	135.00

#### CABINET & BIN COMBINATION

Blue	Red	Model No.		Description	Wt. lbs.	Price /Each
		Yellow	Green			
CF355	CF356	CF354	CF357	Cabinet and plastic bins	385	2546.00

#### BINS SUPPLIED

Bin Qty	Bin Size					Capacity lbs.
	W"	x	D"	x	H"	
48	5 3/8	x	4 1/8	x	3	10
36	7 3/8	x	4 1/8	x	3	10
8	14 3/4	x	8 1/4	x	7	60
6	14 3/4	x	16 1/2	x	7	75

### 118 BIN CABINETS

- Incorporates louvered bin hanging panels welded to the cabinet's back and doors

#### CABINET ONLY

Model No.	Description	Dimensions					Wt. lbs.	Price /Each
		W"	x	D"	x	H"		
CB441	Cabinet only	38	x	24	x	72	316	2135.00

#### CABINET & BIN COMBINATION

Blue	Red	Model No.		Description	Wt. lbs.	Price /Each
		Yellow	Green			
CB443	CB444	CB445	CB691	Cabinet and plastic bins	385	2679.00

#### BINS SUPPLIED

Bin Qty	Bin Size					Capacity lbs.
	W"	x	D"	x	H"	
42	5 3/8	x	4 1/8	x	3	10
42	7 3/8	x	4 1/8	x	3	10
18	10 7/8	x	5 1/2	x	5	30
12	14 3/4	x	8 1/4	x	7	60
4	14 3/4	x	16 1/2	x	7	75



CF373  
96 Bins



CF355  
98 Bins



CB444  
118 Bins

# BINS

## QUANTUM™ HULK CONTAINERS

- Heavy-duty injection-molded polypropylene stackable containers
- Organize and store your larger bulky items
- Extra large stacking containers offer a generous 2 to 2 1/2" in length to store your larger items
- Ideal for back-to-back use on 48" pallet rack or heavy-duty, extra deep shelving, and are available in a variety of widths and heights
- Heavy-duty front, back and side grips allow for easy handling
- Optional clear plastic window increases bin capacity and provides a quick view of the bin contents
- Optional dividers maximize flexibility and keep contents organized
- Wide stacking ledge and anti-slide lock keep stacked bins steady and prevent forward shifting
- Waterproof bins resist rust and corrosion
- Bins are autoclavable up to 250°F and are resistant to extreme cold
- **Do not hang on louvered panels or rail systems**

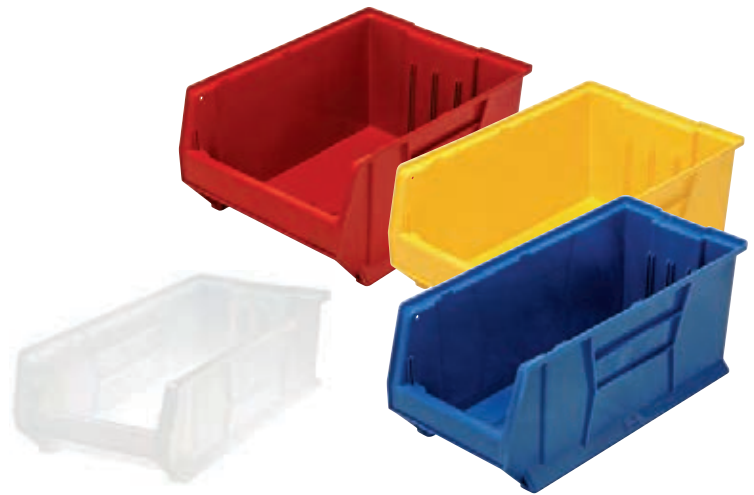

Model No.				Mfg. No.	Outside Dim.					Price /Each	Dividers	Price /Each	Windows	Price /Each
Blue	Red	Yellow	Clear		W"	x	D"	x	H"					
CD545	CD546	CD547	CF525	QUS950	8 1/4	x	23 7/8	x	7	35.50	CD563	14.90	CD569	4.89
CD548	CD549	CD550	CF526	QUS951	8 1/4	x	23 7/8	x	9	39.50	CD564	15.50	CD570	4.99
CD551	CD552	CD553	CF527	QUS952	11	x	23 7/8	x	7	42.50	CD563	14.90	CD571	5.09
CD554	CD555	CD556	CF528	QUS953	11	x	23 7/8	x	10	46.90	CD566	17.50	CD572	12.50
CD557	CD558	CD559	CF529	QUS954	16 1/2	x	23 7/8	x	11	73.50	CD567	15.90	CD573	12.90
CD560	CD561	CD562	CF530	QUS955	18 1/4	x	23 7/8	x	12	74.90	CD568	19.90	CD574	17.90
CF196	CF197	CF198	-	QUS970	8 1/4	x	29 7/8	x	7	42.90	-	-	CD569	4.89
CF199	CF200	CF201	-	QUS973	11	x	29 7/8	x	10	60.90	-	-	CD572	12.50
CF202	CF203	CF204	-	QUS974	16 1/2	x	29 7/8	x	11	81.90	-	-	CD573	12.90
CF205	CF206	CF207	-	QUS975	18 1/4	x	29 7/8	x	12	94.90	-	-	CD574	17.90
CF208	CF209	CF210	-	QUS976	16 1/2	x	29 7/8	x	15	105.00	-	-	CF211	20.50

## STORE MORE™ PLASTIC SHELF BINS

- Durable, high density polypropylene bins
- Economical way to store and display parts and components
- Feature a moulded-in label holder and a built-in rear hang-lock which allows bins to tilt out for complete access when on shelving
- A wide hopper front allows complete access to the contents of the bin
- Edges are reinforced for added strength
- Designed for 12", 18" and 24" deep shelf units, racks or standard shelving
- Bins are waterproof, impervious to most chemicals and unaffected by grease or oil



Store more with 6" high shelf bins



Model No.				Mfg. No.	Outside Dim.					Inside Dim.					Price /Each	Dividers up to 7/bin	Bin Cups/Bin	
Blue	Yellow	Red	Clear		W"	x	D"	x	H"	W"	x	D"	x	H"			CD036	CD041
CF212	CF213	CF214	QSB201	4 1/8	x	11 5/8	x	6	3	x	10 1/6	x	6	7.19	CF248	6	2	
CF215	CF216	CF217	QSB202	6 5/8	x	11 5/8	x	6	5 1/2	x	10 1/6	x	6	10.90	CF249	9	4	
CF218	CF219	CF220	QSB207	8 3/8	x	11 5/8	x	6	7 1/8	x	10 1/6	x	6	11.50	CF250	12	4	
CF221	CF222	CF223	QSB209	11 1/8	x	11 5/8	x	6	10	x	10 1/6	x	6	16.90	CF251	18	6	
CF224	CF225	CF226	QSB203	4 1/8	x	17 7/8	x	6	3	x	16 1/2	x	6	12.50	CF252	9	3	
CF227	CF228	CF229	QSB204	6 5/8	x	17 7/8	x	6	5 1/2	x	16 1/2	x	6	15.50	CF253	15	6	
CF230	CF231	CF232	QSB208	8 3/8	x	17 7/8	x	6	7 1/8	x	16 1/2	x	6	16.90	CF254	19	6	
CF233	CF234	CF235	QSB210	11 1/8	x	17 7/8	x	6	10	x	16 1/2	x	6	27.50	CF255	29	8	
CF236	CF237	CF238	QSB205	4 1/8	x	23 5/8	x	6	3	x	22 1/8	x	6	17.90	CF256	13	4	
CF239	CF240	CF241	QSB206	6 5/8	x	23 5/8	x	6	5 1/2	x	22 1/8	x	6	19.50	CF257	21	8	
CF242	CF243	CF244	QSB214	8 3/8	x	23 5/8	x	6	7 1/8	x	22 1/8	x	6	31.90	CF258	24	8	
CF245	CF246	CF247	QSB216	11 1/8	x	23 5/8	x	6	10	x	22 1/8	x	6	28.90	CF259	35	16	

### BIN DIVIDERS

Model No	Price /Each
CF248	1.32
CF249	1.39
CF250	3.20
CF251	3.69
CF252	1.32
CF253	1.39
CF254	3.20
CF255	3.69
CF256	1.32

### BIN DIVIDERS

Model No	Price /Each
CF257	1.39
CF258	3.20
CF259	3.69

### BIN CUPS

Model No	Dimensions				Price /Each	
	W"	x	D"	x	H"	
CD036	3	x	1 3/4	x	3	1.47
CD041	5 1/8	x	2 3/4	x	3	2.99



## QUANTUM™ BINS

- Heavy-duty, virgin, high density polypropylene/polyethylene
- Autoclavable up to 250° F
- Large multiple label slots
- Stackable
- Optional dividers and clear windows available for most units
- Hangs on louvered panels, rails and carts



CD669

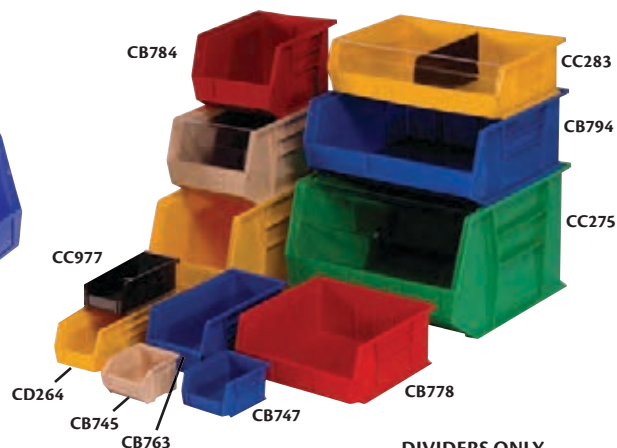

DIVIDERS ONLY



			Model No.				Mfg. No.	Outside Dim.			Qty /Case	Bin load Cap. lbs.	Price /Each	Depth Divider		Clear Window		
Black	Blue	Yellow	Red	Ivory	Green	W"		x	D"	x				H"	Model No.	Price /Each	Model No.	Price /Each
CC976	CB747	CB750	CB751	CB753	CC265	QUS 210	4 1/8	x	5 3/8	x	3	24	10	2.99	CB825	1.15	-	-
CC977	CB756	CB757	CB759	CB762	CC266	QUS 220	4 1/8	x	7 3/8	x	3	24	10	3.69	CB826	1.26	-	-
CF376	CF377	CF378	CF379	CF380	CF381	QUS 221	6	x	9 1/4	x	5	12	20	9.90	CF501	3.69	CF560	3.19
CD276	CD249	CD262	CD263	CD264	CD265	QUS 224	4 1/8	x	10 7/8	x	4	12	30	7.89	CD250	3.59	CD266	2.79
CC978	CB763	CB765	CB766	CB768	CC267	QUS 230	5 1/2	x	10 7/8	x	5	12	30	9.09	CB829	2.69	CB814	2.79
CC974	CC971	CC972	CC973	CC990	CC970	QUS 234	5 1/2	x	14 3/4	x	5	12	50	11.90	CC569	3.69	CB814	2.79
CC980	CB775	CB777	CB778	CB780	CC269	QUS 235	11	x	10 7/8	x	5	6	50	15.50	CB829	2.69	CB815	3.99
CC576	CB781	CB783	CB784	CB786	CC270	QUS 239	8 1/4	x	10 3/4	x	7	6	50	15.90	CB830	3.39	CB818	3.59
CC577	CB787	CB789	CB790	CB792	CC271	QUS 240	8 1/4	x	14 3/4	x	7	12	60	21.50	CB831	5.49	CB818	3.59
CF382	CF383	CF384	CF385	CF386	CF387	QUS 241	8 1/4	x	13 5/8	x	6	12	60	21.90	CF394	5.19	CF396	3.59
CF388	CF389	CF390	CF391	CF392	CF393	QUS 242	8 1/4	x	13 5/8	x	8	12	60	24.50	CF395	5.99	CF397	4.09
CC983	CC282	CC283	CC284	CC285	CC286	QUS 245	16 1/2	x	10 7/8	x	5	6	60	27.50	CC297	3.69	CC300	7.79
CC578	CB794	CB795	CB796	CB797	CC272	QUS 250	16 1/2	x	14 3/4	x	7	6	75	25.50	CB831	5.49	CB819	8.39
CC579	CB798	CB800	CB801	CB802	CC273	QUS 255	11	x	16	x	8	4	75	34.90	CB833	10.50	CB820	7.99
CC580	CB803	CB804	CB806	CB807	CC274	QUS 260	11	x	18	x	10	4	75	39.50	CB834	7.89	CB821	11.90
CC581	CC287	CC288	CC289	CC290	CC291	QUS 265	8 1/4	x	18	x	9	6	60	29.90	CC298	9.29	CC301	6.29
CC582	CB808	CB809	CB810	CB811	CC275	QUS 270	16 1/2	x	18	x	11	3	75	46.90	CB835	10.90	CB822	7.89
CD674	CD669	CD670	CD671	CD673	CD672	QUS 275MOB*	16 1/2	x	18	x	14	3	-	82.50	CB835	10.90	CB822	7.89

\* Mobile unit

## RECYCLED BINS

- Manufactured from recycled, 100% post consumer, high density polypropylene
- Can be stacked or hung in louvered pannels
- Available in black only



Model No.	Mfg. No.	Outside Dimensions				Price /Each	Dividers Model No.	Price /Each	
		W"	x	D"	x				H"
CC553	QUS210BR	4 1/8	x	5 3/8	x	3	1.79	CB825	1.15
CC554	QUS220BR	4 1/8	x	7 3/8	x	3	3.79	CB826	1.26
CE872	QUS224BR	4 1/8	x	10 7/8	x	4	4.79	CD250	3.59
CC555	QUS230BR	5 1/2	x	10 7/8	x	5	9.49	CB829	2.69
CC557	QUS234BR	5 1/2	x	14 3/4	x	5	11.50	CC569	3.69
CC558	QUS235BR	11	x	10 7/8	x	5	14.50	CB829	2.69
CC559	QUS239BR	8 1/4	x	10 3/4	x	7	16.50	CB830	3.39
CC560	QUS240BR	8 1/4	x	14 3/4	x	7	18.50	CB831	5.49
CC561	QUS245BR	16 1/2	x	10 7/8	x	5	18.50	CC297	3.69
CC562	QUS250BR	16 1/2	x	14 3/4	x	7	25.90	CB831	5.49
CC563	QUS255BR	11	x	16	x	8	23.50	CB833	10.50
CC564	QUS260BR	11	x	18	x	10	39.50	CB834	7.89
CC565	QUS265BR	8 1/4	x	18	x	9	25.90	CC298	9.29
CC566	QUS270BR	16 1/2	x	18	x	11	39.50	CB835	10.90

## RECYCLED SHELF BINS

- Manufactured from recycled 100% post consumer, high density polypropylene
- Available in black only



Model No.	Mfg. No.	Outside Dimensions				Price /Each	Dividers Model No.	Price /Each	
		W"	x	D"	x				H"
CB850	QSB 101BR	4 1/8	x	11 5/8	x	4	4.19	CB861	1.00
CB851	QSB 102BR	6 5/8	x	11 5/8	x	4	6.39	CB862	1.08
CB954	QSB 104BR	6 5/8	x	17 7/8	x	4	5.99	CB862	1.08
CB854	QSB 105BR	4 1/8	x	23 5/8	x	4	11.50	CB861	1.00
CB855	QSB 106BR	6 5/8	x	23 5/8	x	4	16.50	CB862	1.08
CB857	QSB 108BR	8 3/8	x	17 7/8	x	4	8.29	CB867	2.59
CB860	QSB 114BR	8 1/8	x	23 5/8	x	4	19.50	CB867	2.59
CC304	OSB 116BR	11 1/8	x	23 5/8	x	4	23.90	CB869	2.99
CC241	QGH 700BR	19 7/8	x	15 1/4	x	12 7/16	30.50	N/A	-



## GIANT STACKING CONTAINERS

- Injection moulded from high density polypropylene
- Extra heavy, double wall thickness with interlock preformed lip allows containers to stack securely
- Moulded carrying handle on backside
- Moulded-in divider and label slots
- Optional windows available
- Can withstand temperatures ranging from -40° to 250°F
- Waterproof, will not rust or corrode
- Unaffected by chemicals and solvents
- Mobile bin comes with 2 swivel and 2 swivel with brakes 3" casters
- 250-lb mobile capacity
- 150-lb stack capacity



CC447

### BINS

Model No.				Mfg. No.	Outside Dimensions					Price /Each	DIVIDERS		WINDOWS	
Blue	Green	Red	Yellow		W"	x	D"	x	H"		Model No.	Price /Each	Model No.	Price /Each
CC361	CC362	CC363	CC364	QMS531	12 3/8	x	19 3/4	x	5 7/8	29.50	CC381	10.50	CC385	8.09
CC365	CC366	CC367	CC368	QMS532	12 3/8	x	19 3/4	x	7 7/8	31.90	CC382	12.50	CC386	9.79
CC369	CC370	CC371	CC372	QMS533	12 3/8	x	19 3/4	x	11 7/8	31.90	CC383	14.50	CC387	10.90
CC373	CC374	CC375	CC376	QMS543	18 3/8	x	19 3/4	x	11 7/8	60.50	CC384	14.50	CC388	11.90
CC377*	CC378*	CC379*	CC380*	QMS743	18 3/8	x	29	x	11 7/8	94.90	-	-	-	-
CC447*	CC449*	CC448*	CC450*	QMS843MOB**	18 3/8	x	29	x	11 7/8	192.00	-	-	-	-

\* Includes heavy-duty spread bar for extra strength and support \*\* Mobile bins

## GIANT OPEN HOPPER BIN SHELVING UNITS

- Dimensions: 18" D x 42" W x 76" H
- Capacity: 480 lbs. per shelf
- Shipped knocked down



CF189



CF193



CF081

### SERIES QMS516

- 4-QMS543-red, 3-QMS533-blue, 6-QMS532-yellow and 3-QMS531-blue open hopper bins (see chart above for bin dimensions)
- 7 heavy-duty grey enamel shelves

Model No.				Description	Price /Each
Red	Blue	Yellow	Green		
<b>SERIES QMS531</b>					
CF188	CF185	CF186	CF187	Starter	1472.00
CF784	CF785	CF786	CF787	Add-on	1388.00
<b>SERIES QMS532</b>					
CF072	CF073	CF074	CF075	Starter	1247.00
CF089	CF090	CF091	CF092	Add-on	1164.00
<b>SERIES QMS533</b>					
CF080	CF081	CF082	CF083	Starter	961.00
CF097	CF098	CF099	CF100	Add-on	878.00
<b>SERIES QMS543</b>					
CF193	CF190	CF191	CF192	Starter	1082.00
CF789	CF790	CF791	CF792	Add-on	999.00
<b>SERIES QMS516</b>					
CF189	-	-	-	Starter	1146.00
CF788	-	-	-	Add-on	1062.00

\* Mixed colors

### SERIES QMS543

- 10-QMS543 open hopper bins 19 3/4" W x 18 3/8" D x 11 7/8" H
- 6 heavy-duty grey enamel shelves



CF074

### SERIES QMS533

- 15 QMS533 open hopper bins 19 3/4" W x 12 3/8" D x 11 7/8" H
- 6 heavy-duty grey enamel shelves



CF187

### SERIES QMS532

- 21 QMS532 open hopper bins 19 3/4" W x 12 3/8" D x 7 7/8" H
- 8 heavy-duty grey enamel shelves

### SERIES QMS531

- 27-QMS531 open hopper bins 19 3/4" W x 12 3/8" D x 5 7/8" H
- 10 heavy-duty grey enamel shelves

## JUMBO PLASTIC CONTAINERS

- Extra-large size provides massive amount of storage capacity
- Guaranteed unbreakable and distortion-free from -40°C to 120°C
- Unaffected by oil, alkaline, and most acids
- Nesting design allows for minimal storage space when not in use
- Stackable for added space savings, up to 4 high
- Outside dimensions: 15 1/2" W x 25" D x 13" H
- Inside dimensions: 13 1/2" W x 22 3/5" D x 12" H
- Capacity: 200 lbs.

KLETON



Model No.	Colour	Price /Each
CF329	Green	58.95
CF327	Red	58.95

Model No.	Colour	Price /Each
CF328	Blue	58.95
CF330	Yellow	58.95

## WIDE SPAN SHELVEING WITH JUMBO PLASTIC BINS

- Ideal for storing supplies in warehouses or shops
- No bolt shelving system can be built quickly and easily
- 12-gauge steel posts and 13-gauge beams
- Shelf levels include 5/8" particleboard decking and required tie bars
- Capacity is 800 lbs. per shelf evenly distributed
- Offered configurations include three levels with 12 bins and four levels with 16 bins
- Plastic bin dimensions: 15 1/2" W x 25" D x 13" H
- Assembly required



RL984



RL989

KLETON



Model No.	Shelving Size			No. of Shelves	No. of Bins	Colour	Price /Each
	W" x D" x H"						
RL984	66	x 18	x 60	3	12	Red	1311.00
RL985	66	x 18	x 60	3	12	Blue	1311.00
RL986	66	x 18	x 60	3	12	Green	1311.00
RL987	66	x 18	x 60	3	12	Yellow	1311.00
RL988	66	x 18	x 60	3	12	Red, Blue, Yellow	1311.00
RL980	66	x 18	x 72	4	16	Red	1589.00
RL981	66	x 18	x 72	4	16	Blue	1589.00
RL982	66	x 18	x 72	4	16	Green	1589.00
RL983	66	x 18	x 72	4	16	Yellow	1589.00
RL989	66	x 18	x 72	4	16	Red, Blue, Yellow, Green	1589.00

## WIRE SHELVEING UNITS WITH STORAGE BINS

Same great features as the Kleton chromate wire shelving, but with the added convenience of heavy-duty storage bins.

- Adjustable chromate wire shelves
- Wire shelving resists corrosion and provides greater visibility to stored parts
- Wire shelves prevent build up of dust and dirt
- Bins are unaffected by oil, alkaline, and most acids
- Ideal in production or for parts storage
- NSE certified
- Assembly required
- Unit's total capacity should not exceed 2000-lb.



RL826



RL825



KLETON

Model No.	Shelving Size			No. of Shelves	Bin Size			No. of Bins	Colour	Price /Each
	W" x D" x H"				W" x D" x H"					
RL823	36	x 24	x 74	5	15 1/2	x 25	x 13	8	Blue	800.00
RL824	36	x 24	x 74	5	15 1/2	x 25	x 13	8	Yellow	800.00
RL825	36	x 24	x 74	5	15 1/2	x 25	x 13	8	Green	800.00
RL826	36	x 24	x 74	5	15 1/2	x 25	x 13	8	Red	800.00



# BINS

## SHELF BINS

- Economical way to store and display parts and components
- Durable polypropylene
- Designed for use on 12", 18" and 24" deep shelving, or vertical storage and retrieval units
- Shelf bins "nest" when empty
- Bin cups and dividers available



The special built-in hanglock catches the underside of the shelf above, allowing each bin to be tilted out for complete access.

Bin Model No.					Mfg. No.	Outside Dimensions				Price /Each	Dividers, up to 7 per bin				Bin Cup Per Bin		
Blue	Red	Yellow	Clear	Green		W"	x	D"	x		H"	CD035	CD040	CD036	CD041		
CC992	CC994	CC993	-	CC995	QSB100	2 3/4	x	11 5/8	x	4	4.39	N/A	3	-	3	-	
CC998	CD001	CC999	-	CD002	QSB101	4 1/8	x	11 5/8	x	4	4.19	CB861	6	2	6	2	
CD005	CD007	CD006	-	CD008	QSB102	6 5/8	x	11 5/8	x	4	6.39	CB862	9	4	-	-	
CC393	CC394	CC395	CF531	CD023	QSB107	8 3/8	x	11 5/8	x	4	8.09	CB867	12	4	12	4	
CC396	CC397	CC398	CF532	CD026	QSB109	11 1/8	x	11 5/8	x	4	10.90	CB869	18	6	18	6	
CD011	CD013	CD012	-	CD014	QSB103	4 1/8	x	17 7/8	x	4	6.69	CB861	9	3	9	3	
CD017	CD019	CD018	-	CD020	QSB104	6 5/8	x	17 7/8	x	4	8.39	CB862	15	6	15	6	
CC399	CC400	CC401	CF533	CD029	QSB108	8 3/8	x	17 7/8	x	4	13.50	CB867	19	6	19	6	
CC402	CC403	CC404	CF534	CD032	QSB110	11 1/8	x	17 7/8	x	4	19.50	CB869	29	8	29	8	
CC405	CC406	CC407	CF535	CD045	QSB105	4 1/8	x	23 5/8	x	4	11.50	CB861	13	4	13	4	
CC408	CC409	CC423	CF536	CD048	QSB106	6 5/8	x	23 5/8	x	4	15.50	CB862	21	8	21	8	
CC411	CC412	CC413	CF537	CD051	QSB114	8 3/8	x	23 5/8	x	4	19.90	CB867	24	8	24	8	
CC414	CC415	CC416	CF538	CD054	QSB116	11 1/8	x	23 5/8	x	4	24.50	CB869	35	16	35	16	

### BIN DIVIDERS

Model No.	Mfg. No.	Description	Price /Each
CB867	DSB107	Divider, 8 1/8" wide	2.59
CB869	DSB109	Divider, 11 1/8" wide	2.99
CB861	DSB101	Divider, 4 1/8" wide	1.00
CB862	DSB102	Divider, 6 5/8" wide	1.08

### BIN CUPS

Model No.	Mfg. No.	Colour	Description	Qty	Price /Each
CD035	QBC111	Blue	Bin cup, 3 1/4" x 1 3/4"	48	1.46
CD040	QBC112	Blue	Bin cup, 5 1/8" x 2 3/4"	48	3.29
CD036	QBC111	Yellow	Bin cup, 3 1/4" x 1 3/4"	48	1.47
CD041	QBC112	Yellow	Bin cup, 5 1/8" x 2 3/4"	48	2.99

### EXTENDED LABEL HOLDERS

Model No.	Mfg. No.	Colour	Angle	Qty/Box	Price/Box
CF398	ELH410	Black	10°	24	63.50
CF399	ELH415	Black	45°	24	63.50

## RECYCLED SHELF BINS

- Manufactured from recycled 100% post consumer, high density polypropylene
- Available in black only

Model No.	Mfg. No.	Outside Dimensions				Price /Each	Dividers up to 7/bin Model No.	Price /Each
		W"	x	D"	x			
CC303	QSB 100 BR	2 3/4	x	11 5/8	x	4	-	-
CB850	QSB 101 BR	4 1/8	x	11 5/8	x	4	CB861	1.00
CB851	QSB 102 BR	6 5/8	x	11 5/8	x	4	CB862	1.08
CB852	QSB 103 BR	4 1/8	x	17 7/8	x	4	CB861	1.00
CB954	QSB 104 BR	6 5/8	x	17 7/8	x	4	CB862	1.08
CB854	QSB 105 BR	4 1/8	x	23 5/8	x	4	CB861	1.00
CB855	QSB 106 BR	6 5/8	x	23 5/8	x	4	CB862	1.08
CB857	QSB 108 BR	8 3/8	x	17 7/8	x	4	CB867	2.59
CB860	QSB 114 BR	8 1/8	x	23 5/8	x	4	CB867	2.59
CC304	QSB 116BR	11 1/8	x	23 5/8	x	4	CB869	2.99

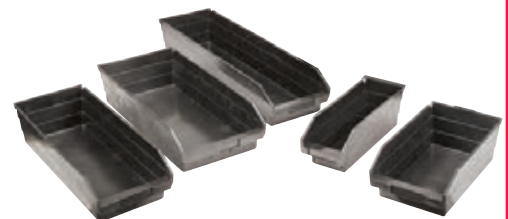

## STORE-MAX SHELF BINS

- Helps maximize and organize your space
- Features a molded-in label holder and built-in rear hanglock which allows bin to tilt out for easy access
- Wide hopper front allows for complete access
- Reinforced edges for additional strength
- Designed for use on 12", 18" and 24" deep shelving
- Bins nest when empty



Model No.				Mfg. No.	Outside Dim.				Price /Each	Dividers up to 7/bin	Bin Cups/Bin				
Blue	Red	Yellow	Clear		W"	x	D"	x			CD036	CD041	CD035	CD040	
CF864	CF865	CF866	CF867	QSB801	4 3/8	x	11 5/8	x	8	12.90	CF912	6	2	6	2
CF868	CF869	CF870	CF871	QSB802	6 5/8	x	11 5/8	x	8	12.90	CF913	9	4	9	4
CF872	CF873	CF874	CF875	QSB807	8 3/8	x	11 5/8	x	8	16.50	CF914	12	4	12	4
CF876	CF877	CF878	CF879	QSB809	11 1/8	x	11 5/8	x	8	20.50	CF915	18	6	18	6
CF880	CF881	CF882	CF883	QSB803	4 3/8	x	17 7/8	x	8	16.50	CF916	9	3	9	3
CF884	CF885	CF886	CF887	QSB804	6 5/8	x	17 7/8	x	8	18.50	CF917	15	6	15	6
CF888	CF889	CF890	CF891	QSB808	8 3/8	x	17 7/8	x	8	19.50	CF918	19	6	19	6
CF892	CF893	CF894	CF895	QSB810	11 1/8	x	17 7/8	x	8	34.50	CF919	29	8	29	8
CF896	CF897	CF898	CF899	QSB805	4 3/8	x	23 5/8	x	8	21.90	CF920	13	4	13	4
CF900	CF901	CF902	CF903	QSB806	6 5/8	x	23 5/8	x	8	23.50	CF921	21	8	21	8
CF904	CF905	CF906	CF907	QSB814	8 3/8	x	23 5/8	x	8	30.90	CF922	24	8	24	8
CF908	CF909	CF910	CF911	QSB816	11 1/8	x	23 5/8	x	8	35.90	CF923	35	16	35	16

## STORE-MAX DIVIDERS

- Colour: Black
- Fits horizontally across bins to create compartments



Model No.	Mfg No.	Description	Price /Each
CF912	DSB801	Divider, 3" wide	2.09
CF913	DSB802	Divider, 5 1/2" wide	2.29
CF914	DSB807	Divider, 7 1/8" wide	2.39
CF915	DSB809	Divider, 10" wide	5.19
CF916	DSB803	Divider, 3" wide	2.09
CF917	DSB804	Divider, 5 1/2" wide	2.29
CF918	DSB808	Divider, 7 1/8" wide	2.39
CF919	DSB810	Divider, 10" wide	5.19
CF920	DSB805	Divider, 3" wide	2.09
CF921	DSB806	Divider, 5 1/2" wide	2.29
CF922	DSB814	Divider, 7 1/8" wide	2.39
CF923	DSB816	Divider, 10" wide	5.19

## DIVIDER LABEL TAB

- Improve visibility of bin labels and scanning of barcodes
- Colour: Black



Model No.	Mfg No.	Description	Qty/Box	Price /Box
CF925	DLT-6	Black Divider Label Tab	6	6.59

## BIN CUPS



Model No.	Mfg No.	Colour	Description	Price /Each
CD035	QBC111	Blue	Bin Cup, 3 1/4" x 1 3/4" x 3"	1.46
CD036	QBC111	Yellow	Bin Cup, 3 1/4" x 1 3/4" x 3"	1.47
CD040	QBC112	Blue	Bin Cup, 5 1/8" x 2 3/4" x 3"	3.29
CD041	QBC112	Yellow	Bin Cup, 5 1/8" x 2 3/4" x 3"	2.99

## SHELF BINS - EXTENDED LABEL HOLDERS

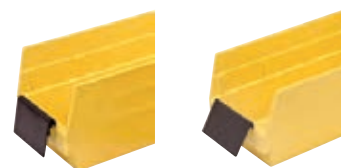

Model No.	Mfg No.	Colour	Angle	Qty/Box	Price /Box
CF398	ELH410	Black	10°	24	63.50
CF399	ELH415	Black	45°	24	63.50

## CLEAR LABEL HOLDER & INSERT

- Laser & inkjet compatible inserts
- 8 1/2" x 11" perforated sheets included
- Colour: Clear
- Fits all 8" height Quantum™ shelf bins



Model No.	Mfg No.	Description	Qty/Box	Price /Box
CF924	LTR-1253	Label Holder & Insert	25	50.50



## EURO DRAWERS

- Heavy-duty design for efficient organization of heavy parts, supplies, tools or equipment
- Injection moulded from virgin grade high-impact polystyrene
- 12-gauge thick wall
- Completely waterproof
- Oil and chemical-resistant
- Smooth front curved pull handle has ample room for pressure sensitive identification labels or bar codes
- Front handle has 3/4" opening
- Full width back ledge ensures spill free use

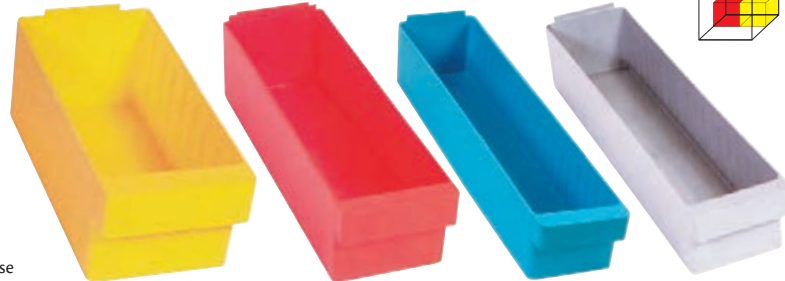

Add dividers to Euro Drawers for additional storage possibilities!

CC502

CC508

CC509

CC515

Model No.				Mfg. No.	Outside Dimensions			Price /Each	Divider Model No.	Price /Each
Blue	Grey	Red	Yellow		W"	x D"	x H"			
CE289	CE291	CE292	CE290	QED401	5 9/16	x 11 5/8	x 2 5/8	10.50	CE309	2.49
CE293	CE295	CE296	CE294	QED501	3 3/4	x 11 5/8	x 4 5/8	12.90	CC518	1.41
CC501	CC503	CC504	CC502	QED601	5 9/16	x 11 5/8	x 4 5/8	13.90	CC517	2.46
CC505	CC507	CC508	CC506	QED602	5 9/16	x 17 5/8	x 4 5/8	16.90	CC517	2.46
CC509	CC511	CC512	CC510	QED603	5 9/16	x 23 7/8	x 4 5/8	22.50	CC517	2.46
CC513	CC515	CC516	CC514	QED604	3 3/4	x 17 5/8	x 4 5/8	15.50	CC518	1.41
CE305	CE307	CE308	CE306	QED606	8 3/8	x 17 5/8	x 4 5/8	22.50	CE312	4.09
CE297	CE299	CE300	CE298	QED701	8 3/8	x 11 5/8	x 4 5/8	16.90	CE312	4.09
CE301	CE303	CE304	CE302	QED801	11 1/8	x 11 5/8	x 4 5/8	18.90	CE314	3.69

## EURO DRAWER CLOSED SHELF UNITS

- 13 heavy-duty grey enamel shelves
- Capacity: 630 lbs. per shelf
- Shipped knocked down



### INCLUDES:

- 72 QED601 Series Euro drawers, 11 5/8" W x 5 9/16" D x 4 5/8" H
- Dimensions: 36" W x 12" D x 76" H

Model No.				Description	No. of Shelves	Price /Each
Blue	Yellow	Grey	Red			
CF102	CF103	CF104	CF105	Starter	13	1765.00
CF159	CF160	CF161	CF162	Add-On	13	1663.00

- 72 QED602 Series Euro drawers 17 5/8" W x 5 9/16" D x 4 5/8" H
- Dimensions: 36" W x 18" D x 76" H

CF106	CF107	CF108	CF109	Starter	13	2170.00
CF163	CF164	CF165	CF166	Add-On	13	2050.00

- 108 QED604 Series Euro drawers 17 5/8" W x 3 3/4" D x 4 5/8" H
- Dimensions: 36" W x 18" D x 76" H

CF110	CF111	CF112	CF113	Starter	13	2625.00
CF167	CF168	CF169	CF170	Add-On	13	2504.00

- 72 QED603 Series Euro drawers 23 7/8" W x 5 9/16" D x 4 5/8" H
- Dimensions: 36" W x 24" D x 76" H

CF114	CF115	CF116	CF117	Starter	13	2769.00
CF171	CF172	CF173	CF174	Add-On	13	2630.00

## RACKBIN™ 42" PALLET RACK CONTAINERS

- Extra-large bins offer a generous 42" in length to store your larger items
- 42" length ensures no wasted space on 42" deep rack
- Heavy-duty front, back and side grips allow for easy handling
- Wide stacking ledge and anti-slide lock keeps stack bins steady and prevent forward shifting
- Have eight 1/4" drill hole pattern on bottom of bin for easy hole insertion for drainage and air circulation if needed
- Waterproof bins are corrosion free
- Available in blue and gray



Model No.		Mfg No.	Outside Dimension			Inside Dimensions			Wt. lbs.	Price /Each
Blue	Gray		W"	x D"	x H"	W"	x D"	x H"		
CF539	CF540	QRB166	16 1/2	x 41 7/8	x 17 1/2	14	x 40 1/8	x 16 1/2	16	165.00
CF541	CF542	QRB206	19 7/8	x 41 7/8	x 17 1/2	17 3/8	x 40 1/8	x 16 1/2	17	189.00
CF543	CF544	QRB246	23 7/8	x 41 7/8	x 17 1/2	21 1/2	x 40 1/8	x 16 1/2	19	199.00



## DEEP CORRUGATED PARTS BINS

- Economical standard duty bins constructed of durable corrugated fibreboard
- Ideal for storing any loose small parts
- Assembled easily without staples or tape, just fold
- Bins are designed to hang from the shelf for hands-free access
- Bin dividers not included
- Shipped knocked down
- Colour: Beige



## M Mitchel Lincoln

Model No.	Mfg. No.	Capacity lbs.	Outside Dimensions					Price /Each
			W"	x	D"	x	H"	
CG168	MLCG168	17	2	x	12	x	4-1/2	1.59
CG169	MLCG169	19	3	x	12	x	4-1/2	1.46
CG170	MLCG170	20	4	x	12	x	4-1/2	1.37
CG171	MLCG171	31	6	x	12	x	4-1/2	1.44
CG172	MLCG172	31	8	x	12	x	4-1/2	2.36
CG173	MLCG173	38	10	x	12	x	4-1/2	2.99
CG174	MLCG174	44	12	x	12	x	4-1/2	2.19
CG175	MLCG175	36	9	x	12	x	4-1/2	3.59
CG176	MLCG176	22	2	x	18	x	4-1/2	1.69
CG177	MLCG177	27	3	x	18	x	4-1/2	3.29
CG178	MLCG178	30	4	x	18	x	4-1/2	1.69
CG179	MLCG179	38	6	x	18	x	4-1/2	2.72
CG180	MLCG180	45	8	x	18	x	4-1/2	2.39
CG181	MLCG181	50	10	x	18	x	4-1/2	4.29
CG182	MLCG182	57	12	x	18	x	4-1/2	2.89

## CORRUGATED DEEP REMOVABLE DIVIDERS

- Economical standard duty bins constructed of durable corrugated fibreboard
- Ideal for storing any loose small parts
- Assembled easily without staples or tape, just fold
- Shipped knocked down



## M Mitchel Lincoln

Model No.	Mfg. No.	Capacity lbs.	Dimensions			Price /Each
			W"	x	H"	
CG183	ML-CG183	7	1-3/4	x	4-1/8	1.11
CG189	MLCG189	9	2-3/4	x	4-1/8	1.19
CG184	MLCG184	10	3-3/4	x	4-1/8	1.14
CG185	MLCG185	14	5-3/4	x	4-1/8	1.19
CG186	MLCG186	22	7-3/4	x	4-1/8	1.59
CG187	MLCG187	27	9-3/4	x	4-1/8	1.79
CG188	MLCG188	31	11-3/4	x	4-1/8	1.45

## GENERAL PURPOSE PAILS

- Snap on lids available: **Dry seal type** or **gasket type** for liquid handling
- Galvanized steel handles except Model **CB040**
- Lids sold separately

## ROPAK



Model No.	Description	Dimensions Dia" x W"	Lid Type	Wt. lbs.	Price /Each
<b>CONTAINERS</b>					
CB040	4-L pail w/plastic handle	8 1/4 x 6	-	0.5	9.39
CB043	11.4-L pail w/metal handle	11 x 9	-	1.1	17.50
CB046	20-L pail w/metal handle	11 7/8 x 15 3/8	-	2.0	27.90
<b>LIDS</b>					
CB039	Lid for pails 4, 5, 6 L w/static joint	8 1/2 x 1/2	Gasket	0.2	4.39
CB041	Lid for pails 11.4 L w/o static joint	11 3/8 x 5/8	Dry Seal	0.3	7.09
CC426	Lid for 20-L pail	12 1/2 x 5/8	Dry Seal	0.4	9.59
CB045	Heavy-duty lid for 20 and 23-L pails w/pouring spout	12 1/8 x 3/4	Gasket	0.6	12.50

# CONTAINERS



- Polywuton Stack-N-Nest containers used in general manufacturing, food processing and distribution applications
- Injection moulded from high density polyethylene
- Will not rust, rot or corrode, resist damaging effects of oil, most chemical solvents, water and steam
- Stack without covers
- Nest at alternating 180° positions when empty
- Withstands wide temperature variances
- Easily cleaned

Manufactured from FDA compliant materials

## COVERS

	Model No.			Price /Each
	Grey	Red	Blue	
A.	CA334	CC877	CC883	18.09
B.	CA337	CC880	CC886	19.09
C.	CA335	CC878	CC884	16.99
D.	CA336	CC879	CC885	23.99
E.	CA339	CC882	CC888	32.59
F.	CA338	CC881	CC887	34.69

## CONTAINERS

Grey	Model No.			Mfg No.	Outside Dimensions Top			Outside Dimensions Bottom			Overall Height"	Volume cu.ft.	Nesting Ratio	Wt. lbs.	Uses Cover*	Price /Each
	Red	Blue			L"	x	W"	L"	x	W"						
CA341	CC859	CC868		SN2012-6	20.1	x	13.0	18.5	x	11.5	6.2	0.6	2.1:1	2.1	A	33.79
CA344	CC860	CC869		SN2414-8	24.0	x	14.1	21.8	x	11.5	7.9	1.1	4:1	3.4	B	46.99
CA342	CC861	CC870		SN2013-12	19.4	x	12.9	17.3	x	10.9	12.1	1.3	4:1	3.8	C	52.99
CA343	CC862	CC871		SN2117-12	21.0	x	17.0	18.8	x	15.0	12.0	1.8	4:1	5.0	D	74.79
CA346	CC863	CC872		SN2618-10	26.1	x	18.7	24.0	x	15.9	10.5	2.1	4:1	5.4	E	76.59
CA348	CC864	CC873		SN3022-6	29.6	x	22.4	28.3	x	21.0	6.1	2.1	4:1	4.8	N/A	74.39
CA347	CC865	CC874		SN2818-10	28.4	x	18.7	26.0	x	15.9	10.5	2.3	4:1	5.8	N/A	79.09
CA345	CC866	CC875		SN2420-13	24.0	x	20.0	21.6	x	17.7	13.0	2.7	4:1	6.1	F	76.49
CA349	CC867	CC876		SN3024-15	30.1	x	24.0	27.0	x	21.0	15.1	4.7	4.5:1	11.0	N/A	155.00

## STACK-N-NEST® STORAGE BINS

- Great for storing, assembling and transporting small parts, components and finished goods
- Designed for maximum efficiency and utility
- Set together one way they stack and the other way they nest
- May be used on shelving or stacked up
- Heavy-duty design allows higher stacking
- In the plant, use the same bin for storage, handling, and assembly, no need to transfer contents



Model No.	Colour	Outside Dimensions				Wt. lbs.	Price /Each
		L"	x	W"	x	D"	
CC890	Blue	15 1/4	x	12 1/4	x	6	23.10

## STACK & NEST TOTES

- Will stack with or without lids for maximum storage and shipping
- Ability to stack and can be turned 180° to nest when empty
- Textured bottoms ensure safe and easy, non-slip grip transit on conveyors
- Will not rust, corrode or bend out of shape
- Are unaffected by chemicals and are waterproof
- Fit on standard 48" x 40" pallets
- Can withstand temperature ranges from -10°F to 250°F
- Ribs under lip prevent jamming when nested
- Handle grips on either side
- Injection molded high density polypropylene
- FDA compliant materials



All nine sizes of totes have the ability to use the optional clear label holder. It securely attaches to SNT with or without lid for easy part identification.



Optional lids protect container contents. As pictured, lids can be fastened and locked for added security.

## COVERS

	Model No.				Qty /Case	Price /Each
	Blue	Grey	Red	Clear		
A.	CC342	CC343	CC344	CG094	6	13.90
B.	CC345	CC346	CC347	CG095	6	18.90
C.	CC348	CC349	CC350	CG096	6	25.90
D.	CC351	CC352	CC353	CG097	3	29.50
E.	CC354	CC355	CC356	CG098	3	28.50
F.	CC357	CC358	CC359	CG099	3	38.90



## CONTAINERS

Model No.		Mfg. No.	Outside Dimensions			Inside Dimensions			Use Cover	Qty /Case	Price /Each
Blue	Grey		Red	Clear	L" x W" x H"	L" x W" x H"	L" x W" x H"				
CC315	CC316	CC317	CG085	SNT180	18 x 11 x 6	15 1/4 x 9 3/8 x 5 7/8	A	6	24.50		
CC318	CC319	CC320	CG086	SNT185	18 x 11 x 9	15 1/8 x 9 1/8 x 8 7/8	A	6	28.90		
CC321	CC322	CC323	CG087	SNT190	19 1/2 x 15 1/2 x 10	16 x 13 1/4 x 9 7/8	B	6	34.90		
CC324	CC325	CC326	CG088	SNT195	19 1/2 x 15 1/2 x 13	15 7/8 x 13 3/8 x 12 7/8	B	6	38.90		
CC327	CC328	CC329	CG089	SNT200	19 1/2 x 13 1/2 x 8	16 3/8 x 11 1/2 x 7 7/8	C	6	28.90		
CC330	CC331	CC332	CG090	SNT225	23 1/2 x 19 1/2 x 10	19 3/8 x 16 7/8 x 9 7/8	D	3	57.90		
CC333	CC334	CC335	CG091	SNT230	23 1/2 x 19 1/2 x 13	19 1/2 x 16 7/8 x 12 7/8	D	3	61.90		
CC336	CC337	CC338	CG092	SNT240	23 1/2 x 15 1/2 x 12	19 5/8 x 13 x 11 7/8	E	3	52.90		
CC339	CC340	CC341	CG093	SNT300	29 1/2 x 19 1/2 x 15	25 1/8 x 16 5/8 x 14 7/8	F	3	83.90		



### Model No. CC360

Label holder, accommodates up to 3" x 5". Fits all SNT containers.

## QUANTUB NESTING TOTES

- High-density polyethylene
- Rolled top rim for comfortable grip
- Eight 1/4" position drill holes on bottom allow for drainage
- Dimensions: 24 1/2" L x 19" W x 9 1/2" H
- Made of FDA compliant materials

Model No. CD244 Grey

Model No. CD434 Blue

Price/Each \$43.90



## COLLAPSIBLE CONTAINERS

- Polypropylene construction
- Collapses to 21" L x 14" W x 2" H for convenient storage
- Open dimensions 21" L x 14" W x 10 1/2" H
- Reinforced base for added durability
- 16 heavy-duty steel pins built in for increased strength
- Capacity: 160 lbs.

Model No. CF326

Price/Each \$51.75

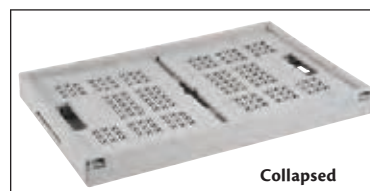
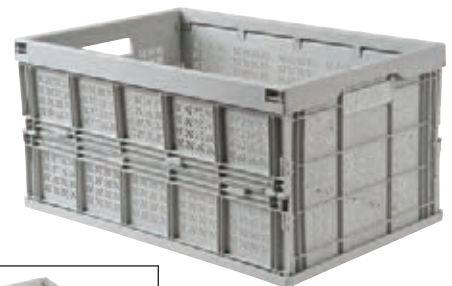

Collapsed





# CONTAINERS

## STAKPAK® PLUS 4845 SYSTEM CONTAINERS

- Stack-only, injection moulded, straight-wall modular containers
- High-density polyethylene (HDPE)
- Reinforced external ribbing adds maximum stacking strength
- Smooth, straight interior walls provide maximum space utilization and easy cleaning

- Modular design optimizes cube on standard 45" x 48" pallet, allows for mixing and matching of various sizes
- Ergonomically designed handles for comfort and safety
- Containers hold up under temperatures from -10°F to 120°F
- Optional covers and cardholders available



# ORBIS



48" x 15" (1/3)  
24" x 15" (1/6)  
12" x 15" (1/12)  
12" x 7" (1/24)

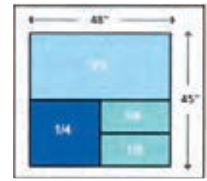

48" x 22" (1/2)  
24" x 22" (1/4)  
24" x 11" (1/8)

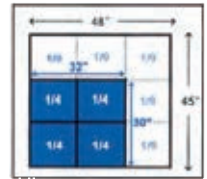

16" x 15" (1/4)  
on AIAG 30" x 32"  
15" x 15" (1/9)  
on AIAG 45" x 48"

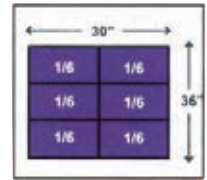

12" x 15" (1/6)

### STAKPAK® CONTAINERS

Model No.		Pallet Modularity (AIAG)		Outside Dimensions		Total Container Height"	Product Clearance"	Volume cu.ft.	48' Trailer Capacity (containers)	Wt. lbs.	Use with Cover	Use with Cardholder	Price /Each
Medium Green	Royal Blue	30" x 36"	45" x 48"	Top L" x W"	Bottom L" x W"								
CA498	CA499	CC112	1/12 1/24	12.0 x 7.4	12.0 x 7.4	5.0	4.5	0.1	8640	1.1	A	D	33.19
CA500	CA501	CC113	1/6 1/12	12.0 x 15.0	12.0 x 15.0	5.0	4.4	0.3	4320	1.7	B	D	32.79
CA502	CA503	CC114	1/6 1/12	12.0 x 15.0	12.0 x 15.0	7.5	6.8	0.5	3456	2.4		E	43.49
CA504	-	-	1/6 1/12	12.0 x 15.0	12.0 x 15.0	9.5	8.8	0.6	2304	2.5		E	48.89
CA507	CA508	CC116	- 1/6	24.0 x 15.0	24.0 x 15.0	5.0	4.4	0.7	2592	3.0	C	D	52.09
CA509	CA510	CC117	- 1/6	24.0 x 15.0	24.0 x 15.0	7.5	6.8	1.1	1728	3.5		E	66.49
CA511	CA512	CC118	- 1/6	24.0 x 15.0	24.0 x 15.0	9.5	8.8	1.4	1296	4.4		E	64.99
CA505	CA506	CC119	- 1/6	24.0 x 15.0	24.0 x 15.0	14.5	13.8	2.2	864	5.4		E	84.69

\* When containers are stacked on top of each other approximately 1/2" is lost to nesting.

### STAKPAK® COVERS

	Model No.		Dimensions			Wt. lbs.	Price /Each	
	Med. Green	Grey	Med. Green	Grey	Royal Blue			
A.	N/A	CA488	N/A	12.0	x	7.4	0.4	16.99
B.	CA489	CA490	CC121	12.0	x	15.0	0.8	19.79
C.	N/A	CA492	CC122	24.0	x	15.0	2.1	29.39

### CARDHOLDERS

	Model No.	Dimensions L" x W"	Price /Each
D.	CA448	8.5 x 4.0	2.76
E.	CA449	8.5 x 4.6	2.76

## FLIPAK®

- Reusable, returnable, attached-lid containers are ideal for use in wholesale product distribution and as picking containers
- Hinged covers with tight interlocking fit provide maximum security and protection

- Stack with lids closed and nest with lids open for optimum use of space in trucks, trailers or on pallets
- Load capacity per container is a maximum of 70-75 lbs.
- Bottom container will support 250 to 300 lbs. when stacked (Please inquire for exact load capacities)

## FLIPAK® POLYETHYLENE PLASTIC (PE) DISTRIBUTION CONTAINERS

- High density polyethylene (HDPE) construction offers maximum product protection from moisture, impact and chemicals



## FLIPAK® CLEAR POLYPROPYLENE PLASTIC (PP) DISTRIBUTION CONTAINERS

- Offer all the same benefits as the polyethylene containers, plus provide easy content identification
- Polypropylene (PP) is the same family as polyethylene
- Polypropylene's advantages over polyethylene include its greater stiffness and elevated use
- Temperature range: 30°F - 150°F



## ORBIS

Model No.	Outside Dimensions		Overall Height"	Volume Cu. Ft.	Nesting Ratio	Wt. lbs.	Price /Each
	Top L" x W"	Bottom L" x W"					
<b>LESS THAN 2.0 CU.FT.</b>							
CA452	-	CF265	11.8 x 9.8	9.3 x 7.0	7.7	0.3	2.8:1 2.1 36.00
CA453	-	CF266	15.2 x 10.9	12.8 x 7.8	9.7	0.6	4.0:1 3.0 41.00
CA454	-	-	21.8 x 15.1	18.9 x 13.7	5.5	0.7	3.6:1 5.7 66.90
CA455	-	CF268	19.7 x 11.8	16.9 x 9.3	7.3	0.7	3.0:1 3.4 36.00
CA456	-	-	20.6 x 13.5	18.2 x 11.7	6.5	0.8	2.1:1 6.2 69.90
CA457	-	-	20.6 x 13.2	17.7 x 11.0	11.6	1.4	4.4:1 5.9 66.00
CF559	CF556	CF557	21.9 x 15.2	19.1 x 13.3	9.3	1.3	4.4:1 5.0 41.00
CA461	-	CF273	22.3 x 13.0	19.1 x 10.9	12.8	1.6	3.8:1 6 50.90
CA462	CA463	CF274	21.8 x 15.2	18.6 x 12.9	12.9	1.8	4.0:1 6.5 47.89
CA464	-	-	23.5 x 15.7	19.9 x 13.0	13.0	1.9	4.5:1 6.9 71.90
<b>2.0 CU.FT. &amp; GREATER</b>							
CG165*	CG164*	CG167*	26.9 x 16.9	24.4 x 14.7	12.1	2.3	4.2:1 7.8 47.90
CA468	CA469	CF277	23.9 x 19.6	21.1 x 17.1	12.6	2.7	5.3:1 7.8 69.90
CA471	-	-	39.0 x 14.0	36.3 x 11.3	13.0	3.3	4.9:1 10.8 119.00
CF724*	CF726*	CF725*	27.9 x 20.9	25.8 x 18.8	15.2	4.0	2.7:1 12.0 88.00
CA475	-	-	30.0 x 22.0	27.4 x 19.4	20.5	6.1	4.0:1 16.5 159.00

\*Dollies available for these sizes

## ORBIS

Model No.	Outside Dimensions		Overall Height"	Volume Cu. Ft.	Nesting Ratio	Wt. lbs.	Price /Each
	Top L" x W"	Bottom L" x W"					
<b>LESS THAN 2.0 CU.FT.</b>							
CC128	11.8 x 9.8	9.3 x 7.0	7.7	0.3	2.8:1	2.1	41.50
CC129	15.2 x 10.9	12.8 x 7.8	9.7	0.6	4.0:1	3.0	49.90
CC130	19.7 x 11.8	16.9 x 9.3	7.3	0.7	3.0:1	3.4	46.90
CF558	21.9 x 15.2	19.1 x 13.3	9.3	1.3	4.4:1	5.0	55.90
CC132	21.8 x 15.2	18.6 x 12.9	12.9	1.8	4.0:1	6	67.90
<b>2.0 CU.FT. &amp; GREATER</b>							
CG166*	26.9 x 16.9	24.4 x 14.7	12.1	2.3	5.3:1	7.8	47.90

\*Dollies available for these sizes

## FLIPAK® DOLLY

- Allows for easy and efficient transport of multiple for Flipak® containers
- High corner supports hold totes in place
- Dollies securely stack together
- All-plastic construction is durable, increases service life and reduces product damage
- Rugged rubber casters withstand varying ground surfaces
- Standard 3" casters included

Model No.	Description	Inside Dim."	External Dim."	Height w/o Casters"	Price/Each
CF935	Compatible w/CF724 to CF726	24.6 L x 14.9 W	26 L x 18.9 W	6.25	315.00
CF936	Compatible w/CF503 to CF506	24.4 L x 14.6 W	26.9 L x 16.9 W	7	276.00

## ORBIS



## FLIP TOP PLASTIC DISTRIBUTION CONTAINERS

- Reusable containers are ideal for use in wholesale product distribution and as picking containers
- Hinged lids with tight interlocking fit provide added security and protection
- When lids are closed, containers can be easily stacked
- Nests with lids open for optimal use of space
- Volume Cu. Ft.: 1.8
- Height: 12.5"
- Width: 21.65"
- Depth: 15.5"



CG125



CG127



CG126

Model No.	Colour	Price /Each
CG125	Grey	37.95
CG126	Red	37.95
CG127	Blue	37.95

# CONTAINERS

## DIVIDER BOX® CONTAINERS

- Injection-molded HDPE
- Large, flat areas on all four sides for content identification
- Comfort grip handle
- Stacking rims and multi-ribbed external sides provide high impact strength
- All containers can be divided into compartments by length and/or width
- Molded-in stacking ridge assures containers will stack securely with or without covers
- Two cardholder snaps included
- Full range of optional accessories available including snap on card holders, short and long dividers and covers
- Load capacity 40 lbs. per container
- Can be divided into compartments of 1.25" centers with easy to add dividers
- Manufactured in high density polyethylene



Grey	Model No.			Mfg. No.	Dimensions					Volume Cu. Ft.	Uses Dividers & Accessories	Price /Each					
	Red	Light Blue			L"	x	W"	x	H"				L"	x	W"	x	H"
CA562	CC833	CC846		DC1025	10.8	x	8.3	x	2.5	9.2	x	6.6	x	2.5	0.07	A	16.69
CA565	CC836	CC849		DC2025	16.5	x	10.9	x	2.5	14.8	x	9.2	x	2.5	0.16	B	20.99
CA566	CC840	CC853		DC2070	16.5	x	10.9	x	7.0	15.0	x	9.3	x	7.0	0.51	C	35.39
CA567	CC842	CC855		DC3050	22.4	x	17.4	x	5.0	20.3	x	15.3	x	5.0	0.79	D	41.39

	Model No.	Divider Type	Maximum # of Dividers	Price /Each
A.	CA568	Short	7	2.36
A.	CA571	Long	5	2.57
B.	CA571	Short	11	2.57
B.	CA577	Long	7	3.76
C.	CA575	Short	11	5.80
C.	CA581	Long	7	6.35
D.	CA584	Short	15	5.26
D.	CA588	Long	11	5.69

### ACCESSORIES

	Clear Lids Model No.	Price /Each	Card Holders Model No.	Price /Each
A.	CA556	18.89	CC314	4.99
B.	CA561	24.29	CC314	4.99
C.	CA561	24.29	CA446/CC314	2.79

## DIVIDER BOX® CONTAINERS

- Made of FDA compliant materials
- Large, flat areas on all four sides for content identification
- Comfort grip handle
- Stacking rims and multi-ribbed external sides provide high impact strength
- All containers can be divided into compartments by length and/or width
- Moulded-in stacking ridge assures containers will stack securely with or without covers
- Full range of optional accessories available including hook and loop card holders, short and long dividers and covers
- Can be divided into subdivisions as small as 1 1/8" squares



Grey	Model No.			Mfg. No.	Dimensions					Volume Cu. Ft.	Uses Dividers & Accessories	Price /Each					
	Red	Blue			L"	x	W"	x	H"				L"	x	W"	x	H"
CF947	CF948	CF946		DG91025	10.9	x	8.3	x	2.5	9.2	x	6.6	x	2.0	0.38	A	11.50
CC641	CC934	CC946		DG91035	10.9	x	8.3	x	3.5	9.2	x	6.6	x	3.0	0.10	B	12.90
CC642	CC935	CC947		DG91050	10.9	x	8.3	x	5.0	9.2	x	6.6	x	4.5	0.19	C	13.90
CC643	CC936	CC948		DG92035	16.5	x	10.9	x	3.5	14.9	x	9.3	x	3.0	0.24	D	17.90
CF951	CF952	CF950		DG92050	16.5	x	10.9	x	5.0	14.9	x	9.3	x	4.5	1.71	E	20.90
CC644	CC937	CC949		DG92060	16.5	x	10.9	x	6.0	14.9	x	9.3	x	5.5	0.44	F	22.50
CC645	CC938	CC950		DG92080	16.5	x	10.9	x	8.0	14.9	x	9.3	x	7.5	0.60	G	27.50
CC646	CC939	CC951		DG93030	22.5	x	17.5	x	3.0	20.6	x	15.6	x	2.5	0.44	H	31.90
CC647	CC940	CC952		DG93060	22.5	x	17.5	x	6.0	20.6	x	15.6	x	5.5	0.97	I	40.50
CC648	CC941	CC953		DG93080	22.5	x	17.5	x	8.0	20.6	x	15.6	x	7.5	1.32	J	42.50
CC649	CC942	CC954		DG93120	22.5	x	17.5	x	12.0	20.6	x	15.6	x	11.5	2.03	K	52.50

### VERTICAL DIVIDERS

	Model No.	Divider Type	Maximum # of Dividers	Price/Each
A.	CF959	Short	7	3.39
A.	CF954	Long	5	3.29
B.	CC659	Short	7	2.86
B.	CC650	Long	5	2.54
C.	CC660	Short	7	1.88
C.	CC651	Long	5	2.71
D.	CC661	Short	11	2.54
D.	CC652	Long	7	3.75
E.	CF955	Short	11	3.99
E.	CF960	Long	7	10.90
F.	CC662	Short	11	3.38
F.	CC653	Long	7	4.46
G.	CC663	Short	11	4.63
G.	CC654	Long	7	4.55
H.	CC664	Short	15	4.55
H.	CC655	Long	11	5.04
I.	CC665	Short	15	4.65
I.	CC656	Long	11	11.90
J.	CC666	Short	15	6.07
J.	CC657	Long	11	6.86
K.	CC667	Short	15	11.30
K.	CC658	Long	11	12.50

### ACCESSORIES

	Clear Lids Model No.	Price /Each	Card Holders Model No.	Price /Each
A.	CD437	9.02	CF351	4.45
B.	CD437	9.02	CF351	4.45
C.	CD437	9.02	CF352	4.75
D.	CD438	12.70	CF351	4.45
E.	CD438	12.70	CF532	12.90
F.	CD438	12.70	CF532	12.90
G.	CD438	12.70	CF353	4.98
H.	CD439	23.90	CF351	4.45
I.	CD439	23.90	CF352	4.75
J.	CD439	23.90	CF353	4.98
K.	CD439	23.90	CF353	4.98



## ALL-PURPOSE STORAGE TUB

- All tubs are super easy to clean and dishwasher safe
- Virgin grade materials afford lifetime protection against bacteria, mold, mildew, and product degradation
- All-purpose tubs provide a storage, cleaning, and transportation solution for multiple applications
- Built-in handles are ergonomically designed for comfortable and easy grip and handling
- All tubs nest when empty saving valuable workspace
- Product is recyclable



CG218



Model No.	Mfg. No.	Description	Height"	Depth"	Length"	Colour	Price /Each
CG190	FSB-1295BK	All-Purpose Storage Tub	5-1/8	9-1/16	12-1/16	Black	14.30
CG191	FSB-1295BN	All-Purpose Storage Tub	5-1/8	9-1/16	12-1/16	Brown	14.30
CG192	FSB-1295GY	All-Purpose Storage Tub	5-1/8	9-1/16	12-1/16	Grey	14.30
CG196	FSB-20113BK	All-Purpose Storage Tub	3-3/4	11-3/8	20-7/16	Black	23.00
CG197	FSB-20113BN	All-Purpose Storage Tub	3-3/4	11-3/8	20-7/16	Brown	23.00
CG198	FSB-20113GY	All-Purpose Storage Tub	3-3/4	11-3/8	20-7/16	Grey	23.00
CG193	FSB-1544BK	All-Purpose Cutlery Storage Tub	4-1/8	4-7/16	14-3/16	Black	6.81
CG194	FSB-1544BN	All-Purpose Cutlery Storage Tub	4-1/8	4-7/16	14-3/16	Brown	6.81
CG195	FSB-1544GY	All-Purpose Cutlery Storage Tub	4-1/8	4-7/16	14-3/16	Grey	6.81
CG199	FSB-20155BK	All-Purpose Flat-Bottom Storage Tub	5	15	20	Black	23.00
CG201	FSB-20155GY	All-Purpose Flat-Bottom Storage Tub	5	15	20	Grey	23.40
CG206	FSB-21155BK	All-Purpose Flat-Bottom Storage Tub	5	15	21	Black	27.50
CG207	FSB-21155BN	All-Purpose Flat-Bottom Storage Tub	5	15	21	Brown	27.50
CG208	FSB-21155GY	All-Purpose Flat-Bottom Storage Tub	5	15	21	Grey	27.50
CG212	FSB-21157BK	All-Purpose Flat-Bottom Storage Tub	7	15	21	Black	30.00
CG213	FSB-21157BN	All-Purpose Flat-Bottom Storage Tub	7	15	21	Brown	30.00
CG214	FSB-21157GY	All-Purpose Flat-Bottom Storage Tub	7	15	21	Grey	30.00
CG221	FSB-22175BK	All-Purpose Flat-Bottom Storage Tub	5	17	22	Black	26.90
CG222	FSB-22175BN	All-Purpose Flat-Bottom Storage Tub	5	17	22	Brown	26.90
CG223	FSB-22175GY	All-Purpose Flat-Bottom Storage Tub	5	17	22	Grey	26.90
CG228	FSB-20155BN	All-Purpose Flat-Bottom Storage Tub	5	15	20	Brown	23.40
CG202	FSB-20155RBK	All-Purpose Ribbed-Bottom Storage Tub	5	15	20	Black	23.40
CG203	FSB-20155RBL	All-Purpose Ribbed-Bottom Storage Tub	5	15	20	Blue	23.40
CG204	FSB-20155RBN	All-Purpose Ribbed-Bottom Storage Tub	5	15	20	Brown	23.40
CG205	FSB-20155RGY	All-Purpose Ribbed-Bottom Storage Tub	5	15	20	Grey	23.40
CG209	FSB-21155RBK	All-Purpose Ribbed-Bottom Storage Tub	5	15	21	Black	27.40
CG210	FSB-21155RBN	All-Purpose Ribbed-Bottom Storage Tub	5	15	21	Brown	27.40
CG211	FSB-21155RGY	All-Purpose Ribbed-Bottom Storage Tub	5	15	21	Grey	27.40
CG215	FSB-21157RBK	All-Purpose Ribbed-Bottom Storage Tub	7	15	21	Black	30.00
CG216	FSB-21157RBN	All-Purpose Ribbed-Bottom Storage Tub	7	15	21	Brown	30.00
CG217	FSB-21157RGY	All-Purpose Ribbed-Bottom Storage Tub	7	15	21	Grey	30.00
CG224	FSB-22177RBK	All-Purpose Ribbed-Bottom Storage Tub	7	17	22	Black	31.80
CG225	FSB-22177RBL	All-Purpose Ribbed-Bottom Storage Tub	7	17	22	Blue	31.80
CG226	FSB-22177RBN	All-Purpose Ribbed-Bottom Storage Tub	7	17	22	Brown	31.80
CG227	FSB-22177RGY	All-Purpose Ribbed-Bottom Storage Tub	7	17	22	Grey	31.80
CG218	FSB-21165BK	All-Purpose Compartmentalized Storage Tub	7	15	20	Black	33.80
CG219	FSB-21165BN	All-Purpose Compartmentalized Storage Tub	5	15	20	Brown	33.80
CG220	FSB-21165GY	All-Purpose Compartmentalized Storage Tub	5	15	20	Grey	33.80

## ESD DIVIDER BOXES

- Provide conductive and shielding protection for use in electronics manufacturing
- All boxes can be divided into compartments by length and/or width
- Dividers are on 1.25" centres
- Made of permanently conductive black, carbon-filled, injection molded polypropylene copolymer resin
- A Faraday cage is created when used with ESD safe divider box covers
- Unaffected by washing or humidity
- Static decay rate from 5000 volts to 0 of less than two seconds
- Surface resistivity of < 1.0 x 10<sup>5</sup> ohms/square



Model No.	Outside Dim. Top		Outside Dim. Bottom		Overall Height"	Vol. Cu. Ft.	Wt. lbs.	Price /Each	Short Dividers			Long Dividers			Covers	
	L"	x W"	L"	x W"					Model No.	Max. Dividers	Price /Each	Model No.	Max. Dividers	Price /Each	Model No.	Price /Each
<b>CONDUCTIVE BINS</b>																
CB935	10.8	x 8.3	9.8	x 7.3	2.5	0.07	0.5	28.89	CB938	7	4.19	CB939	5	4.52	CB911	14.99
CB936	10.8	x 8.3	9.8	x 7.3	3.5	0.11	0.7	32.19	CB940	7	4.52	CB942	5	5.38	CB911	14.99
CB909	10.8	x 8.3	9.8	x 7.3	5	0.16	0.9	39.19	CB907	7	5.16	CB908	5	6.34	CB911	14.99
CB910	16.5	x 10.9	15.5	x 9.9	2.5	0.16	1.0	42.39	CB939	11	4.52	CB945	7	5.48	CB923	30.09
CB913	16.5	x 10.9	15.5	x 9.9	3.5	0.24	1.1	45.69	CB942	11	5.38	CB947	7	8.28	CB923	30.09
CB914	16.5	x 10.9	15.5	x 9.9	5	0.36	1.4	52.49	CB908	11	6.34	CB924	7	11.39	CB923	30.09
CB915	16.5	x 10.9	15.5	x 9.9	6	0.43	1.6	55.69	CB925	11	9.68	CB926	7	11.79	CB923	30.09
CB937	16.5	x 10.9	15.5	x 9.9	7.0	0.51	1.9	68.59	CB941	11	10.39	CB943	7	13.49	CB923	30.09
CB916	16.5	x 10.9	15.5	x 9.9	8	0.59	2	72.89	CB927	11	11.39	CB928	7	14.99	CB923	30.09
CB912	22.4	x 17.4	20.9	x 15.9	5	0.79	2.8	99.29	CB944	15	11.29	CB946	11	12.39	CB921	51.19
CB917	22.4	x 17.4	20.9	x 15.9	6	0.97	3.0	113.00	CB929	15	12.39	CB930	11	14.59	CB921	51.19
CB918	22.4	x 17.4	20.9	x 15.9	8	1.32	4.0	134.00	CB931	15	13.89	CB934	11	17.79	CB921	51.19
CB919	22.4	x 17.4	20.9	x 15.9	12	2	6	156.00	CB932	15	28.99	CB933	11	30.09	CB921	51.19

# CONTAINERS

## QUANTUB NESTING TOTES

- High-density polyethylene
- Rolled top rim for comfortable grip
- Six 1/4" position drill holes on bottom allow for drainage
- Dimensions: 24 1/2" L x 19" W x 9 1/2" H
- Injection molded high-density polypropylene
- FDA compliant materials



Model No.	Colour	Price /Each
CD244	Grey	43.90
CD434	Blue	43.90

## CROSS STACK BINS

- Ideal for production, assembly and order picking
- Injection molded from high impact polypropylene; will not crack or rust, and easy to clean
- Can be turned 90° to cross stack
- Built-in handle and bottom grooves for easy handling
- Capacity: 100 lbs.
- FDA approved
- Optional clear label holder CC360
- Drill hole pattern on bottom can be opened for drainage purposes



BINS				LIDS			
Model No.	Dimensions	Price	Model No.	Price			
Blue	Grey	White	L" x W" x H	/Each			
CD583	CD584	CD585	17 1/4 x 11 x 12	25.50			
CD247	CD246	CD248	25 1/8 x 16 x 8 1/2	34.50			
CF016	CD586	CF017		16.90			
CF018	CD606	CF019		24.50			

## BUS/UTILITY BOXES

- USDA Meat and Poultry Equipment Group Listed and assists in complying w/HACCP guidelines
- Made of durable, commercial grade plastic
  - Reinforced handles, bottom and ribs for added strength
  - Capacity: 17.5 L
  - 20" L x 15" W x 5" H
  - Grey

Model No. CD445  
Price/Each 15.60

### COVER

Model No. CD662  
Price/Each 20.90



## AGRICULTURAL PLASTIC STACK-N-NEST CONTAINER

- Used for field harvest, in-plant handling, staging and processing of fruits and vegetables
- High quality, impact resistant, durable and reusable hand-held container
- Ventilated design can easily be cleaned and sanitized
- Ideal for moist environments
- Stacks securely with bail arm engaged
- Fits 4-up on standard 40 x 48 pallets
- Nests when empty
- Material: Plastic
- FDA approved
- Fully recyclable
- Colour: Beige



Model No.	Mfg. No.	Overall Dim. W" x D" x H"	Bottom dim L" x W"	Inside Top Dim. L" x W"	Inside Bottom Dim. L" x W"	Price /Each
CF926	AF-1	20.3 x 24 x 6.8	21.4 x 17.8	22.5 x 19	20.9 x 17.5	51.69
CF927	AF-21	20 x 24 x 13.4	21.3 x 17.9	22.4 x 19	20.7 x 17.3	70.89

## AGRICULTURAL PLASTIC STACK-N-NEST CONTAINER

- High quality, impact resistant, durable and reusable hand-held container
- Used in field harvesting
- Ventilated design can easily be cleaned and sanitized
- Stacks when full
- Nests when empty
- Fits 5-up on a standard 40 x 48 pallet
- Material: Plastic
- FDA approved
- Fully recyclable



Model No.	Mfg. No.	Overall Dim. W" x D" x H"	Bottom Dim. L" x W"	Inside Top Dim. L" x W"	Inside Bottom Dim. L" x W"	Price /Each
CF928	SNX2416-7	16 x 23.9 x 7.3	22.3 x 14.5	19.7 x 15.7	20.2 x 12.3	32.99

## AGRICULTURAL PLASTIC STACK-N-NEST CONTAINER

- High quality, impact resistant, durable and reusable hand-held container
- Used for field harvest, in-plant handling, staging and processing of fruits and vegetables
- Ventilated design can easily be cleaned and sanitized
- Material: Plastic
- FDA approved
- Nests when empty
- Colour: Green
- Fully recyclable



Model No.	Mfg. No.	Overall Dim. W" x D" x H"	Bottom Dim. L" x W"	Inside Top Dim. L" x W"	Inside Bottom Dim. L" x W"	Price /Each
CF929	AF2013-6	13.1 x 19.7 x 5.6	17.1 x 11.6	17 x 11.6	16.6 x 11.2	28.29
CF931	NPL654B	16 x 23.9 x 8.8	22.1 x 15.9	19.9 x 13.7	19.2 x 12.6	46.89

## PLASTIC DAIRY CASE

- Reusable case maintains its shape and performance through stacking, pressure washing and transportation
- Reinforced base and corners allows for cases to be stacked
- Universally compatible
- Fits 9-up on standard 40 x 40 dairy pallet
- Inside Dimensions: 12-1/10" L x 12-1/10" W
- Approvals: FDA-Approved
- Capacity: 40 lbs.
- Fully recyclable



Model No.	Mfg. No.	Overall Dim. H" x W" x D"	Price /Each
CF932	NPL004-BLACK	11 x 13-1/10 x 13-1/10	20.79

## NARROW-MOUTH BOTTLES

**NALGENE®**

- These sturdy all-purpose bottles offer a large variety of uses
- Guaranteed leakproof
- Max Temp.: 120°C/ 248°F
- Min.Temp.: -100°C/-148°F
- Lid included



Model No.	Size	Price /Each
HA887	1/4 oz.	1.69
HA888	1/2 oz.	1.79
HA881	1 oz.	1.89
HA882	2 oz.	1.99
HA883	4 oz.	2.49
HA884	8 oz.	3.29
HA885	16 oz.	4.49
HA886	32 oz.	7.99
<b>DROP DISPENSERS</b>		
HB233	1/2 oz.	3.49
HB234	1 oz.	5.29
HB235	2 oz.	5.99

## WIDE-MOUTH BOTTLES

- The larger Nalgene® wide-mouth bottles are great for almost anything
- Guaranteed leakproof
- Max. temp.: 120°C/248°F
- Lid included



**NALGENE®**

Model No.	Size	Price /Each
HB005	1 oz.	2.69
HB006	2 oz.	2.99
HB007	4 oz.	3.49
HB008	8 oz.	5.29
HC678	16 oz.	6.29
HC679	32 oz.	11.99
HB037	1/2 gal.	39.99
HB038	1 gal.	58.29

## EASY-GRIP SPACE-SAVER BOTTLES RECTANGULAR & SQUARE

**PERFECT FOR SOLIDS, POWDERS OR LIQUIDS!**

- Heavy-duty walls will not puncture or split under rough conditions
- Perfect for solids, powders or liquids
- Guaranteed leakproof
- Max Temp.: 120°C/248°F
- Min. Temp.: -100°C/-148°F
- Lid included



**NALGENE®**

Model No.	Size	Price /Each
<b>RECTANGULAR</b>		
HA902	4 oz.	2.69
HA903	8 oz.	3.89
HA904	16 oz.	6.29
HA905	32 oz.	10.99
HA906	64 oz.	22.90
<b>SQUARE</b>		
HB014	2 oz.	3.99
HB015	6 oz.	7.99
HB016	8 oz.	8.99
HB017	16 oz.	11.99
HB018	32 oz.	14.99

## ONE GALLON SQUARE BOTTLES

- Heavy-duty walls will not puncture or split under rough conditions
- This 1 gallon leakproof bottle is perfect for solids, powders or liquids
- The convenient wide mouth and handgrips make it easy to fill and pour contents
- Lid included

Model No. HB039  
Price/Each \$65.49



**NALGENE®**

## STRAIGHT-SIDED JARS

- These attractive canister-style jars are ideal for a wide variety of uses
- These jars lock out moisture to help preserve freshness
- Stackable and impact resistant
- Not recommended for liquid storage
- Max temp.: 135°C/275°F
- Min. temp.: -135°C/-211°F
- Lid included

Model No.	Size	Price /Each
HB025	1 oz.	2.99
HB026	2 oz.	3.29
HB027	4 oz.	5.69
HB028	8 oz.	9.29
HB029	16 oz.	11.29
HB030	32 oz.	12.99

**NALGENE®**





# MOVE, PACK, AND STOCK WITH **KLETON**

