

# SAFETY EQUIPMENT & SUPPLIES



Safety Eyewear .....	268-282
Face Protection .....	283-285
Hardhats .....	286-291
Headlamps .....	292
Hearing Protection .....	293
Earplugs .....	294-300
Earmuffs .....	301-304
Sound Level Meters.....	305
Disposable Respirators.....	306-311
Reusable Respirators .....	312-321
Elastomeric Respirators .....	322
Powered Air Purifying Respirators.....	323
Respirator Accessories .....	324
Environmental Meters.....	325
Gas Detectors .....	326-331
Fall Arrest & Rescue.....	332-356
Protective Clothing.....	357-369
General Rainwear.....	370-371
High Visibility Clothing.....	372-377
Outerwear .....	378-379
Welding Protection.....	380-391
Hand Protection.....	392-435
Foot Protection .....	436-441
Knee & Kneeling Pads.....	442-443
Braces & Supports.....	444-446
Heat Stress Prevention .....	447-450
Fire Extinguishing Products .....	451-453
Safety Cabinets.....	454-461
Safety Containers.....	462-465
Ashtrays.....	466
Spill Control Management Supplies .....	467-502
Emergency Shower & Eyewash.....	503-515
First Aid & Medical Equipment .....	516-535
Locks .....	536-549
Tags.....	550-554
Letter Punch .....	555
Signs .....	556-567
SDS.....	568-569
TDG .....	570-572
Traffic Safety .....	573-582
Anti-Skid Tape .....	583
Marking Tapes .....	584-587
Crowd Control.....	588-589
Safety & Inspection Mirrors.....	590-591



# SAFETY EYEWEAR

## Z2700 SERIES OTG SAFETY GLASSES

- OTG safety eyewear is designed to fit over regular prescription glasses
- Ratchet temple provides superior comfort and fit
- 99.9% UVA & UVB protection
- Frame Colour: Black
- Standard(s) Met: CSA Z94.3/ANSI Z87+



SGF734

Model No.	Lens Tint	Lens Coating	Price /Each
SGF734	Clear	Anti-Scratch	4.10
SGF735	Clear	Anti-Fog	5.35

## Z2900 SERIES SAFETY GLASSES

- Narrow fit is suited for smaller facial features
- Frameless design with extended wraparound coverage
- Scratch-resistant polycarbonate lens with UV protection
- Flexible temple design for added durability
- Non-slip rubber head grips
- Ultra soft snap-on, non-slip nosepiece provides extra comfort
- Near total seal of the eye provides superior protection
- Distortion-free
- Available with or without foam gasket
- Standard(s) Met: ANSI Z87+, CSA Z94.3



SGQ757



SGQ766

Model No.	Lens Tint	Lens Coating	Price /Each
SGQ757	Clear	Anti-Scratch	3.55
SGQ758	Grey/Smoke	Anti-Scratch	4.40
SGQ759	Amber	Anti-Scratch	3.60
SGQ760	Blue	Anti-Scratch	3.60
SGQ761	Indoor/Outdoor Mirror	Anti-Scratch	4.70
SGQ762	Clear	Anti-Fog	4.60

### WITH REMOVABLE FOAM GASKET

SGQ763	Clear	Anti-Scratch	6.75
SGQ764	Grey/Smoke	Anti-Scratch	8.35
SGQ765	Amber	Anti-Scratch	7.65
SGQ766	Blue	Anti-Scratch	7.65
SGQ767	Indoor/Outdoor Mirror	Anti-Scratch	8.95
SGQ768	Clear	Anti-Fog	8.80

## Z3000 SERIES SAFETY GLASSES

- Modern full frame design with extended wraparound coverage
- Scratch resistant polycarbonate lens with UV protection
- Ultra-soft non-slip nosepiece
- Black frame
- Distortion-free
- Standard(s) Met: CSA Z94.3, ANSI Z87+



SGU275

Model No.	Lens Tint	Lens Coating	Price /Each
SGU271	Clear	Anti-Scratch	4.45
SGU272	Grey/Smoke	Anti-Scratch	4.95
SGU273	Amber	Anti-Scratch	5.00
SGU274	Blue	Anti-Scratch	5.00
SGU275	Indoor/Outdoor Mirror	Anti-Scratch	5.20
SGU276	Clear	Anti-Fog/Anti-Scratch	5.80
SGU277	Grey/Smoke	Anti-Fog/Anti-Scratch	6.40

## Z3200 SERIES SAFETY GLASSES

- Scratch-resistant polycarbonate lens with UV protection
- Sporty design with extended wrap-around coverage
- Non-slip rubber head grips for increased user comfort
- Distortion-free lenses
- Ultra-soft non-slip nosepiece
- Standard(s) Met: CSA Z94.3, ANSI Z87+
- Lens Coating: Anti-Scratch



Model No.	Lens Tint	Price /Each
SGU582	Clear	2.85

## Z3300 SERIES SAFETY GLASSES

- Flexible front frame that helps alleviate pressure on the head
- Sporty and sleek frame design
- Co-injected temple pad will not peel off easily
- Polarized lenses for outdoor activities to reduce glare and to see sharper and clearer
- Standard(s) Met: CSA Z94.3, ANSI Z87+
- Lens Coating: Anti-Scratch



Model No.	Lens Tint	Price /Each
SGW884	Grey/Smoke	29.75

## Z3400 SERIES SAFETY GLASSES

- Sporty and translucent temple design
- Streamline temple arm for best comfort
- Dual-injected rubber at the end of the temple that will not peel off easily
- Anatomically-shaped nose-piece that will adapt to most face contours
- Polarized lenses for outdoor activities to reduce glare and to see sharper and clearer
- Standard(s) Met: CSA Z94.3, ANSI Z87+
- Lens Coating: Anti-Scratch



Model No.	Lens Tint	Price /Each
SGW885	Grey/Smoke	29.75

## Z3500 SERIES SAFETY GLASSES

- Sporty design
- Flexible and lightweight for all-day comfort
- Nosepiece features integrated ridges to divert sweat
- Features neck cord to reduce risk of damage when not being worn
- Ideal for indoor use
- Distortion-free lenses
- Scratch-resistant polycarbonate lens with UV protection
- Standard(s) Met: CSA Z94.3, ANSI Z87+



SGY576

Model No.	Lens Tint	Lens Coating	Price /Each
SGY575	Clear	Anti-Scratch	5.85
SGY576	Grey, Smoke Mirror	Anti-Scratch	5.20



## Z900 SERIES SAFETY GLASSES

- Modern design with extended wrap-around coverage
- Scratch-resistant polycarbonate lens with UV protection
- Non-slip rubber head grips
- Ultra-soft non-slip nosepiece
- Distortion-free
- Beige frame
- Compliant with CSA standard Z94.3



Model No.	Lens Tint	Price /Each
SAX444	Clear	5.50

## Z1400 SERIES SAFETY GLASSES

- Modern design with extended wraparound coverage
- Scratch-resistant polycarbonate lens with UV protection
- Ultra soft non-slip nosepiece
- Distortion-free
- Black frame
- Compliant with CSA standard Z94.3



Model No.	Lens Tint	Lens Coating	Price /Each
SEC954	Clear	Anti-Scratch	4.70
SGF246	Clear	Anti-Fog/Anti-Scratch	6.10

## Z1000 SERIES SAFETY GLASSES

- Frameless design with extended wrap-around coverage
- Non-slip rubber head grips
- Ultra-soft non-slip nosepiece
- Scratch-resistant polycarbonate lens with UV protection
- Distortion-free
- Compliant with CSA standard Z94.3



Model No.	Lens Tint	Price /Each
SAX445	Clear	4.65

## Z1500 SERIES SAFETY GLASSES

- Modern design with extended wraparound coverage
- Scratch-resistant polycarbonate lens with UV protection
- Ultra soft non-slip nosepiece
- Distortion-free
- White frame
- Compliant with CSA standard Z94.3



Model No.	Lens Tint	Price /Each
SEC955	Clear	5.40
SEI524	Grey/Smoke	6.10
SEI525	Amber	6.10
SEI526	Blue	6.10
SEI527	I/O Mirror	6.60
SEI528	Clear w/Anti-Fog	6.95



## Z1200 SERIES SAFETY GLASSES

- Sporty design frame with extended wraparound coverage
- Scratch-resistant polycarbonate lens with UV protection
- Non-slip, extremely flexible, rubber temples provide superior comfort and fit
- Ultra soft non-slip nosepiece
- Distortion-free
- Black frame
- Includes a clip for Rx inserts
- Compliant with CSA standard Z94.3



Model No.	Lens Tint	Price /Each
SEC952	Clear	6.25

## Z1600 SERIES SAFETY GLASSES

- Modern design with extended wrap around coverage
- Scratch-resistant polycarbonate lens with UV protection
- Ultra soft non-slip nosepiece
- Extendable and ratchet temple provides superior comfort and fit
- Distortion-free
- Black frame
- Compliant with standard CSA Z94.3



Model No.	Lens Tint	Price /Each
SEE817	Clear	6.40

## Z1300 SERIES SAFETY GLASSES

- Modern design with extended wraparound coverage
- Scratch-resistant polycarbonate lens with UV protection
- Non-slip rubber temples provide superior comfort and fit
- Ultra soft non-slip nosepiece
- Distortion-free
- Black frame
- Compliant with CSA standard Z94.3



Model No.	Lens Tint	Price /Each
SEC953	Clear	5.10

## Z1800 SERIES SAFETY GLASSES

- Readers Lens
- Sporty design with extended wraparound coverage
- Scratch resistant polycarbonate lens with UV protection
- Ultra-soft non slip nosepiece
- Adjustable temples provide a superior comfort and fit
- Black frame
- Distortion-free
- Compliant with CSA standard Z94.3.



Model No.	Lens Tint	Diopter	Price /Each
SEH013	Clear	1.0	9.90
SEH014	Clear	1.5	9.90
SEH015	Clear	2.0	9.90
SEH016	Clear	2.5	9.90



# SAFETY EYEWEAR

## Z1900 SERIES SAFETY GLASSES

- Modern design with extended wraparound coverage
- Scratch-resistant polycarbonate lens with UV protection
- Ultra soft non-slip nosepiece
- Distortion-free
- Compliant with CSA standard Z94.3



Model No.	Lens Tint	Price /Each
SEH632	Clear	5.60
SEK286	Grey/Smoke	6.15
SEK287	Amber	6.35
SEK288	Blue	6.50
SEK289	I/O Full Mirror	6.55
SEK290	Clear Anti-Fog	7.30



## Z2000 SERIES SAFETY GLASSES

- Sporty design with extended wraparound coverage
- Non-slip, extremely flexible temples provide superior comfort and fit
- Ultra soft non-slip nosepiece
- Scratch-resistant polycarbonate lens with UV protection
- Green frame
- Compliant with CSA standard Z94.3



Model No.	Lens Tint	Price /Each
SEK291	Clear	4.80
SDN697	Grey/Smoke	5.30
SDN698	Amber	5.40
SDN699	I/O Mirror	5.60
SDN700	Clear Anti-Fog	6.25

## Z2100 SERIES SAFETY GLASSES

- Modern design with extended wraparound coverage
- Ratchet temples provide superior comfort and fit
- Ultra soft non-slip nosepiece
- Scratch-resistant polycarbonate lens with UV protection
- Clear frame
- Compliant with CSA standard Z94.3



Model No.	Lens Tint	Price /Each
SEK292	Clear	3.05

## Z2200 SERIES SAFETY GLASSES

- Modern design with extended wraparound coverage
- Flexible temples provide superior comfort and fit
- Scratch-resistant polycarbonate lens with UV protection
- Distortion-free
- Clear frame
- Compliant with CSA standard Z94.3



Model No.	Lens Tint	Price /Each
SEK293	Clear	2.15
SGF245	Clear Anti-Fog	2.85

## Z2400 SERIES SAFETY GLASSES

- Frameless design with extended wraparound coverage
- Scratch-resistant polycarbonate lens with UVA/UVB protection
- The safety glasses have non-slip rubber head grips for increased user comfort
- Flexible temple for added durability and flexibility to the frame
- Distortion-free lenses
- Compliant to CSA standard Z94.3 and ANSI Z87+



Model No.	Lens Tint	Lens Coating	Price /Each
SET315	Clear	Anti-Scratch	2.10
SET316	Grey/Smoke	Anti-Scratch	2.80
SET317	Amber	Anti-Scratch	2.40
SET318	Blue	Anti-Scratch	2.40
SET319	I/O Blue Mirror	Anti-Scratch	3.75
SET320	Clear	Anti-Fog	3.25
SGQ770	Grey/Smoke	Anti-Fog	3.85

## Z2500 SERIES SAFETY GLASSES

- Sporty design with extended wraparound coverage
- Scratch resistant polycarbonate lens with UV protection
- Non-slip, extremely flexible temples provide superior comfort and fit
- Distortion-free
- Available with or without foam gasket
- Compliant to CSA standard Z94.3 and ANSI Z87+



Model No.	Lens Tint	Lens Coating	Price /Each
SDN701	Clear	Anti-Scratch	2.95
SDN702	Grey/Smoke	Anti-Scratch	3.25
SDN703	Amber	Anti-Scratch	3.35
SDN704	Blue	Anti-Scratch	3.35
SDN705	Indoor/Outdoor Mirror	Anti-Scratch	3.45
SDN706	Clear	Anti-Fog	3.85



### WITH REMOVABLE FOAM GASKET

SDN707	Clear	Anti-Scratch	4.65
SDN708	Grey/Smoke	Anti-Scratch	5.10
SDN709	Indoor/Outdoor Mirror	Anti-Scratch	5.45
SDN710	Clear	Anti-Fog	5.65

## Z2600 SERIES SAFETY GLASSES

- Narrow fit is suited for smaller facial features
- Frameless design with extended wraparound coverage
- Scratch-resistant polycarbonate lens with UV protection
- Flexible temple design for added durability
- Non-slip rubber head grips
- Near total seal of the eye provides superior protection
- Distortion-free
- Compliant to CSA standard Z94.3 and ANSI Z87+



Model No.	Lens Tint	Lens Coating	Price /Each
SGF150	Clear	Anti-Scratch	2.30
SGF151	Grey/Smoke	Anti-Scratch	2.75
SGF152	Clear	Anti-Fog/Anti-Scratch	3.25



## Z100 SERIES SAFETY GLASSES

- Traditional design with integral sideshields
- Scratch-resistant polycarbonate lens with UV protection
- Extendable and ratchet temple provides superior comfort and fit
- Molded-in nose bridge
- Distortion-free
- Black frame
- Compliant with CSA standard Z94.3



Model No.	Lens Tint	Lens Coating	Price /Each
SEH642	Clear	Anti-Scratch	2.55
SGF244	Clear	Anti-Fog/Anti-Scratch	3.70

## Z600 SERIES SAFETY GLASSES

- Frameless design with extended wraparound coverage
- Scratch-resistant polycarbonate lens with UV protection
- Flexible temple design for added durability
- Near total seal of the eye provides superior protection
- Distortion-free
- Compliant with CSA standard Z94.3 and ANSI Z87+



Model No.	Lens Tint	Lens Coating	Price /Each
SAW920	Clear	Anti-Scratch	2.10
SGF241	Clear	Anti-Fog/Anti-Scratch	2.85
SGF242	Grey/Smoke	Anti-Scratch	2.30

## Z200 SERIES SAFETY GLASSES

- Superior protection at an economical price
- Polycarbonate lens with UV protection
- Ideal visitor spectacle
- Molded-in nose bridge
- Distortion-free
- Compliant with CSA standard Z94.3



Model No.	Lens Tint	Lens Coating	Price /Each
SEF024	Clear	Anti-Scratch	2.10
SGF243	Clear	Anti-Fog/Anti-Scratch	3.50

## Z700 SERIES SAFETY GLASSES

- Frameless design with extended wrap-around coverage
- Scratch-resistant polycarbonate lens with UV protection
- Ultra-soft non-slip nosepiece
- Flexible temple provides added durability
- Distortion-free
- Compliant with CSA standard Z94.3



Model No.	Lens Tint	Lens Coating	Price /Each
SAX442	Clear	Anti-Scratch	3.15
SFU769	Clear	Anti-Fog/Anti-Scratch	4.10
SFU768	Grey/Smoke	Anti-Scratch	3.45

## Z400 SERIES SAFETY GLASSES

- Sporty design with extended wraparound coverage
- Scratch-resistant polycarbonate lens with UV protection
- Adjustable temples provide a superior comfort and fit
- Ultra-soft non-slip nosepiece
- Distortion-free
- Black frame
- Compliant with CSA standard Z94.3



Model No.	Lens Tint	Price /Each
SAK850	Clear	4.75
SAK851	Grey/Smoke	4.95

## Z800 SERIES SAFETY GLASSES

- Sporty design with extended wrap-around coverage
- Scratch-resistant polycarbonate lens with UV protection
- Extendable temple provides superior comfort and fit
- Molded-in nose bridge
- Distortion-free
- Blue frame
- Compliant with CSA standard Z94.3



Model No.	Lens Tint	Price /Each
SAX443	Clear	4.35

## Z500 SERIES SAFETY GLASSES

- Frameless design with extended wraparound coverage
- Scratch-resistant polycarbonate lens with UV protection
- Non-slip rubber head grips
- Distortion-free
- Compliant with CSA standard Z94.3 and ANSI Z87+

Model No.	Lens Tint	Price /Each
SAP877	Clear	2.15
SAS362	Grey/Smoke	2.55
SAS363	Amber	2.55
SAS364	Blue	2.55
SEB183	Clear Anti-fog	3.45
SGQ769	Grey/Smoke Anti-fog	3.55
SEA551	I/O Blue Mirror	3.70
SEE955	Orange	2.55



# SAFETY EYEWEAR

## Z9800 SERIES SAFETY GLASSES

- Frameless sporty design with extended wraparound coverage
- Scratch-resistant polycarbonate lens with UV protection
- Flexible temple design for added durability
- Near total seal of the eye provides superior protection
- Distortion-free
- Frame: Clear
- Standard(s) Met: CSA Z94.3/ANSI Z87+



Produits de sécurité  
**ZENITH** <sup>MP</sup>

Model No.	Lens Tint	Lens Coating	Price /Each
SGI622	Clear	Anti-Scratch	2.45
SGI623	Smoke	Anti-Scratch	2.70
SGI624	Clear	Anti-Fog	3.20

## Z3600 ECO SERIES SAFETY GLASSES

- Flexible nylon frame features a special streamlined designed for a more comfortable fit than normal dual-lens models
- Flexible and lightweight for all-day comfort
- Simple but classic dual frame design with unique diamond-cut curvature
- Ideal for professional and at-home users
- Both the environmentally friendly frame and plastic packaging are made from recycled materials
- Distortion-free lenses
- Standard(s) Met: ANSI Z87+/CSA Z94.3
- Frame Colour: Black



Produits de sécurité  
**ZENITH** <sup>MP</sup>

Model No.	Lens Tint	Lens Coating	Price /Each
SGZ359	Clear	Anti-Scratch	5.95

## GENESIS® SAFETY GLASSES

- Lightweight, extremely resilient external polycarbonate frame
- Soft elastomer internal frame
- Interchangeable dual 9 base wraparound lens
- Vents the eye socket area
- Soft brow bumper provides comfortable fingers that adjust and wraparound almost any nasal profile
- Ratchet lens inclination adjustment
- Passed military V0 ballistic (standard MIL-STD-662) test regiment
- Available with high performance Ultra-Dura® anti-scratch, Durastreme® dual anti-fog/anti-scratch, and HydroShield™ anti-fog lens coatings as well as a wide range of lens tints
- Standard(s) Met: CSA Z94.3



**Honeywell**  
**UVEX**

Model No.	Mfg. No.	Lens Tint/Coating	Frame Colour	Price /Each
SN209	S3200	Clear Ultra-Dura® HC	Black	14.60
SDL049	S3200HS	Clear Hydroshield™	Black	16.10
SN211	S3201	Espresso Ultra-Dura®	Black	16.70
SDL050	S3201HS	Espresso Hydroshield™	Black	18.60
SN219	S3240	Clear Ultra-Dura® HC	Blue	14.60
SN221	S3241	Espresso Ultra-Dura® HC	Blue	16.70

## SEISMIC® SAFETY GLASSES

- Protection against impact, sun, wind, dust and debris
- Soft and flexible nasal pads conform to a variety of facial profiles and minimize slippage
- Soft, high quality face cushioning and padded temple tips offer all-day comfort
- Adjustable flame-resistant headband provides excellent fit
- Replaceable flame-resistant, cushion-lined subframe extends the life of the eyewear
- Headband and cushion-lined subframe are latex-free
- Meets the requirements of the CSA Z94.3 standard only with subframe in place
- Available with high performance Uvextra® anti-fog coatings and a scratch-resistant hardcoat



**Honeywell**  
**UVEX**

Model No.	Mfg. No.	Frame Colour	Lens Tint/Coating	Price /Each
SBA822	S0600	Black	Clear/Hardcoat	23.80
SBA831	S0624X	Blue	SCT-Reflect 50	31.30

## AVATAR™ SAFETY GLASSES

- Designed for maximum all-day comfort and customizable fit
- Soft wire-core ratchet temples help adapt the glasses to face
- Offers protection without hindering peripheral vision
- Flexible nose pads help reduce slippage
- Indirect venting system
- Standard(s) Met: CSA Z94.3/ANSI Z87+



**Honeywell**  
**UVEX**

Model No.	Mfg. No.	Frame Color	Lens Tint	Lens Coating	Price /Each
SGG273	S2850HS	Black	Clear	Anti-Fog/Anti-Scratch	17.70
SGF600	S2851HS	Black	Grey/Smoke	Anti-Fog/Anti-Scratch	18.60
SGG274	S2852HS	Black	Amber	Anti-Fog/Anti-Scratch	18.60
SGG275	S2854	Black	SCT-Reflect 50	Anti-Scratch	16.70
SGG276	S2853	Black	Blue/Mirror	Anti-Scratch	16.70
SGG277	S2860HS	Red	Clear	Anti-Fog/Anti-Scratch	19.10
SGG287	S2860	Red	Clear	Anti-Scratch	15.70
SGG278	S2861HS	Red	Grey/Smoke	Anti-Fog/Anti-Scratch	19.40
SGG279	S2864	Red	SCT-Reflect 50	Anti-Scratch	16.70
SGF599	S2870HS	Blue	Clear	Anti-Fog/Anti-Scratch	18.30
SGG288	S2870	Blue	Clear	Anti-Scratch	15.70
SGG281	S2871HS	Blue	Grey/Smoke	Anti-Fog/Anti-Scratch	19.40
SGG282	S2873	Blue	Blue/Mirror	Anti-Scratch	16.10
SGG283	S2880HS	Teal	Clear	Anti-Fog/Anti-Scratch	19.10
SGG284	S2881HS	Teal	Grey/Smoke	Anti-Fog/Anti-Scratch	18.60
SGG285	S2884	Teal	SCT-Reflect 50	Anti-Scratch	16.10



## SVP 200 SERIES SAFETY GLASSES

- Dielectric, 10 base wraparound lens offers optimum protection
- Frameless, very lightweight and low-profile at 15 grams – perfect for all-day wear and fits most facial profiles
- Temple tips are flexible and comfortable
- Molded nosepiece
- Polycarbonate lens
- Standard(s) Met: CSA Z94.3/ANSI Z87+



**Honeywell**  
UVEX

Model No.	Mfg. No.	Frame Color	Lens Tint	Lens Coating	Price /Each
SGG290	SVP200	Clear	Clear	Anti-Scratch	2.39
SGG291	SVP201	Clear	Clear	Anti-Fog	2.86
SGG292	SVP202	Grey	Grey/Smoke	Anti-Scratch	2.45
SGG293	SVP203	Grey	Grey/Smoke	Anti-Fog	2.91
SGG294	SVP204	Amber	Amber	Anti-Fog	3.03
SGG295	SVP205	Blue	Clear	Anti-Fog	2.88
SGG296	SVP206	Blue	Blue/Mirror	Anti-Scratch	4.57
SGG297	SVP207	Blue	Indoor/Outdoor	Anti-Scratch	3.97
SGG298	SVP208	Pink	Clear	Anti-Fog	2.91

## A700 SERIES SAFETY GLASSES

- Lightweight design with sport temples
- Soft temple tip pads provide a secure, comfortable fit
- Moulded universal nose bridge
- Provides 99.9% UV protection



**Honeywell**  
UVEX

Model No.	Mfg. No.	Frame Colour	Lens Tint/Coating	Price /Each
SAO669	A700	Clear	Clear/Hardcoat	3.51
SAO670	A701	Grey	TSR® Grey/Hardcoat	3.88
SAO672	A703	Grey	Blue Mirror/Hardcoat	5.63
SAO673	A704	Grey	I/O Silver Mirror/Hardcoat	5.63
SAO674	A705	Clear	Clear Fog-Ban®	4.53

## PROTÉGÉ SAFETY GLASSES

- Proprietary Floating Lens™ design offers increased flexibility for better fit
- Secure wraparound brow expands to fit a wide range of users
- Ultra lightweight design
- Soft temple tip pads provide a secure, comfortable fit
- Soft, clear nose pads prevent slipping
- Compliant with ANSI standard Z87+
- Lifetime frame guarantee
- Available with high performance Ultra-Dura® anti-scratch and HydroShield™ anti-fog lens coatings
- Standard(s) Met: CSA Z94.3/ANSI Z87+



**Honeywell**  
UVEX

Model No.	Mfg. No.	Frame Colour	Lens Tint	Price /Each
<b>ULTRA-DURA® HARDCOAT</b>				
SA0659	S4200	Black	Clear	8.62
SA0661	S4202	Black	SCT-Reflect 50	13.10
<b>HYDROSHIELD™ ANTI-FOG</b>				
SDL053	S4200HS	Black	Clear	9.89
SDL054	S4201HS	Black	Grey	11.40

## TIRADE® SAFETY GLASSES

- Indirect ventilation channels on the foam and subframe provide superior dust filtration keeping debris out of the eyes
- Frameless, unilens design allows for wide-field peripheral vision
- Quick-release hinge system converts easily from temples to headband
- Removable temples and standard adjustable headband included
- Hypoallergenic latex-free option available
- 100% non-conductive dielectric design
- Uvextra® anti-fog coated lens reduces fogging, keeping lenses clear
- Ideal for use in oil, gas & chemical, utility, construction and manufacturing operations
- Meets the requirements of the CSA Z94.3 standard (with and without foam subframe in place)
- Standard(s) Met: CSA Z94.3/ANSI Z87+



**Honeywell**  
UVEX

Model No.	Mfg. No.	Lens Tint	Price /Each
SDL044	S4040	Clear	14.10
SDL045	S4041	Grey	14.10
SDL046	S4042	Amber	13.10
SDL047	S4043	Silver Mirror	15.30
SDL048	S4044	SCT-Reflect 50	16.40

# SAFETY EYEWEAR

## AVATAR™ OTG SAFETY GLASSES

- Over-the-Glass (OTG) safety glasses are an ideal solution for workers who wear corrective lenses, as they're simply worn over their own prescription eyewear
- Unlike most OTGs, weight is dispersed throughout the brow and the nose piece
- Multi-Material Technology™ Plus nose piece offers 3 vertical positions and flexes to most nose sizes to provide the ultimate comfort and fit
- Multi-Material Technology™ Plus (MMT+) is an innovative rubber compound that provides exceptional grip and comfort
- Angle-adjustable ratchet temples offer up to a 15° adjustment range for a better fit
- Insulated wire core temples provides increased adjustability, customizability, and non-conductivity
- Patented indirect venting technology significantly reduces fogging
- Lens Coating: Anti-Scratch
- Standard(s) Met: CSA Z94.3/ANSI Z87+



SG5402

**Honeywell**  
UVEX

Model No.	Mfg. No.	Frame Colour	Lens Tint	Price /Each
SG5401	S3850	Black	Clear	18.10
SG5402	S3851	Black & Red	Clear	19.80
SG5403	S3852	Black & Red	Grey	19.10

## ASTRO OTG® 3001 SAFETY GLASSES

- Same features as the Astrospec 3000® with attractive OTG (over-the-glass) styling
- An economical alternative to expensive Rx eyewear
- Lifetime frame guarantee
- Available with high performance Ultra-Dura® anti-scratch and Uvextreme® anti-fog coatings
- Standard(s) Met: CSA Z94.3



SE700

**Honeywell**  
UVEX

Model No.	Mfg. No.	Frame Colour	Lens Tint	Price /Each
UVEXTREME® AF				
SE700	S2500C	Black	Clear	17.00
SE702	S2510C	Blue	Clear	17.00
ULTRA-DURA® HARDCOAT				
SE704	S2500	Black	Clear	15.90
SE705	S2504	Black	Grey	18.20

## ULTRA-SPEC® SAFETY GLASSES

### ULTRA-SPEC® 1000

- Ideal visitor spec
- Uncoated 100% polycarbonate wraparound unilens design with solid side shields
- Standard(s) Met: CSA Z94.3/ANSI Z87+



SAG310

### ULTRA-SPEC® 2000

- Coated 100% polycarbonate wraparound unilens design
- Adjustable temple length
- Standard(s) Met: CSA Z94.3/ANSI Z87+



SE614

**Honeywell**  
UVEX

Model No.	Mfg. No.	Frame Colour	Lens Tint	Price /Each
ULTRA-SPEC® 1000 UNCOATED				
SAG310	S300CS	Clear	Clear	3.37
ULTRA-SPEC® 2000 UVEXTREME® AF				
SE614	S0250X	Clear	Clear	8.29

## ASTROSPEC 3000® SAFETY GLASSES

- Lightweight unilens offers panoramic vision
- Easy and economical lens replacement system
- Adjustable lens inclination and temple length
- Molded side shields
- Black frame
- Lifetime frame guarantee
- Available with high performance Ultra-Dura® anti-scratch and Uvextreme® anti-fog coatings
- Standard(s) Met: CSA Z94.3



SE622

**Honeywell**  
UVEX

Model No.	Mfg. No.	Lens Tint	Price /Each
ULTRA-DURA® HARDCOAT			
SE633	S1359	Clear	13.80
SE642*	S1111	Infra-Dura® 3.0	21.40
SE643*	S1112	Infra-Dura® 5.0	23.40
UVEXTREME® AF			
SE622	S1359C	Clear	15.10

\* Does not feature Duoflex® temples

## SECUREFIT™ 100 SERIES SAFETY GLASSES

- 3M's innovative temple design features slotted ribs that provide comfortable pressure equalization, allowing the temples to flex and self-adjust to the size of the wearer's head
- Curved temples apply pressure to the less sensitive back of the head, instead of the temples, achieving a comfortable fit even during rapid head movement
- Sporty design with contemporary lens shape and a sleek profile
- Adjustable ratchet temples allow user to adjust the lens for facial features and eyeglass position
- SecureFit's flat and flexible temple design combines well with 3M™ Protective Earmuffs
- Choose from models with anti-fog/anti-scratch or 3M™ Scotchgard™ Anti-Fog coating
- U6 rated polycarbonate lenses absorb 99.9% of UVA, UVB, and UVC rays between 200 nm and 380 nm
- Workers can feel confident wearing 3M eye protection that meets the Impact-Rated Protector requirement of the ANSI-ISEA Z87.1-2020 Standard
- Standard(s) Met: CSA Z94.3, ANSI Z87+
- Temple Colour: Black

Model No.	Mfg. No.	Lens Tint	Lens Coating	Price /Each
SGX038	SF101AF-BLK	Clear	Anti-Fog/Anti-Scratch	3.50
SGX037	SF101AS-BLK	Clear	Anti-Scratch	3.14
SGX036	SF102AF-BLK	Grey	Anti-Fog/Anti-Scratch	3.50
SGX035	SF107AF-BLK	Indoor/Outdoor, Grey	Anti-Fog/Anti-Scratch	3.50



SGX035

**3M**



## SECUREFIT™ 200 SERIES SAFETY GLASSES

- Patent-pending 3M™ Pressure Diffusion Temple Technology
- Versatile design is suited for a wide variety of faces
- Automatically self-adjust to provide a secure, comfortable fit each time
- Contemporary design weighs less than 1 oz. for lightweight comfort
- Polycarbonate lens absorbs 99.9% UVA & UVB
- Meets the requirements of CSA Z94.3 and ANSI Z87.1-2010



Model No.	Mfg. No.	Lens Tint	Lens Coating	Price /Each
SEK244	SF201AF-CA	Clear	Anti-Fog	4.50
SEK245	SF202AF-CA	Grey	Anti-Fog	4.50
SEK246	SF203AF-CA	Amber	Anti-Fog	4.50

## SECUREFIT™ 400 SERIES SAFETY GLASSES

- Applied on both sides of the lens, 3M™ Scotchgard™ Anti-fog is a long-lasting coating that provides better fog and scratch resistance when compared to traditional anti-fog coatings
- Features proprietary 3M™ Pressure Diffusion Temple Technology which helps diffuse pressure over the ear for a secure, comfortable fit
- Soft nosepiece to help reduce slippage
- Polycarbonate lens absorbs 99.9% UVA & UVB rays
- Standard(s) Met: CSA Z94.3/ANSI Z87+



### WITH FOAM GASKETS

- Optional removable foam gasket for enhanced protection from debris

### WITH BROW GUARD

- Contoured brow guard rests comfortably against forehead and helps provide additional coverage from flying particles

Model No.	Mfg. No.	Lens Tint	Lens Coating	Frame Colour	Price /Each
SDL528	SF401AF-CA	Clear	Anti-Fog/Anti-Scratch	Black & Green	5.10
SGP009	SF401SGAF-BLU	Clear	Anti-Fog/Anti-Scratch	Blue & Grey	9.75
SDL551	SF402AF-CA	Grey/Smoke	Anti-Fog/Anti-Scratch	Black & Green	5.10
SGP011	SF402SGAF-BLU	Grey/Smoke	Anti-Fog/Anti-Scratch	Blue & Grey	9.75
SDL530	SF403AF-CA	Amber	Anti-Fog/Anti-Scratch	Black & Green	5.45
SGP013	SF407SGAF-BLU	Indoor/Outdoor	Anti-Fog/Anti-Scratch	Blue & Grey	9.75
SDL529	SF410AS-CA	Indoor/Outdoor Mirror	Anti-Scratch	Black & Green	5.10

### WITH FOAM GASKET

SGP010	SF401SGAF-BLU-F	Clear	Anti-Fog/Anti-Scratch	Blue & Grey	14.00
SGP012	SF402SGAF-BLU-F	Grey/Smoke	Anti-Fog/Anti-Scratch	Blue & Grey	14.00
SGP014	SF407SGAF-BLU-F	Indoor/Outdoor	Anti-Fog/Anti-Scratch	Blue & Grey	14.00

### WITH BROW GUARD

SGP007	SF401XAF-GRN	Clear	Anti-Fog/Anti-Scratch	Black & Green	9.25
SGP002	SF401XSGAF-WHT	Clear	Anti-Fog/Anti-Scratch	Blue & White	13.05
SGP005	SF401XSGAF-BLU	Clear	Anti-Fog/Anti-Scratch	Blue & Grey	11.25
SGO999	SF403XSGAF-YEL	Clear	Anti-Fog/Anti-Scratch	Black & Yellow	11.25
SGP006	SF402XAF-GRN	Grey/Smoke	Anti-Fog/Anti-Scratch	Black & Green	9.25
SGP004	SF402XSGAF-BLU	Grey/Smoke	Anti-Fog/Anti-Scratch	Blue & Grey	11.25
SGP003	SF407XSGAF-BLU	Indoor/Outdoor	Anti-Fog/Anti-Scratch	Blue & Grey	11.25

### READERS

SGF126	SF415AF	Clear, Diopter +1.5	Anti-Fog	Black & Green	10.15
SGF127	SF420AF	Clear, Diopter +2.0	Anti-Fog	Black & Green	10.15
SGF128	SF425AF	Clear, Diopter +2.5	Anti-Fog	Black & Green	10.15



## SECUREFIT™ 600 SERIES SAFETY GLASSES

- Designed to defuse pressure over the ears, enhancing frame comfort
- Weighs less than an ounce
- Features proprietary 3M™ Pressure Diffusion Temple Technology
- Self-adjusting fit
- Polycarbonate lens absorbs 99.9% UVA and UVB rays
- Rugged anti-scratch coating helps extend lens life
- Standard(s) Met: ANSI Z87+/CSA Z94.3



SGF090



SGF091



SGF093



Model No.	Mfg. No.	Lens Tint	Lens Coating	Price /Each
SGF089	SF601SGAF	Clear	Anti-Fog	12.25
SGF090	SF602SGAF	Grey	Anti-Fog	12.25
SGF091	SF603SGAF	Amber	Anti-Fog	12.25
SGF092	SF607SGAF	Grey Indoor/Outdoor	Anti-Fog	12.25

Model No.	Mfg. No.	Lens Tint	Lens Coating	Price /Each
<b>WITH FOAM GASKET</b>				
SGF093	SF601SGAF-FM	Clear	Anti-Fog	15.45
<b>READERS</b>				
SGF099	SF615SGAF	Clear, Diopter +1.5	Anti-Fog	17.05
SGF100	SF620SGAF	Clear, Diopter +2.0	Anti-Fog	17.05
SGF101	SF625SGAF	Clear, Diopter +2.5	Anti-Fog	17.05

## SOLUS 1000 SERIES SAFETY GLASSES

- The Scotchgard™ anti-fog lens will resist fogging under most conditions, offering an unobstructed view of tasks, free from debris, withstanding up to 25 washes without losing performance
- Clear lens is ideal for indoor applications requiring impact protection
- Contemporary styling
- Removable temples enable the use of the optional strap (SFM411)
- Optional foam gasket helps reduce eye exposure (SFM410)
- Polycarbonate lenses absorb 99.9% of UVA and UVB rays
- Meets the requirements of CSA Z94.3 and ANSI Z87.1



SGF131

SFM407



Model No.	Mfg. No.	Description	Price /Each
SFM405	S1101SGAF	Clear Lens	15.15
SFM406	S1102SGAF	Grey/Smoke Lens	15.15
SFM407	S1103SGAF	Amber Lens	15.15
SGF129	S1107SGAF	Indoor/Outdoor Lens	15.15
SFM408	S1101SGAF-KT	Kit, Includes Clear Lens Eyewear, Foam Gasket and Elastic Headband	21.85
SGF130	S1102SGAF-KT	Kit, Includes Grey/Smoke lens, Foam Gasket and Elastic Headband	21.85
SGF131	S1107SGAF-KT	Kit, Includes Indoor/Outdoor lens, Foam Gasket and Elastic Headband	21.85
SFM410	SOLUS-FOAM	Replacement Foam Gasket	4.90
SFM411	SOLUS-STRAP	Replacement Strap	3.20

## VIRTUA™ CCS SAFETY GLASSES

- Comfortable, lightweight frame features the Cord Control System (CCS) with an optional foam gasket attachment
- CCS is designed to keep a corded earplug attached, untangled, and ready for use
- Foam gasket helps limit eye exposure to nuisance dust while providing additional cushioning
- Anti-fog polycarbonate lens absorb 99.9% UV
- Certification(s): Meets the requirements of CSA Z94.3-07 and is Impact Rated to ANSI Z87.1-2010



SEH157

SDN363



Model No.	Mfg. No.	Lens Tint	Price /Each
SEH156	11872-00000-20	Clear	13.85
SEH157	11873-00000-20	Grey	13.85
SEH158	11874-00000-20	I/O Mirror	13.85
SDN363	VC215AF	Clear, Diopter +1.5	28.30
SDN364	VC220AF	Clear, Diopter +2.0	28.30
SDN365	VC225AF	Clear, Diopter +2.5	28.30



## BX™ SAFETY GLASSES

- High impact resistant polycarbonate lens provides 99.9% UV protection
- Soft, universal-fit nose bridge
- Three lens angles for custom fit
- Adjustable temple lengths
- Soft tip temples feel good even after extended wear
- Certified to CSA standard Z94.3



Model No.	Mfg. No.	Lens Tint	Price /Each
SA0648	11380-00000-20	Clear	9.20
SA0649	11381-00000-20	Grey	10.75

## BX™ W/READER LENS SAFETY GLASSES

- Anti-fog, reader lenses + 1.5, + 2.0, + 2.5
- Universal-fit nose bridge
- Sliding temple lengths with soft tips for comfort even after extended wear
- High impact polycarbonate lenses with 99.9% UV protection
- Silver/black frame
- Certified to CSA standard Z94.3
- Meets ANSI standard Z87.1



Model No.	Mfg. No.	Lens Tint	Diopter	Price /Each
SAN521	11374	Clear	+ 1.5	22.85
SAN522	11375	Clear	+ 2.0	21.45
SAN523	11376	Clear	+ 2.5	22.85
SAN524	11377	Grey	+ 1.5	22.85
SAN525	11378	Grey	+ 2.0	22.85
SAN526	11379	Grey	+ 2.5	22.85

## PRIVO™ SAFETY GLASSES

- Euro-styled safety eyewear: look good while being safe!
- Excellent coverage and world-class fit
- Soft-tipped temples
- Soft comfort nose bridge
- Certified to CSA standard Z94.3



Model No.	Mfg. No.	Frame Colour	Accent Colour	Lens Tint	Price /Each
SAP456	12261	Black	Orange	Clear AF	11.25
SAP457	12262	Black	Orange	Grey AF	11.25
SAP458	12263	Black	Orange	Amber AF	11.25
SAP459	12264	Black	Orange	I/O Mirror	11.25

## OX™ 2000 SAFETY GLASSES

- Sturdy, durable OX protective eyewear delivers high impact protection
- Wrap-around side shields and flexible, polycarbonate construction with over-the-glass coverage
- Its lightweight frame and anti-fog hard coat lens deliver clarity
- Meets the requirements of CSA Z94.3-2007 and the High Impact Requirements of ANSI Z87.1-2003



Model No.	Mfg. No.	Lens Tint	Lens Coating	Price /Each
SDL985	12166-00000-20	Clear	Anti-Fog	5.00

## SECUREFIT™ 500 SERIES SAFETY GLASSES

- 3M's innovative temple design features slotted ribs that help provide comfortable pressure equalization, allowing the temples to flex and self-adjust to the size of the wearer's head
- Curved temples apply pressure to the less sensitive back of the head, instead of the temples, helping achieve a comfortable fit even during rapid head movement
- Sporty design with contemporary lens shape and a sleek profile
- Adjustable ratchet temples allow user to adjust the lens for facial features and eyeglass position
- U6 rated polycarbonate lenses absorb 99.9% of UVA, UVB, and UVC rays between 200 nm and 380 nm
- Foam gasket
- Standard(s) Met: CSA Z94.3, ANSI Z87+
- Lens Coating: Anti-Fog/Anti-Scratch
- UV Protection: 0.999

Model No.	Mfg. No.	Lens Tint	Temple Colour	Price /Each
SHB201	SF501SGAF-BLK-FM	Clear	Black	14.00
SHB202	SF501SGAF-BLK	Clear	Black	11.25
SHB203	SF502SGAF-BLK	Grey	Black	11.25
SHB204	SF503SGAF-BLK	Amber	Black	11.25
SHB205	SF507SGAF-BLK	Indoor/Outdoor, Grey	Black	11.25
SHB206	SF507SGAF-BLK-FM	Indoor/Outdoor, Grey	Black	14.00
SHB208	SF502GAF-BLK-FM	Grey	Black	14.00
SHB209	SF517AF-GRN	IR 1.7	Green & Black	15.95
SHB207	SF500-FOAM	Replacement Foam Gasket, Pk. of 10		95.00



# SAFETY EYEWEAR

## ZORGE G2 SAFETY GLASSES

- Features a thermoplastic rubber (TPR) adjustable nosepiece
- Wraparound frame for improved peripheral vision and protection
- Frame constructed of flexible, durable nylon composite
- Lenses block 99.9% of UVA/UVB/UVC rays
- Standard(s) Met: CSA Z94.3, ANSI Z87+, MCEPS GL-PD 10-12



SHC390



Model No.	Mfg. No.	Lens Tint	Price /Each
SHC390	DZ111-G2	Clear	8.16
SHC391	DZ116-G2	Smoke	8.16
SHC392	DZ117-G2	Silver Mirror	8.16

## ROBSON SAFETY GLASSES

- Flexible and durable black frame
- Soft TPR nose pads and temple tips for comfort
- Vapor Shield "military grade" anti-fog lenses are completely resistant to fog
- Lenses block 99.9% of UVA/UVB/ UVC rays
- CSA Z94.3 and Military Ballistic MCEPS GL-PD 10-12 compliant



SEG818



Model No.	Mfg. No.	Lens Tint	Type	Price /Each
SEG815	XR411VS	Clear	Without Gasket	31.80
SEG816	XR416VS	Smoke	Without Gasket	31.80
SEG817	XR411VSG	Clear	Gasket included	35.40
SEG818	XR416VSG	Smoke	Gasket included	35.40

## NEVOSA SAFETY GLASSES

- 85% of light passes through the lenses
- Lenses block 99.9% of UVE/UVB/UVC rays
- Features soft temple tips for comfort
- Standard(s) Met: CSA Z94.3
- Frame Colour: Black



SGQ624



Model No.	Mfg. No.	Lens Tint	Lens Coating	Price /Each
SGQ427	XV411AR	Clear	Anti-Reflective	6.34
SGQ624	XV413	Light Blue	Anti-Scratch	6.34
SGQ625	XV416	Smoke	Anti-Scratch	6.34

## PRISM SAFETY GLASSES

- Ultra-sporty design with its ultra-flexible, co-injected and customisable temples
- Sporty design
- Comfortable, straight temples
- Anti-scratch high performance
- Anti-fog high performance
- Standard(s) Met: CSA Z94.3

SEO780



Model No.	Mfg. No.	Lens Tint	Price /Each
SEO779	PRIPSI	Clear	12.70
SEO780	PRIPSF	Grey/Smoke	14.30

## RUSH+ SAFETY GLASSES

- Ultra-sporty design with its ultra-flexible, co-injected and customisable temples
- Non-slip bridge
- Anti-fog PLATINUM\*
- Co-injected ultra-flexible temples
- Two-coloured temples
- Anti-scratch high performance
- Standard(s) Met: CSA Z94.3

SEO787



Model No.	Mfg. No.	Lens Tint	Price /Each
SEO787	RUSHPTWI	Brown	21.80
SEO786	RUSHPPSF	Grey/Smoke	21.80
SEN444	RUSHPSI	Clear	19.50

## RUSH SAFETY GLASSES

- Ultra-sporty design with its ultra-flexible, co-injected and customisable temples
- The comfort of panoramic vision
- Adjustable non-slip bridge
- Non-slip temples
- Anti-scratch high performance
- Anti-fog high performance
- Standard(s) Met: CSA Z94.3

SEO781



Model No.	Mfg. No.	Lens Tint	Frame Colour	Price /Each
SEO782	RUSHPSF	Grey/Smoke	Black	13.30
SEO781	RUSHPSI	Clear	Crystal	11.70

## TRACKER SAFETY GLASSES

- Removable foam reinforcement with indirect ventilation
- Removable adjustable strap
- Side ventilation
- Anti-scratch high performance
- Anti-fog PLATINUM\*
- Standard(s) Met: CSA Z94.3

SEO791



Model No.	Mfg. No.	Lens Tint	Price /Each
SEO791	TRACPSF	Grey/Smoke	35.80
SEO790	TRACPSI	Clear	34.00

## SAFETY GLASSES

- The safety glasses feature comfortable temple arms designed for extended wear
- These protective glasses have an integrated flexible nose bridge, providing you with extended comfort
- Polybag packaging
- Standard(s) Met: CSA Z94.3, ANSI Z87+



SHA112



Model No.	Mfg. No.	Lens Tint	Lens Coating	Price /Each
SHA112	48-73-2011	Clear	Anti-Scratch	7.99
SHA116	48-73-2016	Smoke	Anti-Scratch	7.99
SHA125	48-73-2101	Yellow	Anti-Scratch	7.99
SHA129	48-73-2106	Grey	Anti-Scratch	7.99
SHA114	48-73-2013	Clear	Anti-Fog/Anti-Scratch	14.50
SHA118	48-73-2018	Smoke	Anti-Fog/Anti-Scratch	14.50
SHA127	48-73-2103	Yellow	Anti-Fog/Anti-Scratch	14.50
SHA131	48-73-2108	Grey	Anti-Fog/Anti-Scratch	14.50

## HAWK SERIES SAFETY GLASSES

- Beautiful, base 9 Lens
- Flexi-Fit adjustable nose bridge system
- Dual-shot temples
- DynaShield coating
- Standard(s) Met: ANSI Z87+, CSA Z94.3
- Frame Color: Red/Black

SFZ472



Model No.	Mfg. No.	Lens Tint	Lens Coating	Price /Each
SFZ472	EP825C	Clear	Anti-Fog	12.20
SFZ499	EP825IO	Indoor/Outdoor Mirror	Anti-Fog	13.70
SFZ525	EP825S	Smoke	Anti-Fog	13.20

## GOGGLE GEAR SPLASH SAFETY GOGGLES

- 3M™ Goggle Gear 500 Series Protective Eyewear are a low profile splash goggle featuring Scotchgard™ clear anti-fog lens coating which helps keep lenses clear - providing longer lasting fog resistance than traditional anti-fog coatings
- Additionally, the Scotchgard™ anti-fog coating retains its anti-fog effectiveness through at least 25 washings with water
- Low-profile design with removable strap
- Lens, frame, and strap can be quickly disassembled for cleaning
- Indirect venting
- Polycarbonate lenses absorb 99.9% of UVA and UVB rays
- Meets the requirements of CSA Z94.3 and ANSI Z87.1
- Lens Tint: Clear
- Lens Coating: Anti-Fog

Model No. SFM409  
Mfg. No. GGS01SGAF  
Price/Each \$31.70



## ADAPT SAFETY GLASSES

- The toric lens shape in ADAPT glasses gives extra space for the eyewear to fit with respirators
- The bottom rims in ADAPT glasses were shortened, giving extra space on the nose for secure-fitting masks
- Anti-fog coating keeps vision clear with or without a mask
- Soft flexible flange helps protect against flying particles
- Toric lens shape for a closer fit
- Reduced lens dimensions for added space in the nose bridge area, allowing for a comfortable fit with a respirator
- UV filter and high anti-scratch coatings
- Flexible soft grip temples
- Ultra-light construction
- Overmold
- 100% PVC-free for a reduced environmental impact
- Standard(s) Met: CSA Z94.3, ANSI Z87+
- Anti-Fog Coating: Two Sided NK-100

SHH509



SHH511



Model No.	Mfg. No.	Lens Tint	Price /Each
SHH507	5002A-1	Amber	18.90
SHH508	5002S-1	Smoke	18.70
SHH509	5002C-1	Clear	19.90
SHH511	5002M-1	Indoor/Outdoor	21.70

## OTG EXTRA SERIES SAFETY GLASSES

- Extra-large sized lens to fit over the largest prescription spectacles
- Extra soft nose piece that will accommodate all kinds of nose configurations
- Adjustable temples give you the possibility to adjust the lens up and down for better vision
- New, unique, highly-comfortable EZ-ON temple system
- Standard(s) Met: ANSI Z87+, CSA Z94.3
- Temple Color: Black



SFZ480



Model No.	Mfg. No.	Lens Tint	Lens Coating	Price /Each
SFZ480	EP750C	Clear	Anti-Fog/Anti-Scratch	11.20
SFZ522	EP750IO	Indoor/Outdoor Mirror	Anti-Fog/Anti-Scratch	12.70
SFZ416	EP750A	Amber	Anti-Fog/Anti-Scratch	12.00
SFZ533	EP750S	Smoke	Anti-Fog/Anti-Scratch	12.00

## CENTURION™ SAFETY IMPACT SAFETY GOGGLES

- Wide-angle wraparound lens and frame for good peripheral vision
- Accommodates prescription eyewear
- Standard(s) Met: CSA Z94.3/ANSI Z87+
- Lens Tint: Clear

SGC402



Model No.	Mfg. No.	Ventilation Type	Headband	Lens Coating	Price /Each
SGC400	40301-0000-10	Direct	Elastic	Anti-Fog	13.00
SGC402	40305-0000-10	Indirect	Neoprene	Anti-Fog	14.00



# SAFETY EYEWEAR

## CARBONVISION™ SAFETY GOGGLES

- Flexible soft frame adapts perfectly to the face to ensure a perfect fit and seal around the eyes for high-performance protection and all-day comfort
- The soft, flexible body is permanently fixed to the frame, making it easy to clean and maintain
- Convenient clip makes it easy to remove headband before cleaning
- Ideal for protection from impact, dust/airborne particles as well as chemical splash hazards
- Low profile, compact design is ideal for wearing with disposable respirators and protective caps
- Dura-streme® dual anti-fog/anti-scratch coating
- Standard(S) Met: CSA Z94.3/ANSI Z87+



**Honeywell**  
UVEX

Model No.	Mfg. No.	Lens Tint	Headband	Price /Each
SEH176	S1650D	Clear	Neoprene	23.20

## FLEX SEAL SAFETY GOGGLES

- Lightweight, silicone body conforms to assure the highest level of comfort and eye protection
- Cured silicone body stays soft and supple in extreme temperatures
- Provides exceptional chemical splash and impact resistance
- Low profile and optically correct polycarbonate lens provides full field of vision
- HydroShield® anti-fog coating and indirect venting system minimize fogging
- Fits over most prescription eyewear
- Easy and economical lens replacement system
- Pivoting clips permit the wearer to position the goggle on a hard hat or position the headband above the ears
- Meets ANSI Z87+ (High Impact) and tested by Honeywell to meet the requirements of the CSA Z94.3 standard
- Frame Colour: Navy Blue
- Lens Tint: Clear
- Standard(s) Met: ANSI Z87+



**Honeywell**  
UVEX

Model No.	Mfg. No.	Ventilation Type	Headband	Lens Coating	Price /Each
SGS406	S3400HS	Indirect	Fabric/Neoprene	Anti-Fog	24.50

## V-MAXX® SAFETY GOGGLES

- Sleek wrap-around styling
- Direct vent for impact resistance and indirect vent for chemical splash applications
- Peel-off goggle covers available to extend useful life of the lens
- OTG compatible
- 180° clear field of vision
- Lenses coated with Fog-ban® anti-fog coating
- Pivoting headband clips to adjust strap around hardhats or hearing protection
- Adjustable elastic or neoprene headband
- Certified to CSA standard Z94.3
- Standard(S) Met: CSA Z94.3/ANSI Z87+



**Honeywell**  
UVEX

Model No.	Mfg. No.	Description	Lens Tint	Price /Each
SAI905	11250800	Direct vent, red elastic headband	Clear Fog-ban®	9.78
SAI906	11250810	Indirect vent, black neoprene headband	Clear Fog-ban®	11.60
SAI908	11250850	Indirect vent, black frame and elastic headband	Shade 5.0	26.40

## Z2300 SAFETY GOGGLES W/SAFETY SHIELD

- Indirect ventilation and a polycarbonate shield for full face protection
- Face shield detaches from the goggles
- Curved face shield conforms to the shape of the users face for added protection
- Can be used over most prescription eyewear
- Compliant with CSA standard Z94.3

Model No. SEL095  
Price/Each \$15.10

**ZENITH®**  
Safety Products



## Z300 SAFETY GOGGLES

- Impact proof polycarbonate lens with UV protection
- Adjustable elastic headband
- Indirect ventilation on models SEF219 and SAN430 protects against dust, fumes and chemical splash
- Distortion-free
- Compliant with CSA standard Z94.3



SEF219

Model No.	Description	Price /Each
SEF218	Direct Vent	2.99
SEF219	Indirect Vent	3.85
SAN430	Indirect Vent Anti-fog	5.45

**ZENITH®**  
Safety Products

## Z1100 SAFETY GOGGLES

- Wrap-around style provides excellent 180° panoramic vision
- Extremely flexible soft PVC goggle body for greater comfort
- Impact resistant polycarbonate lens
- Antifog lens is ideal for high humidity applications
- Indirect vent increases air flow and protects against dust, fumes and chemical splash
- Adjustable elastic headband
- Compliant with CSA standard Z94.3



SEK294

SGR809

**ZENITH®**  
Safety Products

Model No.	Lens Tint	Price /Each
SEK294	Clear	8.85
SGR808	3.0	15.25
SGR809	5.0	18.15

## EYEWEAR CASE

- Extends the life of eyewear by protecting the lens from scratches and abrasions
- Zipper closure
- Accommodates all Zenith eyewear
- Attached belt clip offers multiple attachment options
- Colour: Black

Model No. SEF180  
Price/Each \$6.60



## GOGGLES CASE

- Extends the life of goggles by protecting the lens from scratches and abrasions
- Zipper closure
- Accommodates all Zenith goggles
- Attached belt clip offers multiple attachment options
- Colour: Black

Model No. SEF181  
Price/Each \$6.95



## NEOPRENE EYEWEAR RETAINER

- Lightweight and durable
- Fits a wide range of eyewear
- Colour: Black

Model No. SEF183  
Price/Each \$1.30



## NYLON EYEWEAR RETAINER

- Tetoron construction
- Fits a wide range of eyewear
- Colour: Black

Model No. SEF182  
Price/Each \$1.90



## SKULLERZ® COTTON EYEWEAR LANYARDS

- 100% cotton
- Adjustable barrel slide
- Durable, cool, comfortable
- Machine washable
- Fits standard frames
- Colour: Black



SAK847



SAK848



### 3200 SERIES

Model No. SAK847  
Mfg. No. 19152  
Price/Each \$5.73

### 3215 SERIES DUAL BREAKAWAY DESIGN

Model No. SAK848  
Mfg. No. 19212  
Price/Each \$7.17

## SKULLERZ® BREAKAWAY ROPE EYEWEAR LANYARD

- 3 mm nylon rope construction
- Breakaway connection
- Slip-style attachment fits a variety of temple sizes
- Colour: Black

Model No. SDM707  
Mfg. No. 19324  
Price/Each \$2.92



## SKULLERZ® ELASTIC COIL EYEWEAR LANYARD

- Stretchable nylon/elastic construction
- Low-profile design
- Slip-style attachment fits a variety of temple sizes
- Colour: Black

Model No. SDM708  
Mfg. No. 19280  
Price/Each \$6.14



## SAFETY GLASSES DISPENSER WITH LID

- Compact unit designed to hold up to six pairs of glasses
- Dust cover to isolate glasses
- Wall or table mount
- 9" W x 6" D x 3" H

Model No. SED048  
Mfg. No. PD211L-F  
Price/Each \$116.99



## DELUXE VISITOR SPEC DISPENSER

- Bottom door that keeps glasses in and folds down for easy dispensing
- Supplied with two top holes making them ideal for wall-mounting
- Holds approximately 20-25 glasses
- 8" W x 4" D x 18" H

Model No. SED050  
Mfg. No. MVSD  
Price/Each \$119.99



# SAFETY EYEWEAR

## DISPOSABLE LENS CLEANING STATIONS

- SEE380 contains 600 interfolded 5" x 8" tissues and one 237 ml bottle of fluid
- SEE382 contains 1200 interfolded 5" x 8" tissues and one 473 ml bottle of fluid



Model No.	Description	Price/Each
SEE380	One 237 ml/8 oz. bottle w/pump and 600 tissues	14.45
SEE382	One 473 ml/16 oz. bottle w/pump and 1200 tissues	22.50

## DISPOSABLE PREMIUM LENS CLEANING STATIONS

- Supreme anti-fog, anti-static, low alcohol, silicone-free, fast-drying lens cleaning solution
- Safe for all types of glass, plastic or polycarbonate eyeglasses, safety glasses, goggles, face shields and computer monitors



Model No.	Size			Description	Price/Each
	L"	D"	H"		
SGR041	8	x 4	x 8	One 237 ml/8 oz. bottle w/pump and 600 tissues	16.60
SGR042	8	x 5	x 12-1/2	One 473 ml/16 oz. bottle w/pump and 1200 tissues	25.65

## LENS CLEANING TOWELETTES

- Excellent cleaning with no streaking
- 5" x 8" individually wrapped towelettes permeated with anti-fog, anti-static formula
- 100 towelettes per dispenser
- Contains Isopropanol

Model No. SEE379  
Price/Each \$10.30



## LENS CLEANER

- Anti-fog, anti-static lens cleaning solution
- Safe for all types of glass, plastic or polycarbonate eyeglasses, safety glasses, goggles, faceshields and computer monitors
- Silicone free

SEE378

SEE381

SEE377



Model No.	Size	Description	Price/Each
SEE377	237 ml/8 oz.	Modern round bottle w/pump	4.95
SEE378	473 ml/16 oz.	Boston round bottle w/pump	5.40
SEE381	3.78 L/1 gallon	Refill	24.45

## ANTI-FOG PREMIUM LENS CLEANER

- Supreme anti-fog, anti-static, low alcohol, silicone-free, fast-drying lens cleaning solution

SGR040

SGR038

SGR039



Model No.	Size	Description	Price/Each
SGR038	237 ml	Modern round bottle w/pump	5.65
SGR039	473 ml	Boston round bottle w/pump	6.20
SGR040	3.78 L	Refill	28.10

## LENS CLEANING TISSUES

- For general lens cleaning and wiping needs
- Fits all Zenith lens cleaning stations
- 300 interfolded 5" x 8" wipes
- Box includes openings on either side; can be placed vertically or horizontally

Model No. SEE398  
Price/Each \$3.10



## RESPIRATORS & PPE CLEANING TOWELETTES

- For rubber or latex face and mouth pieces, respirators, etc.
- Alcohol-free
- Avoids "drying-out" associated with alcohol based cleaners
- 5" x 8" individually wrapped towelettes
- 100 towelettes per dispenser

Model No. SEE383  
Price/Each \$14.15





## HIGH PERFORMANCE® FACE SHIELDS

- Exclusive overlay designs; heat and scratch resistant
- Oversized 7" heat resistant crown for extra protection
- Lifetime limited warranty
- Meets ANSI Z87.1 and CSA Z94.3 standards

Headgear and face shields sold separately



**Honeywell**  
FIBRE-METAL®

Model No.	Mfg. No.	Description	Price /Each
SHB580	F500-HS	Headgear	51.90
SAP369	4199CL	Clear, 19" x 9 3/4"	22.20
SAR046	4199IRUV3	IR 3.0, 19" x 9 3/4"	52.60

## HIGH PERFORMANCE® FACE SHIELDS

- High performance face shields are stronger, more durable and more heat-resistant than ordinary face shields
- Made from Noryl®, the same material used in Fibre-Metal®'s welding helmets
- Exclusive channel grip system mounts windows and locks them in place to form a perfect seal from dust, dirt and debris
- Deeper 4" crown protector extends protection without increasing weight
- Wide vision 8" x 17" wraparound visors provide 40% more protection area than standard size face shields
- Visors are 0.060" thick for an extra margin of protection

Headgear and face shield sold separately



**Honeywell**  
FIBRE-METAL®

Model No.	Mfg. No.	Description	Price /Each
SAM376	F-400	Headgear	56.90
SAM377	4178	Clear face shield	14.80
SAM403	4178IR/UV5	IR/UV5 Shade 5.0 face shield	40.30

## FORESTRY KITS

CONTAINS:

- 1 SFM519 hard hat, orange
- 1 SAM365 forestry screen
- 1 SAH731 Intruder muff, NRR 27 dB



**Honeywell**  
NORTH

Model No.	Mfg. No.	Dimensions			Price /Each
		W"	x	H"	
SDM247	SDM247-KIT	15-1/2	x	12	94.00

## TURBOSHIELD FACE SHIELDS

- Features hardcoat/anti-fog polycarbonate
- Protection from debris impact and chemical splash, must be used in conjunction with primary eye protection
- Provides superior comfort for longer wear, the easiest visor exchange available, and optimal balance when used with a hard hat
- Perfect for workers exposed to falling or flying objects, impact, splash, and airborne debris; it can also be comfortably worn with most goggles, respirators and earmuffs
- Provides superior comfort for longer wear, the easiest visor exchange available, and optimal balance when used with a hard hat
- Standard(s) Met: CSA Z94.3/ANSI Z87+

Headgear and face shield sold separately



**Honeywell**  
UVEX®

Model No.	Mfg. No.	Description	Price /Each
SEJ800	S9500	FaceShield Headgear Bracket, Ratchet	43.70
SEJ801	S9510	Face Shield Hard Hat Adaptor	42.00
SEJ802	S9555	Face Shield, Clear, 12-1/2" x 8-1/2", Hardcoat/Anti-fog	54.60

## BIONIC™ SHIELDS

- Lightweight and balanced, ergonomic design for extended use
- Extended chin and top-of-head protection
- Enhanced protection from airborne debris
- Excellent optics and increased visibility
- Easy-to-set ratcheting headgear locking mechanism assures comfortable, secure fit
- Highly adjustable headgear tilts visor nearer or farther from face depending on preference and application
- Easily replaceable visor with dual position choices
- Comfortable cell foam on back of headgear
- Breathable, removable, washable headband
- Comfortably worn with most goggles and respirators
- Meets ANSI standard Z87.1-2010 and is certified to the requirements of CSA standard Z94.3



**Honeywell**  
UVEX®

Model No.	Mfg. No.	Description	Price /Each
<b>BIONIC™ SHIELDS</b>			
SAK422	S8510	Clear anti-fog hardcoat face shield	61.90
<b>REPLACEMENT FACE SHIELDS</b>			
SAK424	S8555	Clear anti-fog hardcoat	31.90
SAK425	S8560	Shade 3.0, uncoated	40.70
SAK426	S8565	Shade 5.0, uncoated	46.80
<b>ACCESSORIES</b>			
SA0775	S8570	Hard hat adapter	36.30
SA0776	S8595	Ratchet suspension	20.00

# FACE PROTECTION

## PROTECTO-SHIELD® PROLOK® FACE SHIELDS

- Impact and splash protection
- Constructed of tough thermoplastic
- Heat resistant brow guard
- Easy sizing and tension adjustment for individual visor positioning
- Face Shields easily attach with no snaps, posts or levers
- Specially designed with a chemical splash drip edge to prevent fluids from splashing down inside the visor

### FACE SHIELDS

- Universal hole pattern allows visors to be used with their popular manufacturers' headgear
- Easy attachment without snaps, posts or levers
- Reinforced edge to resist cracking from abuse
- Popular industry sizes and thicknesses
- Aluminum-bound acetate visors form easily for a contoured, customized fit
- Face Shields offer secondary protection and must be worn with spectacles or goggles
- Meets ANSI Z87.1-2010 and is certified to the requirements of the CSA Z84.3



**Honeywell**  
NORTH

Model No.	Mfg. No.	Description	Price /Each
<b>HEADGEARS</b>			
SG413	11380048	Ratchet Adjustment	25.20

Model No.	Mfg. No.	Description	Dimensions H" x W" x D"	Price /Each
<b>FACESHIELDS - MOLDED</b>				
SG418	11390044	Clear, Triton	8-1/2 x 15 x 0.060	10.40
SG419	11390047	Clear, Polycarbonate	8-1/2 x 15 x 0.060	14.30

## QUAD 500™ PREMIUM ANTI-FOG MULTI-PURPOSE FACE SHIELDS

- Extra-large window provides superior panoramic view
- Premium Sta-Clear anti-fog coating guarantees a fog free working environment
- Integrated side and chin guard protect against splash and flying debris
- Extra-large crown provides added top of head protection
- Features exclusive 370 Speed Dial ratcheting headgear
- Windows are built with detents that lock in the up or down position until manually adjusted
- Designed to be used with safety glasses, respirators, and most goggles
- Ideal for heavy duty grinding, plasma cutting, brazing, and much more
- 12-1/8" W x 9" H x 0.06" T
- Standard(s) Met: ANSI Z87+



SHA392

**JACKSON**  
SAFETY EQUIPMENT

Model No.	Mfg. No.	Description	Price /Each
SHA390	14220	Headgear with Face Shield	108.00
SHA392	14230	Headgear with Clear Face Shield and Shade 5.0 Flip Visor	146.00
SHA393	14233	Headgear with Clear Face Shield and Shade 8.0 Flip Visor	149.00
SHA395	14250	Replacement Clear Face Shield	46.40
SHA396	14255	Replacement Shade 5.0 Flip Visor	63.40
SHA397	14258	Replacement Shade 8.0 Flip Visor	63.40
SHA407	20694	Speed Dial 370 Suspension Replacement	34.80

## F4XP PREMIUM FACE SHIELDS

- Exclusive quick-change install and removal system ensures fast and efficient window changes
- Extended crown is built with premium high-impact rated material for optimum coverage and safety
- Features exclusive 370 Speed Dial ratcheting headgear
- Crown can be used with all universal pin pattern windows including over 40 Jackson Safety styles
- Suspension Type: Ratchet



SHA399

SHA408

138-1074

**JACKSON**  
SAFETY EQUIPMENT

Model No.	Mfg. No.	Description	Price /Each
SG413	11380048	Headgear	25.20
SHA399	14262	Headgear with Face Shield	55.10
SHA408	20695	Speed Dial 370 Suspension Replacement	34.80
SHA412	29087	F20 Clear Moulded Face Shield, 8" x 15-1/2" x 0.06"	20.30
SEE768	30706	F20 Clear Flat Face Shield, 8" x 15-1/2" x 0.04"	7.99
138-1074	29080	F50 5.0 Tint Moulded Face Shield, 8" x 15-1/2" x 0.06"	41.50

## MAXVIEW™ PREMIUM FACE SHIELDS

- Extra-large polycarbonate window for superior optics and panoramic view
- Integrated side and chin guard protect against splash and flying debris
- Extended top of head coverage protects against hazards from above
- Lightweight construction for optimum comfort even during extended use
- Features exclusive 370 Speed Dial ratcheting headgear
- Designed to be worn with safety glasses and fits well with respirators and most goggles
- 13-1/3" W x 9" H x 0.04" T
- Material: Polycarbonate
- Standard(s) Met: ANSI Z87+



SHA386

SHA408

SAS087

**JACKSON**  
SAFETY EQUIPMENT

Model No.	Mfg. No.	Description	Price /Each
SHA386	14200	Headgear with Face Shield	54.40
SHA387	14201	Headgear with Anti-Fog Face Shield	85.80
SHA388	14214	Replacement Face Shield	18.50
SHA389	14215	Replacement Anti-Fog Face Shield	43.40
SHA408	20695	Speed Dial 370 Suspension Replacement	34.80
SAS087	32187	Replacement Sweatbands, 2/pkg.	2.97

## RATCHET HEADGEAR WITH POLYCARBONATE FACE SHIELD

- Combination headgear and faceshield safety system
- Includes H8A ratchet headgear and WP96 polycarbonate faceshield with adjustable ratchet suspension
- Molded faceshield provides impact protection
- Five position crown strap
- Shield tint: Clear
- Certification(s): Meets the requirements of ANSI Z87.1-2003



SDA135



Model No.	Mfg. No.	Description	Dimensions H" x W" x D"	Price /Each
SDA135	82783-00000	Headgear w/WP96 Face shields	9 x 14.5 x 0.08	45.40
SM817	82701-00000	Replacement WP96 Face shields	9 x 14.5 x 0.08	11.00

## FACE SHIELDS

Choose from a wide variety of faceshields that fit easily on MSA faceshield frames. Nitrometer faceshields and chin-guards incorporate an additional guard to help protect chin and neck and reduce the chance of upsweep of particles and splash. Face shields should always be worn with primary eye protection such as high impact resistant spectacle or goggles. All MSA faceshields meet or exceed applicable requirements of ANSI Z87.1.



SGU726

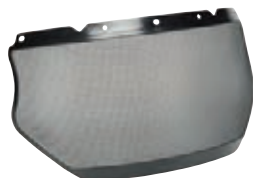

SEL099



SEL098



Model No.	Mfg. No.	Description	Window Dimensions W" x D"	Price /Each
<b>POLYCARBONATE</b>				
SEK030	10115836	Clear, Side Contour	8 x 17	8.31
SEL088	10115842	Green Tint, Molded, AF/AS	8 x 17	28.30
SEL098	10115853	Clear, Molded	10.375 x 17	41.50
<b>PROPIONATE</b>				
SEL084	10115855	Clear, Molded	8 x 17	23.20
SEL085	10115851	Clear, Molded	9.25 x 18	26.20
<b>MESH</b>				
SEL099	10116557	Mesh w/Plastic Edge	-	14.80
SEL013	10158822	V-Gard, Epoxy-Coated Steel Mesh	-	27.70
<b>ARC FLASH</b>				
SEL107	10115847	Molded, Rated 12.9 Cal/cm <sup>2</sup>	29.25 x 18	142.00
SEL108	10118480	Molded, Nitrometer, Chin Protector	8 x 7.25	149.00
<b>FRAME</b>				
SEJ998	10115730	V-Gard, for Slotted Caps, w/Debris Control		19.60
SEL103	10121266	V-Gard, for Slotted Caps		14.20
SEL104	10115821	V-Gard, for Slotted Caps, High Temp, w/Debris Control		30.40
SEL105	10121267	V-Gard, for Slotted Caps, High Temp, w/o Debris Control		25.30
SEL106	10116552	V-Gard, Universal Frame, High Temp, w/Debris Control		30.40
SGU726	10187161	V-Gard, Universal Accessory Cap Frame		31.00
SGV411	10158799	V-Gard, Universal Metal Frame Replacement for Caps		22.00
SGU462	10187162	V-Gard, Universal Cap Frame, w/o Debris Control		27.70

## GOGGLES WITH SAFETY SHIELD

- Indirect ventilation and a polycarbonate shield for full face protection
- Face shield detaches from the goggles
- Curved face shield conforms to the shape of the users face for added protection
- Can be used over most prescription eyewear
- Compliant with CSA standard Z94.3

Model No. SEL095  
Price/Each \$15.10



## V-GARD® ARC ACCESSORY KIT

- **Kit contains:**
  - White V-Gard® Cap with ratchet suspension
  - V-Gard® Frame for Slotted Caps
  - V-Gard® Arc Nitrometer with V-Gard® Standard Chin Protector
- Rated to 11.3 cal/cm<sup>2</sup> when tested to ASTM F2178-2008 (ref. NFPA 70E-2012, Hazard Risk Category 2); Must be assembled by user prior to wearing to secure stated calorie rating

Model No. SEL101  
Mfg. No. 10118696  
Price/Each \$189.00



## V-GARD® ACCESSORY SYSTEM KIT WITH V-GARD® CAP

- **Kit contains:**
  - White V-Gard® Cap with ratchet suspension
  - V-Gard® Frame for Slotted Caps with debris control
  - V-Gard® Clear, Polycarbonate Visor, 8" x 17" x 0.04"

Model No. SEL109  
Mfg. No. 10118695  
Price/Each \$57.10



## DISPOSABLE FACE SHIELD WITH HEAD GEAR

- Distortion free face shield offers protection against splashes
- Free of latex and fibreglass
- Anti-fog, anti-static and dust-proof
- Not for industrial use
- Headpiece is held in place by an elastic and equipped with a foam strip for comfort
- Lightweight
- Material: PET
- Height x Width: 8-5/8" x 12-1/2"
- Thickness: 0.01"

Model No. SGU285  
Price/Each \$1.29





# HARDHATS

## WHISTLER HARD HAT - TYPE 1

- Sleek & modern style
- Lightweight high density polyethylene
- Rain trough & slotted design shell to accommodate all the latest accessories such as hearing protection, face shields, forestry kits or welding protection
- Attachment points for chin straps
- Comfortable 4-point nylon webbing suspension
- Large printing surfaces for company logo's on front, sides & back
- Certification(s): ANSI Type I/CSA Type 1

SFY607



Model No.	Mfg. No.	Colour	Price /Each
<b>"SURE-LOCK" RATCHET</b>			
SFY466	HP241/01	White	14.00
SFY580	HP241/02	Yellow	14.00
SFY570	HP241/07	Sky Blue	14.00
SFY540	HP241/08	Navy Blue	14.00
<b>"SURE-LOCK" RATCHET</b>			
SFY722	HP241R/01	White	16.60
SFY730	HP241R/02	Yellow	16.60
SFY685	HP241R/03	Orange	16.60
SFY712	HP241R/07	Sky Blue	16.60
SFY678	HP241R/08	Navy Blue	16.60
SFY607	HP241R/11	Black	16.60
SFY698	HP241R/15	Red	16.60
SFY657	HP241R/31	High Visibility Orange	16.60
SFY651	HP241R/44	High Visibility Yellow	16.60

## STROMBOLI HARD HAT - TYPE 1

- Safety helmet designed primarily for welders and high heat applications
- Shell is made of lightweight polycarbonate offering exceptional protection against heat, radiation and impacts
- The rain trough free shell is narrower than other models and allows the addition of all types of welding helmets available on the market without any restrictions
- Attachment points for chin straps
- "Sure-Lock" ratchet adjustment to properly fit all head sizes large or small
- Large printing surfaces for company logo's on front, sides & back
- Certification(s): ANSI Type I/CSA Type 1

SFY749



Model No.	Mfg. No.	Colour	Price /Each
<b>"SURE-LOCK" RATCHET</b>			
SFY748	HP841R/01	White	43.90
SFY749	HP841R/02	Yellow	43.90
SFY740	HP841R/11	Black	43.90
SFY746	HP841R/15	Red	43.90
SFY747	HP841R/71	Steel Blue	43.90
SFY447	HP841RCAN/11	Canadian Graphics	95.10

## DOM HARD HAT - TYPE 1

- Smooth dome shape is ideal for welding applications & attachments
- Rain trough & slotted design high density polyethylene shell to accommodate all the latest accessories such as hearing protection, face shields, forestry kits or welding protection
- Attachment points for chin straps
- Comfortable 4-point nylon webbing suspensions
- Large printing surfaces for company logo's on front, sides & back
- Certification(s): ANSI Type I/CSA Type 1

SFY858



SFY732



SFY446



SFY700



Model No.	Mfg. No.	Colour	Price /Each
<b>"SURE-LOCK" RATCHET</b>			
SFY724	HP341R/01	White	18.10
SFY732	HP341R/02	Yellow	18.10
SFY609	HP341R/11	Black	18.10
SFY700	HP341R/15	Red	18.10
SFY858	HP341RCAM/09	Camo	72.60
SFY446	HP341RCAN/11	Canadian Graphics	72.60

## STROMBOLI HARD HAT - TYPE 2

- Safety helmet designed primarily for welders and high heat applications
- Shell is made of lightweight polycarbonate offering exceptional protection against heat, radiation and impacts
- The rain trough free shell is narrower than other models and allows the addition of all types of welding helmets available on the market without any restrictions
- Attachment points for chin straps
- "Sure-Lock" ratchet adjustment to properly fit all head sizes large or small
- Large printing surfaces for company logo's on front, sides & back
- Foam liner adds lateral side, front & rear impact protection
- Certification(s): ANSI Type II/CSA Type 2

SFY815



Model No.	Mfg. No.	Colour	Price /Each
<b>"SURE-LOCK" RATCHET</b>			
SFY821	HP842R/01	White	57.20
SFY824	HP842R/02	Yellow	57.20
SFY794	HP842R/09	Grey	57.20
SFY786	HP842R/11	Black	57.20
SFY815	HP842R/15	Red	57.20
SFY777	HP842R/71	Steel Blue	57.20

## KILIMANJARO HARD HAT - TYPE 1

- Added sun protection to ears & neck from harmful UV rays and protection from falling materials & debris
- Sleek & attractive design
- High density polyethylene shell
- Large printing surfaces for great custom logos on front, sides & back
- Accessory slots & chin strap attachments
- CSA certified Z94.1 Type 1, Class E
- Certification(s): ANSI Type 1/CSA Type 1

SFY689



Model No.	Mfg. No.	Colour	Price /Each
<b>"SURE-LOCK" RATCHET</b>			
SFY726	HP641R/01	White	27.30
SFY734	HP641R/02	Yellow	27.30
SFY689	HP641R/03	Orange	27.30
SFY715	HP641R/07	Sky Blue	27.30
SFY676	HP641R/08	Navy Blue	27.30
SFY610	HP641R/11	Black	27.30
SFY701	HP641R/15	Red	27.30

### ACCESSORIES

SFY887	HP641RS	Replacement Suspension - Ratchet	17.20
--------	---------	----------------------------------	-------

## ROCKY HARD HAT - TYPE 1

- Ultra light shell made out of polycarbonate/ABS while offering you superior protection
- Shell has no front peak providing you a clear upward vision
- Attractive ergonomic shell with fluid curves that do not interfere with the users ears
- Large printing surface for logos
- Redesigned suspension for maximum comfort
- Maximum suspension adjustment to fit small and large heads
- Comfortable 4-point chin strap with easy adjustment
- Universal slots for accessories
- CSA certified Z94.1 Type 1, Class E
- Certification(s): ANSI Type I/CSA Type 1



SFY668

Model No.	Mfg. No.	Colour	Price /Each
<b>"SURE-LOCK" RATCHET</b>			
SFY721	HP141R/01	White	119.00
SFY729	HP141R/02	Yellow	119.00
SFY683	HP141R/03	Orange	119.00
SFY668	HP141R/06	Light blue	119.00
SFY638	HP141R/09	Grey	119.00
SFY605	HP141R/11	Black	119.00

## KILIMANJARO HARD HAT - TYPE 2

- Added sun protection to ears & neck from harmful UV rays and protection from falling materials & debris
- Sleek & attractive design
- High density polyethylene shell
- Large printing surfaces for great custom logos on front, sides & back
- Accessory slots & chin strap attachments
- CSA certified Z94.1 Type 2, Class E
- Certification(s): ANSI Type II/CSA Type 2

SFY814



Model No.	Mfg. No.	Colour	Price /Each
<b>"SURE-LOCK" RATCHET</b>			
SFY820	HP642R/01	White	47.00
SFY823	HP642R/02	Yellow	47.00
SFY809	HP642R/03	Orange	47.00
SFY819	HP642R/07	Sky Blue	47.00
SFY807	HP642R/08	Navy Blue	47.00
SFY785	HP642R/11	Black	47.00
SFY814	HP642R/15	Red	47.00

## ROCKY HARD HAT - TYPE 2

- Ultra light shell made out of polycarbonate/ABS while offering you superior protection
- Shell has no front peak providing you a clear upward vision
- Attractive ergonomic shell with fluid curves that do not interfere with the users ears
- Large printing surface for logos
- Redesigned suspension for maximum comfort
- Maximum suspension adjustment to fit small and large heads
- Comfortable 4-point chin strap with easy adjustment
- Universal slots for accessories
- CSA certified Z94.1 Type 2, Class E
- Certification(s): ANSI Type II/CSA Type 2



SFY779

Model No.	Mfg. No.	Colour	Price /Each
<b>"SURE-LOCK" RATCHET</b>			
SFY778	HP142R/01	White	141.00
SFY779	HP142R/02	Yellow	141.00
SFY775	HP142R/03	Orange	141.00
SFY770	HP142R/04	Dark green	141.00
SFY774	HP142R/06	Light blue	141.00
SFY772	HP142R/09	Grey	141.00
SFY769	HP142R/11	Black	141.00
SFY776	HP142R/15	Red	141.00

## MONT-BLANC HARD HAT - TYPE 2

- Foam liner to offer added lateral front, side & back protection
- Sleek & attractive design
- High density polyethylene shell
- Shell has rain trough for extra convenience
- Large printing surfaces for great custom logos on front, sides & back
- Accessory slots & chin strap attachments
- CSA Z94.1 certified Type 2, Class E
- Certification(s): ANSI Type II/CSA Type 2

Model No.	Mfg. No.	Colour	Price /Each
<b>"SURE-LOCK" RATCHET</b>			
SFY860	HP542R/01	White	38.60
SFY822	HP542R/02	Yellow	38.60
SFY808	HP542R/03	Orange	38.60
SFY818	HP542R/07	Sky Blue	38.60
SFY806	HP542R/08	Navy Blue	38.60
SFY784	HP542R/11	Black	38.60
SFY813	HP542R/15	Red	38.60
SFY801	HP542R/31	Hi-Viz-Orange	38.60
SFY799	HP542R/44	High Visibility Yellow	38.60
<b>ACCESSORIES</b>			
SFY885	HP542RS	Replacement Suspension - Ratchet	17.40

SFY818



SFY801



SFY885



# HARDHATS

## GRAN SLAM II

- For low hazard area protection against minor bumps and lacerations
- Hard shell with crown foam pads for maximum comfort and fit
- Super lightweight
- Well vented for increased comfort during hot, sunny days
- Adjustable to fit most head sizes
- Customizable with your company logo, for an additional charge



Model No.	Mfg. No.	Colour	Price /Each
SGC422	HP946/08	Navy Blue	19.20
SGC423	HP946/15	Red	19.20
SGC424	HP946/09	Grey	19.20
SGC425	HP946/11	Black	19.20

## BUMP CAP

- Super-lightweight
- Flat printing surfaces for great custom logos
- Suspension Type: Pinlock



Model No.	Mfg. No.	Colour	Price /Each
SFY875	HP940/01	White	8.84
SFY876	HP940/02	Yellow	8.84
SFY874	HP940/07	Sky Blue	8.84
SFY873	HP940/15	Red	8.84

## FRONT BRIM HARDHATS

- 4-point ratcheting suspension for quick adjustment and added comfort
- Large ratcheting adjustment range
- Cushioned ratchet and crown pads
- Four Bolt™ accessory slots and two universal accessory slots easily integrate additional personal protection equipment and accessories onto the hard hat
- Bolt™ Marker Clip allows for easy access to pens and markers
- Moisture wicking sweatband to stay cool and dry fast
- Features a Bolt™ Headlamp Mount that works with most headlamps
- Includes a Milwaukee logo decal and identification stickers
- UL third-party tested and certified
- Suspension Type: Ratchet
- Certification(s): CSA Type 1, ANSI Type I



Model No.	Mfg. No.	Colour	Price /Each
VENTED, CLASS C			
SGY509	48-73-1200	White	27.90
SGY508	48-73-1202	Yellow	27.90
SGY510	48-73-1204	Blue	27.90
SGY511	48-73-1206	Green	27.90
SGY512	48-73-1208	Red	27.90
SGY513	48-73-1210	Black	27.90
SGY514	48-73-1212	Orange	27.90
SGY515	48-73-1214	Grey	27.90

Model No.	Mfg. No.	Colour	Price /Each
VENTED, CLASS E			
SGY500	48-73-1100	White	27.90
SGY501	48-73-1102	Yellow	27.90
SGY502	48-73-1104	Blue	27.90
SGY503	48-73-1106	Green	27.90
SGY504	48-73-1108	Red	27.90
SGY505	48-73-1110	Black	27.90
SGY506	48-73-1112	Orange	27.90
SGY507	48-73-1114	Grey	27.90

## FULL BRIM HARDHATS

- 4-point ratcheting suspension for quick adjustment and added comfort
- Large ratcheting adjustment range
- Cushioned ratchet and crown pads
- Four Bolt™ accessory slots and two universal accessory slots easily integrate additional personal protection equipment and accessories onto the hard hat
- Bolt™ Marker Clip allows for easy access to pens and markers
- Moisture wicking sweatband to stay cool and dry fast
- Features a Bolt™ Headlamp Mount that works with most headlamps
- Includes a Milwaukee logo decal and identification stickers
- UL third-party tested and certified
- Suspension Type: Ratchet
- Certification(s): CSA Type 1, ANSI Type I



Model No.	Mfg. No.	Colour	Price /Each
VENTED, CLASS C			
SGY458	48-73-1201	White	34.90
SGY459	48-73-1203	Yellow	34.90
SGY460	48-73-1205	Blue	34.90
SGY461	48-73-1207	Green	34.90
SGY462	48-73-1209	Red	34.90
SGY463	48-73-1211	Black	34.90
SGY464	48-73-1213	Orange	34.90
SGY465	48-73-1215	Grey	34.90

Model No.	Mfg. No.	Colour	Price /Each
VENTED, CLASS E			
SGY450	48-73-1101	White	34.90
SGY451	48-73-1103	Yellow	34.90
SGY452	48-73-1105	Blue	34.90
SGY453	48-73-1107	Green	34.90
SGY454	48-73-1109	Red	34.90
SGY455	48-73-1111	Black	34.90
SGY456	48-73-1113	Orange	34.90
SGY457	48-73-1115	Grey	34.90

## SUPEREIGHT™ P2A ROUGHNECK HARDHATS

- Exceptional impact and crack resistance plus durability
- All day comfort under tough working conditions
- Strip proof ratchet headband
- Exclusive Supereight™ suspension, eight load bearing points balance and stabilize the cap's weight and dissipate force upon impact
- Meets ANSI standard Z89.1, Type 1, Classes C and G
- P2A is high heat resistant to 370°F



Model No.	Mfg. No.	Colour	Price /Each
SAM404	P2AQRW09A000	Grey	57.00
SAM405	P2AQRW74A000	Green	58.20
SAM406	P2AQRW71A000	Blue	57.00

## FREEDOM SERIES™ HARD HATS

- V-Gard® helmet with distinctive "all Canadian" graphics
- Fas-Trac® suspension
- Meet requirements of ANSI Z89.1 for a type I helmet, class E and CSA Z94.1 Type 1, class E
- Canadian Maple Leaf design

Model No. SAM667  
Mfg. No. 10050613  
Price/Each \$51.20





## NORTH ZONE™ FULL-BRIM HARDHATS

- 3-level height adjustment (Low, Medium, High) for greater stability, balance and retention
- Ergonomic headband for easy adjustment to 3 different sizes (S, M/L and XL)
- Moisture-wicking, breathable sweatband; easily removable, washable and replaceable
- Removable, replaceable rear comfort cradle for improved fit and comfort
- Full-brim and low-profile design for increased field of vision and user mobility
- Approved to be worn in the reverse position
- Slots for cap-mounted earmuffs, face shields and other PPE accessories
- Contemporary shell design with four large areas for custom logo imprinting or other
- Suspension Type: Ratchet
- CSA Z94.1 2015 Type I, Class C, G and E



SGG430



Model No.	Mfg. No.	Colour	Price /Each
SGG428	N20R010000	White	42.40
SGG429	N20R020000	Yellow	44.10
SGG430	N20R030000	Orange	44.10
SGG431	N20R040000	Green	44.10
SGG434	N20R080000	Navy Blue	42.40
SGG435	N20R090000	Grey	44.10
SGG437	N20R110000	Black	44.10
SGG440	N20R150000	Red	44.10
SGG442	N20R200000	Pink	43.20
SGG444	N20R460000	Hi-Viz Orange	44.10

## MATTERHORN CSA TYPE 2 HARDHATS

- Foam liner for extra protection from lateral impacts
- Rain trough
- Slotted for attachments
- Ratchet suspension
- Weight: 15.6 oz.
- Certified to standard CSA Z94.1 type 2, Class E



SH347



Model No.	Mfg. No.	Colour	Price /Each
SH347	A89R010000	White	56.50
SH348	A89R020000	Yellow	56.50
SH349	A89R030000	Orange	56.50
SH350	A89R080000	Dark Blue	56.50
SH351	A89R040000	Green	56.50

### ACCESSORIES

SAN022	A89RS2	4-Point Ratchet Suspension	19.20
--------	--------	----------------------------	-------

## BUMP CAPS BC86

- For low hazard area protection against minor bumps and lacerations
- Cool, well-ventilated and lightweight polyethylene construction resists cracking and chipping (not for use in areas requiring hard hat protection)
- One size fits all
- Available in various colours



SAI587



Model No.	Mfg. No.	Colour	Price /Each
SAI586	BC86010000	White	14.90
SAI587	BC86020000	Yellow	15.30
SAI589	BC86080000	Dark Blue	15.30
SEK326	BC86030000	Orange	15.20
SAQ555	BC86040000	Green	15.20

## NORTH ZONE™ HARDHATS

- Slots for cap-mounted earmuffs, face shields and other PPE accessories
- 3-level height adjustment (Low, Medium, High) for greater stability, balance and retention
- Removable, replaceable rear comfort cradle for improved fit and comfort
- Easy-grip ratchet for smooth and precise headband adjustment, even when wearing gloves
- Ergonomic headband for easy adjustment to 3 different sizes (S, M/L and XL)
- Moisture-wicking, breathable sweatband; easily removable, washable and replaceable
- Short brim and low-profile design for increased field of vision and user mobility
- Approved to be worn in the reverse position
- Suspension Type: Ratchet
- Certification(s): ANSI Type I/CSA Z94.1 Type 1



SFM518



Model No.	Mfg. No.	Colour	Price /Each
SFM517	N10R010000	White	26.30
SFM518	N10R020000	Yellow	26.30
SFM519	N10R030000	Orange	26.30
SFM520	N10R040000	Green	26.30
SFM523	N10R080000	Navy Blue	27.30
SFM524	N10R090000	Grey	26.30
SFM526	N10R110000	Black	26.30
SFM529	N10R150000	Red	26.30
SFM533	N10R460000	Hi-Viz Orange	27.30

## THE EVEREST A119R CSA TYPE 2 HARDHATS

- Provide protection from top, sides, front and back
- High-density polyethylene outer shell
- Universal slots
- Full all around brim for UV ray and rain protection
- Expanded polystyrene inner shell
- Ergonomically designed 6-point suspension with 2 adjustment levels
- Sliding mechanism on the rear for centering of the helmet on the head
- Ratchet mechanism fits head sizes 6 to 8
- Crown pad and sweatband for user comfort
- Weighs 17.4 oz.
- Certified to standard CSA Z94.1 type 2, Class E



SE936



SE938



Model No.	Mfg. No.	Colour	Price /Each
SE933	A119R010000	White	76.20
SE935	A119R030000	Orange	77.80
SE936	A119R070000	Sky Blue	77.80
SE937	A119R110000	Black	77.80
SE938	A119R150000	Red	77.80
SAN168	A119R080000	Navy	77.80

# HARDHATS

## TOPGARD® PROTECTIVE CAPS

### UNI-RIDGE DESIGN PROTECTS WEARER FROM FALLING OBJECTS

Lightweight, durable Topgard® slotted caps are built for use by utilities and other industries, where head protection from falling objects is necessary, along with good dielectric properties (non-conduction of electrical current). Limited resistance to top impact or penetration is retained through a wide range of temperatures.

Available in standard (6 1/2 - 8) size with 1-Touch™ or Fas-Trac® suspension. Topgard® caps meet or exceed the applicable requirements for a type I helmet (top impact) as outlined in ANSI Z89.1 and CSA Z94.1, class E.



Model No.	Mfg. No.	Colour	Price /Each
<b>1-TOUCH™ SUSPENSION</b>			
SAM569	454728	White	44.80
SAM571	454723	Blue	44.80
SAM572	454721	Yellow	44.80
SAM573	454725	Orange	44.80
SAM574	454727	Red	44.80
SAM575	454726	Green	44.80
SAM576	454722	Grey	44.80
<b>FAS-TRAC® SUSPENSION</b>			
SAG002	475385	White	55.90
SAG003	475380	Blue	55.90
SAG004	475378	Yellow	55.90
SAG005	475382	Orange	55.90

### REPLACEMENT SUSPENSIONS

Model No.	Mfg. No.	Description	Price /Each
SAM577	10061127	1-Touch™ Suspension	15.10
SEL240	10153384	Fas-Trac® III Suspension	25.60

## V-GARD® C1™ HARDHATS

- Uses patent-pending ReflectIR™ Thermal Barrier technology to keep the inside of the hard hat up to 20°F (11°C) cooler in sunny weather
- Full brim with 12% greater coverage provides additional shade and sun protection
- Premium moisture-wicking sweat band with breathable foam padding
- Large vents with strategic placement enable improved air flow
- Suspension Type: Ratchet
- Certification(s): CSA Type 1, ANSI Type I
- Material: Polyethylene
- Size: 20.5" - 25" Head Circumference
- Manufacturer's Warranty: 1 Year



Model No.	Mfg. No.	Colour	Price /Each
<b>VENTED, CLASS C</b>			
SGZ816	10215828	White	79.30
SGZ817	10215829	Red	79.30
SGZ818	10215830	Blue	79.30
SGZ819	10215831	Green	79.30
SGZ820	10215832	Yellow	79.30
SGZ821	10215834	Orange	79.30
SGZ822	10215835	Black	79.30
SGZ823	10215836	Grey	79.30
SGZ824	10215833	High Visibility Orange	79.30

Model No.	Mfg. No.	Colour	Price /Each
<b>VENTED, CLASS E</b>			
SGZ825	10215837	White	79.30
SGZ826	10215838	Red	79.30
SGZ827	10215839	Blue	79.30
SGZ828	10215840	Green	79.30
SGZ829	10215841	Yellow	79.30
SGZ830	10215843	Orange	79.30
SGZ831	10215844	Black	79.30
SGZ832	10215845	Grey	79.30
SGZ833	10215842	High Visibility Orange	79.30

## V-GARD® PROTECTIVE CAPS

### OFFER COMFORTABLE, LIGHTWEIGHT PROTECTION

- V-Gard® protective caps from MSA consist of a polyethylene shell and suspension system working together as a protection system.
- V-Gard® headwear features slotted sides and advanced styling in standard (6 1/2 - 8) size.
- Available with Fas-Trac® or 1-Touch™ suspension.
- Caps meet or exceed the applicable requirements for a type I helmet (top impact) as outlined in ANSI Z89.1 and CSA Z94.1, class E.



Model No.	Mfg. No.	Colour	Price /Each
<b>FAS-TRAC® SUSPENSION</b>			
SAF970	475358	White	16.90
SAF971	475359	Blue	16.90
SAF972	475360	Yellow	16.90
SAF973	475361	Orange	16.90
SAF974	475363	Red	16.90
SAF975	475362	Green	16.90
SAF976	475364	Grey	16.90
SAF977	488146	Hi-Viz Orange	16.90
SAF978	815565	Lime Green	16.90
SDL113	10061512	Hi-Viz Yellow Green	16.90
SAF981	492559	Black	16.90
<b>1-TOUCH™ SUSPENSION</b>			
SAM578	10057441	White	12.90
SAM579	10057442	Blue	12.90
SAM580	10057443	Yellow	12.90
SAM581	10061514	Hi-Viz Lime Green	12.90

## V-GARD® FULL BRIM HARDHATS

- Polyethylene shell provides superior impact protection
- Self-adjusting crown straps ensure a comfortable fit
- Fas-Trac® III suspension
- Slotted design works with MSA accessories
- Third party tested to meet ANSI/ISEA Z89.1 and CSA Z94.1, Class E requirements



SDL497



Model No.	Mfg. No.	Colour	Price /Each
SDL493	475366	Yellow	29.60
SDL494	475367	Navy Grey	29.60
SDL495	475368	Blue	29.60
SDL496	475369	White	29.60
SDL497	475370	Green	29.60
SDL498	475371	Red	29.60

## TOPGARD® FULL BRIM HARDHATS

- Built for use by utilities and other industries where head protection with dielectric protection is necessary
- Withstands radiant heat loads up to 275°F
- Fas-Trac® III suspension
- Slotted hardhat
- Third party tested to meet ANSI/ISEA Z89.1 and CSA Z94.1, Class E requirements



SDL489



Model No.	Mfg. No.	Colour	Price /Each
SDL487	475387	Yellow	58.90
SDL488	475388	Grey	58.90
SDL489	475389	Blue	58.90
SDL490	475391	Green	58.90
SDL491	475392	Red	58.90
SDL492	475394	Black	58.90

## WORKER STARTER KITS

- Ideal for outfitting temporary workers

### MEN'S WORKER STARTER KIT

- **Kit includes:** Hard hat, safety glasses, work gloves, ear plugs, respirator
- Hard hat: CSA type 1 with ratchet suspension
- Safety glasses: I/O blue mirror compliant with CSA standard
- Ear plugs: Corded CSA class AL with NRR rating of 32 dB
- Gloves: Split cowhide patch palm leather
- Respirator: NIOSH N95 approved

Model No.	Hard Hat Colour	Price /Each
SEH890	Yellow	32.95
SEH891	White	32.95
SEH892	Blue	32.95

### LADIES' WORKER STARTER KITS

- **Kit includes:** Hard hat, safety glasses, work gloves, ear plugs, respirator
- Hard Hat Certification(s): ANSI Type I / CSA Type 1
- Hard Hat Suspension Type: Ratchet
- Safety Glasses Standard(s) Met: Meet ANSI Z87+ / CSA Z94.3
- Safety Glasses Style: Grey/Smoke Lens Tint & Anti-Scratch Coating
- Work Glove Style: Premium Split Cowhide
- Ear Plugs Certification(s): ANSI S3.19-1974/CSA Class AL
- Ear Plugs NRR dB rating: 30

Model No.	Hard Hat Colour	Price /Each
SGH559	Pink	36.95
SGH560	White	32.95
SGH561	Yellow	32.95



## SQUIDS® HARD HAT LANYARDS

- Comfortably attaches to hard hats and other headwear to prevent the item from falling
- Buckle connecting lanyards feature a double lock plastic buckle that attaches to your fall protection
- Maximum safe working capacity: 2 lbs. (0.9 kg)
- Third party tested using a 2:1 safety factor
- Hard hat not included

SED573



### SQUIDS® 3150 & 3155 STANDARD LANYARDS

- High-stretch elastic material allows workers to move their head freely

### SQUIDS® 3157 & 3158 COIL LANYARDS

- Coil design reduces lanyard length and prevents snag and tangle hazards while maintaining the workers range of motion



SDL091



Model No.	Mfg. No.	Colour	Connection Type	Price /Each
<b>STANDARD LANYARDS</b>				
SED573	19150	Lime	Buckle	8.69
SED574	19155	Lime	Clamp	8.69
<b>COIL LANYARDS</b>				
SDL089	19156	Black	Buckle	9.81
SDL090	19157	Lime	Buckle	9.81
SDL091	19158	Black	Clamp	9.81
SDL092	19159	Lime	Clamp	9.81

## SWEATBANDS

- Cool and comfortable solution for hot workplace environments
- Soft, reinforced sponge to absorb perspiration
- Waffled sponge provides added durability with gauze scrim-reinforced design
- Durable 14" nylon elastic band "box-stitched" into sponge material helps keep sweatband in place
- For workers who wear head or face protection all day
- Dimensions: 8 5/8" x 1 3/4"

SAI910



Model No.	Mfg. No.	Description	Qty/ Pkg	Price /Each
SAI910	16750	Sweatband	25	53.70

## FL85 HEADLAMPS

- Hinged beam allows for quick and easy light beam adjustment
- Hardhat compatible
- Dual colour mode allows for great visibility in low light situations and offers bright, long distance illumination
- Reflective strap provides additional visibility on low lighting
- IPX4 weatherproof rating
- Lamp Type: LED
- Lamp Material: Plastic
- Run Time Hrs. (High): 2.25
- Run Time Hrs. (Low): 13
- Battery Type: AAA
- Body Colour: Black
- Beam Distance (High): 183 m
- Beam Distance (Low): 77 m
- Batteries included
- Light Colour: Red, White
- Dual Colour Mode: Red and White Beam
- Beam Optic: Pure Beam



Model No.	Mfg. No.	Lumens High/Low	Price /Each
XE988	21190	615/96	70.89

## HEADGEAR PADS & SWEATBANDS

- Headgear pads are field tested to improve helmet grip with maximum perspiration absorption
- Headgear pads are flame retardant for added safety
- Made of an absorbent air cushioned layer lined with 100% fleece cotton
- Velcro fastening system is designed to fit all major brands of headgear
- Sweatbands come with elastic strap
- **Sold per package of 2**



Sweatband



Suspender headgear



Non-suspender headgear

Model No.	Description	Price /Each
620-3200V	Suspender Pads for Use with Hard Hats	4.55
SAM548	Sweatbands	4.55
620-3100V	Non-Suspender Pads for Use with Welding Helmets	4.55



# HEADLAMPS

## SEPTOR® HEADLAMPS

- Hands-free headlamp features LEDs lighting that amply illuminate the task at hand
- 90° tilting head for task targeting
- 7 bright white LEDs that have a 100 000 hour lifetime and never needs to be replaced
- 3 brightness levels - 7 LEDs, 3 LEDs, 1 LED
- Water resistant
- **Includes:** 3 AAA alkaline batteries, elastic headstrap and rubber hard hat strap



Model No.	Mfg. No.	Description	Price /Each
XC389	61052	Industrial Headlamp	71.90



## TRIDENT® HEADLAMPS

- 3-way headlamp with rubber and elastic straps
- Features 1 high powered LED and 3 ultra bright white LEDs within the same reflector - all with 100 000 hour lifetimes
- 90° tilting head
- Low Battery Indicator – Red LED flashes when battery voltage is low
- Water resistant, lightweight thermoplastic construction with push-button switch
- **Includes:** 3 AAA alkaline batteries and both elastic and rubber hard hat straps



Model No.	Mfg. No.	Description	Price /Each
XC388	61050	Industrial Headlamp	55.90



## ARGO® HEADLAMPS

- Long-range headlamp with a far reaching beam of 190 meters (high)
- 150 lumens
- 3 lighting modes: High for maximum output long-range beam distance, medium for intense brightness, and low for extended run times
- Run time: High: 3 hours
- Low Battery Indicator – Red LED flashes when battery voltage is low
- Water resistant, lightweight thermoplastic construction with push-button switch
- **Includes:** 3 AAA alkaline batteries and both elastic and rubber hard hat straps



Model No.	Mfg. No.	Description	Price /Each
SEJ181	61301	Industrial Headlamp	69.90



## 3AA HAZ-LO® HEADLAMPS

- Streamlight®'s first safety approved LED headlamp for Class 1, Div 1 hazardous locations
- Contains a 1 Watt super high-flux LED
- LED has a 50 000 hour lifetime and never needs to be replaced
- Brightness: 120 lumens
- Run time: Up to 11 hours of continuous use
- O-ring sealed for weather-resistance
- 90° tilting head
- UL Classified for Class I, Division 1, Groups A, B, C, D, Temperature Code T4
- **Includes:** 3 AA Alkaline batteries; 2 head straps - rubber and elastic



**Model No. XC391**  
**Mfg. No. 61200**  
**Price/Each \$95.90**



## CREE® LED HEADLAMP

- 3 settings: High, Low and Strobe
- Head angle is adjustable
- Adjustable in/out zoom
- Water resistant
- Batteries Required: 3 AAA
- Lumens (High): 120
- Run Time Hrs. (High): 6
- Lamp Colour: Black
- Beam Distance (High): 120 m
- Batteries Not Included
- Run Time Hrs. (Low): 20
- Lumens (Low): 30

**Model No. XE887**  
**Price/Each \$28.50**



XE887

## EXPLOSION-PROOF HEADLIGHTS

- Totally enclosed, chemical resistant light
- Includes adjustable strap that mounts the light on a hard hat
- Fits comfortably directly on worker's head
- Lamp housing swivels 45° for accurate aim
- Operates for approximately 4 hours on four AA batteries (not included)
- Weight with batteries: 7.6 oz

**Model No. XA036**  
**Mfg. No. HL-X**  
**Price/Each \$79.90**



## REPLACEMENT BATTERIES AA

1.5 V, 24/pkg. - Priced per Package

**Model No. XB872**  
**Mfg. No. EN91**  
**Price/Each \$18.00**



## AURORA TOOLS

### LED HEADLAMP

- 7 ultra bright LED lights
- 3 brightness levels – 7 LEDs, 3 LEDs, 1 LED
- Water resistant
- Lightweight design
- Tilting head and adjustable head strap
- Battery type: AAA
- Batteries required: 3 AAA
- Batteries not included
- Lumens: 21
- Beam Distance: 10m (33')

**Model No. XC658**  
**Price/Each \$11.50**



Hard hat not included



## HD VISION INDUSTRIAL HEADLAMP

- Three light modes: White spot light, white flood light and spot and flood together
- Dimmable to control brightness and runtime
- Powerful beam: Up to 4X brighter than standard LED technology
- Beam distance: 55 m
- Pivots to direct light where you need it
- Durable light is water resistant with a shatterproof lens
- Includes 3 AAA Energizer® MAX® batteries
- NON SLIP RUBBER GRIP (HOLDS TIGHT ON HELMETS)
- Lumens: High: 300, Low: 45
- Run time hrs.: High: 4.33, Low: 35











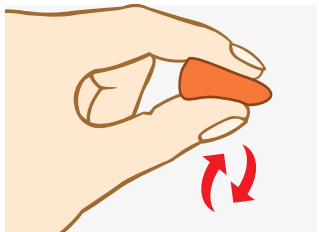
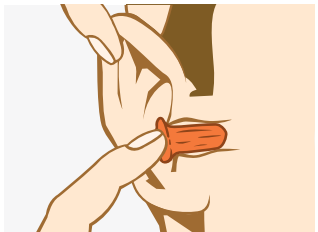
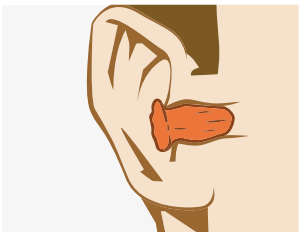

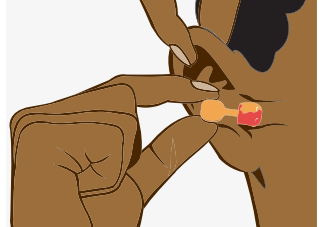
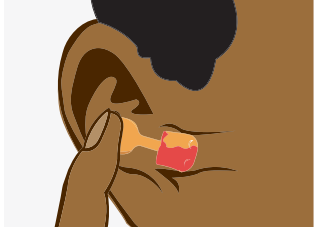
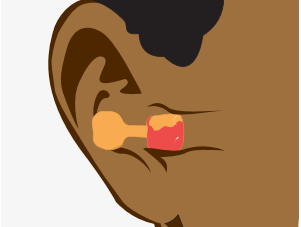
**Model No. SDM001**  
**Mfg. No. HDBIN32E**  
**Price/Each \$26.71**

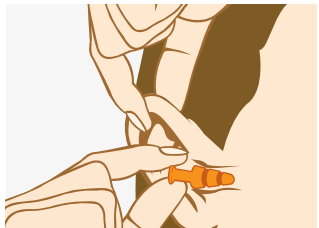

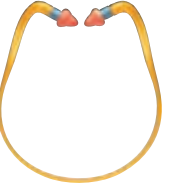
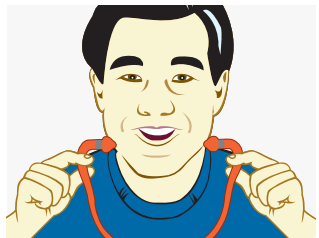
## Earplugs Fitting Instructions

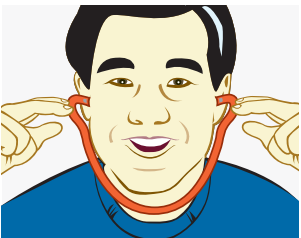

Keys to Successful Hearing Protection with Earplugs

<p><b>1 Disposable</b></p> <p>Roll-Down Foam      MAX®</p> 	 <p>With clean hands, roll the entire earplug into narrowest possible crease-free cylinder.</p>	 <p>Reach over your head with a free hand, pull your ear up and back, and insert the earplug well inside your ear canal.</p>	 <p>Hold for 30 - 40 seconds, until the earplug fully expands in your ear canal. If properly fitted, the end of the earplugs should not be visible to someone looking at you from the front.</p>	
<p><b>2 Reusable</b></p> <p>Push-In Foam      Trust Fit™</p> 	 <p>While holding the stem, reach a hand over your head and gently pull the top of your ear up and back.</p>	 <p>Insert earplug so foam tip is well inside the ear canal. Use a gentle rocking motion while pushing earplug into ear canal to ensure a deep fit.</p>	 <p>If properly fitted, the tip of the earplug stem may be visible to someone looking at you from the front.</p>	
<p><b>3 Reusable</b></p> <p>Pre-Molded Push-In      SmartFit®</p> 	 <p>While holding the stem, reach a hand over your head and gently pull top of your ear up and back.</p>	 <p>Insert the earplug so all flanges are well inside your ear canal.</p>	 <p>If properly fitted, the tip of the earplug stem may be visible to someone looking at you from the front.</p>	
<p><b>4 Banded</b></p> <p>Tension Fit      QB2®HYG</p> 	 <p>Position band under your chin as shown above. Use your hands to press the ear pods well into the ear canal using an inward motion.</p>	 <p>Protection levels are improved by pulling your ear up and back when fitting as shown.</p>	 <p>In a noisy environment, lightly press the band inward with your fingertips as shown. You should not notice a significant difference in noise level.</p>	
<p><b>DOs and DON'Ts of Howard Leight Earplugs</b></p>		<p><b>Proper Fit</b> If either or both earplugs do not seem to be fitted properly, remove the earplug and reinsert.</p> 	<p><b>Removal</b> Gently twist earplug while slowly pulling in an outward motion for removal.</p> 	<p><b>Acoustical Check</b> In a noisy environment, with earplugs inserted, cup your hands over your ears and release. Earplugs should block enough noise so that covering your ears with your hands does not result in a significant noise difference.</p> 

### WEAR

- Read and follow all earplug fitting instructions.

### SELECTION

- Avoid overprotection in minimal noise environments – in selecting the best earplug for your situation, consider noise levels and your need to communicate with co-workers or hear warning signals on the job.

### MAINTENANCE

- Prior to fitting, inspect earplugs or ear tips for dirt, damage, or hardness. Discard & replace immediately if compromised.
- For proper hygiene discard disposable earplugs after use.
- With proper maintenance reusable earplugs should be replaced every 2-4 weeks. Push In Foam earplugs should be replaced every 5 days.
- Wash with mild soap/water, pat dry or air dry, and store in a case when not in use.
- Clean regularly and replace ear tip pods every 2-4 weeks on banded earplugs.

# EARPLUGS

## BIOSOFT™ BIOBASED EARPLUGS

- Independently tested to NRR 32, SNR 38
- All parts are biobased
- Soft, smooth, low pressure for dreamlike comfort
- Made in North America with American and Canadian materials
- USDA Certified Biobased Product
- NRR dB: 32
- One-Size
- Certification(s): CSA Class AL

Priced per box

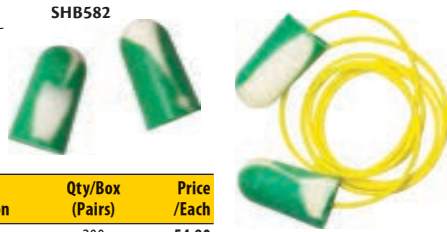

Model No.	Mfg. No.	Description	Qty/Box (Pairs)	Price /Each
SHB582	BSF-1	Uncorded	200	54.90
SHB583	BSF-30	Corded	100	48.50



## PINCHFIT™ BIOBASED EARPLUGS

- Independently tested to NRR 32, SNR 38
- All parts are biobased
- Easier, more hygienic fit
- Soft, smooth, low pressure for dreamlike comfort
- Made in North America with American and Canadian materials
- NRR dB: 32
- One-Size
- Certification(s): CSA Class AL

Priced per box

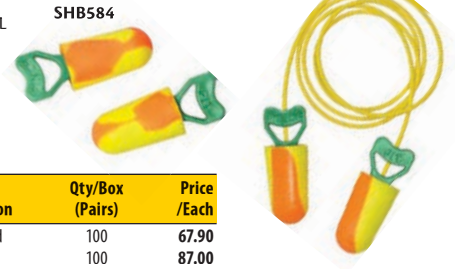

Model No.	Mfg. No.	Description	Qty/Box (Pairs)	Price /Each
SHB584	PF-1	Uncorded	100	67.90
SHB585	PF-30	Corded	100	87.00

## MAXIMUM FOAM EARPLUGS

- The world's most-used polyurethane foam earplug
- Bell shape delivers maximum in-ear comfort
- Contoured design easier to insert, resists tendency to back-out of ear canal
- Polyurethane foam enhances comfort, especially for long-term wear
- Smooth, soil-resistant skin prevents dirt build-up
- Attenuation tested in accordance with ANSI S3.19-1974
- NRR 33 dB, CSA Class AL

Priced per box

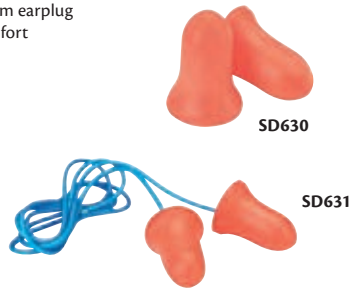

Model No.	Mfg. No.	Description	Qty/Box (Pairs)	Price /Each
SD630	MAX-1	Uncorded	200	49.10
SD631	MAX-30	Corded	100	46.40

**Honeywell**  
HOWARD LEIGHT

## LASER LITE® MULTI-COLOUR FOAM

- Vibrant colours make protection visible
- Self-adjusting polyurethane foam expands to fit virtually every wearer
- Contoured T-shape for easy insertion and wear
- Smooth, soil-resistant skin prevents dirt build-up
- Attenuation tested in accordance with ANSI S3.19-1974
- NRR 32 dB, CSA Class AL

Priced per box

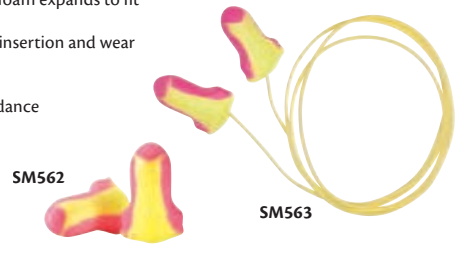

Model No.	Mfg. No.	Description	Qty/Box (Pairs)	Price /Each
SM562	LL-1	Uncorded, Poly Bag	200	40.70
SM563	LL-30	Corded, Poly Bag	100	39.40

**Honeywell**  
HOWARD LEIGHT

## FIRMFIT™ SINGLE USE EARPLUGS

- Low pressure foam
- Exerts low expansion pressure on the ear canal
- Slow recovery rate gives you plenty of time to correctly insert in ear canal
- Distinct warning orange colour makes compliance checks easy
- NRR 30 dB, CSA Class AL

Priced per box

**Honeywell**  
HOWARD LEIGHT

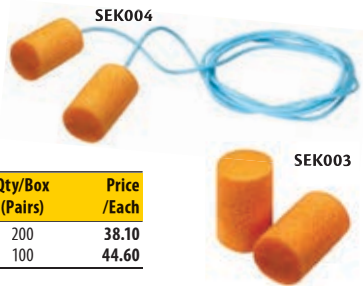

Model No.	Mfg. No.	Description	Qty/Box (Pairs)	Price /Each
SEK003	FF-1	Uncorded, Poly Bag	200	38.10
SEK004	FF-30	Corded	100	44.60

## MAXIMUM LITE LOW-PRESSURE FOAM EARPLUGS

- Ideal size for workers with smaller ear canals
- Low pressure polyurethane foam expands gently for comfortable long-term wear
- Contoured T-shape for easy handling and wear
- Smooth, soil-resistant skin prevents dirt build-up
- Attenuation tested in accordance with ANSI S3.19-1974
- NRR 30 dB, CSA Class AL

Priced per box

Model No.	Mfg. No.	Description	Qty/Box (Pairs)	Price /Each
SM558	LPF-1	Uncorded, Poly Bag	200	41.80
SM559	LPF-30	Poly Cord, Poly Bag	100	39.60



**Honeywell**  
HOWARD LEIGHT

## LASER-TRAK® METAL DETECTABLE EARPLUGS

- Self-adjusting foam expands to fit virtually every wearer
- Non-ferrous metal and bright colours are easily detected by visual and automated inspections
- Blue metalized cord offers additional protection in highly sensitive production areas
- Contoured T-shape for easy handling and wear
- Comfortable long term wear
- NRR 33 dB, CSA Class AL

Priced per box

Model No.	Mfg. No.	Description	Qty/Box (Pairs)	Price /Each
SAK189	LT-30	Corded, Polybag	100	59.00



**Honeywell**  
HOWARD LEIGHT

## E-A-RSOFT METAL DETECTABLE EARPLUGS

- Advanced foam formulation that provides low-pressure comfort
- Both the cord and the plugs are metal detectable
- NRR dB: 32
- Size: Regular
- Certification(s): CSA Class AL
- Packaging: Bulk - Polybag

Priced per box



Model No.	Mfg. No.	Description	Qty/Box (Pairs)	Price /Each
SAF802	311-4106	Corded	200	141.01





## E-A-R<sup>TM</sup> SOFT YELLOW NEON & YELLOW NEON BLASTS EARPLUGS

- Advanced foam formulation that provides low-pressure comfort
- Available uncorded or with breakaway cord
- Two sizes available for optimum comfort and protection
- Yellow E-A-R<sup>TM</sup> trademark colour assures proven protection and high quality
- Laboratory tested NRR 33 dB
- Also available in Yellow Neons<sup>TM</sup> metal detectable
- Both the cord and the plugs are metal detectable
- CSA class AL

Priced per box



Model No.	Mfg. No.	Description	Size	Qty/Box (Pairs)	Price /Each
<b>UNCORDED</b>					
SJ423	312-1250	Yellow Neon	Regular	200	39.80
SJ425	312-1251	Yellow Neon	Large	200	48.20
SJ427	312-1252	Yellow Neon Blasts	Regular	200	57.50
<b>CORDED</b>					
SJ424	311-1250	Yellow Neons	Regular	200	81.00
SJ426	311-1251	Yellow Neons	Large	200	98.60
SJ428	311-1252	Yellow Neon Blasts	Regular	200	118.20

## TAPERFIT 2 FOAM EARPLUGS

- Self-adjusting polyurethane foam provides low-pressure comfort with excellent attenuation
- Dermatologically safe and non-irritating foam
- NRR 32 dB, CSA Class AL
- Available in two sizes: Regular and Plus

Priced per box

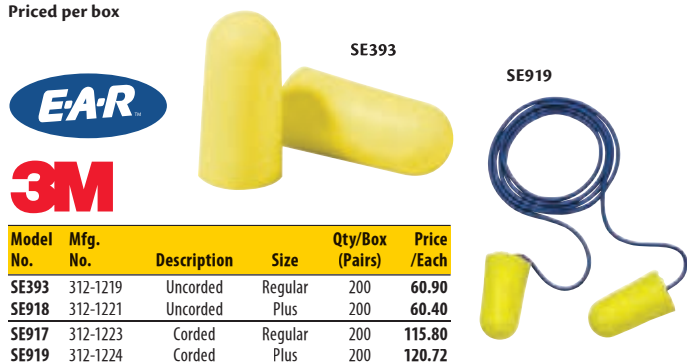

Model No.	Mfg. No.	Description	Size	Qty/Box (Pairs)	Price /Each
SE393	312-1219	Uncorded	Regular	200	60.90
SE918	312-1221	Uncorded	Plus	200	60.40
SE917	312-1223	Corded	Regular	200	115.80
SE919	312-1224	Corded	Plus	200	120.72

## FOAM EARPLUGS

- Individually packaged for convenience
- Smooth, dirt resistant surface
- Soft hypo-allergenic polyurethane foam offers superior comfort
- NRR 29 dB, CSA Class AL
- Bright orange for visibility

Priced per box

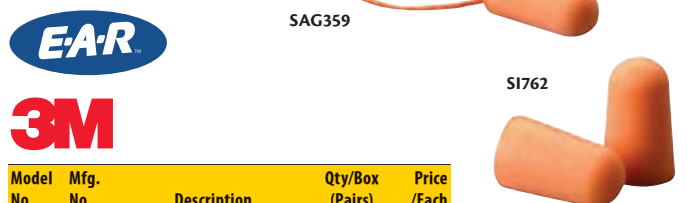

Model No.	Mfg. No.	Description	Qty/Box (Pairs)	Price /Each
S1762	1100	Uncorded	200	42.00
SAG359	1110	Corded	100	53.20

## E-A-R<sup>TM</sup> CLASSIC FOAM EARPLUGS

- Slow recovery PVC foam provides comfort with low pressure
- Moisture resistant and the foam will maintain its comfort, fit and critical recovery characteristics
- Shape equalizes pressure throughout the ear canal as it expands
- Flame retardant and dermatologically safe foam is not irritating
- The Classic<sup>TM</sup> Plus offers the highest NRR, 33 dB, has a longer high performance foam plug for increased protection and fits more deeply into the ear canal.
- The Classic<sup>TM</sup> Small has a more narrow design for smaller ear canal
- One size fits all
- Colour: Yellow
- CSA Class AL

Priced per box



Model No.	Mfg. No.	Description	NRR dB	Qty/Box (Pairs)	Price /Each
<b>UNCORDED</b>					
SA681	310-1001	Foam - Pillow	29	200	56.60
SH107	310-1101	Plus Foam	33	200	59.59
SH109	310-1103	Small Foam	29	200	59.33
SAJ486	312-1201	Polybag	29	200	50.60
<b>CORDED</b>					
SE649	311-1101	Foam	29	200	105.20
SH108	311-1105	Plus Foam	33	200	119.38
SH110	311-1106	Small Foam	29	200	117.21

## E-A-R<sup>TM</sup> PUSH-INS EARPLUGS

- Easy fit with no roll down required
- E.A.R.form<sup>TM</sup> yellow foam tip for ultimate comfort
- Blue stem allows for hygienic insertion and removal
- CSA Class AL
- NRR 28 dB

Priced per box

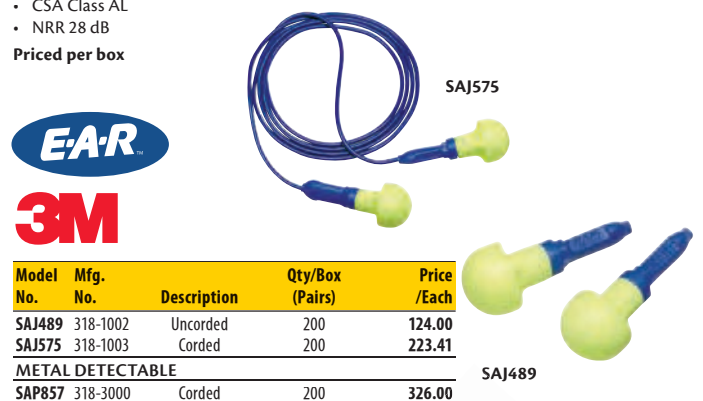

Model No.	Mfg. No.	Description	Qty/Box (Pairs)	Price /Each
SAJ489	318-1002	Uncorded	200	124.00
SAJ575	318-1003	Corded	200	223.41
<b>METAL DETECTABLE</b>				
SAP857	318-3000	Corded	200	326.00

## SKULL SCREWS EARPLUGS

- Easy grip for clean insertion
- Look of metal, soft feel of foam
- The screw "threads" help achieve an optimum noise seal
- NRR 32 dB, CSA Class AL

Priced per box

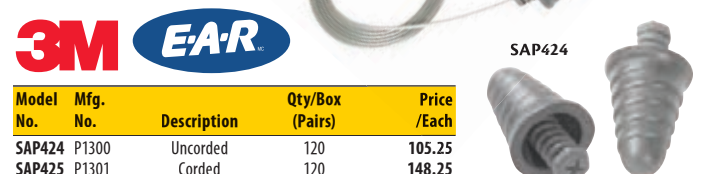

Model No.	Mfg. No.	Description	Qty/Box (Pairs)	Price /Each
SAP424	P1300	Uncorded	120	105.25
SAP425	P1301	Corded	120	148.25

# EARPLUGS

## E-Z-FIT™ EARPLUGS

### COMFORTABLE FIT FOR SMALLER EAR CANALS!

- Low pressure, soft smooth polyurethane foam is easy to roll and self-adjusting for increased user comfort, with no full feeling in the ear
- Bell-shaped design with a wide flange allows for easy insertion and removal
- Designed to fit medium and small ear canals with increased comfort
- Safe and non-irritating to the ear canal
- Laboratory tested NRR 28 dB
- Available one pair per poly bag uncorded or with breakaway cord
- CSA Z94.2 + CSA Class AL

Priced per box



Model No.	Mfg. No.	Description	NRR dB	Qty/Box (Pairs)	Price /Each
SH114	312-1208	Uncorded	28	200	60.60
SH115	312-1222	Corded	28	200	114.20



## SOOTHERS™ MOISTURIZING DISPOSABLE EARPLUGS

- Hydrates and moisturizes for all day comfort
- Extra-soft low-pressure foam for comfort and fit
- Tapered shape for easy insertion and removal
- Shaped to fit even very small ear canals
- Non-irritating smooth surface
- 100% PVC-Free for a greener alternative
- NRR dB: 33
- Size: One-Size
- Certification(s): CSA Class AL

Priced per box

Model No.	Mfg. No.	Description	Qty/Box (Pairs)	Price /Each
SGP545	6680	Uncorded	200	77.80



## GLIDE® FOAM SOOTHERS TWIST-IN MOISTURIZING EARPLUGS

- Moisturizes for all day comfort
- Unique multi-curved stem rotates for a custom fit
- Large handle on curved stem for easy insertion and removal
- Cord can be attached at any desired length
- 100% PVC-free
- NRR dB: 31
- Size: One-Size
- Certification(s): ANSI S3.19-1974, CSA Class AL

Priced per box

Model No.	Mfg. No.	Description	Qty/Box (Pairs)	Price /Each
SGQ908	6980	Uncorded	100	107.00
SGQ909	6985	Corded	100	151.00

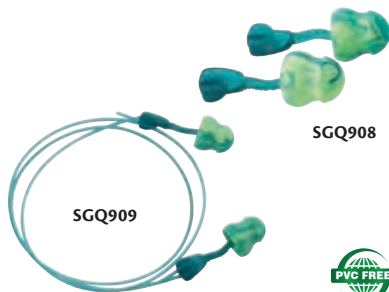

## GLIDE™ FOAM EAR PLUGS

- Unique multi-curved stem rotates for a custom fit
- Large handle on curved stem for easy insertion and removal
- Cord can be attached at any desired length
- 100% PVC-free, like all Moldex products and packaging, for a greener alternative
- NRR 30 dB, CSA Class AL

Priced per box

Model No.	Mfg. No.	Description	Qty/Box (Pairs)	Price /Each
SEH047	6940	Uncorded	100	78.20
SEH048	6945	Corded	100	114.00



## E-A-RSOFT FX EARPLUG

- Made of a custom polyurethane formulation for slow recovery and increased softness in the ear canal
- CSA Class AL
- NRR 33 dB

Priced per box



Model No.	Mfg. No.	Description	Qty/Box (Pairs)	Price /Each
SAH584	312-1260	Corded	200	84.40
SAH585	312-1261	Uncorded	200	45.40

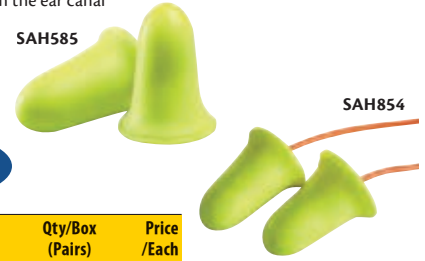

## NO-TOUCH FOAM EAR PLUGS

- Innovative push-to-fit design eliminates need for rolling the foam tip
- Softness and comfort of a foam earplug without the hassle of rolling it down
- No reason to touch the foam for clean and comfortable protection
- NRR 29 dB, CSA Class AL

Priced per box



Model No.	Mfg. No.	Description	Qty/Box (Pairs)	Price /Each
SAK145	P2000	Uncorded	100	82.00
SAK146	P2001	Corded	100	135.25



## SPARKPLUGS® MULTI-COLOURED FOAM EARPLUGS

- Different colours in every package
- Fun coloured to spark up hearing protection program
- Tapered for easy insertion in any size ear canal
- Non-irritating, smooth surface for added comfort
- NRR 33 dB, CSA Class AL

Priced per box



Model No.	Mfg. No.	Description	Qty/Box (Pairs)	Price /Each
SAG838	6604	Uncorded	200	50.40
SAG839	6654	Corded	100	55.70
SED129	6615	Corded, metal detectable	100	89.20



## PURA-FIT® FOAM EARPLUGS

- Longer length for easy fitting and removal
- Tapered for easy insertion in any size ear canal
- Non-irritating, smooth surface for added comfort
- Bright green colour as a symbol of Moldex® quality
- NRR 33 dB, CSA Class AL

Priced per box



Model No.	Mfg. No.	Description	Qty/Box (Pairs)	Price /Each
SR831	6800	Uncorded	200	60.10
SAG837	6900	Corded	100	62.80

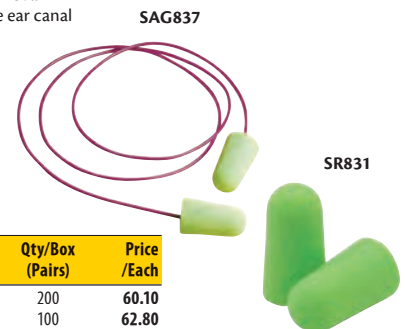

## ANTIMICROBIAL EARPLUG DISPENSER

- Universal hole positions – eliminates the need to drill new holes
- Durable, recyclable plastic canister – an economical choice for dispensing earplugs
- Easy twist knob with 180° of access – makes dispensing earplugs easy
- Earplugs sold separately



**Honeywell**  
HOWARD  
LEIGHT

Model No.	Mfg. No.	Description	Price /Each
SHJ971	HL400-AM	Antimicrobial Earplug Dispenser	54.05

### REFILL CANISTERS

Priced per Canister

Model No.	Description	NRR dB	Pairs /Refill	Qty /Case	Price /Each
SGC415	Maximum Earplugs	33	400	2	96.10
SGC417	Maximum Lite Earplugs	30	400	2	77.50
SGC418	Laser Lite® Single-Use Earplugs	32	400	2	78.90
SGC419	FirmFit® Single-Use Earplugs	30	400	2	95.90

### BULK REFILLS

Priced per Box

Model No.	Description	NRR dB	Pairs /Refill	Qty /Case	Price /Each
SAO209	Maximum Single-Use Earplugs	33	200	10	41.90
SAO210	Maximum Lite Single-Use Earplugs	30	200	10	39.50
SAO211	Laser Lite® Single-Use Earplugs	32	200	10	36.30

## ONE TOUCH™ PRO EARPLUG DISPENSERS

- Patented "No Waste Funnel" allows users to reuse base and dispenser
- Can be used as a table top or wall mounted
- Easy access for the user from all sides
- Earplug refill bottles sold separately



SDP096

**3M** **E-A-R**

Model No.	Mfg. No.	Description	Price /Each
SDP096	391-0000	One Touch™ Pro Dispenser	124.00

### BULK REFILLS

Priced per Canister

Model No.	Mfg. No.	Description	NRR dB	Size	Pairs /Refill	Price /Each
SAP387	391-1001	Classic™	29	One Size	500	126.50
SAH873	391-1004	Yellow Neons™	33	Regular	500	94.75
SAH874	391-1005	Yellow Neons™	33	Large	400	96.50
SAI104	391-1010	Blasts™	33	Regular	500	143.25
SFU681	391-1012	E-A-Rsoft™	33	One Size	500	101.75
SFU682	391-1100	1100	29	One Size	500	96.00

## EARPLUGS TOUCHFREE ECOSTATION® DISPENSER STARTER KITS

- Automatic dispenser is more hygienic due to no-touch points
- Prevents workers from taking more than a pair at a time
- More economical and green than packaged earplugs
- Easy-to-install sealed refills snap in quickly
- Empty bottles are fully recyclable
- Gives workers easy access to hearing protection for more compliance
- High visibility to increase awareness for your hearing conservation program
- The sealed refill helps prevent contamination
- 100% PVC-free for a greener alternative



SGZ842



**MOLDEX**



Model No.	Mfg. No.	Description	Price /Each
SGZ842	6831	Softies® Earplugs Dispenser	245.00
SGZ843	6833	SparkPlugs® Earplugs Dispenser	261.00
SGZ844	6835	Pura-Fit® Earplugs Dispenser	284.00
SGZ845	6837	Meteors® Earplugs Dispenser	286.00

## PLUGSTATION® EARPLUG DISPENSERS

- Gives workers easy access to hearing protection
- Affordable enough to be placed near every work area
- Clicking mechanism for easier use and dispensing
- Chute delivers plugs right into the palm of your hand
- Each dispenser is sealed and disposable plus completely recyclable
- Mounting bracket with hardware included with every PlugStation®
- Certification(s): CSA Class AL



SE925

SE847

SGQ115



**MOLDEX**

Model No.	Mfg. No.	Description	NRR dB	Pairs /Dispenser	Price /Each
SE924	6644	SparkPlugs®, Uncorded	33	250	72.20
SE925	6645	SparkPlugs®, Uncorded	33	500	138.00
SDL452	6881	Metal Detectable SparkPlugs®, Corded	33	150	145.00
SDL453	6880	SparkPlugs®, Corded	33	150	90.90
SE847	6844	Pura-Fit®, Uncorded	33	250	86.10
SF624	6845	Pura-Fit®, Uncorded	33	500	166.00
SDL454	6882	Pura-Fit®, Corded	33	150	102.00
SAK439	6648	Camo Plugs®, Uncorded	33	500	148.00
SDS773	6883	Glide®, Corded	30	150	179.00
SGQ115	6868	Magnetic Bracket	-	-	32.00



# EARPLUGS

## AIR SOFT® EARPLUGS

- Advanced air pocket design features internal noise-blocking fins
- Four-flange rounded tapered profile creates better seal in the ear canal resulting in less pressure
- Firm stem facilitates easy insertion and removal
- Attenuation tested in accordance with ANSI S3.19-1974
- NRR 27 dB, CSA Class AL

Priced per box



**Honeywell**  
HOWARD LEIGHT

Model No.	Mfg. No.	Description	Qty/Box (Pairs)	Price /Each
<b>POLYBAGS</b>				
SD582	DPAS-1	Uncorded	100	148.00
SD583	DPAS-30R	Corded, Red Vinyl	100	193.00
SD584	DPAS-30W	Corded, White Nylon	100	193.00

## SMARTFIT® EARPLUGS

- Patented Conforming Material Technology™ uses body heat to adapt to the individual shape of each wearer's ear canal
- Delivers superior comfort and a truly individual fit
- Simplifies inventory control – a single product fits almost every wearer
- Detachable cord system and HearPack® storage case
- NRR 25 dB, CSA Class AL

Priced per box



**Honeywell**  
HOWARD LEIGHT

Model No.	Mfg. No.	Description	Qty/Box (Pairs)	Price /Each
SAK348	SMF-30	Corded	100	156.00

## TRUSTFIT™ POD PUSH-IN FOAM EARPLUG

- No roll-down foam reduces hygiene concerns and makes for easy insertion
- The ergonomically contoured paddle fits naturally between the finger and thumb, even while wearing work gloves
- Dimpled foam tip with ergonomic stem are easy to fully insert and remove
- Replace earplugs every 5 days, or if foam tip is not soft and pliable, if it is damaged or detached from stem
- NRR dB: 28
- Certification(s): CSA Class AL

Priced per box



**Honeywell**  
HOWARD LEIGHT

Model No.	Mfg. No.	Description	Qty/Box (Pairs)	Price /Each
SFQ516	TRUSTFITPOD-1	Uncorded	100	45.60

## FUSION® EARPLUGS

- Patented dual material design combines firm core for easy handling with soft flanges for comfort and fit
- FlexiFirm® stem is easy to grasp, ensuring easy insertion into the ear canal
- SoftFlange™ creates comfortable seal in the ear canal for superior comfort and protection
- Unique detachable nylon cord system adapts to virtually any application
- Two sizes fine-tune fit for personal comfort and safety
- NRR 27 dB, CSA Class AL

Priced per box

**Honeywell**  
HOWARD LEIGHT



Model No.	Mfg. No.	Description	Qty/Box (Pairs)	Price /Each
SAK349	FUS30-HP	Regular, HearPack™	100	209.00
SAK350	FUS30S-HP	Small, HearPack™	100	209.00

## QUIET® EARPLUGS

- Patented no-roll design is easy to handle and fit
- Contoured shape comfortably matches contours of the ear canal
- Smooth, non-irritating skin provides all-day comfort, easy to clean for long-term use
- Built-in insertion stem makes insertion quick and easy
- NRR 26 dB, CSA Class AL

Priced per box

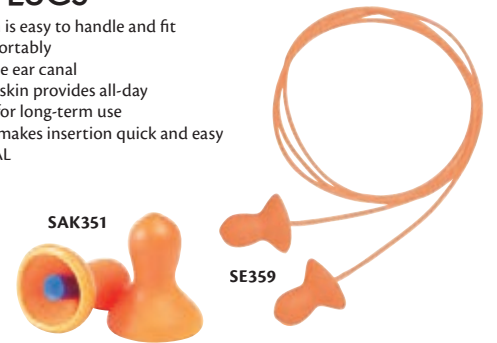

**Honeywell**  
HOWARD LEIGHT

Model No.	Mfg. No.	Description	Qty/Box (Pairs)	Price /Each
SAK351	QD1	Uncorded, Polybag	100	64.90
SE359	QD30	Poly Cord, Polybag	100	107.00

## ULTRAFIT™ EARPLUGS

- Patented triple flange design to fit a wide variety of ear canal sizes
- Washable, promotes worker hygiene
- Breakaway cord protects in case of machine entanglement
- NRR 25 dB, CSA Class AL

Priced per box



### MODEL SH113

- Metal detectable steel ball securely positioned in the stem and also a metal detectable cord to prevent earplugs from contaminating products or processes
- Non-food blue for visual detectability in the food processing industry

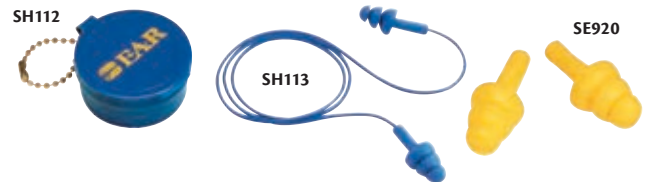

Model No.	Mfg. No.	Description	Qty/Box (Pairs)	Price /Each
<b>W/O CARRYING CASE</b>				
SE920	340-4003	Uncorded	100	167.00
SE405	340-4004	Corded	100	198.45
<b>METAL DETECTABLE</b>				
SH113	340-4007	Corded	100	215.26
<b>W/ CARRYING CASE</b>				
SH112	340-4002	Corded	50	3.40

## EXPRESS POD PLUGS EARPLUGS

### THE EASIEST EARPLUG TO USE!

- Quick, clean and hygienic
- Laboratory tested NRR 25 dB
- Reusable or disposable for cost-effective hearing protection
- Simple to clean and comes in a handy, resealable pack for easy storage
- Dispenser package in uncorded and corded blue grips or assorted colour grips (red, yellow, green, blue, purple) with matching cords
- Colour: Yellow
- CSA Class AL

Priced per box



SH118



SH116



Model No.	Mfg. No.	Description	NRR dB	Qty/Box (Pairs)	Price /Each
<b>UNCORDED</b>					
SH116	321-2100	Blue Grips	25	100	109.00
SH117	321-2200	Assorted Colour Grips	25	100	118.50
<b>CORDED</b>					
SH118	311-1114	Blue Grips	25	100	178.50
SH119	311-1115	Assorted Colour Grips	25	100	188.75

## ROCKETS® REUSABLE EARPLUGS

- Easy grip handle allows for easy insertion
- Air bubble in the tip provides cushioned comfort
- Can be washed and reused
- Each pair comes with a Pocket-Pak® carrying case to store plugs between uses
- Slips easily into the pocket
- NRR 27 dB, CSA Class AL

Priced per box



SAN318

SAN317



Model No.	Mfg. No.	Description	Qty/Box (Pairs)	Price /Each
SAN317	6400	Uncorded	50	121.00
SAN318	6405	Vinyl Corded	50	169.00

## ULTRAFIT™ REUSABLE EARPLUGS

- Innovative pistol grip shape designed to give wearers improved fingertip control
- Comfortable and reusable
- NRR 27 dB, CSA Class AL

Priced per box

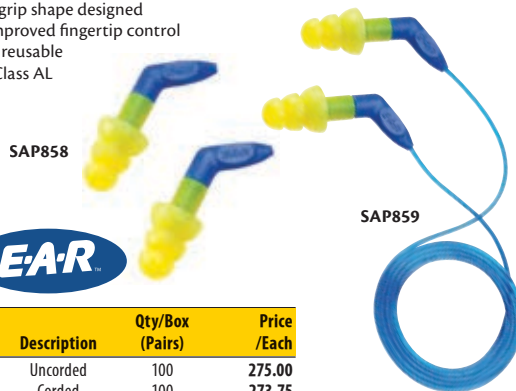

SAP858

SAP859



Model No.	Mfg. No.	Description	Qty/Box (Pairs)	Price /Each
SAP858	340-8001	Uncorded	100	275.00
SAP859	340-8002	Corded	100	273.75

## GLIDE® TRIO REUSABLE EARPLUGS

- Unique multi-curved stem rotates for a custom fit
- Large handle on curved stem for easy insertion & removal
- Soft triple flange plug can be washed and reused
- Cord can be attached at any desired length
- 100% PVC-free
- NRR 27 dB, CSA Class AL

Priced per box



Model No.	Mfg. No.	Qty/Box (Pairs)	Price /Each
SEH046	6445	50	107.00

## TRI-FLANGE REUSABLE EARPLUGS

- Customized comfort – reusable value
- Soft, pliable flanges conform to the shape of your ear canal for a custom fit
- Stem handle allows for quick, clean insertion
- Also available with a new cloth cord
- NRR 26 dB, CSA Class AL

Priced per box

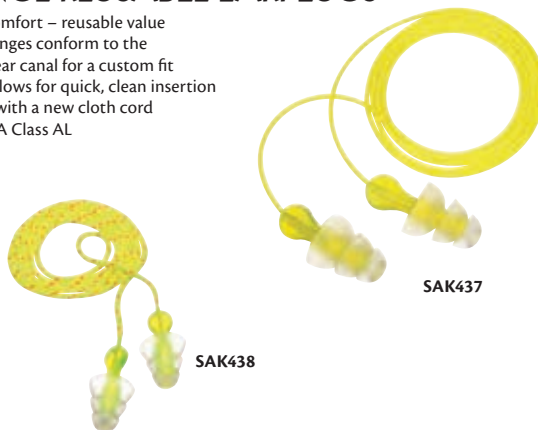

SAK437

SAK438



Model No.	Mfg. No.	Description	Qty/Box (Pairs)	Price /Each
SAK437	P3000	Corded	100	203.75
SAK438	P3001	With cloth cord	100	204.75



## JAZZ BAND® HEARING PROTECTORS

- Extra soft tapered foam pods gently conform to the ear canal
- Band pressure is reduced by 50%
- A cooler and lighter alternative to earmuffs
- 100% PVC-free
- Higher NRR 25 dB
- Includes an extra pair of pods



SE922

Model No.	Mfg. No.	Description	Price /Each
SE922	6506	Jazz Band® w/ cord and replacement pods	13.20
SE923	6504	Replacement pods, 5 pairs and 1 cord per bag	5.19

# EARPLUGS

## E-A-RFLEX HEARING BANDS

- Soft, E-A-Rform™ foam tips
- Pivoting tips for optimum fit
- Hi-Viz band
- Dermatologically safe plugs are non-irritating
- NRR 28 dB, CSA Class AL



Model No.	Mfg. No.	Description	Price /Each
SAK169	320-1000	Foam Tips	8.65

## CAPS® HEARING BANDS

- Non-invasive, comfortable hearing protection
- No hinged band
- Dermatologically safe plugs are non-irritating
- Band helps prevent loss and is ideal for intermittent use
- NRR 17 dB, CSA Class BL

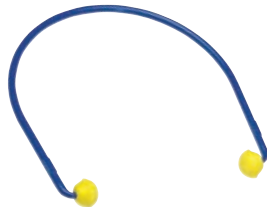

Model No.	Mfg. No.	Description	Price /Each
SR852	321-2101	Foam Caps	8.97
SH126	321-2103	Replacement Caps, 5 Pairs	25.40

## ELECTRONIC EARPLUGS

- Helps provide hearing protection
- Level-dependent function for situational awareness
- Intuitive one-button operation
- Rechargeable
- Durable storage and charging case
- Small and lightweight design
- Compatible with most head borne 3M Personal Protective Equipment
- Includes: (2) Earplugs, (1) Charging Case, (2) Large UltraFit Communication Tip Replacements, (2) Medium UltraFit Communication Tip Replacements, (2) Small UltraFit Communication Tip Replacements, (2) Peltor™ Triple C Communication Tips, (1) USB Cable, (1) User Instructions
- Style: Uncorded
- Certification(s): CSA Class AL
- Packaging: Pair - Plastic Case

Model No.	Mfg No.	Description	NRR dB	Price /Each
SGP577	EEP-100	Electronic Earplugs	23	338.04
SGP580	370-TEPS-25	UltraFit Communication Tip Replacements, Small	23	57.75
SGK976	370-TEPM-25	UltraFit Communication Tip Replacements, Medium	23	57.75
SGP578	370-TEPS-25	UltraFit Communication Tip Replacements, Large	23	64.16
SGK977	370-TEPL-25	Skull Screw™ Replacement Tips	32	35.80
SGP580	370-TEPS-25	Triple-C Communication Replacement Eartips	27	57.75

## EARPLUG BOX TRAYS

- Clear acrylic earplug dispenser tray holds a standard box of earplugs
- Front section catches spills and protects the corrugated dispenser
- Dimensions: 10 5/8" H x 10 5/8" W x 10 5/8" D
- Use on table top or wall mount

Model No. SED049  
Mfg. No. PD228E  
Price/Each \$128.99



## LARGE CAPACITY EARPLUG DISPENSERS

- Visually striking green glow front pocket draws attention to earplugs
- Dispenser features a removable inner slanted shelf to direct plugs toward pocket
- Comfortably holds a standard box of 200 disposable earplugs and can be wall or table mounted
- Dimensions: 13" H x 12" W x 8" D

Model No. SED051  
Mfg. No. PD439G  
Price/Each \$192.99



## PELTOR™ 3M

SGP577



Stay safe & work confidently with





## VERISHIELD™ 100 SERIES PASSIVE EARMUFFS

- Comfortably fits a wide range of head sizes
- Ideal for workers with larger ears, or who wear hearing aids
- Steel-wire construction with padded headband and precision micro adjustments
- Features a new unique memory foam that combines denser and softer foam than previous models
- Honeywell's Air Flow Control technology controls how sound reaches the ear, ensuring optimum noise attenuation across all frequencies



SGQ236



SGQ239



SGQ243

**Honeywell**  
HOWARD  
LEIGHT

Model No.	Mfg. No.	Attenuation Level	Colour	CSA Class	NRR dB	Price /Each
<b>HEADBAND</b>						
SGQ236	VS110	Low/Flat	Black	A	24	19.80
SGQ238	VS120	Mid	Black	A	26	33.30
SGQ240	VS130	High	Black	AL	30	44.40
SGQ241	VS130HV	High	High-Visibility Yellow	AL	30	44.30
<b>FOLDING HEADBAND</b>						
SGQ237	VS110F	Low/Flat	Black	A	24	33.20
SGQ239	VS120FHV	Mid	High-Visibility Yellow	AL	27	33.50
<b>NECKBAND</b>						
SGQ242	VS110N	Low/Flat	Black	B	22	19.00
SGQ243	VS120N	Mid	Black	AL	25	32.30
SGQ244	VS130N	High	Black	AL	28	40.70
<b>CAP MOUNT</b>						
SGQ245	VS110H	Low/Flat	Black	B	21	21.90
SGQ246	VS120H	Mid	Black	A	24	34.30
SGQ247	VS130H	High	Black	AL	27	44.40
SGQ248	VS130HHV	High	High-Visibility Yellow	AL	27	51.20

## VERISHIELD™ 100 SERIES DIELECTRIC PASSIVE EARMUFFS

- Comfortably fits a wide range of head sizes
- Wide cup opening is ideal for workers with large ears, or who wear hearing aids
- Lightweight cushioned headband
- Memory foam ear cushions
- Oil-resistant cup surface withstands oily, heavy-work environments and frequent cleaning
- Features Sound Management Technology (SMT) which improves employee safety by blocking harmful noise while allowing voices and signals to be heard more naturally
- Designed for use with other PPE



SGS322



SGS329



SGS325

**Honeywell**  
HOWARD  
LEIGHT

Model No.	Mfg. No.	Attenuation Level	Colour	CSA Class	NRR dB	Price /Each
<b>HEADBAND</b>						
SGS318	VS100D	Low/Flat	Black	B	20	21.10
SGS319	VS110D	Low/Flat	Black	A	23	19.40
SGS320	VS110FD	Low/Flat	Black	A	25	31.90
SGS321	VS120D	Mid	Black	A	26	33.00
SGS322	VS120DHV	Mid	High-Visibility Yellow	A	26	36.30
SGS323	VS130D	High	Black	AL	29	43.50
<b>CAP MOUNT</b>						
SGS325	VS110DH	Low/Flat	Black	A	23	19.40
SGS326	VS120DH	Mid	Black	A	25	33.90
SGS327	VS130DH	High	Black	AL	27	44.30
<b>MULTI-POSITION</b>						
SGS328	VS120M	Mid	Black	A	25	33.00
SGS329	VS130M	High	Black	AL	30	39.90

## IMPACT® SPORT EARMUFF

- Amplifies ambient sound to safe 82 dB
- Allows wearers to hear important communications, including environmental sounds
- Directionally-placed stereo microphones amplify and enhance sound for more natural hearing
- Low-profile design
- Features patented Air Flow Control technology
- Snap-in ear cushions make replacement quick and easy
- AUX input allows connection to external MP3 players or other audio devices
- CSA Class: B



**Honeywell**  
HOWARD  
LEIGHT

Model No.	Mfg. No.	Description	NRR dB	Price /Each
SGG272	1030942	Headband	22	128.00

## IMPACT® PRO INDUSTRIAL EARMUFFS

- Amplifies ambient sound to safe 82 dB - response technology revert to passive hearing protector when noise reaches 82 dB
- All-in-one up and down, on/off and volume control
- Non-deforming outer headband withstands rough treatment in the toughest workplaces
- Quick-Click height adjustment remains fixed during wear
- Sound amplification allows wearers to hear important communication -alarms/warning signals, co-workers' voices
- Snap-in ear cushions make replacement quick and easy
- Features 3.5mm audio jack and cable for connection to personal devices
- Hygiene kit available
- CSA Class: AL



**Honeywell**  
HOWARD  
LEIGHT

Model No.	Mfg. No.	Description	NRR dB	Price /Each
SFU874	1030943	Headband	30	270.00

# EARMUFFS

## QM24+ EARMUFF

- Soft foam cushions are easy to clean with soap and water, and can be replaced for extended use
- Ultra lightweight design. Weighing only 6 oz
- Alternative to cap-mounted earmuffs – wear with hard hats, face shields, respirators and other PPE
- Dielectric construction suitable for electrical environments
- Multiple-position headband allows wearer to select position over the head, behind the head or under the chin
- NRR dB: 25



**Honeywell**  
HOWARD  
LEIGHT

Model No.	Mfg. No.	Description	NRR dB	Price /Each
154-1205	QM24PLUS	Headband	25	15.20

## SYNC® RADIO HI-VISIBILITY EARMUFFS

- Limits sound radio volume to 82 dB
- Bright green ear cups and reflective headband provide high visibility
- Built-in AM/FM radio provides high sounds quality, excellent stereo reception
- AUX input jack for connection to MP3 players or other audio devices (includes 3.5 mm connection cable)
- Features patented Air Flow Control™ technology for optimal attenuation across all frequencies
- Snap-in ear cushion makes replacement quick and easy
- 140-hour battery life from 2 AA batteries (included)
- Hygiene kits available



**Honeywell**  
HOWARD  
LEIGHT

Model No.	Mfg. No.	Description	NRR dB	Price/Each
SEI616	1030390	Headband, Hi-Vis	25	136.00

## WIRELESS HEARING PROTECTOR EARMUFFS WITH BLUETOOTH® AUDIO

- Bluetooth® 4.1 connectivity allows you to keep your protective hearing earmuff on and your hands free while talking on the phone
- Streaming music wirelessly via Bluetooth® keeps your phone safe in your pocket and eliminates potentially dangerous cords
- Volume Management Technology limits output volume from portable audio devices to 82 dB
- Patented Air Flow Control Technology provides optimal noise reduction across all frequencies without increasing earcup size or weight
- Boom microphone outputs crystal clear audio while talking in noisy environments, and rotates easily out of the way when not in use
- The premium headband features a tough steel core for added durability and longer earmuff lifespan
- Earcups are cushioned and steel headband is padded for long-wearing comfort on the job
- Rechargeable battery lasts 16+ hours at highest usage i.e. active calling/streaming (often 20+ hours in first 1-2 years)
- USB charger with wall adapter
- 3.5 mm AUX cable



**Honeywell**

Model No.	Mfg. No.	Description	NRR dB	Price/Each
SGW722	RWS-53016	Headband	25	234.00

## MX-5 EARMUFF

- Soft cushion-ribbed open air headband for cool comfort all day long
- Larger ear cushions allow freedom to fit almost all ears comfortably
- Extra soft foam, low pressure cushions and headband are PVC-free
- Glossy surface for easy cleaning and longer wear
- CSA Class AL

SDK993



**MOLDEX**

Model No.	Mfg. No.	Description	NRR dB	Price /Each
SDK993	6120	Headband	27	52.40
SDK995	6125	Hygiene Kit	-	22.90

## MX-6 EARMUFF

- Soft cushion-ribbed open air headband for cool comfort all day long
- Larger ear cushions allow freedom to fit almost all ears comfortably
- Extra soft foam, low pressure cushions and headband are PVC-free
- Exclusive waffled cup foam for superior NRR protection
- CSA Class AL

SDK994



**MOLDEX**

Model No.	Mfg. No.	Description	NRR dB	Price /Each
SDK994	6130	Headband	30	64.70
SDK996	6135	Hygiene Kit	-	22.90

## MX-7 HIGH ATTENUATION EARMUFF

- Features Moldex exclusive waffled cup foam for superior NRR protection
- Larger ear cushions allow freedom to fit almost all ears comfortably
- Lightweight non-slip wire allows easy cup adjustment yet holds its position for lasting comfort
- Cool looks and comfort to promote worker acceptance and compliance
- Extra soft foam/low pressure cushions
- Glossy surface for easy cleaning and longer wear
- Easily slots into almost all hard hats



**MOLDEX**

Model No.	Mfg. No.	Description	NRR dB	Price/Each
SGL106	6140	Cap Mount	28	73.00

## OPTIMET™ 95 SERIES EARMUFFS

- Comfort engineered for continuous daily use
- Slim tapered dome for use with hardhat and face protection equipment
- Ultra light with liquid/foam filled ear cushions
- Exclusively engineered for the computer industry
- Also suitable for technical training schools, printing facilities, textile industries and home power equipment use
- CSA Class: B
- Colour: White

SAG847



SC175



SC177



SC176



**PELTOR™ 3M**

Model No.	Mfg. No.	Description	NRR dB	Wt. oz.	Price /Each
SC175	H6A/V	Headband	21	5.8	31.50
SC176	H6B/V	Neckband	21	5.3	31.50
SC177	H6P3E/V	Cap Mount	21	6.9	31.50
SAG847	H6F/V	Foldable	21	6.5	41.50

## OPTIMET™ 98 SERIES EARMUFFS

- Slim tapered upper dome, excellent for use with hard hat and face protection equipment
- Broad foam cushions give low, comfortable surface pressure
- Pressure equalization air openings, quickly ensure the correct pressure to the eardrum
- Suitable for factories, sheet metal works, schools, printing offices, textile industries and power equipment
- CSA Class A
- Colour: Yellow
- Hygiene kits available

SC172



**3M**

**PELTOR™**

Model No.	Mfg. No.	Description	NRR dB	Wt. oz.	Price /Each
SC172	H9A	Headband	25	5.1	32.00
SC173	H9P3E	Cap Mount	23	6.2	32.00

## OPTIMET™ 101 SERIES EARMUFFS

- Designed for maximum attenuation in a severe noise environment
- Soft sealing cushions easily replaceable by press-and-snap function
- Suitable for agriculture, construction equipment, heavy industry and airports
- CSA Class A
- Colour: Green
- Hygiene kits available

SC166



**3M**

**PELTOR™**

Model No.	Mfg. No.	Description	NRR dB	Wt. oz.	Price /Each
SC165	H7A	Headband	27	7.8	42.00
SC166	H7B	Neckband	26	7.2	42.00
SC167	H7P3E	Cap Mount	24	8.8	42.00

## OPTIMET™ 105 SERIES EARMUFFS

- Dual cup ultra high attenuating hearing protector for extremely high noise environments
- Wide ear cushions are filled with a foam which provides excellent sealing properties, good fit, and low surface pressure
- Ear cushions are easily replaceable with a simple press-and-snap function
- The outer layer consists of a specially developed hygienically textured plastic, allowing for ventilation and durability
- CSA Class AL
- Colour: Black with red trim
- Hygiene kits available

SC163



SC162



**PELTOR™ 3M**

Model No.	Mfg. No.	Description	NRR dB	Wt. oz.	Price /Each
SC161	H10A	Headband	30	9.3	53.00
SC162	H10B	Neckband	29	8.8	53.00
SC163	H10P3E	Cap Mount	27	10.4	53.00



# EARMUFFS

## X SERIES EARMUFFS

- The X-Series earmuffs are 3M's latest advancement in hearing conservation
- This low-profile earmuff is designed for protection against low-level industrial noise and other loud sounds
- Earcup pivot points tilt for optimum comfort and efficiency
- Hygiene kit available
- Compatible with WS-CUSH Peltor Wireless Bluetooth Communication accessory

SEJ034



SGC395

**3M**  
**PELTOR™**

Model No.	Mfg. No.	Description	CSA Class	NRR dB	Price/Each
SEJ034	X1A	Peltor™ X1, Over-Head Headband	A	22	27.50
SEJ035	X2A	Peltor™ X2, Over-Head Headband	A	24	30.50
SEJ036	X3A	Peltor™ X3, Over-Head Headband	AL	28	37.50
SEJ037	X4A	Peltor™ X4, Over-Head Headband	AL	27	45.50
SEJ038	X5A	Peltor™ X5, Over-Head Headband	AL	31	51.00
SGC394	X1P5E	Peltor™ X1P, Cap Mount	-	21	27.50
SGC395	X2P5E	Peltor™ X2P, Cap Mount	-	24	30.50
SGC396	X3P5E	Peltor™ X3P, Cap Mount	-	25	37.50
SGC397	X4P5E	Peltor™ X4P, Cap Mount	-	25	45.50
SGC398	X5P5E	Peltor™ X5P, Cap Mount	-	31	51.00

## E-A-RFIT™ DUAL-EAR VALIDATION SYSTEM

- Tests both ears simultaneously in under 5 seconds
- Earmuff and earplug testing capability
- Tests at 7 frequencies, from 125Hz to 8000Hz
- Science-based, objective, quantitative testing



**3M**

Model No.	Mfg. No.	Description	Price /Each
SDT137	393-1100	E-A-Rfit™ Dual-Ear Validation System	3428.00
SDT138	393-3001-2	X1/X2 Earmuffs Probed Test Cushions	44.00
SDT139	393-3003-2	X3 Earmuffs Probed Test Cushions	47.00
SDT140	393-3005-2	X4/X5 Earmuffs Probed Test Cushions	52.00

## TACTICALPRO™ TACTICAL 6 SLIM LINE HEADSET

### FOLDING INDUSTRIAL AND PROFESSIONAL SHOOTER ELECTRONIC AMBIENT LISTENING HEADSET

- When clear ambient sound and voice recognition is required in your noisy environment, rely on the latest line of electronic headsets from Peltor®
- Designed with a unique frequency response that amplifies signals, voices and warning sirens while at the same time instantaneously suppressing dangerous impulse noises
- Perfect choice for a wide variety of applications including: gun ranges, forklift drivers, airport ground personnel, maintenance mechanics and hearing-impaired workers
- Hygiene kits available
- Individual cup volume control
- Four AAA batteries for 200 hours of operation
- Colour: Grey



**3M**  
**PELTOR™**

Model No.	Mfg. No.	Description	CSA Class	NRR dB	Price/Each
SGL202	MT16H210F-479-SV	Headband	B	20	239.16

## PROTAC™ III HEADSET

- Environmental microphones for level-dependent hearing protection and ambient listening
- 3.5 mm listen-only stereo input for connection to external devices (e.g. cell phone, two-way radio, iPod)
- Voice-guided menu system for ease of use and adjusting settings
- Auto power off, the headset will turn off after 4 hrs of non-use to save battery
- Low-battery warning to inform you when to change batteries
- To reduce corrosion caused by sweat and moisture, the electronics are located in a separate compartment of the cup
- Occupational use only
- CSA Class: A



**3M**  
**PELTOR™**

Model No.	Mfg. No.	Description	NRR dB	Price /Each
SGL200	MT13H221A	Headband	26	154.20
SGL199	MT13H221P3E	Cap Mount	23	154.20
SGP582	MT13H221A	Hygiene Kit	-	24.86

## WORKTUNES™ PRO EARMUFFS

- Offers 10 AM/FM presets
- Integrated antenna (no snagging)
- Voice guided menu
- Lightweight
- Uses 3.5 mm jack for audio input
- Provides excellent reception with no interference, even in harsh conditions
- Comfortable for extended use, with soft cushions for low pressure
- 1 year warranty
- CSA Class: A



**3M**  
**PELTOR™**

Model No.	Mfg. No.	Description	NRR dB	Price /Each
SFV203	HRXS221A-NA	Headband	26	158.09

## SOUND LEVEL METER AND CALIBRATOR KIT

- Dual range measurement (Hi/Lo)
- A and C frequency weighting
- Large, easy-to-read LCD display
- Electret condenser microphone for high accuracy and longterm stability
- AC/DC output signal for use with dataloggers
- Data Hold, Max Hold functions and low battery indication
- Meets IEC651 Type 2 requirements
- Measuring range: Low: 35 to 100 dB; High: 65 to 135 dB (A and C)
- Operating Temperature: 32 to 104°F (0 to 40°C)
- Operating Humidity: 10-90%
- Includes carrying case and battery

**Model No. IB831**  
**Mfg. No. R8050-KIT**  
**Price/Each \$529.00**



**REED**

## SOUND LEVEL METER

- High accuracy of  $\pm 1.4$  dB meets Type 2 standards
- Triple range measurement (60dB dynamic range)
- Large, easy-to-read LCD display
- Data hold and Min/Max hold
- AC/DC output signal for use with data loggers
- Frequency Weighting: (MRAV2)
- Measuring Range: 30 - 90 dB|50 - 110 dB|70 - 130 dB
- Data Logging / Not Data Logging: Not Data Logging
- Measuring Range: 30-130dB
- Frequency Range: 20 Hz to 8 kHz
- Resolution: 0.1 dB (digital), 2dB (analog)
- Response Time: 500ms (digital), 100ms (analog)
- Power Supply: 9V battery

**Model No. HN404**  
**Mfg. No. R8060**  
**Price/Each \$259.00**

**REED**



## SOUND LEVEL METERS

- Measures sound levels in accordance with IEC61672 Class 2 Specifications:
- A/C frequency weighting
- Fast/slow time weighting
- Peak hold, data hold and max./min. record
- Real time data logger with integral SD memory card (optional)
- Measuring Range: 30 to 80 dB, 50 to 100 dB, 80 to 130 dB



**REED**

Model No.	Mfg. No.	Description	Price/Each
IC578	R8070SD	Sound Level Meter	429.00
IC494	RSD-ADP-NA	Power Adapter	39.00
IC495	RSD-16GB	16GB Memory Card	19.00
IB820	R1500	Tripod with Instrument Adapter	109.00

## SOUND CALIBRATORS

- Two outputs levels 94 dB and 114 dB (at 1 kHz)
- Diecasting aluminum alloy housing case
- Two 9 V batteries
- Size: 50 mm dia. x 82 mm

**Model No. IA661**  
**Mfg. No. R8090**  
**Price/Each \$249.00**



**REED**

## SOUND LEVEL METER/DATA LOGGERS

- Measuring Range: Low: 30 to 90 dB; Med: 50 to 110 dB; High: 70 to 130 dB Auto: 30 to 130 dB
- Dynamic Range: 60 dB • Accuracy:  $\pm 1.4$  dB
- Resolution: 0.1 dB
- Sample Rate: Digital: 0.5 sec. Analog: 50 mS
- Frequency Range: 20 Hz to 8 kHz
- Frequency Weighting: A and C
- Microphone: 1/2" electret condenser
- Power Supply: 4 x AAA batteries
- Meets IEC 61672-1 Class 2 requirements
- Records up to 64000 datapoints (1 MB)
- 60 dB dynamic space in each range
- Real time clock and calendar
- Fast/slow time weighting
- Min/Max function • USB Interface
- Analog digital bar graph • Backlit LCD display
- Tripod mount design for long-term monitoring
- Includes windscreen, USB cable, Windows software, batteries and hard carrying case



**REED**

Model No.	Mfg. No.	Description	Price/Each
IB749	R8080	Sound Level Meter/Data Logger	395.00

## SOUND LEVEL METERS

- Dual range measurement (Hi/Lo)
- A and C frequency weighting
- Large, easy-to-read LCD display
- Electret condenser microphone for high accuracy and longterm stability
- AC/DC output signal for use with dataloggers
- Data Hold, Max Hold functions and low battery indication
- Meets IEC651 Type 2 requirements
- Measuring range: Low: 35 to 100 dB; High: 65 to 135 dB (A and C)
- Operating Temperature: 32 to 104°F (0 to 40°C)
- Operating Humidity: 10-90%
- Includes carrying case and battery



**REED**

Model No.	Mfg. No.	Description	Price/Each
HX387	R8050	Sound Level Meter	195.00

# DISPOSABLE RESPIRATORS

## DISPOSABLE PROCEDURE FACE MASK

- Made in Canada
- Plastic with metal insert fitted nose piece and ear loops provide a custom fit
- 3 layers of breathable non-woven fabric
- Latex-free
- Dispenser-type packaging with a perforated opening tab
- Medical Device Class: Class 1
- Nose Clip Material: Plastic with Metal Insert



Model No.	Standard(s) Met	Price /Each
SGW395	ASTM F2100 Level 2	8.95
SGW904	ASTM F2100 Level 3	11.75

## DISPOSABLE NUISANCE DUST MASK

- Provides protection against nuisance dusts such as pollen, animal dander, saw dust, and other non-toxic dusts
- Lightweight construction and adjustable nose clip provides a secure fit
- Polypropylene filtering material
- Head Strap Material: Spandex
- Staples Material: Zinc Plated Iron
- Nose Clip Material: Aluminum



Model No.	Qty /Box	Price /Each
SGW858	50	7.55

## N95 PARTICULATE FLAT FOLD RESPIRATORS

- Low breathing resistance for increased wearer comfort
- Adjustable plastic nose clip and soft foam nosepiece provide a custom fit
- Medium/large
- Certification: NIOSH N95



Model No.	Description	Qty /Box	Price /Each
SDN711	Without valve	20	34.95
SDN712	With valve	12	29.95

## P100 PARTICULATE RESPIRATORS

- Contoured facial seal, fully adjustable head straps, and adjustable nose clip offer a comfortable secure fit
- Exhalation valve reduces hot air build up to facilitate breathing in humid environments
- Cup style
- Medium/Large
- Certification: NIOSH P100



Model No.	Description	Qty /Box	Price /Each
SDN714	With valve	5	49.95

## DISPOSABLE PROCEDURE FACE MASKS

- Made in Canada
- Plastic with metal insert fitted nose piece and ear loops provide a custom fit
- 3 layers of breathable non-woven fabric
- Latex-free
- Box of 50 with inner packs of 10 masks
- ASTM F2100 Level 2 as recommended by Health Canada
- Medical Device Class: Class 1
- Standard(s) Met: ASTM F2100 Level 2
- Sold/Priced Per: 5 Packs of 10

Model No. SGW447  
Price/Each \$13.25



## DISPOSABLE FACE MASKS

- 3-Ply construction
- Latex and graphene free
- Ear loops and metal nose bridge for easy adjustment
- Medical Device Class: Non-Medical



Model No.	Qty /Box	Price /Each
SGX679	50	4.75

## N100 PARTICULATE RESPIRATORS

- Contoured facial seal, fully adjustable head straps, and adjustable nose clip offer a comfortable secure fit
- Exhalation valve reduces hot air buildup to facilitate breathing in humid environments
- Cup style
- Medium/Large
- Certification: NIOSH N100



Model No.	Description	Qty /Box	Price /Each
SDN713	With valve	5	34.95

## N95 PARTICULATE RESPIRATORS

- Provides excellent worker protection
- Lightweight construction for enhanced comfort
- Adjustable nose clip with soft foam nose piece provides a secure fit
- Dual rubber strap design
- Latex free
- SAS498 comes with exhalation valve for reduced humidity build up
- NIOSH approved N95



Model No.	Description	Qty /Box	Price /Each
SAS497	Without valve	20	16.95
SAS498	With valve	12	13.95



## SAF-T-FIT® PLUS P1130 PARTICULATE RESPIRATORS

- Full face seal for a secure and comfortable fit
- Durable and adjustable straps
- Exhalation valve expels warm air
- Molded cup design
- Nose clip is colour-coded for visible size recognition
- Incorporates humidity-resistant filter media
- Low breathing resistance
- Lightweight design
- Latex free
- Packaged to maintain integrity of product in work environment
- NIOSH approved P100



**Honeywell**  
NORTH

Model No.	Mfg. No.	Size	Price /Each
SGE830	14110439	Small	13.10
SGE831	14110440	Medium/Large	13.20

## SAF-T-FIT® PLUS N1105 PARTICULATE RESPIRATORS

- Economical respiratory protection
- Lightweight, humidity resistant, hypoallergenic filter media
- Three colour-coded sizes for a better fit on a wider range of facial features
- NIOSH approved N95
- **20 respirators per box**



**Honeywell**  
NORTH

Model No.	Mfg. No.	Size	Price /Each
SAM235	14110387	Small	25.70
SAM236	14110388	Medium/Large	25.70
SAM237	14110389	X-Large	25.60

## SAF-T-FIT® PLUS N1115 PARTICULATE RESPIRATORS

- Lightweight, humidity resistant, hypoallergenic filter media
- Three colour-coded sizes for a better fit on a wider range of facial features
- Boomerang nose seal adapts to different faces for better protection
- NIOSH approved N95
- **20 respirators per box**



**Honeywell**  
NORTH

Model No.	Mfg. No.	Size	Price /Each
SAM238	14110390	Small	29.70
SAM239	14110391	Medium/Large	29.70
SAM240	14110392	X-Large	29.70

## SAF-T-FIT® PLUS N1125 OV PARTICULATE RESPIRATORS

- Lightweight, humidity resistant, hypoallergenic filter media
- Exhalation valve increases wearer comfort when working in hot environments
- Provides relief from nuisance level organic vapours
- Three colour-coded sizes for a better fit on a wider range of facial features
- Boomerang nose seal adapts to different faces for better protection
- NIOSH approved N95
- **10 respirators per box**



**Honeywell**  
NORTH

Model No.	Mfg. No.	Size	Price /Each
SAM244	14110396	Small	58.50
SAM245	14110397	Medium/Large	58.50
SAM246	14110398	X-Large	58.50

## DISPOSABLE RESPIRATOR

- Designed to fit most faces comfortably and accommodate the user's facial movements
- Multilayered absorption media with a smooth inner lining for added comfort
- Latex free, comfort stretch head straps
- Concealed, adjustable nose clip and soft foam nose cushion
- Humidity and moisture resistance filter media
- Use for solid particulates & nonpetroleum based liquid aerosols
- Comfort stretch, cloth strap
- Open cell nose foam
- Meets OSHA Respiratory Protection Standard 29 CFR 1910.134
- Not tested against COVID-19 or other pathogens
- Certification(s): NIOSH
- Size: One Size
- Style: Flat Fold
- Exhalation Valve: Without
- Type: N95
- Strap Style: Welded
- Strap Material: Cloth
- Weight: 0.2 oz.
- OSHA Protection Factor: APF 10
- Sold/Priced Per: Box of 50



**Model No. SGZ853**  
**Mfg. No. DF300N95B**  
**Price/Each \$86.30**

**Honeywell**  
NORTH

## NUISANCE DUST MASKS

- Suitable for nuisance dusts such as animal dander or pollen
- This mask is not NIOSH approved
- **50 masks per box**



Model No.	Mfg. No.	Price /Each
SAM286	14110094CC	10.30

**Honeywell**  
NORTH

## SAF-T-FIT® PLUS P1135 PARTICULATE RESPIRATORS

- Lightweight, humidity resistant, hypoallergenic filter media
- Exhalation valve increases wearer comfort when working in hot environments
- Three colour-coded sizes for a better fit on a wider range of facial features
- Full sealing flange maximizes protection and wearer comfort
- NIOSH approved P95
- **10 respirators per box**



Model No.	Mfg. No.	Size	Price /Each
SAM255	14110428	Medium/Large	46.50
SAM256	14110429	X-Large	46.50

**Honeywell**  
NORTH

## SAF-T-FIT® PLUS N1139 PARTICULATE RESPIRATORS

- Lightweight, humidity resistant, hypoallergenic filter media
- Exhalation valve increases wearer comfort when working in hot environments
- Three colour-coded sizes for a better fit on a wider range of facial features
- Full sealing flange maximizes protection and wearer comfort
- NIOSH approved N99
- **10 respirators per box**



Model No.	Mfg. No.	Size	Price /Each
SAM250	14110402	Small	46.30
SAM251	14110403	Medium/Large	46.30
SAM252	14110404	X-Large	46.30

**Honeywell**  
NORTH

# DISPOSABLE RESPIRATORS

## 8110S & 8210 N95 PARTICULATE RESPIRATORS



- NIOSH approved for at least 95 percent filtration efficiency against certain non-oil based particles
- Lightweight construction promotes greater worker acceptance and may help increase wear time
- Adjustable nose clip and cushioning nose foam provide a custom fit and reduce fogging
- Advanced electrostatic microfibre filter media is designed for ease of breathing
- Two-strap design with welded dual point attachment helps provide a secure seal
- Can also be used to help reduce inhalation of certain airborne biological particles like mould, Bacillus Anthracis, Mycobacterium Tuberculosis, etc.
- **20 respirators per box**



Model No.	Mfg. No.	Size	Price /Each
SAM402	8110S	Small	31.42
SE260	8210	Regular	29.78

## 8210V N95 PARTICULATE RESPIRATORS

- Excellent worker protection
- Proprietary filter media helps make breathing easier
- 3M™ Cool Flow™ Exhalation Valve reduces heat build up inside the respirator
- Lightweight construction
- Adjustable nose clip and cushioning nose foam provide a custom fit an reduce fogging
- NIOSH approved N95
- **10 respirators per box**



Model No.	Mfg. No.	Price /Each
SEF203	8210V	23.13

## 8200 N95 PARTICULATE RESPIRATORS

- Proprietary filter media helps make breathing easier
- Lightweight construction enhances comfort and wear time
- Two-strap design with dual point attachment for secure fit
- Adjustable nose clip
- NIOSH approved N95
- **20 respirators per box**



Model No.	Mfg. No.	Price /Each
SAQ777	8200	21.24

## 8233 N100 PARTICULATE RESPIRATORS

- Proprietary filter media helps make breathing easier
- 3M™ Cool Flow™ Exhalation Valve reduces heat build-up inside the respirator
- Adjustable nose clip
- Lightweight construction
- Comfortable foam face seal
- Adjustable straps
- NIOSH approved N100
- **1 respirator per bag**



Model No.	Mfg. No.	Price /Each
SE268	8233	16.18

## 8511 N95 PARTICULATE RESPIRATORS



- Proprietary filter media helps make breathing easier
- 3M™ Cool Flow™ Exhalation Valve reduces heat build up inside the respirator
- Adjustable M-nose clip allows fewer pressure points and greater comfort
- Braided comfort straps
- Lightweight construction
- NIOSH approved N95
- **10 respirators per box**



Model No.	Mfg. No.	Price /Each
SE261	8511N95	33.54

## 9105 & 9105S N95 VFLEX™ PARTICULATE RESPIRATORS



- V-shaped pleats flex with mouth movement for easier talking and expand to help ease of breathing
- Uniquely designed tabs help position the respirator on the face
- Adjustable nose clip provides a custom fit and secure seal
- Elastic headband
- Model SED599 fits small faces
- NIOSH approved N95
- **50 respirators per box**



Model No.	Mfg. No.	Size	Price /Each
SED599	9105S	Small	47.28
SED600	9105	Regular	47.28

## 9210+ N95 AURA™ PARTICULATE RESPIRATORS



- Three-panel respirator
- Soft, comfortable nose clip
- Lightweight, collapse-resistant design
- NIOSH approved N95
- Certification(s): NIOSH
- Size: Standard
- Style: Flat Fold
- Exhalation Valve: Without
- **20 respirators per box**



Model No.	Mfg. No.	Price /Each
SEJ983	9210-PLUS	36.47

## 9211+ N95 AURA™ PARTICULATE RESPIRATORS



- Three-panel respirator
- Soft, conformable nose clip
- Lightweight, collapse-resistant design
- With 3M™ Cool Flow™ Exhalation Valve
- Certification(s): NIOSH
- Size: Standard
- Style: Flat Fold
- **10 respirators per box**



Model No.	Mfg. No.	Price /Each
SR616	9211+	30.70

# DISPOSABLE RESPIRATORS

## 8212 & 8214 N95 WELDING PARTICULATE RESPIRATORS



- 3M™ Cool Flow™ Exhalation Valve reduces heat build up inside the respirator
- Cake resistant filter media provides longer respirator life and is designed for ease of breathing
- Fits easily under a welding hood
- Adjustable straps
- Comfortable foam face seal
- Flame resistant as per ASTM D2859-96 testing
- NIOSH approved N95
- **10 respirators per box**



Model No.	Mfg. No.	Description	Price /Each
SE262	8212	N95	109.61
SE883	8214	N95 w/Nuisance Level Organic Vapour Relief	129.81

## 8515 N95 WELDING PARTICULATE RESPIRATORS



- Proprietary filter media helps make breathing easier
- 3M™ Cool Flow™ Exhalation Valve reduces heat build-up inside the respirator
- Adjustable M-nose clip allows fewer pressure points and greater comfort
- Lightweight construction
- Braided comfort straps
- NIOSH approved N95
- **10 respirators per box**



Model No.	Mfg. No.	Price /Each
SA0788	8515	51.16

## AURA™ PARTICULATE RESPIRATORS 9205+

- Lightweight, three-panel design
- Filters dust and other particles, while allowing for easy breathing
- The soft inner material provides added comfort while the soft nose foam and adjustable nose clip help provide a custom seal
- Sculpted nose panel that follows the contours of your nose allowing more room for eyewear
- Embossed top panel designed to help reduce the fogging of eyewear
- Innovative chin tab designed for ease of positioning, donning, and adjustment
- Can also be used to help reduce inhalation of certain airborne biological particles
- Example applications include emergency or pandemic preparedness planning, stockpiling, etc.
- Individual packaging
- Certifications: NIOSH
- Size: Standard
- Style: Flat Fold
- Exhalation Valve: Without
- Type: N95
- Colour: White



Model No.	Mfg. No.	Sold/Priced Per	Price /Each
SHF155	9205+	Box of 20	38.02
SGW584	9205+BULK	Case of 440	774.40

## 8246 & 8247 R95 PARTICULATE RESPIRATORS

- Proprietary filter media helps make breathing easier
- Adjustable nose clip and cushioning nose foam provide a custom fit and reduce fogging
- Lightweight construction
- NIOSH approved R95
- **20 respirators per box**



Model No.	Mfg. No.	Description	Price /Each
SE263	8246	R95 w/Nuisance Level Acid Gas Relief	118.95
SE264	8247	R95 w/Nuisance Level Organic Vapour Relief	131.30

## 8271, 8576 & 8577 P95 PARTICULATE RESPIRATORS

- Proprietary filter media helps make breathing easier
- 3M™ Cool Flow™ Exhalation Valve reduces heat build-up inside the respirator
- Adjustable M-nose clip allows fewer pressure points and greater comfort
- Lightweight construction
- Braided comfort straps
- NIOSH approved P95
- **10 respirators per box**



Model No.	Mfg. No.	Description	Price /Each
SE267	8271	P95	57.14
SE265	8576	P95 w/ Nuisance Level Acid Gas Relief	77.22
SE266	8577	P95 w/ Nuisance Level Organic Vapour Relief	81.70

## AURA™ HEALTH CARE PARTICULATE RESPIRATORS & SURGICAL MASKS 1870+

- Offers > 99% BFE (Bacterial Filtration Efficiency) according to ASTM F2101
- Embossed top panel helps reduce eyewear fogging
- Meets CDC guidelines for M. tuberculosis exposure control
- Reduces wearer exposure to certain airborne particles including those generated by electrocautery, laser surgery, and other powered medical instruments
- Designed to be fluid-resistant to splash and spatter of blood and other infectious materials
- Individual packaging
- Certifications: NIOSH
- Size: Standard
- Style: Flat Fold
- Exhalation Valve: Without
- Type: N95
- Colour: White



Model No.	Mfg. No.	Sold/Priced Per	Price /Each
SHF154	1870+	Box of 20	42.37
SGW636	1870+BULK	Case of 440	862.40

## 8293 P100 PARTICULATE RESPIRATORS

- Lightweight construction
- Proprietary filter media helps make breathing easier
- 3M™ Cool Flow™ Exhalation Valve reduces heat build up inside the respirator
- Comfortable foam face seal
- Adjustable straps
- NIOSH approved P100
- **1 respirator per bag**



Model No.	Mfg. No.	Price /Each
142-8293	8293	19.72

## RESPIRATORS DISPENSER

- Convenient clear acrylic dispenser has a unique cut-out design that allows you to reach in the opening to easily remove even the last respirator
- Fits any disposable respirator model
- Holds more than 30 respirators
- Dimensions: 6" W x 6" D x 12 1/2" H

Model No. SAM878  
Mfg. No. M420  
Price/Each \$158.99

Respirators sold separately





# DISPOSABLE RESPIRATORS

## 2200 N95 PARTICULATE RESPIRATORS

- Dura-Mesh® shell resists collapsing
- Molded nose bridge seals easily without a metal nose band
- Flame retardants are added to the shell to help decrease flammability
- NIOSH approved N95
- **20 respirators per box**



Model No.	Mfg. No.	Description	Colour	Price /Each
SE451	2200N95	Medium/Large	White	43.70
SE452	2201N95	Small	White	43.70
SE848	2207N95	Low Profile	White	43.70

## 2400 N95 PARTICULATE RESPIRATORS

- Added carbon layer helps filter out nuisance levels of ozone and organic vapours (less than OSHA PEL)
- Exhale valve reduces hot air build-up
- Dura-Mesh® shell resists collapsing
- Contour molded nose bridge with soft foam nose cushion provides all-day comfort
- Meets heat and flame resistance in accordance with ANSI/ISEA 110-2009 section 7.11.1
- NIOSH approved N95
- **10 respirators per bag**



Model No.	Mfg. No.	Description	Price /Each
SE852	2400N95	Medium/Large	95.80

## 2300 N95 PARTICULATE RESPIRATORS

- Exhale valve reduces hot air build up
- Dura-Mesh® shell resists collapsing
- Molded nose bridge seals easily without a metal nose band
- Soft foam nose cushion
- Available in three sizes to fit most faces
- NIOSH approved N95
- **10 respirators per box**



Model No.	Mfg. No.	Description	Price /Each
SE849	2300N95	Medium/Large	54.40
SE850	2301N95	Small	54.40
SE851	2307N95	Low Profile	54.40

## 2500 N95 PARTICULATE RESPIRATORS

- Added carbon layer helps to filter nuisance levels of acid gas irritants (less than OSHA PEL)
- Exhale valve reduces hot air build-up
- Dura-Mesh® shell resists collapsing
- Contour molded nose bridge with soft foam nose cushion provides all-day comfort
- Meets heat and flame resistance in accordance with ANSI/ISEA 110-2009 section 7.11.1
- NIOSH approved N95
- **10 respirators per bag**



Model No.	Mfg. No.	Description	Price /Each
SE853	2500N95	Medium/Large	99.30

## 2700 N95 PARTICULATE RESPIRATORS

- HandyStrap® with buckle allows the respirator to hang down around neck when not in use
- Cloth strap feels cool and comfortable against the skin
- Ventex® valve lets the hot air out faster
- Soft foam nose cushion
- Dura-Mesh® shell resists collapsing
- NIOSH approved N95
- **10 respirators per box**



Model No.	Mfg. No.	Description	Price /Each
SJ902	2700N95	Medium/Large	68.70

## 2800 N95 PARTICULATE RESPIRATORS

- Added carbon layer helps filter out nuisance levels of ozone and organic vapours (less than OSHA PEL)
- HandyStrap® cloth strap feels cool and comfortable against the skin
- Ventex® valve lets the hot air out faster
- Dura-Mesh® shell resists collapsing
- Contour molded nose bridge with soft foam nose cushion provides all-day comfort
- Meets heat and flame resistance in accordance with ANSI/ISEA 110-2009 section 7.11.1
- NIOSH approved N95
- **10 respirators per box**



Model No.	Mfg. No.	Description	Price /Each
SJ904	2800N95	Medium/Large	106.00

## AIRWAVE™ RESPIRATORS

- Exclusive easy-breathing wave design
- FlexFit™ comfort wave flexes with you
- Dura-Mesh® shell adds lasting durability

### N95 RESPIRATORS

- Less resistance, better breathability
- Cool inside, without a valve
- Ideal where unvalved respirators are preferred
- **10 respirators per box**

### N100 RESPIRATORS

- 99.97% efficient against non-oil based particulates
- FlexFit design moves easily with your face and stays in place
- Dura-Mesh® shell resists collapsing in heat and humidity
- Ventex® valve lets the hot air out faster so workers breathe easier and stay cooler
- Foam face cushion for added comfort and no pressure points
- Softspun® lining for increased comfort and durability
- Meets heat and flame resistance in accordance with ANSI/ISEA 110-2009 Section 7.11.1
- Metal-free
- **5 respirators per box**



Model No.	Mfg. No.	Description	Straps	Certification	Price /Each
<b>N95</b>					
SEI529	4600N95	Medium/Large	Adjustable*	NIOSH N95	55.40
SEI530	4601N95	Small	Adjustable*	NIOSH N95	55.40
<b>N100</b>					
SDL006	4700N100	Medium/Large	Adjustable*	NIOSH N100	102.00

\*SmartStrap® allows the Airwave to hang from neck when not in use

## M SERIES AIRWAVE DISPOSABLE RESPIRATORS

- Exclusive easy-breathing wave design
- Available in two sizes to fit more workers and facilitate OSHA compliance
- Less resistance, better breathability
- Can be used against most welding fumes
- FlexFit® design moves easily with your face and stays in place
- Dura-Mesh shell resists collapsing in heat and humidity
- Soft, cloth SmartStrap is both hangable and adjustable
- Meets heat and flame resistance in accordance with ANSI/ISEA 110-2009 Section 7.11.1
- Metal-free and 100% PVC-Free for a greener alternative
- Style: Cup
- Exhalation Valve: Without
- Type: N95
- Colour: Black



Model No.	Mfg. No.	Size	Price /Each
<b>WITH NOSE FLANGE</b>			
SHB888	M4600	Medium/Large	68.00
SHB889	M4601	Small	68.00
<b>WITH FOAM FLANGE</b>			
SHB890	M4620	Medium/Large	74.30
SHB891	M4621	Small	74.30

## 2310/2315 N99 PARTICULATE RESPIRATORS

- Exhale valve reduces hot air build up
- Dura-Mesh® shell resists collapsing
- Contour molded nose bridge and soft foam nose cushion
- Meets heat and flame resistance in accordance with ANSI/ISEA 110-2009 section 7.11.1
- NIOSH approved N99
- **10 respirators per bag**



Model No.	Mfg. No.	Description	Price /Each
SE854	2310N99	Standard Straps	97.20

## 2740 R95 PARTICULATE RESPIRATORS

- Handystrap® with buckle
- Ventex® valve lets the hot air out faster
- Soft foam nose cushion
- Dura-Mesh® shell resists collapsing
- Flame retardants are added to the shell to help decrease flammability
- Meets heat and flame resistance in accordance with ANSI/ISEA 110-2009 section 7.11.1
- NIOSH approved R95
- **10 respirators per box**

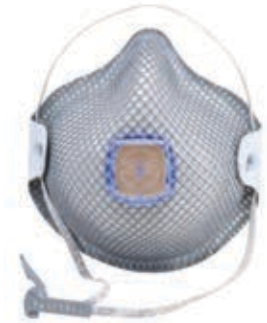

Model No.	Mfg. No.	Description	Price /Each
SAF825	2740R95	Medium/Large	79.80

## SPECIAL OPST™ SERIES PARTICULATE RESPIRATORS

- Solid black colour stays cleaner looking longer to prevent premature disposal
- HandyStrap® with buckle
- Stretch cloth strap feels cool and comfortable against the skin
- Contoured nose bridge with soft foam nose cushion
- NIOSH approved N95 or R95



Model No.	Mfg. No.	Size	Type	Qty /Box	Price /Each
SAM858	M2600N95	Medium/Large	N95	15	46.80
<b>RESPIRATORS WITH VENTEX® VALVE</b>					
SAM860	M2700N95	Medium/Large	N95	10	74.20
SAM862	M2740R95	Medium/Large	R95	10	84.20

# REUSABLE RESPIRATORS

## P95 PAINT SPRAY/PESTICIDE HALF FACEPIECE DISPOSABLE RESPIRATORS

- NIOSH approved for respiratory protection against certain organic vapours and particulates
- Pre-assembled with permanently attached cartridges
- Lightweight well-balanced design enhances comfort
- Disposable model helps reduce maintenance issues for greater convenience
- Packaged with one pair of P95 prefilters and one pair of prefilter retainers



**3M**

Model No.	Mfg. No.	Size	Price /Each
SE884	51P71	Small	45.88
SE406	52P71	Medium	44.98
SE885	53P71	Large	45.88

## ORGANIC VAPOUR/ACID GAS RESPIRATORS

- Pre-assembled so there are no spare parts to replace
- Cradle suspension holds the respirator in place with minimal pressure to the back of the neck and the bridge of the nose
- Low profile organic vapour cartridges for a wider field of vision and greater comfort while wearing glasses or goggles
- NIOSH approved
- Organic Vapour/Acid Gas



**3M**

Model No.	Mfg. No.	Size	Price /Each
S1940	5103	Small	34.95
S1941	5203	Medium	34.95
S1942	5303	Large	34.95

## 6000 SERIES HALF FACEPIECE REUSABLE RESPIRATOR

- Respirator combines comfort and convenience with easy-to-adjust, soft head straps
- Low profile respirator design does not interfere with wearing safety glasses
- Can be disassembled, cleaned and reused
- Replaceable cartridges and filters available
- Includes: reclosable storage bag
- Recommended industries include: construction, manufacturing, industrial maintenance, marine, mining, oil & gas transportation
- Suggested applications: chemical clean-up and handling, chipping, chiseling and cleaning
- Standards: NIOSH approved



**3M**

Model No.	Mfg. No.	Size	Price /Each
SE886	6100	Small	22.05
SE887	6200	Medium	22.05
SE888	6300	Large	22.05

### REPLACEMENTS PARTS

Model No.	Mfg. No.	Description	Qty /Pkg.	Price /Each
SR188	6893	Inhalation Valves	40	91.78
SA1579	6889	Exhalation Valves	10	67.50
SA1583	6281	Head Harness	5	85.67
SR190	6895	Inhalation Gaskets	20	43.04

## 6500 SERIES HALF FACEPIECE RESPIRATORS

- Provides comfort and stability with a soft but firm silicone facesal
- Resilient material extends product life
- Maintains its shape in high heat environments
- Overmolded, low-profile design simplifies cleaning and maintenance with fewer parts and crevices, and provides a wide field of view
- Valve cover design directs exhaled breath and moisture downwards, and facilitates a positive pressure seal check
- 3M™ Cool Flow™ Exhalation Valve enhances comfort by reducing heat and moisture, and allows for easier breathing
- Adjustable head harness assembly provides optimum fit and comfort with a three-size adjustable head cradle
- Optional quick latch drop-down mechanism allows for easy on and off as workers move in and out of contaminated areas – no need to remove your hard hat, eyewear or faceshield
- NIOSH approved



**3M**

Model No.	Mfg. No.	Size	Price /Each
SEJ779	6501	Small	36.89
SEJ780	6502	Medium	36.89
SEJ781	6503	Large	36.89

### W/QUICK LATCH DROP-DOWN FEATURE

SEJ782	6501QL	Small	38.73
SEJ783	6502QL	Medium	38.73
SEJ784	6503QL	Large	38.73



## 7500 SERIES REUSABLE HALF FACEPIECE RESPIRATORS



- Advanced silicone material provides a softer feel on the face
- Unique adjustment design helps reduce pressure points on the face
- Dual-mode head harness, option of wearing in traditional or drop-down mode
- 3M™ Cool Flow™ Exhalation Valve helps reduce heat and moisture build-up for easier breathing
- NIOSH approved



Model No.	Mfg. No.	Size	Price /Each
SAG264	7501	Small	52.38
SAG265	7502	Medium	52.38
SAG266	7503	Large	52.38

### REPLACEMENT PARTS

Model No.	Mfg. No.	Description	Qty /Pkg.	Price /Each
SAI636	7582	Inhalation Valves	10	68.49
SAI635	7581	Head Harness	5	108.55
SAI638	7586	Cartridge Filter Holders	5	57.11

## 6000 SERIES FULL FACEPIECE RESPIRATORS

- Lightweight, well balanced, low maintenance facepiece provides user comfort, convenience, and ease of breathing
- Unique centre adapter directs exhaled breath and moisture downward
- Smooth surfaces allow for quick and easy cleaning
- 3M™ Cool Flow™ Exhalation Valve reduces heat and moisture build-up inside the facepiece, making breathing easier and providing cool, dry comfort
- Wide field of vision provides excellent visibility
- NIOSH approved



Model No.	Mfg. No.	Size	Price /Each
SE889	6700	Small	269.76
SE890	6800	Medium	269.76
SE891	6900	Large	269.76

### ACCESSORIES

Model No.	Mfg. No.	Description	Qty /Pkg.	Price /Each
SI946	6885	Clear Lens Covers	25	81.47
SI947	6886	Tinted Lens Covers	25	200.19

### REPLACEMENT PARTS

Model No.	Mfg. No.	Description	Qty /Pkg.	Price /Each
SAI579	6889	Exhalation Valves	10	67.50
SAN499	6864/37000	Centre Adapter Assembly	1	146.20
SR188	6893	Inhalation Valves	40	91.78
SAI581	6894	Nosecup Assembly	1	60.04
SR190	6895	Inhalation Gaskets	20	43.04
SR189	6897	Head Harness Assembly	1	48.53
SAI584	6898	Lens Assembly	1	152.93
SAI585	6899	Lens Frame Kit	1	60.18

## 7800S SERIES FULL FACEPIECE RESPIRATORS

- Silicone facepiece
- Versatile - use with particulate filters, gas/vapour cartridges, supplied air systems or Powered Air Purifying Respirators (PAPR)
- Double-flange face seal
- 3M™ Cool Flow™ Exhalation Valve helps make breathing easier
- Speaking diaphragm for easy, clear communications
- Scratch-resistant polycarbonate lens
- Six adjustable straps
- NIOSH approved



SG535



Model No.	Mfg. No.	Size	Price /Each
SG534	7800S(S)	Small	736.39
SG535	7800S(M)	Medium	736.39
SG536	7800S(L)	Large	736.39

### REPLACEMENT PARTS

Model No.	Mfg. No.	Description	Qty /Pkg.	Price /Each
SAI640	7282	Inhalation Valves	50	185.19
SAI641	7283	Exhalation Valves	10	89.28
SAI639	701	Cartridge Filter Adapters	2	24.61
SR190	6895	Inhalation Gaskets	20	43.04
SAI642	7884	Lens	1	150.75
SAI643	7885	Frame Kit for Lens	1	113.98
SAI644	7887	Gaskets for Inhalation Valves	2	22.89
SAF820	7893S	Head Strap Assembly	1	187.56

### ACCESSORIES

Model No.	Mfg. No.	Description	Qty /Pkg.	Price /Each
SAI645	7894	Spectacle Kit	1	367.50
SI948	7899-25	Clear Lens Covers	25	116.42
SI949	7986	Tinted Lens Covers	25	209.96
SDS605	7990	Clip-On Welding Adapter	1	366.75

## ULTIMATE FX FF-400 SERIES FULL FACEPIECE RESPIRATORS

- Engineered for maximum comfort, durability, and visibility
- Provides rugged flexibility in extreme environments while still delivering superior comfort
- The only respirator with Scotchgard™ Protector for easier cleaning and maintenance
- Passive speaking diaphragm for easier communication
- 3M™ Cool Flow™ Exhalation Valve for easier breathing and cool, dry comfort
- Features soft yet durable silicone faceseal and head harness
- Long-lasting head harness – straps pulled over one million times in durability testing
- Large lens for superior peripheral vision
- Low profile bayonet cartridge attachments, designed for improved balance and better weight distribution
- Six strap head harness with comfort cradle
- NIOSH approved



SEB184













Model No.	Mfg. No.	Size	Price /Each
SEB184	FF-401	Small	388.25
SEB185	FF-402	Medium	388.25
SEB186	FF-403	Large	388.25

Model No.	Mfg. No.	Description	Qty/Pkg.	Price /Each
SDS857	FF-400-15	Standard Lens Covers	25	80.88
SDP319	FF-400-17	Semi-Permanent Lens Cover	5	74.06
SDP385	FF-400-25	Nylon Storage Bag	1	21.58

# REUSABLE RESPIRATORS







## MULTI-GAS/VAPOUR CARTRIDGES 6000 SERIES



Cartridges	Description	Approved For	Model No.	Mfg. No.	Qty /Pkg.	Price /Each
	Organic Vapours	Organic Vapours	SE892	6001	2	20.36
	Acid Gas	Chlorine/Hydrogen Chloride/ Sulfur Dioxide/Chlorine Dioxide/ Hydrogen Sulfide	SE893	6002	2	21.67
	Organic Vapours/ Acid Gas	Organic Vapours/Chlorine/Hydrogen Chloride/Sulfur Dioxide/Hydrogen Fluoride/Hydrogen Sulfide	SE894	6003	2	22.00
	Ammonia/ Methylamine	Ammonia/Methylamine	SE895	6004	2	25.08
	Formaldehyde	Formaldehyde and certain organic vapours	SE896	6005	2	25.34
	Multi-Gas/ Vapour	Organic Vapours/Chlorine/Chlorine Dioxide/ Hydrogen Chloride/Sulfur Dioxide/ Hydrogen Fluoride/Hydrogen Sulfide/ Ammonia/Methylamine/Formaldehyde	SE897	6006	2	22.42
	P95 Prefilter	Use with 6000 series cartridges or SEH649 prefilter adapter	SE914	5P71	10	34.66
	N95 Prefilter	Use with 6000 series cartridges or SEH649 prefilter adapter	SE913	5N11	10	27.83
	Prefilter Retainer	For use with SE913 or SE914	SE915	501	1	3.69
	Prefilter Adapter	For use with SE913 or SE914	SEH649	603	2	9.00

## ORGANIC VAPOUR CARTRIDGES, P100









Cartridges	Description	NIOSH Approved For	Model No.	Mfg. No.	Qty /Pkg.	Price /Each
	Organic Vapours/ P100	Organic Vapours with P100 particulate filter*	SE899	60921	2	44.50
	Acid Gas/P100	Chlorine/Hydrogen Chloride/Sulfur Dioxide/Chlorine Dioxide/Hydrogen Sulfide with P100 particulate filter*	SE900	60922	2	45.83
	Organic Vapour/ Acid Gas/P100	Organic Vapours/Chlorine/Hydrogen Chloride/Sulfur Dioxide/Hydrogen Fluoride/Hydrogen Sulfide with P100 particulate filter*	SE901	60923	2	45.66
	Ammonia/ Methylamine/ P100	Ammonia/Methylamine with P100 particulate filter*	SE902	60924	2	49.15
	Formaldehyde/ P100	Formaldehyde and certain organic vapours with P100 particulate filter*	SE903	60925	2	50.19
	Multi-Gas/ Vapour/P100	Organic Vapours/Chlorine/ Chlorine Dioxide/ Hydrogen Chloride/Ammonia/Methylamine/ Sulfur Dioxide/Hydrogen Fluoride/Hydrogen Sulfide/ Formaldehyde with P100 particulate filter*	SE904	60926	2	48.67

\*At least 99.97% efficient against solid and liquid aerosols including oils







## PARTICULATE FILTER 2000 SERIES

- Light weight and easy to breathe through
- Suited for a wide range of oil and non-oil based particulate contaminants

Filters	Description	Used For (Possible Applications)	Model No.	Mfg. No.	Qty /Pkg.	Price /Each
	P95 Filter	Grinding, sanding, bagging, welding, other oily/dusty operations	SE906	2071	2	8.17
	P95 Filter w/Hydrogen Fluoride and Nuisance Level Acid Gas	Aluminum smelting, glass etching, chemical manufacturing	SE907	2076	2	16.23
	P95 Filter w/Nuisance Level Organic Vapour and Acid Gas	Chemical manufacturing, welding, aluminum smelting	SE908	2078	2	13.45
	P100 Filter	Welding, metal pouring, pharmaceutical manufacturing	SE909	2091	2	12.45
	P100 Filter w/Acid Gas	Utility operations, chemical manufacturing, aluminum smelting	SE910	2096	2	17.26
	P100 Filter w/Organic Vapour	Welding, metal foundry, chemical manufacturing, undercoating operations, pharmaceutical manufacturing	SE911	2097	2	16.17



## ADVANCED PARTICULATE FILTERS 2200 SERIES

- Features 3M™ advanced electret filter media making it easier to breathe
- Suited for a wide range of oil and non-oil based particulate contaminants

Filters	Description	Used For (Possible Applications)	Model No.	Mfg. No.	Qty /Pkg.	Price /Each
	P100 Advanced Filter	Welding, metal pouring, pharmaceutical manufacturing	SEI738	2291	2	13.69
	P100 Advanced Filter w/ Nuisance Level Acid Gas	Utility Operations, Chemical Manufacturing, Aluminum Smelting	SEI739	2296	2	17.94
	P100 Advanced Filter w/ Nuisance Level Organic Vapour Relief	Welding, Metal Foundry, Chemical Manufacturing, Undercoating Operations, Pharmaceutical Manufacturing	SEI740	2297	2	18.08
	Prefilter Adaptor	Filter adaptor for use with 2000 and 2200 series filters	SE916	502	1	4.70

## PARTICULATE FILTER, P100 AND HYDROGEN FLUORIDE CARTRIDGE/FILTER, P100

- Unique, spring-loaded filter cover design simplifies negative pressure user seal checks
- Swept-back design provides enhanced field of view and greater comfort
- Hard Shell

Filters	Description	Used For (Possible Applications)	Model No.	Mfg. No.	Qty /Pkg.	Price /Each
	P100 Filter	Welding, abatement, metal pouring, pharmaceutical manufacturing	SE912	7093	2	13.71
	P100 Filter w/Hydrogen Fluoride and Nuisance Level Acid Gas	Welding, metal pouring, abatement, pharmaceuticals chemical manufacturing, undercoating	SAQ696	7093C	2	25.68



# REUSABLE RESPIRATORS

## SECURE CLICK™ HF-800 SERIES HALF FACEPIECE REUSABLE RESPIRATORS

- Comes with a speaking diaphragm that's designed to help provide easier communication during work
- Replaces round bayonet connectors with the 3M™ Secure Click™ Connection which functions like a seat belt, simply align the connections and push until there is an audible 'click'
- Silicone face seal with patented flex joint nose bridge helps provide a softer feel for more comfort on the wearer's face
- Easy-adjust head cradle buckles, pull straps to tighten, squeeze the buckles to loosen
- Overmolded design for easy assembly/disassembly
- Exhalation valve helps direct exhaled breath and moisture downward
- Greater breathability and comfort provided by the quad-flow cartridge system
- Low-profile half facepiece design offers a wide field of view and compatibility with certain welding and grinding shields
- Facepiece Material: Silicone



Model No.	Mfg. No.	Description	Price /Each
SGS427	HF-801SD	Small	58.75
SGS428	HF-802SD	Medium	58.75
SGS426	HF-803SD	Large	58.75

## SECURE CLICK™ CARTRIDGES AND FILTERS

Model No.	Mfg. No.	Description	Price /Each
<b>RESPIRATOR CARTRIDGES</b>			
SGS420	D8001	Organic Vapour	23.85
SGS421	D8003	Organic Vapour/Acid Gas	25.76
SGS422	D8006	Multi-Gas/Vapour	27.95
<b>RESPIRATOR CARTRIDGES &amp; FILTERS</b>			
SGS423	D80921	Organic Vapour/P100	49.22
SGS424	D80923	Organic Vapour/Acid Gas/P100	50.51
SGS425	D80926	Multi-Gas/Vapour/P100	53.84
<b>FILTER RETAINERS</b>			
SGS432	D701		4.44
<b>PARTICULATE FILTERS</b>			
SGS438	D7P71	P95 Filter, Replacement Filter Only	39.82
SGS434	D3071	P95 Filter	9.39
SGS440	D7N11	N95 Filter	31.87
SGS435	D3091	P100 Filter	14.34
<b>PARTICULATE FILTERS WITH NUISANCE VAPOUR RELIEF</b>			
SGS436	D3076HF	Acid Gas/P95	18.64
SGS439	D3078	Organic Vapour/Acid Gas/P95	15.46
SGS433	D3097	Organic Vapour/P100	18.63
SGS437	D3096	Acid Gas/P100	19.82

## SECURE CLICK™ FF-800 SERIES FULL-FACEPIECE REUSABLE RESPIRATOR

- Speaking diaphragm designed to help provide easy communication
- Unique filter and cartridge connection snaps into place for intuitive assembly
- Push button seal check is an easy way to conduct (positive pressure) seal check prior to each use
- Large lens helps provide a wide view for excellent peripheral vision
- Scotchgard™ protector on lens for improved paint and stain resistance
- Comfort cradle positions respirator more comfortably on head, reducing pressure points and hair pulling
- Exhalation valve cover helps direct exhaled breath and moisture downward



Model No.	Mfg. No.	Size	Price /Each
SHB859	FF-801	Small	403.48
SHB860	FF-802	Medium	403.48
SHB861	FF-803	Large	403.48



SGS425



SGS432



SGS437



SGS434

## RESPIRATOR CLEANING WIPES

- Used to clean elastomeric and silicone facepiece respirators
- 8" x 10" towelettes are alcohol-free and will not damage the facepiece materials.
- Individually packaged.
- 100 per box.

Model No. SAI530  
Mfg. No. 504  
Price/Each \$83.01



## RESPIRATORS & PPE CLEANING WIPES

- For rubber or latex face and mouth pieces, respirators, etc.
- Alcohol-free
- Avoids "drying-out" associated with alcohol based cleaners
- 5" x 8" individually wrapped towelettes
- 100 towelettes per dispenser

Model No. SEE383  
Price/Each \$14.15



## 5400 SERIES LOW MAINTENANCE FULL FACEPIECE RESPIRATORS

- Elastomer material with high chemical resistance
- Oral nasal cup reduces fogging and lessens dead air space to improve comfort
- Hard-coated polycarbonate lens provides over 200° field vision
- Can be adapted to Honeywell PAPR or supplied air to offer flexibility in the workplace



Cartridges sold separately

**Honeywell**  
NORTH

Model No.	Mfg. No.	Size	Price /Each
SAH792	54001S	Small	204.00
SAH791	54001	Medium/Large	204.00

## 5500 SERIES LOW MAINTENANCE HALF-MASK RESPIRATORS

- Non-allergenic thermoplastic elastomer for comfort and fit
- Contoured sealing flange eliminates discomfort
- Minimal dead air space improves worker comfort by limiting rebreathing of exhaled air
- Direct cartridge to facepiece seal minimizes replacement parts and simplifies maintenance
- Latex-free straps stretch and move with the worker while providing optimum support
- Can be adapted to Honeywell PAPR or supplied air to offer flexibility in the workplace



**Honeywell**  
NORTH

Model No.	Mfg. No.	Size	Price /Each
SM890	550030S	Small	24.20
SM891	550030M	Medium	24.20
SM892	550030L	Large	24.20

## NORTH® RU8500 SERIES HALF MASK RESPIRATORS

- Silicone facepiece is soft and flexible to provide workers with a comfortable fit for hours of use
- Speech diaphragm offers better speech clarity for improved communications
- Dual sealing flange provides excellent facepiece seal
- Woven straps retain shape for secure fit and better comfort; straps are easy to adjust with no excess slack
- Standard industrial exhalation valve cover
- Compatible with Honeywell N-Series cartridges, filters, and cartridge/filter combinations
- NIOSH approved



**Honeywell**  
NORTH

Model No.	Mfg. No.	Size	Colour	Price /Each
SFE051	RU85001S	Small	Royal Blue	71.20
SFE052	RU85001M	Medium	Royal Blue	80.70
SFE053	RU85001L	Large	Royal Blue	81.50

## 7600 SERIES FULL FACEPIECE RESPIRATORS

- Silicone facepiece material conforms to facial features and doesn't harden with age
- Easy to clean and resists distortion
- Protects the wearer's eyes and face against irritating gases, vapours and flying objects
- Oral nasal cup reduces fogging and lessens dead air space to improve comfort
- Speaking diaphragm makes communication easy
- Five-strap harness provides an effective and comfortable facepiece to face seal
- Hard-coated polycarbonate lens provides over 200° field vision
- Can be adapted to Honeywell PAPR or supplied air to offer flexibility in the workplace

**Honeywell**  
NORTH

Cartridges sold separately



Model No.	Mfg. No.	Size	Price /Each
<b>STANDARD</b>			
SM893	760008AS	Small	420.00
SI777	760008A	Medium/Large	420.00
<b>WITH WELDING ADAPTOR</b>			
SEN150	760008ASW	Small	768.00
SEN151	760008AW	Medium/Large	711.00

## 7700 SERIES HALF-MASK RESPIRATORS

- Non-allergenic silicone facepiece material conforms to facial features and doesn't harden with age
- Easy to clean, extremely durable and resists distortion, ensuring a better fit
- Contoured sealing flange and cradle suspension system eliminates discomfort caused by pressure points on facial nerves
- Minimal dead air space improves worker comfort by limiting rebreathing of exhaled air
- Direct cartridge to facepiece seal minimizes replacement parts and simplifies maintenance
- Can be adapted to Honeywell PAPR or supplied air to offer flexibility in the workplace

**Honeywell**  
NORTH

Cartridges sold separately



Model No.	Mfg. No.	Size	Price /Each
ZC352	770030S	Small	45.20
SM802	770030M	Medium	45.20
SA788	770030L	Large	45.20

## RU8800 HALF-MASK RESPIRATORS

Triple flange design = superior fit, comfort and protection. The RU8800 is our top-of-the-line half-mask respirator. Made of soft silicone, it is extremely comfortable, flexible and durable.

- A triple flange fits a wide variety of facial types and provides the ultimate in comfort and superior fit
- Wide, wraparound, pleated silicone facepiece fits a large variety of facial types
- Lateral placement of exhalation valve and cartridge ports enhances field of vision
- Cradle suspension with four-point floating yoke eliminates pressure points to enhance comfort

**Honeywell**  
NORTH

Cartridges sold separately



Model No.	Mfg. No.	Size	Price /Each
SFU942	RU88001S	Small	72.60
SFU943	RU88001ML	Medium/Large	71.30

# REUSABLE RESPIRATORS

## RU6500 SERIES FULL FACEPIECE RESPIRATORS

- Wide viewing area for distortion-free visibility and optical clarity
- Polycarbonate lens with 200° field of vision
- Silicone nose cup provides excellent facepiece seal and offers a soft, comfortable fit ideal for all day use
- Enhanced head harness offers quick and easy adjustments
- Deep threaded cartridge connector virtually eliminates accidental disconnections and worker exposure to contaminants
- Facepiece material: Silicone
- Can be adapted to Honeywell PAPR or supplied air to offer flexibility in the workplace
- Certification: NIOSH

Model No.	Mfg. No.	Size	Head Harness	Price /Each
SDN448	RU65001S	Small	5-pt Strap	262.00
SDN449	RU65001M	Medium	5-pt Strap	262.00
SDN450	RU65001L	Large	5-pt Strap	262.00
SDN451	RU65002S	Small	Mesh Headnet	299.00
SDN452	RU65002M	Medium	Mesh Headnet	299.00
SDN453	RU65002L	Large	Mesh Headnet	299.00



## BACKPACK ADAPTERS

- Backpack adapter allows users to locate cartridges and filters out of the work zone
- Is easily adaptable to Honeywell North® half mask air purifying respirators and 7600 & 5400 full face piece respirators
- Attaches to the facepiece cartridge connector
- Ideal for tight or highly heated work places
- Like an extension cord for cartridges

Model No. SAO679  
Mfg. No. BP1002  
Price/Each \$146.00



**Honeywell**  
NORTH

## 7900 MOUTHBIT ESCAPE RESPIRATORS

- Easy to use, emergency escape mouthpiece respirators
- Disposable, no need for a maintenance program



**Honeywell**  
NORTH

Model No.	Mfg. No.	NIOSH Approved For (Escape Only)	Price /Each
SM898	7902	Chlorine, Chlorine Dioxide, Sulfur Dioxide, Hydrogen Sulfide	38.40
SM899	7904	Ammonia	41.90

## PARTICULATE PREFILTERS & ACCESSORIES







Filters	Description	Used For (Possible Applications)	Model No.	Mfg. No.	Qty /Pkg.	Price /Each
	N95 Filter	N95 Particulate Filter	SM915	7506N95	10	19.70
	N95 Filter Assembly	Includes: N95 Particulate Filter, Filter Cover, and Filter Holder	SM907	7531N95	2	24.50
	N99 Filter	N99 Particulate Filter	SM916	7506N99	10	27.30
	N99 Filter Assembly	Includes: N99 Particulate Filter, Filter Cover, and Filter Holder	SM909	7531N99	2	25.70
	P100 Filter	P100 Particulate Filter	SM914	75FP100	2	10.50
	Hard Shell P100 Filter	P100 Particulate Filter	SM913	7580P100	2	15.60
	Filter Adaptor	For Use With N Series Cartridges and SM907, SM909 or SM914 Filters	SM917	N750035	1	12.10
	Shower Cap	For SM913 Hardshell P100 filter	SM919	N750029	1	3.19
	Filter Retainer Assembly	For use with SM915 and SM916 filters	SEI517	N750036	1	6.01



## N SERIES GAS/VAPOUR RESPIRATOR CARTRIDGES

Sleek, low profile design provides better balance and a wider field of vision









Cartridges	Description	Approved For	Model No.	Mfg. No.	Qty /Pkg.	Price /Each
	Defender™ Multi-Gas	Organic Vapours, Chlorine, Hydrogen Chloride, Sulfur Dioxide, Hydrogen Sulfide, Hydrogen Fluoride, Chlorine Dioxide, Ammonia, Methylamine, Formaldehyde	SEI595	75SCL	2	21.70
	Organic Vapour	Organic Vapours	SEI596	N75001L	2	19.40
	Acid Gas	Chlorine, Hydrogen Chloride, Sulfur Dioxide, Hydrogen Fluoride, Chlorine Dioxide, Formaldehyde	SEI597	N75002L	2	21.30
	Organic Vapour and Acid Gas	Organic Vapours, Chlorine, Hydrogen Chloride, Sulfur Dioxide, Hydrogen Fluoride, Chlorine Dioxide	SEI598	N75003L	2	19.60
	Ammonia / Methylamine	Ammonia, Methylamine	SEI599	N75004L	2	21.70
	Mercury Vapour / Chlorine with Mercury ESLI (End of Service Life Indicator)	Mercury Vapour, Chlorine Gas	SEI600	N750052L	2	68.80

## N SERIES COMBINATION GAS/VAPOUR/ P100 FILTER RESPIRATOR CARTRIDGES

Sleek, low profile design provides better balance and a wider field of vision



Cartridges	Description	Approved For	Model No.	Mfg. No.	Qty /Pkg.	Price /Each
	Defender™ Multi-Gas w/P100 Filter	Organic Vapours, Chlorine, Hydrogen Chloride, Sulfur Dioxide, Hydrogen Sulfide, Hydrogen Fluoride, Chlorine Dioxide, Ammonia, Methylamine, Formaldehyde, P100 Particulate Filter	SEI601	75SCP100L	2	39.20
	Organic Vapour w/P100 Filter	Organic Vapours, P100 Particulate Filter	SEI602	7581P100L	2	37.90
	Acid Gas w/P100 Filter	Chlorine, Hydrogen Chloride, Sulfur Dioxide, Hydrogen Fluoride, Chlorine Dioxide, Formaldehyde, P100 Particulate Filter	SEI603	7582P100L	2	40.00
	Organic Vapour and Acid Gas w/P100 Filter	Organic Vapours, Chlorine, Hydrogen Chloride, Sulfur Dioxide, Hydrogen Fluoride, Chlorine Dioxide, P100 Particulate Filter	SEI604	7583P100L	2	38.40
	Ammonia / Methylamine w/P100 Filter	Ammonia, Methylamine, P100 Particulate Filter	SEI605	7584P100L	2	41.40
	Mercury Vapour / Chlorine with Mercury ESLI w/P100 Filter	Mercury Vapour, Chlorine Gas, P100 Particulate Filter	SEI606	75852P100L	2	81.60

# REUSABLE RESPIRATORS

## ADVANTAGE® 200 LS HALF FACEPIECE RESPIRATORS

- Clear blue facepiece subtracts 25% of the weight and adds noticeable softness to give workers more comfort and stability than ever
- AnthroCurve™ sealing surface, which instantly conforms to each wearer's unique facial characteristics
- The unmatched fit and comfort start with a soft, pliable combination of rubber and plastic that provides a virtually customized fit
- Patented MultiFlex® system equalizes pressure on the face-seal area while delivering exceptional stability



SAG058

Model No.	Mfg. No.	Size	Price /Each
<b>2-PIECE NECK STRAP</b>			
SAG058	815696	Small	29.80
SAG059	815692	Medium	29.80
SAG060	815700	Large	29.80
<b>SINGLE NECK STRAP</b>			
SAG061	815448	Small	28.70
SAG062	815444	Medium	28.70
SAG063	815452	Large	28.70

## ADVANTAGE® 420 HALF-MASK RESPIRATORS

- Mask can be adjusted to wearer for a comfortable fit, helping to reduce potential pressure points throughout the day
- Adjustable crown strap adapts to different head sizes
- Patented yoke and harness design enables quick and easy switch between lock-down and drop-down modes
- Dropdown mode allows users to remove the facepiece and rest it safely against the chest while maintaining use of head protection they may be wearing
- Lock-down harness mode allows the user to lock in personal fit so that the respirator can be donned without further adjustments
- Has only 3 major components, keeping replacement and maintenance costs down
- Can be used with plastic Advantage Cartridges or threaded metal Comfo Cartridges (sold separately)
- Facepiece design provides stability and soft feel
- Built-in moisture release chin cup hole, and extra-wide head and neck straps
- Designed for easy integration with other personal protective equipment such as safety glasses and welding shields
- Features facepiece, head cradle, elastic straps, buckle set, yoke with lever, two (2) inhalation valves, one (1) exhalation valve
- Facepiece Material: Elastomer



Model No.	Mfg. No.	Size	Price /Each
SHA199	10102182	Small	65.00
SHA200	10102183	Medium	65.00
SHA198	10102184	Large	65.00

## ADVANTAGE® 900 HALF-MASK RESPIRATORS

- Designed for repeated cleaning and decontamination resulting in dramatic cost savings over filtering face piece respirators
- The included mechanical speaking diaphragm allows for improved communication among essential workers, patients and the public
- Does not have an exhalation valve which allows for filtration of exhaled air, thereby providing a means of source control and use in a sterile field environment
- Reuse and cleaning capability make the Advantage 900 respirator a more eco-friendly alternative by removing single use disposable alternatives from the waste stream
- Overmolded multiflex nose cup provides stability and on the user's face and while maintaining a secure fit
- Anthrocurve face piece design maximizes fit and comfort and reduces potential leak points
- A suitable respiratory protection solution for essential workers, including those in healthcare, food processing, fire service, first responder, EMS and other essential industries
- Rear clasp and drop-down head harness keeps straps away from users face
- Respirators can be stored indefinitely for stockpile purposes and filters have a proven storage time of 10 years
- Facepiece Material: Elastomer
- Approval(s): NIOSH



Model No.	Mfg. No.	Size	Price /Each
SGZ282	10218527	Small	94.20
SGZ283	10218528	Medium	94.20
SGZ284	10218529	Large	94.20

## ADVANTAGE® 3000 FULL FACEPIECE RESPIRATORS

- Full-face respirator features a wraparound lens combined with a soft, pliable silicone facepiece
- For the utmost in convenience, Advantage® 3000 uses the same cartridges and filters as the Advantage® 200 LS respirator
- Lower breathing resistance; includes a standard nosecup that reduces fogging in low temperatures or high humidity conditions
- Scratch-resistant coating has been engineered to be optically correct, giving you superior visibility and peripheral vision
- Pre-adjustable straps for a consistent fit, time after time
- Choose between standard rubber harness or Advantage® harness that dons like a catcher's mask
- Cover lenses available



SAG064



Model No.	Mfg. No.	Size	Price /Each
<b>RUBBER HEAD HARNESS</b>			
SAG064	10028996	Small	353.00
SAG065	10028995	Medium	353.00
SAG066	10028997	Large	353.00
<b>ADVANTAGE® HEAD HARNESS</b>			
SAM909	10031340	Small	353.00
SAM910	10031309	Medium	353.00
SAM911	10031341	Large	353.00

## ADVANTAGE GAS/VAPOUR RESPIRATOR CARTRIDGES

- Lightweight, low-profile performance
- Fits MSA Advantage® respirators



Cartridges	Model No.	Mfg. No.	Description	Approved For	Qty /Pkg.	Price /Each
	SAG094	815355	Organic Vapours	Organic Vapours	2	28.70
	SAG096	815356	Acid Gas	Chlorine/Sulfur Dioxide/Chlorine Dioxide/Hydrogen Chloride/Hydrogen Sulfide(Escape Only)	2	30.10
	SAG098	815357	Organic Vapours/Acid Gas	Organic Vapours/Chlorine/Sulfur Dioxide/Chlorine Dioxide/Hydrogen Chloride/Hydrogen Chloride/Hydrogen Sulfide(Escape Only)	2	28.70
	SAG102	815359	Multi-Gas	Organic Vapours/Chlorine/Sulfur Dioxide/Chlorine Dioxide/Hydrogen Sulfide(Escape Only)/Formaldehyde/Hydrogen Fluoride	2	27.60
	SAG100	815358	Ammonia/Methylamine	Ammonia/Methylamine	2	32.50
	SAG105	815361	Mercury Vapour/Chlorine Gas	Mercury Vapour/Chlorine Gas	2	60.10

## ADVANTAGE COMBINATION GAS/VAPOUR/P100 RESPIRATOR CARTRIDGES

- Lightweight, low-profile performance
- Fits MSA Advantage® respirators
- Combines gas/vapour protection with a permanently attached P100 filter



Cartridges	Model No.	Mfg. No.	Description	Approved For	Qty /Pkg.	Price /Each
	SAG095	815362	Organic Vapours/P100	Organic Vapours Permanently Preattached P100 Filter	2	52.90
	SAG097	815363	Acid Gas/P100	Chlorine/Sulfur Dioxide/Chlorine Dioxide/ Hydrogen Chloride/ Hydrogen Sulfide(Escape Only)/Permanently Preattached P100 Filter	2	55.70
	SAG099	815364	Organic Vapours/Acid Gas/P100	Organic Vapours/Chlorine/Sulfur Dioxide/Chlorine Dioxide/Hydrogen Chloride/ Hydrogen Sulfide(Escape Only) Permanently Preattached P100 Filter	2	52.90
	SAG103	815366	Multi-Gas/P100	Organic Vapours/Chlorine/Sulfur Dioxide/Chlorine Dioxide/Hydrogen Chloride/ Hydrogen Sulfide(Escape Only)/Formaldehyde/Hydrogen Fluoride Permanently Preattached P100 Filter	2	48.50
	SAG101	815365	Ammonia/Methylamine/P100	Ammonia/Methylamine/P100	2	55.70
	SAG106	815368	Mercury Vapour/Chlorine Gas/P100	Mercury Vapour/Chlorine Gas/P100	2	86.80

## ADVANTAGE RESPIRATOR CARTRIDGE FILTERS & PREFILTERS

- For use with Advantage® respirators and cartridges



Filters	Model No.	Mfg. No.	Description	Approved For	Qty /Pkg.	Price /Each
	SAG107	815369	P100 Hard Shell Filter	99.97% Efficiency Against Particulate Aerosols	2	18.20
	SAG108	816357	N95 Prefilter	95% Efficiency Against Non-Oil Particulate Aerosols	10	39.70
	SAG110	815392	N95 Prefilter Retainer	Use with N95 Prefilter	2	11.60
	SAG111	815401	R95 Prefilter Retainer	Use with R95 Prefilter	2	11.60

## FLEXI-FILTER® RESPIRATOR FILTERS

- Low profile flexible filters fit well under a welding hood or with other personal protection equipment
- Great balance and weight distribution for maintaining a good face seal
- Swept-back design provides improved vision and comfort



Filters	Model No.	Mfg. No.	Description	Approved For	Qty /Pkg.	Price /Each
	SAG112	818342	P100	99.97% Efficiency Against Particulate Aerosols	2	11.60
	SAG113	818343	P100 w/Nuisance Level Organic Vapour & Ozone Relief	99.97% Efficiency Against Particulate Aerosols	2	15.70
	SAG116	818346	N95	95% Efficiency Against Non-Oil Particulate Aerosols	2	11.00
	SAG117	818347	N95 w/Nuisance Level Organic Vapour Relief	95% Efficiency Against Non-Oil Particulate Aerosols	2	15.20
	SAG120	818354	P95	95% Efficiency Against Particulate Aerosols	2	11.00
	SAG121	818355	P95 w/Nuisance Level Organic Vapour Relief	95% Efficiency Against Particulate Aerosols	2	15.20



# ELASTOMERIC RESPIRATORS



## 7000/7800 SERIES RESPIRATORS

- Designed to be the most user friendly respirator on the market
- Features fewer parts, minimal maintenance, and a wider field of vision
- Ultra lightweight, durable, and economical

## 7000/7800 HALF-MASK RESPIRATORS

- Low profile, angled cartridge placement for wider field of vision
- Easy mount bayonet cartridge/filter attachment
- Adjustable head harness for a custom fit
- Contoured neck buckles for comfort and quick attachment
- Compact, fits under welding helmets
- Wide flange fits more facial shapes comfortably
- Attached exhale cover for easy inspection



Model No.	Mfg. No.	Size	Facepiece Material	Price /Each
<b>7000 SERIES</b>				
SECS63	7001	Small	Thermoplastic	28.00
SECS64	7002	Medium	Thermoplastic	28.00
SECS65	7003	Large	Thermoplastic	28.00
<b>7800 SERIES</b>				
SGC366	7801	Small	Silicone	75.40
SGC367	7802	Medium	Silicone	75.40
SGC368	7803	Large	Silicone	75.40

## 9000 FULL FACEPIECE RESPIRATORS

- Lightweight facepiece weighs less than 12.7 oz.
- Stand away head harness for easy donning
- Over-molded buckles for secure strap attachment with one finger strap release
- Panoramic lens with peripheral vision side panels is scratch resistant and includes a tear away lens protector
- Integrated exhale area with attached cover has fewer parts for simple maintenance and inspection



Model No.	Mfg. No.	Size	Price /Each
SECS67	9001	Small	271.00
SECS68	9002	Medium	271.00
SECS69	9003	Large	271.00

### ACCESSORIES

Model No.	Mfg. No.	Description	Qty /Pkg.	Price /Each
SECS74	0093	Faceshield Protectors	15	56.10

## PRE-ASSEMBLED PAINT/SPRAY PESTICIDE 7000 HALF-MASK RESPIRATORS



Model No.	Mfg. No.	Size	Description	Price /Each
SECS66	7112	Medium	Includes 7000 half-mask respirator, organic vapour cartridges, N95 Prefilters and prefilter retainers	67.30

## SEMI-RECTANGULAR RESPIRATOR CARTRIDGES, FILTERS & ACCESSORIES



Priced per Package

	Description	Model No.	Mfg. No.	Qty /Pkg.	Price /Each
	Organic Vapour	SHH491	7107	2	25.10
	Acid Gas Cartridge	SHH492	7207	2	27.70
	Organic Vapour/Acid Gas	SHH493	7307	2	26.70
	Ammonia, Methylamine	SHH494	7407	2	32.50
	Formaldehyde	SHH495	7507	2	33.50
	Multi-Gas/Vapour	SHH496	7607	2	27.30
	P100 Filter	SHH497	7740	2	16.50
	P100+ Filter	SHH498*	7740 +	2	18.90
	Organic Vapour/Acid Gas/P100	SHH499	7750	2	23.20
	Organic Vapour/Acid Gas/P100+	SHH500*	7750 +	2	26.50
	Organic Vapour/P100	SHH501	7760	2	22.30
	Organic Vapour/P100+	SHH502*	7760 +	2	25.70
	Piggyback Adaptor for 7740 Filter	SHH503	7820	2	10.60
	Protective Filter Cover	SHH504	7888	2	8.76

\* With IonicAir Filtration Technology™

## VERSAFLO™ TR-300 POWERED AIR PURIFYING RESPIRATORS (PAPR)



- Significantly smaller and lighter than existing 3M™ belt-mounted PAPR's
- Weight is kept close to the users back, reducing the leverage effect that can cause PAPRs to feel heavier
- Slim profile is designed for use in tight spaces
- Simple, 1-button operation
- Two types of alarms – one audible and one LED – alert the user to either a low battery or low airflow
- Battery and filter can be changed quickly and easily by hand
- Smooth surfaces are less prone to snagging on objects, and facilitate fast wipe downs for easy cleaning
- Air inlet design helps make sitting possible without compromising air intake
- Window on the filter cover allows easy identification of the type of filter installed
- Lightweight lithium ion battery charges quickly and has no memory effect or heavy metals
- LED lights on the battery indicate its charge status both on and of the charger
- Two selectable flow options offer users greater comfort

### ORDER A COMPLETE ASSEMBLY

Model No.	Mfg. No.	Description	Price/Each
SGL036	TR-306N+	Includes: Versaflo™ PAPR Assembly with High Durability Belt, High Capacity Battery, Single-Station Charger and HE Filter	1951.09
SGL037	TR-307N+	Includes: Versaflo™ PAPR Assembly with Easy Clean Belt, High Capacity Battery, Single-Station Charger and HE Filter	1939.83

### CREATE A CUSTOMIZED PAPR ASSEMBLY – STEP BY STEP

#### 1. START WITH:

Model No.	Mfg. No.	Description	Price/Each
SGL038	TR-302N+	Versaflo™ TR-300 PAPR Assembly	896.00

#### 2. THEN ADD ONE OF THE FOLLOWING FOUR BELT/BACKPACK OPTIONS:

Model No.	Mfg. No.	Description	Price/Each
SEI822	TR-325	Standard Belt	50.92
SEI823	TR-326	High Durability Belt	111.31
SEH940	TR-327	Easy Clean Belt	107.56
SHG647	TR-927	Backpack	276.42

#### 3. ADD A BATTERY:

Model No.	Mfg. No.	Description	Price/Each
SEI826	TR-332	High Capacity Battery	553.37

#### 4. NEXT, SELECT FROM THESE TWO CHARGING OPTIONS:

Model No.	Mfg. No.	Description	Price/Each
SEI827	TR-341N	Single-Station Charger	415.35
SEI828	TR-344N	4-Station Charger	1629.96

#### 5. FINALLY, CHOOSE ONE OF THE FOLLOWING FILTER OPTIONS:

Model No.	Mfg. No.	Description	Qty/Pkg.	Price/Each
SDL057	TR-3712N-5	High Efficiency (HE) Filter	5	383.15
SDL058	TR-3712N-40	High Efficiency (HE) Filter	40	2937.36



SGL036



SGL038



SEI822



SHG647



SEI826



SEI827



SDL057

## VERSAFLO™ COMPLETE PAPR SYSTEMS

### HEAVY INDUSTRY PAPR KIT

- A complete particulate PAPR system for industrial applications where combined respiratory, head, eye and face protection is required or desired
- Includes: respiratory hard hat, PAPR assembly with high durability belt, a heat resistant neoprene rubber breathing tube, a single-station battery charger, an HE filter, and a spark arrestor prefilter

Model No. SGL039  
Mfg. No. TR-300N+HIK  
Price/Each \$2958.75



SGL039

### EASY CLEAN PAPR KIT

- Perfect for many food and beverage, pharmaceutical, and healthcare applications
- Includes: hood assembly with single shroud, PAPR assembly, easy clean belt, a self-adjusting length breathing tube, single-station battery charger, an HE filter and a prefilter

Model No. SGL040  
Mfg. No. TR-300N+ECK  
Price/Each \$2296.06



SGL040

### HEADCOVER PAPR KIT

- The easiest way to select a complete system for hospital, healthcare, and pharmaceutical applications
- Includes: headcover w/ integrated comfort suspension, PAPR assembly, easy clean belt, a self-adjusting length breathing tube, single-station battery charger and an HE filter



SGL041

Model No.	Mfg. No.	Size	Price/Each
SGL041	TR-300N+HKS	Small	2389.30
SGL042	TR-300N+HKL	Large	2389.30

# RESPIRATOR ACCESSORIES

## ULTRA SWIPES

- Disposable cloths clean, disinfect and deodorize hard surfaces and instruments
- Ethanol formulation provides hospital-level disinfection to destroy a wide range of pathogens, including HIV-1 (AIDS) and TB in just 1 minute
- 160 sheets per canister

Model No. JA984  
Price/Each \$40.50



## RESPIRATOR CLEANING WIPES

- Used to clean elastomeric and silicone facepiece respirators
- 8" x 10" towelettes are alcohol-free will not damage the facepiece materials.
- Individually packaged.
- 100 per box.

Model No. SAI530  
Mfg. No. 504  
Price/Each \$83.01



## FIT TEST KITS

### IRRITANT SMOKE FIT TEST KITS

- Facilitates testing required under CSA standard Z94.4-02
- Includes: Six irritant smoke tubes (15 tests/tube), aspirator bulb, tube tip breaker, record form, instruction manual and a hard shell plastic case

**Note:** The irritant smoke test protocol requires that the test be conducted in a well-ventilated area. The use of a tent or hood is prohibited and will not comply with OSHA regulations.

Misuse of these products may result in serious injury or death.



Model No.	Mfg. No.	Description	Price /Each
SAM213	140090	Irritant Smoke Fit Test Kit	273.00
SAQ164	140038	Replacement Tubes, Irritant Smoke (6/box)	134.00

## RESPIRATORS & PPE CLEANING TOWELETTES

- For rubber or latex face and mouth pieces, respirators, etc.
- Alcohol-free
- Avoids "drying-out" associated with alcohol based cleaners
- 5" x 8" individually wrapped towelettes
- 100 towelettes per dispenser

Model No. SEE383  
Price/Each \$14.15



## FIT TEST KITS

- Meets the performance criteria for fit testing respirators under the current OSHA Standard for Respirator Protection and CSA Standard Z94-4
- A fast, easy method for performing qualitative fit testing
- Can be used with any particulate respirator or any gas and vapour respirator with a particulate filter
- Helps satisfy respiratory program requirements
- Can be used during respirator training programs
- Convenient, reliable, and economical to use
- Determines employee's taste threshold to fit test solution
- Allows exercises to be performed in a test atmosphere

### QUALITATIVE FIT TEST KIT WITH SWEET TESTING SOLUTION

Model No. SAK078  
Mfg. No. FT-10  
Price/Each \$543.27

### FT-30 QUALITATIVE FIT TEST KIT WITH BITTER TESTING SOLUTION

Model No. SAK085  
Mfg. No. FT-30  
Price/Each \$516.11





## CARBON MONOXIDE MONITOR WITH TEMPERATURE & HUMIDITY

- Measures carbon monoxide (CO), air temperature and relative humidity
- Features a large LCD display, built-in clock and calendar, max hold function and user-adjustable alarm limit
- Can be mounted on a wall or placed on desktop
- Manual CO calibration to zero
- Low battery indicator
- Includes: Desktop Carbon Monoxide (CO) monitor with temperature & humidity, Batteries
- CO Range: 0 - 999 ppm
- Temperature Range: 32° - 122°F (0° - 50°C)
- Power Supply: 4 AAA Batteries, AC Adaptor (Optional)



**REED**

Model No.	Mfg. No.	Description	Price /Each
IB911	R9450	Carbon Monoxide Monitor with Temperature & Humidity	329.00
IB912	R9450-NIST	Carbon Monoxide Monitor with Temperature & Humidity (includes ISO Certificate)	634.00

## CARBON MONOXIDE METER W/TEMPERATURE

- Large LCD dual display shows both carbon monoxide (CO) and temperature measurements
- Adjustable alarm limits
- Low Level battery indicator
- Auto power off
- Automatic zero point adjustment
- Max/Data hold functions
- Stabilized electrochemical CO specific sensor, thermistor temp sensor
- **Includes:** batteries and soft carrying case



**Temperature Range:** 4°F to 158°F (-20°C to 70°C)  
**Resolution:** 1 ppm, 0.1°F  
**Accuracy:** ±0.8°C (±1.5°F)  
**Battery Life:** 200 hrs.  
**Measuring Range:** 1 - 1000 ppm  
**CO Accuracy:** 5 ppm ±  
**CO Reading Accuracy:** 15% ±  
**Weight:** 0.5 lbs

**Model No. IB731**  
**Mfg. No. R9400**  
**Price/Each \$259.00**

**REED**

## COMBUSTIBLE GAS DETECTORS

- Following is a partial list of the more common gases detected: natural gas; propane; butane; methane; acetone; alcohol; ammonia; steam; carbon monoxide; gasoline; jet fuel; hydrogen sulfide; smoke; industrial solvents; lacquer thinner; naphtha
- Audible and visible alarms
- Low power semi-conductor sensor
- **Includes:** Soft carrying case and batteries

**Sensitivity:** 50 ppm methane  
**Warm-up Time:** Approx. 5 minutes  
**Response Time:** < 2 seconds  
**Alarm Limit:** At 10% LEL for methane  
**Power Supply:** 3 x "C" batteries  
**Battery Life:** 8 hours of continuous use  
**Probe Length:** 16"

**Model No. IA394**  
**Mfg. No. R9300**  
**Price/Each \$139.00**



**REED**

## DATA LOGGING INDOOR AIR QUALITY METER

- Measures CO<sub>2</sub>, CO, O<sub>2</sub>, humidity and temperature
- Non-dispersive infrared CO<sub>2</sub> sensor
- Galvanic cell CO and O<sub>2</sub> sensors
- Precision capacitance humidity sensor
- Records readings from three probes simultaneously
- Audible alarm setpoint
- Temperature is measured in °C or °F
- Easy to read LCD with backlight
- Data hold and Max/Min record
- Real time data logger with integral SD memory card (optional)
- Auto or manual power off
- **Includes:** humidity probe, CO probe, CO<sub>2</sub> probe, O<sub>2</sub> probe, and hard carrying case

**CO<sub>2</sub> Range:** 0 to 4000 ppm  
**Resolution:** 1 ppm  
**Accuracy:** ±40 ppm (<1000 ppm), ±5% (>1000 ppm)  
**CO Range:** 0 to 1000 ppm  
**Resolution:** 1 ppm  
**Accuracy:** ±(5% + 2 ppm)  
**O<sub>2</sub> Range:** 0 - 30% O<sub>2</sub>  
**Resolution:** 0.1% O<sub>2</sub>  
**Accuracy:** ±(1% + 0.2% O<sub>2</sub>)  
**Alarm Threshold:** <18.0% O<sub>2</sub>  
**Humidity Range:** 5 to 95% RH  
**Resolution:** 0.1% RH  
**Accuracy:** >70%RH: ±(3% rdg + 1%RH); <70%RH: ±3%RH

**Temperature Range:** 0 to 50.0°C (32 to 122.0°F)  
**Resolution:** 0.1°C/°F  
**Accuracy:** ±0.8°C (±1.5°F)  
**Dew Point Temp. Range:** -25.3 to 48.9°C (-13.5 to 120.1°F)  
**Wet Bulb Temp. Range:** -21.6 to 50°C (-6.9 to 122.1°F)  
**Power Supply:** 6 AA Batteries, AC Adapter (Not Included)  
**Dimensions:** 177 x 68 x 45 mm; RH Probe: 197 mm L;  
**CO & O<sub>2</sub> Probe:** 150 x 38 x 38 mm; CO<sub>2</sub> Probe: 190 x 38 x 28 mm  
**Weight:** 350 g



**REED**

## TOOLS THAT MEASURE UP!

**AURORA TOOLS**

Model No.	Mfg. No.	Description	Price /Each
IC489	R9910SD	Data Logging Indoor Air Quality Meter	1395.00
IC490	R9910SD-TH	Replacement Temperature Humidity Probe	125.00
IC491	R9910SD-CO	Replacement Carbon Monoxide Probe	229.00
IC492	R9910SD-CO2	Replacement Carbon Dioxide Probe	459.00
IC493	R9910SD-O2	Replacement Oxygen Probe	459.00
IC494	RSD-ADP-NA	Power Adapter	39.00
IC495	RSD-16GB	16GB Memory Card	19.00

# GAS DETECTORS

## ALTAIR® MAINTENANCE-FREE SINGLE-GAS DETECTORS

- Factory-calibrated detector with warranted two-year service life (1080 alarm minutes)
- Sensor options for CO, H<sub>2</sub>S, and O<sub>2</sub>
- Maintenance-free; no sensor or battery change necessary
- Easy bump check and built-in calibration feature
- Event recorder stores last 25 events automatically in instrument memory
- MSA Link™ software-ready
- High capacity battery
- Rated to IP67 for dust and water ingress
- Weight: 4 oz.
- MSA recommends performing a bump test prior to each day's use to confirm sensor response and alarm



HX989

Model No.	Mfg. No.	Hazard	Price /Each
HX989	10092521	H <sub>2</sub> S	259.00
SA0781	10092522	CO	237.00
HX990	10092523	O <sub>2</sub>	259.00

## ALTAIR 4XR MULTIGAS DETECTOR

- 4-year standard warranty on the instrument and all sensors
- Survives multiple 25-ft drops onto concrete for rough handling
- Tough over-molded rubber armour
- Agency-certified dust-and-water-tight IP68 and intrinsically-safe construction
- Large LCD, characters and status icons
- End-of-sensor-life warning
- Industry's first MotionAlert™ and InstantAlert™ features
- 40% less calibration gas used per minute than industry average

Model No.	Mfg. No.	No. of Detectable Gases	Hazard	Colour	Price /Each
SGH381	10178557	4	LEL, O <sub>2</sub> , H <sub>2</sub> S, CO	Grey	1083.00
SGH382	10178558	4	LEL, O <sub>2</sub> , H <sub>2</sub> S, CO	Glow in the dark	1099.00
SGH383	10178566	3	LEL, O <sub>2</sub> , CO	Grey	1605.00
SGH384	10178567	3	LEL, O <sub>2</sub> , CO	Glow in the dark	1635.00
SGH385	10178568	2	LEL, O <sub>2</sub>	Grey	1275.00
SGH386	10178559	2	LEL, O <sub>2</sub>	Glow in the dark	1296.00

### KITS

Model No.	Mfg. No.	No. of Detectable Gases	Hazard	Colour	Description	Price /Each
SGH387	10178356	4	LEL, O <sub>2</sub> , H <sub>2</sub> S, CO	Grey	4XR Multigas Detector	2529.00
SGH388	10178357	4	LEL, O <sub>2</sub> , H <sub>2</sub> S, CO	Grey	4XR Multigas Detector w/ pump probe	3019.00

### ACCESSORIES

Model No.	Mfg. No.	Description	Price /Each
HZ200	10152669	Altair® Pump Probe 50"	915.00
HZ212	10127422	Galaxy® GX2 Multi-Unit Charger For Altair 4X/4XR	735.00
HZ203	10153103	Altair® Pump Probe 10"	145.00
HZ204	10153104	Altair® Pump Probe 25"	199.00
HZ198	10128630	Galaxy® GX2 Automated Test System	5105.00

### ALTAIR® 4XR REPLACEMENT SENSORS

Model No.	Mfg. No.	Hazard	Price /Each
HZ238	10106722	LEL	594.00
HZ241	10106729	O <sub>2</sub>	499.00
HZ242	10106725	CO/H <sub>2</sub> S	765.00
HZ246	10121213	CO/H <sub>2</sub> S (Low Concentration)	598.00
HZ244	10121214	CO/ H <sub>2</sub> S (Hydrogen-Resistant)	935.00
HZ248	10121215	H <sub>2</sub> S/SO <sub>2</sub> (Low Concentration)	878.00
HZ249	10121217	CO/NO <sub>2</sub>	940.00

### CALIBRATION GAS & REGULATORS

Model No.	Mfg. No.	Description	Price /Each
HZ202	10048280	Calibration gas CH <sub>4</sub> , O <sub>2</sub> , H <sub>2</sub> S, CO, 34 Liters	583.00
HZ201*	467895	Fixed Flow Regulator, 0.25 lpm	475.00
HZ208*	710288	Gas Miser™ Demand Regulator, 0.25 lpm - 3.0 lpm	964.00

\* For use with all Model RP and Econo-Cal Calibration Cylinders



SGH381



SGH982



HZ198



HZ201



HZ212



HZ202





## ALTAIR® 5X MULTIGAS DETECTORS

- Can be customer configured for up to 6 gases
- Large buttons and bright display enable quick and easy operation, even when wearing gloves
- Withstands extreme impacts with rugged polycarbonate housing
- End-of-sensor-life warning gives advance notice to user, reducing service outages
- If a user becomes hazardous due to unforeseen hazards, MotionAlert feature will activate after 30 seconds
- InstantAlert feature enables users to manually alert others of a potentially hazardous situation with the push of a button
- Integral pump, 10' sampling line, and 1' probe for confined space applications
- MSA Link™ software-ready
- Rechargeable lithium-ion battery
- Rated to IP65 for dust and water ingress
- Weight: 1 lb



HY008



HZ205

Model No.	Mfg. No.	Hazard	Description	Price /Each
HY008	10115141	LEL, CO, H <sub>2</sub> , O <sub>2</sub> , SO <sub>2</sub>	Monochrome Display	6169.00
HZ205	10115118	LEL, CO, H <sub>2</sub> , O <sub>2</sub>	Monochrome Display	4519.00

### ACCESSORIES

Model No.	Mfg. No.	Description	Price /Each
HZ209	10042621	1' Gas Detection Sample Probe	595.00
HZ210	10105756	Galaxy® GX2 Smart Cylinder Holder	2227.00
HZ211	10125135	Galaxy® GX2 Non-Electronic Smart Cylinder Holder	559.00
HZ213	10127427	Galaxy® GX2 Multi-Unit Charger	755.00
HZ214	10128627	Galaxy® GX2 Automated Test Stand	5209.00



HZ210



HZ213

### ALTAIR® 5X REPLACEMENT SENSORS

Model No.	Mfg. No.	Hazard	Price /Each
HZ252	10080222	ClO <sub>2</sub> Chlorine dioxide	1625.00
HZ253	10080224	NO <sub>x</sub> Nitrogen dioxide	1369.00
HZ254	10106375	HCN Hydrogen Cyanide	1085.00
HZ238	10106722	Ex Combustible (LEL)	594.00
HZ242	10106725	CO/H <sub>2</sub> S	765.00
HZ250	10106726	NH <sub>3</sub> Ammonia	1448.00
HZ247	10106727	SO <sub>2</sub> Sulfur Dioxide	1521.00
HZ251	10106728	Cl <sub>2</sub> Chlorine	1325.00
HZ241	10106729	O <sub>2</sub>	499.00

### CALIBRATION GAS & REGULATORS

Model No.	Mfg. No.	Description	Price /Each
HZ202	10048280	Calibration gas CH <sub>4</sub> , O <sub>2</sub> , H <sub>2</sub> S, CO, 34 Liters	583.00
HZ201*	467895	Fixed Flow Regulator, 0.25 lpm	475.00
HZ208*	710288	Gas Miser™ Demand Regulator, 0.25 lpm - 3.0 lpm	964.00

\* For use with all Model RP and Econo-Cal Calibration Cylinders



HZ247

### XCELL SENSOR APPLICATIONS

	Combustible			Oxygen	Carbon Monoxide			Hydrogen Sulfide		Sulfur Dioxide		Nitrogen Dioxide	Ammonia	Chlorine
	Ex	Ex-M	Ex-H	O <sub>2</sub>	CO/H <sub>2</sub> S	CO-HC	H <sub>2</sub> S/CO H <sub>2</sub> RES	CO/H <sub>2</sub> S	CO/H <sub>2</sub> S LC	SO <sub>2</sub>	H <sub>2</sub> S/SO <sub>2</sub>	CO/NO <sub>2</sub>	NH <sub>3</sub>	Cl <sub>2</sub>
Aeropace	X			X										
Agriculture	X			X	X			X	X			X	X	
Automotive	X			X						X	X	X		
Aviation	X			X								X		
Chemical	X		X		X			X	X	X	X	X	X	X
Fire	X			X	X			X	X					
Food/Beverage	X			X	X			X	X	X	X	X	X	X
Foundries	X			X	X			X	X	X	X	X		
Indoor Air Quality	X			X										
Mining		X		X	X	X		X	X			X		
Oil/Gas/Petroleum	X	X	X	X	X			X	X	X	X		X	
Paper/Pulp	X									X	X	X	X	X
Pharmaceutical	X									X	X		X	X
Power	X									X	X	X	X	
Steel	X				X	X	X	X	X	X	X	X	X	
Water/Wastewater	X				X			X	X	X	X		X	X
Welding	X											X	X	



# GAS DETECTORS

## BW™ ULTRA GAS DETECTORS

- BW™ Ultra is a five-gas detector from Honeywell that is designed specifically for sampling and monitoring confined spaces, before and after entry.
- Large dot matrix LCD screen for easy viewing
- The new 1-Series sensor for enhanced reliability
- Honeywell TouchConnect™ Technology for quicker instrument management
- Remote monitoring for an additional layer of protection
- Expected life for sensors: up to five years.
- Instrument Warranty: 3 Years
- Sensor Warranty: 3 years (2 years NH3, 1 year PID and Cl2)
- Battery Warranty: 2 years
- No. of Detectable Gases: 5



**Honeywell**

Model No.	Mfg. No.	Hazard	Colour of Housing	Price /Each
HZ314	HU-X1W1H1M1S1-Y-N	LEL - O <sub>2</sub> - H <sub>2</sub> S - CO - SO <sub>2</sub>	Yellow	3145.00
HZ315	HU-X1W1H1M1S1-B-N	LEL - O <sub>2</sub> - H <sub>2</sub> S - CO - SO <sub>2</sub>	Black	3145.00
HZ316	HU-X1W1H1M1Q1-Y-N	LEL - O <sub>2</sub> - H <sub>2</sub> S - CO - VOCs	Yellow	3965.00
HZ317	HU-X1W1H1M1Q1-B-N	LEL - O <sub>2</sub> - H <sub>2</sub> S - CO - VOCs	Black	3965.00
HZ318	HU-X1W1H1M1B1-Y-N	LEL - O <sub>2</sub> - H <sub>2</sub> S - CO - CO <sub>2</sub>	Yellow	3965.00
HZ319	HU-X1W1H1M1B1-B-N	LEL - O <sub>2</sub> - H <sub>2</sub> S - CO - CO <sub>2</sub>	Black	3965.00
HZ320	HU-X1W1H1M1A1-Y-N	LEL - O <sub>2</sub> - H <sub>2</sub> S - CO - NH <sub>3</sub>	Yellow	3145.00
HZ321	HU-X1W1H1M1A1-B-N	LEL - O <sub>2</sub> - H <sub>2</sub> S - CO - NH <sub>3</sub>	Black	3145.00

### ACCESSORIES

Model No.	Mfg. No.	Description	Price /Each
HZ324	HU-BOOT	Rubberized Boot	105.00
HZ322	HU-CK-DL	Deluxe Confined Space Kit	899.00
HZ323	HU-CK-CC	Carrying Case	379.00
HZ325	HU-CO1-MCS	5-Bay Charger	539.00
HZ327	HU-PG5	Screen Scratch Protector	125.00
HZ326	HU-ISP	Impact Screen Protector	74.50
HZ400	DX-CASE	Standard Mobile Case	1609.00
HZ401	DX-CASE1	Large Mobile Case	1655.00

## BW™ MICROCLIP X3 MULTI-GAS DETECTORS

- An all-new oxygen sensor that operates consistently for five years - with no replacement costs for the life of the detector - plus a three-year warranty
- Guaranteed runtime for at least a 12-hour shift - down to -20°C - without compromising LEL detection of hydrogen, acetylene and other combustible gases
- IntelliFlash™ light indicating detector has been bump tested and is monitoring correctly
- Durable, rechargeable lithium polymer battery - tested to last in extreme environments
- Ergonomic and wearable - doesn't weigh you down
- Real-time gas concentrations shown on LCD
- Bright, wide-angle visual alarm bars
- IP68 rating ensures maximum protection against dust and water
- User-friendly, tamper-proof operation with just one button and intuitive LCD icons
- Compatible with MicroDock II docking station for automated bump tests and calibration



**Honeywell**

Model No.	Mfg. No.	Hazard	Price /Each
<b>4-GAS DETECTOR</b>			
HZ216	MCX3-XWHM-Y-NA	LEL, O <sub>2</sub> , H <sub>2</sub> S, CO	1047.00
<b>3-GAS DETECTOR</b>			
HZ217	MCX3-XWHO-Y-NA	LEL, O <sub>2</sub> , H <sub>2</sub> S	945.00
HZ218	MCX3-XWOM-Y-NA	LEL, O <sub>2</sub> , CO	945.00
<b>2-GAS DETECTOR</b>			
HZ220	MCX3-XWOO-Y-NA	LEL, O <sub>2</sub>	835.00
HZ221	MCX3-OOHM-Y-NA	H <sub>2</sub> S, CO	835.00
HZ222	MCX3-XOHO-Y-NA	O <sub>2</sub> , H <sub>2</sub> S	835.00
HZ223	MCX3-XOOM-Y-NA	O <sub>2</sub> , CO	835.00
<b>1-GAS DETECTOR</b>			
HZ224	MCX3-XO00-Y-NA	O <sub>2</sub>	735.00
HZ225	MCX3-OOHO-Y-NA	H <sub>2</sub> S	749.00
HZ226	MCX3-OO0M-Y-NA	CO	745.00

## MICROCLIPXL MULTI-GAS DETECTORS

- Slim and compact multi-gas detector is lightweight and comfortable to wear
- Provides affordable protection from up to four hazards
- Rugged and durable water-resistant design with built-in concussion-proof boot
- Features IntelliFlash, a green LED that continuously flashed to provide visual confirmation of detector operation and compliance
- Simple one-button operation offers ultimate ease of use and significantly reduces time spent training the user
- 16 hours of standard data logging and event logging up to 10 events
- Calibration is required only two times per year with a simple one-button automatic procedure
- Powered by a rechargeable battery with extended run-time, especially in cold weather
- Fully compatible with the MicroDock II automatic test and calibration system
- Colour: Yellow



**Honeywell**

Model No.	Mfg. No.	Hazard	Price /Each
<b>4-GAS DETECTOR</b>			
HY082	MCXL-XWHM-Y-NA	LEL, O <sub>2</sub> , H <sub>2</sub> S, CO	889.00
<b>3-GAS DETECTOR</b>			
HY086	MCXL-XOHM-Y-NA	O <sub>2</sub> , H <sub>2</sub> S, CO	865.00
<b>2-GAS DETECTOR</b>			
HY090	MCXL-OOHM-Y-NA	H <sub>2</sub> S, CO	739.00
HY091	MCXL-XOHO-Y-NA	O <sub>2</sub> , H <sub>2</sub> S	735.00
<b>1-GAS DETECTOR</b>			
HY095	MCXL-OOHO-Y-NA	H <sub>2</sub> S	645.00
HY096	MCXL-OO0M-Y-NA	CO	629.00

## Maintain the ideal temperature in your workplace

## BW™ MAX XT II MULTI-GAS DETECTORS

- Reliably monitors up to four hazards, including H<sub>2</sub>S, CO, O<sub>2</sub>, and combustibles
- Straightforward one-button operation
- Robust motorized SmartSample pump for intelligent remote sampling, ideal for confined spaces
- Reliable pump block detection; water and other liquids are prevented from being drawn into the pump
- Calibration is required only two times per year with a simple one-button automatic procedure
- Tamper-proof adjustable options can be customized to suit any application
- Built-in rechargeable lithium battery
- Rugged and durable water resistant design with built-in concussion-proof boot
- Standard data logging and event logging
- Fully compatible with the MicroDock II automatic test and calibration system



HX922

**Honeywell**

Model No.	Mfg. No.	Description	Price/Each
HX922	XT-XWHM-Y-NA	Gas Detector	1325.00
HX923	XT-CK-CC	Carrying Case with Foam Insert	289.00
CONFINED SPACE KITS			
HX924	XT-XWHM-Y-NA-CS	Standard Kit Includes: HX922, IR Connectivity Kit, Regulator, Sampling Probe and Calibration Gas	1925.00
HX925	XT-CK-DL	Deluxe Kit Includes: IR Connectivity Kit, Regulator, 10'/3 m Hose, Sampling Probe and Auxiliary Filter (Detector and Calibration Gas Sold Separately)	1049.00
POWER OPTIONS & SPARES			
HX926	XT-C01-MC5	Five Unit Cradle Charger	515.00
HX905	GA-PA-1-MC5	Five Unit Power Adaptor	275.00
HX906	GA-VPA-1	12-24 VDC Vehicle Power Adaptor	81.90
HX907	GA-PA-3	12-24 VDC Direct-Wire Power Adaptor	92.90

## BW CLIP REAL TIME SINGLE-GAS DETECTORS

- Real-time gas level display with the ability to calibrate the device
- Maintenance-free: no sensor or battery changes necessary
- Offers extended longevity with a field-replaceable battery and sensor
- Compact, lightweight design with one-button operation
- Designed for a range of harsh environments and extreme temperatures
- Hibernation mode with case accessory or IntelliDoX
- Automated self-test of battery, sensor and electronics
- Wide-angle flash, which alerts simultaneously with audible and vibrating alarm
- Automatic logging of the 35 most recent gas events and bump test results
- Compatible with MicroDock II and Fleet Manager II software
- Affordable, with low cost of ownership
- BW recommends performing a bump test prior to each day's use to confirm sensor response and alarm



**Honeywell**

Model No.	Mfg. No.	Hazard	Measuring Range	Default Alarm Setpoints Low	High	Price /Each
BW CLIP REAL TIME 2-YEAR DETECTORS						
HZ270	BWC2R-H	Hydrogen sulfide (H <sub>2</sub> S)	0-100 ppm	10 ppm	20 ppm	329.00
HZ271	BWC2R-HS10	Hydrogen sulfide (H <sub>2</sub> S)	0-100 ppm	5 ppm	20 ppm	329.00
HZ273	BWC2R-M	Carbon monoxide (CO)	0-300 ppm	35 ppm	200 ppm	329.00
HZ274	BWC2R-M50200	Carbon monoxide (CO)	0-300 ppm	50 ppm	200 ppm	329.00
HZ275	BWC2R-X	Oxygen (O <sub>2</sub> )	0-25%	19.5% vol.	23.5% vol.	319.00
HZ276	BWC2R-S	Sulfur Dioxide (SO <sub>2</sub> )	0-100 ppm	5 ppm	20 ppm	555.00
HZ277	BWC2R-S24	Sulfur Dioxide (SO <sub>2</sub> )	0-100 ppm	2 ppm	20 ppm	555.00
BW CLIP REAL TIME 3-YEAR DETECTORS						
HZ278	BWC3R-H	Hydrogen sulfide (H <sub>2</sub> S)	0-100 ppm	10 ppm	20 ppm	409.00
HZ279	BWC3R-M	Carbon monoxide (CO)	0-300 ppm	35 ppm	200 ppm	409.00

## BW CLIP 4 MULTI-GAS DETECTORS

- Alarm Setpoints: 5-10 ppm
- Maintenance-free: no sensor or battery changes necessary
- Compact, lightweight design with one-button operation
- Designed for a range of harsh environments and extreme temperatures
- Automated self-test of battery, sensor and electronics
- Wide-angle flash, which alerts simultaneously with audible and vibrating alarm
- Automatic logging of the 70 most recent gas events and bump test results
- IntelliDoX compatible
- Affordable, with low cost of ownership



HZ284

**Honeywell**



HZ285

Model No.	Mfg. No.	Hazard	Colour	Price /Each
HZ284	BWC4-B-N	O <sub>2</sub> , H <sub>2</sub> S, CO/LEL	Black	829.00
HZ285	BWC4-Y-N	O <sub>2</sub> , H <sub>2</sub> S, CO/LEL	Yellow	835.00

## BW CLIP SINGLE-GAS DETECTORS

- Maintenance-free: no sensor or battery changes necessary
- Offers extended longevity with a field-replaceable battery and sensor
- Compact, lightweight design with one-button operation
- Designed for a range of harsh environments and extreme temperatures
- Hibernation mode with case accessory or IntelliDoX
- Automated self-test of battery, sensor and electronics
- Wide-angle flash, which alerts simultaneously with audible and vibrating alarm
- Automatic logging of the 35 most recent gas events and bump test results
- Compatible with MicroDock II and Fleet Manager II software
- Affordable, with low cost of ownership
- BW recommends performing a bump test prior to each day's use to confirm sensor response and alarm
- Note: Monitors do not have a continuous display of the gas concentration, the concentration of the gas will only be displayed when an alarm point is reached



**Honeywell**

Model No.	Mfg. No.	Hazard	Measuring Range	Default Alarm Setpoints Low	High	Price /Each
BW CLIP 2-YEAR DETECTORS						
HZ174	BWC2-H	Hydrogen sulfide (H <sub>2</sub> S)	1-100 ppm	10 ppm	15 ppm	185.00
HZ175	BWC2-HS10	Hydrogen sulfide (H <sub>2</sub> S)	1-100 ppm	5 ppm	10 ppm	259.00
HZ176	BWC2-HS15	Hydrogen sulfide (H <sub>2</sub> S)	1-100 ppm	5 ppm	15 ppm	269.00
HZ177	BWC2-M	Carbon monoxide (CO)	0-300 ppm	35 ppm	200 ppm	179.00
HZ178	BWC2-M50200	Carbon monoxide (CO)	0-300 ppm	50 ppm	200 ppm	289.00
HZ181	BWC2-X	Oxygen (O <sub>2</sub> )	0-25%	19.5% vol.	23.5% vol.	179.00
HZ179	BWC2-S	Sulfur Dioxide (SO <sub>2</sub> )	0-100 ppm	5 ppm	10 ppm	435.00
HZ180	BWC2-S24	Sulfur Dioxide (SO <sub>2</sub> )	0-100 ppm	2 ppm	4 ppm	435.00
BW CLIP 3-YEAR DETECTORS						
HZ183	BWC3-H	Hydrogen sulfide (H <sub>2</sub> S)	0-100 ppm	10 ppm	15 ppm	339.00
HZ184	BWC3-M	Carbon monoxide (CO)	0-300 ppm	35 ppm	200 ppm	329.00

### ACCESSORIES

Model No.	Mfg. No.	Description	Qty /Pkg	Price /Each
HZ185	CLIPHB-CASE	Hibernation Case for BW Clip	1	28.90
HZ186	CLIPHB-CASE-B50	Hibernation Case for BW Clip	50	1125.00

# GAS DETECTORS

## SOLO GAS DETECTORS

- Easy-to-service, single-gas detector
- Lightweight convenience
- High standards of sensor quality and reliability
- Compatible with IntelliDoX
- Bump testing (qualitative function check) of the sensors, is a recommended function and requires test gas cylinders and bump test accessories
- Provides real-time visibility into the status and safety of hazardous-area workers
- Connected Bluetooth low energy (BLE) capabilities
- Wireless feature allows access from any device with an internet connection to get remote visibility on worker safety and location



HZ329

## Honeywell

Yellow Model No.	Mfg. No.	Black Model No.	Mfg. No.	Hazard	Measuring Range	Price /Each
HZ363	BWS1-C-Y	HZ380	BWS1-C-B	Cl <sub>2</sub>	0 ppm to 100 ppm	629.00
HZ364	BWS1-V-Y	HZ381	BWS1-V-B	ClO <sub>2</sub>	0 ppm to 100 ppm	629.00
HZ365	BWS1-ML-Y	HZ382	BWS1-ML-B	CO	0 ppm to 2000 ppm	515.00
HZ366	BWS1-M2-Y	HZ383	BWS1-M2-B	CO	0 ppm to 2000 ppm	629.00
HZ367	BWS1-E-Y	HZ384	BWS1-E-B	ETO	0 ppm to 50 ppm	855.00
HZ368	BWS1-R-Y	HZ385	BWS1-R-B	H <sub>2</sub>	0 ppm to 1 ppm	865.00
HZ369	BWS1-HL-Y	HZ386	BWS1-HL-B	H <sub>2</sub> S	0 ppm to 100 ppm	515.00
HZ370	BWS1-H2-Y	HZ387	BWS1-H2-B	H <sub>2</sub> S ext range	0 ppm to 1000 ppm	495.00
HZ371	BWS1-Z-Y	HZ388	BWS1-Z-B	HCN	0 ppm to 100 ppm	629.00
HZ372	BWS1-A-Y	HZ389	BWS1-A-B	NH <sub>3</sub>	0 ppm to 200 ppm	759.00
HZ373	BWS1-A2-Y	HZ390	BWS1-A2-B	NH <sub>3</sub> ext range	0 ppm to 500 ppm	799.00
HZ374	BWS1-N-Y	HZ391	BWS1-N-B	Nitric Oxide	0 ppm to 250 ppm	629.00
HZ375	BWS1-D-Y	HZ392	BWS1-D-B	NO <sub>2</sub>	0 ppm to 100 ppm	629.00
HZ376	BWS1-XL-Y	HZ393	BWS1-XL-B	O <sub>2</sub>	0 v/v to 0.3 v/v	515.00
HZ377	BWS1-G-Y	HZ394	BWS1-G-B	O <sub>2</sub>	0 ppm to 1 ppm	1055.00
HZ378	BWS1-P-Y	HZ395	BWS1-P-B	PH <sub>3</sub>	0 ppm to 5 ppm	629.00
HZ379	BWS1-S-Y	HZ396	BWS1-S-B	SO <sub>2</sub>	0 ppm to 100 ppm	629.00

## INTELLIDOX DOCKING STATIONS

- The IntelliDoX system is expandable to five docking modules helping you drive productivity, reliability and efficiency
- Provides a new level of customization for bump testing, configuration and record-keeping in a maintenance-free detector
- Configure alarm set points and change detector settings throughout the operation life of the BW Clip
- Quick and easy setup — great for turnarounds
- Each module has its own easy-to-read LCD screen and keypad for independent operation



HZ402

## Honeywell

Model No.	Mfg. No.	Compatible with	Price/Each
HZ187	DX-CLIP	BW Clip	3169.00
HZ286	DX-MCLP	BW MicroClip XL / MicroClip X3	3169.00
HZ402	DX-SOLO	BW Solo	3169.00
HZ404	DX-ULTRA	BW Ultra	3169.00

### ACCESSORIES

Model	Mfg. No	Description	Price/Each
HZ188*	DX-ENBL-NA	Enabler Kit	355.00
HZ190	DX-MI-KEY	Multi-Inlet Key, For Solo only	495.00

\* Enabler Kit includes power supply with region-specific AC power cord, ethernet cable, inlet (purge) filter assembly, 3 ft. / 1 m calibration gas tubing, 3 ft. / 1 m purge gas tubing, 15 ft. / 4.5 m exhaust tubing, quick connect fittings and IntelliDoX inlet end plate.

## FIVE UNIT CRADLE CHARGER FOR GASALERTMAX XT II MULTI-GAS DETECTORS

Model No. HX926  
Mfg. No. XT-C01-MC5  
Price/Each \$515.00



## Honeywell

**AURORA**  
TOOLS

Celebrating  
**15**  
YEARS

**EXCEEDING EXPECTATIONS**

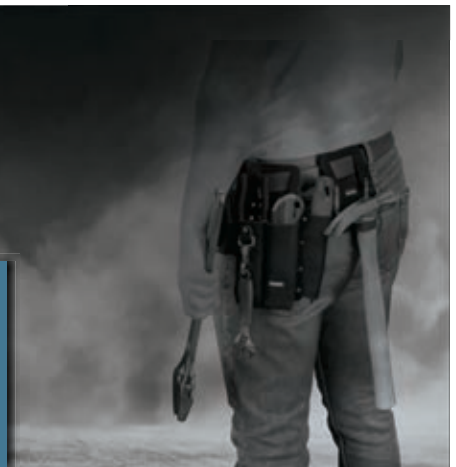



## SAMPLING ACCESSORIES

### MANUAL ASPIRATOR PUMP KITS

- Includes manual aspirator probe, 1' sampling tube, and instrument adaptor



### SAMPLING EQUIPMENT

- Hose kits come with connectors and three particulate filters
- Sample probe comes with hydrophobic and particulate filters



**Honeywell**

**Honeywell**

Model No.	Mfg. No.	Description	Price /Each
HX947	QT-AS01	GasAlertQuattro	189.00
HX948	MC-AS01	GasAlertMicroClip XT	169.00

Model No.	Mfg. No.	Description	Price /Each
HX949	HOSE1-10	10' 3 m Kit	245.00
HX950	HOSE1-20	20' 6.1 m Kit	309.00
HX951	HOSE1-65	65' 19.8 m Kit	549.00
HX955	GA-PROB1-1	1' 0.3 m Sample Probe	85.90

## CALIBRATION EQUIPMENT

%LEL = Combustibles / CH<sub>4</sub> = Methane / Cl<sub>2</sub> = Chlorine / ClO<sub>2</sub> = Chlorine dioxide / CO = Carbon monoxide / CO<sub>2</sub> = Carbon dioxide / ETO = Ethylene oxide / H<sub>2</sub>S = Hydrogen sulfide / HCl = Hydrogen chloride / HCN = Hydrogen cyanide / N<sub>2</sub> = Nitrogen / NH<sub>3</sub> = Ammonia / NO<sub>2</sub> = Nitrogen dioxide / O<sub>2</sub> = Oxygen / O<sub>3</sub> = Ozone / PH<sub>3</sub> = Phosphine / SO<sub>2</sub> = Sulfur dioxide / VOCs = Volatile organic compounds

### CALIBRATION GASES

Model No.	Mfg. No.	Description	Cylinder Material	Compatible Regulator	Balance	Liters	Price /Each
<b>QUINT GAS CYLINDERS (5-GAS MIX)</b>							
HX967	CG-QT34-1	CH <sub>4</sub> (2.5%), O <sub>2</sub> (18.0%), H <sub>2</sub> S (25 ppm), CO (100 ppm), CO <sub>2</sub> (0.5%)	Aluminum	HX976 or HY448	N2	34	565.00
<b>QUAD GAS CYLINDERS (4-GAS MIX)</b>							
HX968	CG-Q34-4	CH <sub>4</sub> (2.5%), O <sub>2</sub> (18.0%), H <sub>2</sub> S (25 ppm), CO (100 ppm)	Aluminum	HX976 or HY448	N2	34	375.00
HX969	CG-Q58-4	CH <sub>4</sub> (2.5%), O <sub>2</sub> (18.0%), H <sub>2</sub> S (25 ppm), CO (100 ppm)	Aluminum	HX976 or HY448	N2	58	455.00
<b>TRIPLE GAS CYLINDERS (3-GAS MIXES)</b>							
HX970	CG-TR34-1	CO (100 ppm), CH <sub>4</sub> (2.5%LEL), O <sub>2</sub> (18.0%)	Steel	HX977 or HY450	N2	34	199.00

Note: Regulators sold separately



HX967



HX976

**Honeywell**

### AEROSOL TEST GASES

Model No.	Mfg. No.	Description	Cylinder Material	Balance	Liters	Price /Each
HX973*	CG-BUMP1	Bump Alarm Test Gas Aerosol H <sub>2</sub> S (40 ppm), CO (200 ppm), CH <sub>4</sub> (2.5%), O <sub>2</sub> (10%)	Aluminum	N2	11	149.00
HX974	CG-BUMP-B-K	Balloon Assembly Kit with Tubing and Adaptor for Bump Gas	-	-	-	53.50
HX975	CG-BUMP-B	Spare Balloons for Bump	-	-	-	39.90

Note: Test gases are used for qualitative functional testing of sensors and alarms only. Test gases cannot be used as calibration gases

\*Requires Balloon Assembly Kit (sold separately)

### REGULATORS & ACCESSORIES

Model No.	Mfg. No.	Description	Price /Each
HX976	REG-0.5	Calibration Gas Regulator (0.5 LPM)	359.00
HX977	REG2-0.5	Calibration Gas Regulator (0.5 LPM)	439.00
HY448	REG-DF-1	Demand Flow Regulator - for Disposable Cylinders	779.00
HX983	MK-CG2-58	Wall Mount for 34, 58, 103 L Gas Cylinders, Red	215.00

Note: MicroDock II requires an HY448. Aerosols do not require regulators.



## CONFINED SPACE RESCUE SYSTEMS

- 3M has an extensive line of rescue and retrieval systems to suit your confined space entry and rescue needs
- High-quality, rugged systems meet applicable industry standards, and can be customized to suit your needs
- Ease-of-use ensures you have the ability to handle a crisis simply, flawlessly, and immediately
- Made from quality materials strong enough to endure rough handling and exposure to the elements
- Systems are adjustable and adaptable to extreme environments and uneven terrain
- Modular design allows you to add to the system over time
- Portable systems are easy to transport, set-up, and store



Fall Protection

## DAVIT ARM SYSTEM COMPONENTS

### ADVANCED ADJUSTABLE OFFSET DAVIT MAST

- Adjustable length of Davit ensures lifelines are always centred over confined space
- Combine with up to two lower mast extensions to increase anchorage height

Model No.	Mfg. No.	Description	Price /Each
SEB442	8518001	Davit Mast, 11 1/2" - 27 1/2" Adjustable Offset	4616.85
SEE775	8518006	Davit Mast, 23 1/2" - 42 1/2" Adjustable Offset	5447.40
SEE776	8518509	Mast Extension, 21"	1313.55
SEE777	8518002	Mast Extension, 33"	1812.30
SEE778	8518003	Mast Extension, 45"	2091.60
SEE779	8518004	Mast Extension, 57"	2482.20



SEB442



SEE780

### ADVANCED PORTABLE BASES

- Work with a variety of advanced davit arm and mast extensions
- Ideal when you need to move and access various confined space areas
- Lightweight, easy to transport, set-up, and use

Model No.	Mfg. No.	Description	Price /Each
SEE780	8518005	For 27 1/2" Maximum Offset Davit Mast	4832.10
SEE781	8518008	For 42 1/2" Maximum Offset Davit Mast	7545.30

### ADVANCED PERMANENT FIXED BASES

- Works with a variety of advanced davit arm and mast extensions
- Fixed bases are ideal for work areas where frequent set-up and tear-down is required
- Base can be permanently installed to an existing structure

Model No.	Mfg. No.	Description	Material	Mounts to	Price /Each
SEJ393	8516190	Floor Mount	Zinc Plated	Concrete or Steel	1011.15
SEJ394	8510316	Floor Mount	Steel	Concrete or Steel	1579.20
SEJ395	8512831	Center Mount	Zinc Plated	Steel, Welding, or Bolting	1382.85
SEJ396	8518348	Wall Mount	Stainless Steel	Concrete or Steel	1893.15
SEJ397	8510109	Core Mount	Zinc Plated	Concrete or Steel	498.75
SEJ398	8515162	Deck Mount	Zinc Plated	Flooring	1468.95



SEJ393

## ADVANCED 5-PIECE DAVIT HOIST SYSTEM

- Davit arm and base system includes adjustable offset upper mast, 33" lightweight lower mast, and 3-piece lightweight base
- Includes winch mounting bracket
- Winch and self-retracting lifelines sold separately

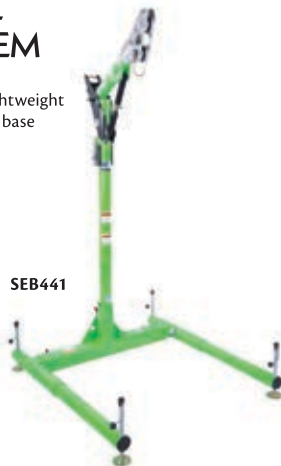

SEB441



Fall Protection

Model No.	Mfg. No.	Maximum Offset Davit Mast"	Price /Each
SEB441	8300009	27 1/2	10063.20
SEE782	8518040	42 1/2	13404.30

## SEALED SELF-RETRACTING LIFELINE WITH RETRIEVAL WINCH

- 50' Sealed SRL w/7' Tripod
- Patented concept that separates all dynamic components from foreign elements such as grease, moisture and dirt
- Self contained bi-directional retrieval winch suitable for raising and lowering personnel in emergency rescue/retrieval situations
- Overload device reduces the possibility of injury should the worker become entangled during retrieval
- Input crank handle brake will prevent movement of the load if the handle is accidentally released
- Self adjusting disk brake will stop a fall and limit the arresting forces to 900 lbs. or less
- Quick-mount bracket that enables the user to attach it to a DBI/SALA support structure (tripod, davit arm, etc.) with ease
- Swiveling anchorage loop to prevent twisting of lifeline



Fall Protection

- Self-locking swivel snap hook with impact indicator
- Reserve lifeline retention system for added safety
- 50' x 3/16" galvanized steel wire rope
- Stainless steel and cast aluminum housing for corrosion resistance
- Certified to CSA standard Z259.2.2, Type 3 RSRL



Model No.	Mfg. No.	Price /Each
SEH133	8301050	8895.00

## 4-PIECE HOIST SYSTEM WITH MANHANDLER HOIST/WINCH

**Honeywell**

- The Four-Piece Hoist System is designed for manhole and confined space entry/retrieval applications
- The modular design allows use of components in various configurations and applications
- Multiple winches and/or lifeline systems may be mounted as required
- Tool-less design breaks the system into lightweight, manageable components for storage, transport, and setup
- The DH-1 features the DH-3 Mast, DH-4 Base, and the ManHandler Hoist/Winch
- Material: Welded Aluminum
- Hardware: Zinc-Plated
- Finish: Safety Yellow Powder Coat
- Rated Capacity: 350lbs (159kg) working load limit @ minimum 4:1 Design Factor

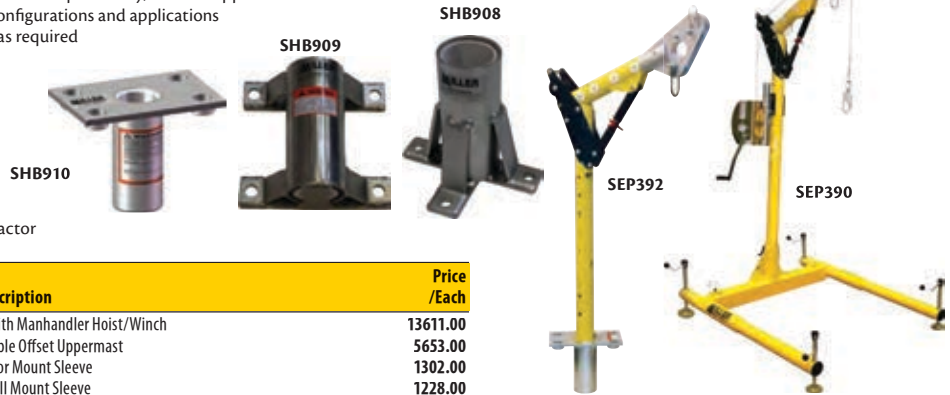

Model No.	Mfg. No.	Description	Price /Each
SEP390	DH-1/	4-Piece Hoist System with Manhandler Hoist/Winch	13611.00
SEP392	DH-21/	12"-29" Adjustable Offset Uppermast	5653.00
SHB908	DH-7ZP/	Miller® Floor Mount Sleeve	1302.00
SHB909	DH-8ZP/	Miller® Wall Mount Sleeve	1228.00
SHB910	DH-20ZP/	Miller® Flush Floor Mount Sleeve	2008.00

## INNOVA XTIRPA™ CONFINED SPACE RESCUE SYSTEMS

- Versatile system can be configured to meet many confined space/rescue applications
- Made of lightweight aluminum composite
- Maximum capacity of 4200 lbs.
- Ergonomic design allows this system to be easily transported and installed by one person; set-up within five minutes for one person
- Easy storage - No vehicle modifications required
- Corrosion resistant, durable system is built to last
- Meets or exceeds applicable CSA, ANSI, and OSHA requirements

### DAVIT ARMS

- Fall protection and retrieval davit arm will facilitate your access to underground chambers and any other confined space
- Equipped with a 5000 lbs. anchor point
- Capacity is 360 lbs. when used with a mast system, and 420 lbs. when used with a manhole guard: safety factor of 10:1
- Weighs just 23 lbs.
- Meets or exceeds applicable CSA, ANSI, and OSHA requirements

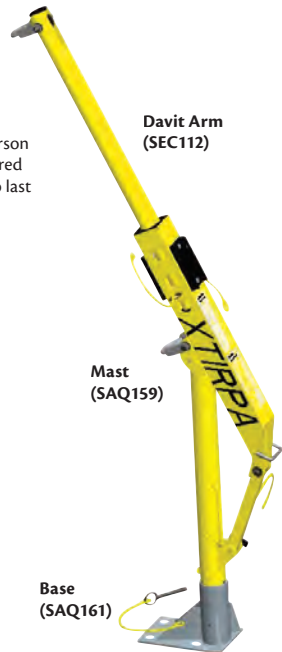

### MASTS

- Designed to be used in conjunction with davit arm (SEC112) and fits all of the permanent or mobile adapters
- Made of aircraft industry aluminum and is very light and durable
- Weighing only 22 lbs., the unit can be used in confined spaces where a versatile and reliable rescue entry/retrieval system is needed

### MANHOLE GUARDS

- Size: 42" H x 38" W x 38" D
- Weight: 29 lbs.
- Integrated mast used in conjunction with a 24" davit arm for confined spaces fall protection and retrieval
- Comes with adjustable feet for simple levelling of system
- Meets or exceeds ANSI, CSA, OSHA & CE
- Material: Steel



**XTIRPA**

**Innova**  
Produits de Services Public - Public Utility Products inc.

Model No.	Mfg. No.	Description	Price /Each
SEC112	IN-2210	Davit Arm	4870.00
SAQ159	IN-2003	Mast	2154.00
SAQ160	IN-2013	Stainless Steel Wall Base	2021.00
SAQ161	IN-2005	Stainless Steel Base	1857.00
SEK149	IN-2108	Manhole Guard	6732.00

## ALUMINUM TRIPOD

- Lightweight and portable
- Ideal for manhole entry and retrieval applications
- Easily set-up by one worker
- Adjustable locking legs
- Will span a 5' diameter hole



**3M** | **DBI SALA**  
Fall Protection

Model No.	Mfg. No.	Description	Price /Each
SEB437	8000014	7' (2.1 m) Aluminum Tripod	2228.00

## SALALIFT II WINCH

- Work support and rescue winch is lightweight and easy to use
- Manually operated by simply rotating the handle to raise or lower personnel or materials
- Incorporates a quick-mount bracket which mates with all DBI Sala® support structures
- Housing made of durable medium-density polyethylene
- Features a self-locking swivel snap hook
- 60' x 1/4" galvanized cable
- Certified to CSA standard Z259.2.2, Type 3 RSRL



**3M** | **DBI SALA** | **SA**  
Fall Protection for Tools

Model No.	Mfg. No.	Description	Price /Each
SEB445	8102060	60' (18 m) x 1/4" (6.25 mm) Galvanized Cable	4507.65



# FALL ARREST & RESCUE

## SEALED BLOK™ SELF-RETRACTING LIFELINES - RETRIEVAL/BACKET

- 30' Sealed Blok™ self-retracting lifeline that features a retrieval bracket and swivelling snap hook with impact indicator
- 3-way emergency retrieval system
- New sealed design keeps the critical working components free of dirt, grease, water and chemicals
- Built-in carrying handle makes transport and anchoring safe and easy, and provides a secondary "dropped objects protection" attachment point
- Large pivoting anchorage handle stays in line with load for added security and allows use of a variety of connecting hardware
- Anti-ratcheting brake stops falls within inches and limits arresting forces to 900 lbs. for added safety
- Cast aluminum housing and heavy gauge steel end plates resist damage and provide corrosion resistance
- Self-locking swivel hook with impact indicator makes connections easy, and provides a visual means of inspection
- Certified to CSA standard Z259.2.2, Type 3 RSRL

Model No. SEB341  
Mfg. No. 3400853C  
Price/Each \$5257.00



## MILLER® TRIPODS

The Miller® tripod is the anchorage connector for typical confined space and rescue systems.

- Lightweight, high-strength aluminum construction
- Adjustable legs with integral push pins, ideal for uneven surfaces
- Safety chain and tripod feet with rubber skid pads and serrated edge prevent slippage in icy conditions
- Independent leg locking feature holds legs securely in place
- Withstands up to 5000 lbs. (22 kN) of vertical pull
- Available with reflective tape



Model No.	Mfg. No.	Description	Price /Each
SAK436	51/7FT	7' (2.1m)	1923.00
SHB911	51X/9FT	9' (2.7m)	2216.00

## MANHANDLER® HOISTS/WINCHES

- Compact, durable steel construction
- Smooth, controlled winding action
- Effortless lifting and lowering with 5:1 gear ratio
- Anti-backlash crank handle braking system prevents free-wheeling
- Digital indicating system which counts drum turns in order to determine maintenance periodicity
- Built-in mounting bracket
- 3/16" galvanized steel cable
- 350 lbs. (1.6 kN) working capacity



Model No.	Mfg. No.	Description	Price /Each
SAR489	8442-Z7/65FT	ManHandler® Hoist w/ 65 ft. 3/16" Galvanized Steel Cable	4239.00

## SEALED SELF-RETRACTING LIFELINE W/RETRIEVAL WINCH

- This sealed SRL incorporate a revolutionary patented concept that separates all dynamic components from foreign elements such as grease, moisture and dirt, ensuring your SRL is always operating at peak efficiency, no matter how dirty or damp your environment
- Incorporates a self contained bi-directional retrieval winch suitable for raising and lowering personnel in emergency rescue/retrieval situations
- Winch drive incorporates an overload device thus reducing the possibility of injury should the worker become entangled during retrieval
- Input crank handle brake will prevent movement of the load if the operator accidentally released the handle during raising/lowering
- In the event of a fall, the self adjusting disk brake will stop the fall and limit the arresting forces imposed on the worker to 900 lbs. or less
- Incorporates a quick-mount bracket that enables the user to attach it to a DBI/SALA support structure (tripod, davit arm, etc.) with ease
- Swivelling anchorage loop to prevent twisting of lifeline
- Self-locking swivel snap hook with impact indicator
- Reserve lifeline retention system for added safety
- 50 ft. 3/16" galvanized steel wire rope for durability
- Stainless steel and cast aluminum housing for corrosion resistance
- Certified to CSA standard Z259.2.2, Type 3 RSRL



Model No.	Mfg. No.	Description	Price /Each
SEN426	3400923C	15 m (50') Sealed SRL	6323.00
SEH133	8301050	15 m (50') Sealed SRL w/7' Aluminum Tripod	8895.00

## ADVANCED DIGITAL SERIES WINCHES

- Performs both descent and retrieval functions
- Removable aluminum crank handle
- Utilizes both 9:1 and 4:1 drives
- Capable of average speeds from 4 m/min (13 ft/min) up to 9 m/min (30 ft/min)
- Manually operated by simply rotating the handle to raise or lower personnel or materials
- Features a self-locking swivel snap hook
- Built-in mounting bracket
- 60' x 1/4" galvanized cable

Model No. SEJ417  
Mfg. No. 8518560  
Price/Each \$4908.75



## WORKMAN™ RESCUER

- Stainless steel 3/16" wire rope
- Integral mounting bracket
- Color-coded switch for retrieval mechanism activation
- Ergonomic, stainless steel carrying handle can also be used as anchorage connection point
- Built-in shock absorber
- Robust aluminum housing with thermoplastic bumpers
- Self-locking swivel snap hook with load indicator
- Stow-able, foldable crank handle
- RFID-enabled
- No. of SRLs: 1
- Lifeline Length: 50'
- Lifeline Material: Stainless Steel Cable
- Harness Connection: Snap Hook
- Anchorage Connection: Built-in

Model No. SGC230  
Mfg. No. 10158180  
Price/Each \$2868.00



## THE ABC'S OF FALL PROTECTION

A typical Person Fall Arrest System (PFAS) incorporates three components, often described as the ABC's of fall protection. The anchorage connector, body support, and connecting device, when used together, form a complete system for maximum worker protection. But don't forget about the other components of any fall protection program; D: descent, rescue, and retrieval of a fallen worker, E: education, and F: fall protection for tools.



Fall Protection



**A**nchorage is a secure point of attachment. They must be able to hold fast under more than a ton of force generated in a fall.



**B**ody support harnesses distribute fall forces over the upper thighs, pelvis, chest, and shoulders. They provide a connection point on the worker for the PFAS.



**C**onnectors such as shock absorbing lanyards or self retracting lifelines connect a workers harness to the anchorage.



**D**escent and rescue devices are used to retrieve an injured worker or lower him to the ground.



**E**ducation is essential. We offer a variety of training and consultative services to fit your needs.



**F**all Protection for Tools helps make work environments safer and more productive by reducing dropped object incidents

## FULL BODY HARNESS APPLICATIONS

CSA STANDARD Z259.10 DIVIDES HARNESSES INTO 5 CLASSES:



### CLASS A

#### PERSONAL FALL ARREST

Class A full body harnesses are designed to support the body during and after the arrest of a fall.



### CLASS D

#### SUSPENSION AND CONTROLLED DESCENT

Class D full body harnesses are designed for suspension or controlled descent from a height.



### CLASS E

#### LIMITED ACCESS (EVACUATION)

Class E full body harnesses are designed to support a worker in a position that reduces the worker's profile during passage through a limited access area.



### CLASS L (LADDER)

#### LADDER CLIMBING

Class L full body harnesses are designed for use with fall restrict systems involving the use of a fall arrester that travels on a vertical lifeline or rail.



### CLASS P

#### WORK POSITIONING

Class P full body harnesses are designed to position a worker during a work operation.

## FALL PROTECTION KIT

- 3-point adjustable harness with mating buckles
- 1 back D-ring, and 2 tear away lanyard keepers
- Rope grab with 30" energy absorbing lanyard
- 50ft polyester vertical lifeline with snap hook
- Reusable roof anchor with screws
- Storage bucket and lid



Model No.	Mfg. No.	Type	Harness Size	Price /Each
SGW578	FPRK099Y50	Roofer's Kit	One Size	209.00



# FALL ARREST & RESCUE

## EXOFIT™ X100 COMFORT CONSTRUCTION SAFETY HARNESSES

- Revolving torso adapters
- Equipped with anti-sliding dorsal D-ring pad to help greatly reduce dorsal D-ring slide
- Integrated easy-link SRL adapter helps you quickly and easily connect and disconnect personal SRLs
- Dual-locking quick connect buckles lock to harness webbing and helps prevent adjustments from slipping
- Automatic stand-up D-ring helps to enable efficient dorsal connections
- Low-profile suspension trauma strap design integrated between harness webbing
- Equipped with auto-resetting lanyard keepers to help with fast and easier parking of snap hooks and carabiners
- Connected safety ID (RFID) integrated for simplified inventory, inspection, and record management
- Built with 6000 lbs. polyester webbing, nylon/polyester hybrid comfort padding and robust alloy steel hardware
- Weight distribution system takes weight off your shoulders
- Comfort back pad with U-shaped neck (removable)
- Type: Work Positioning, Fall Arrest
- CSA Class: AP
- Weight Capacity: 310 lbs.
- D-Rings: Back - Side
- Leg Strap Connections: Tongue Buckle
- Chest Strap Connections: Pass-Through/Mating

SGY919



Model No.	Mfg. No.	Size	Price /Each
SGY915	1401040C	Small	525.80
SGY916	1401041C	Medium	525.80
SGY917	1401042C	Large	525.80
SGY918	1401043C	X-Large	525.80
SGY919	1401044C	2X-Large	525.80

## EXOFIT™ X200 COMFORT VEST SAFETY HARNESSES

- Revolving torso adapters
- Equipped with anti-sliding dorsal D-ring pad to help greatly reduce dorsal D-ring slide
- Integrated easy-link SRL adapter helps you quickly and easily connect and disconnect personal SRLs
- Dual-locking quick connect buckles lock to harness webbing and helps prevent adjustments from slipping
- Automatic stand-up D-ring helps to enable efficient dorsal connections
- Low-profile suspension trauma strap design integrated between harness webbing
- Equipped with auto-resetting lanyard keepers to help with fast and easier parking of snap hooks and carabiners
- Connected safety ID (RFID) integrated for simplified inventory, inspection, and record management
- Built with 6000 lbs. polyester webbing, nylon/polyester hybrid comfort padding and robust alloy steel hardware
- Weight distribution system takes weight off your shoulders
- Comfort back pad with U-shaped neck (removable)
- Weight Capacity: 310 lbs.
- Leg Strap Connections: Quick-Connect
- Chest Strap Connections: Quick-Connect

SGY980



Model No.	Mfg. No.	CSA Class	Size	D-Rings	Price /Each
<b>FALL ARREST</b>					
SGY980	1402020C	A	Small	Back	421.30
SGY981	1402021C	A	Medium	Back	421.30
SGY982	1402022C	A	Large	Back	421.30
SGY983	1402023C	A	X-Large	Back	421.30
SGY984	1402024C	A	2X-Large	Back	421.30

Model No.	Mfg. No.	CSA Class	Size	D-Rings	Price /Each
<b>WORK POSITIONING, LADDER CLIMBING, FALL ARREST</b>					
SGY995	1402050C	ALP	Small	Back - Front - Side	481.80
SGY996	1402051C	ALP	Medium	Back - Front - Side	481.80
SGY997	1402052C	ALP	Large	Back - Front - Side	481.80
SGY998	1402053C	ALP	X-Large	Back - Front - Side	481.80
SGY999	1402054C	ALP	2X-Large	Back - Front - Side	481.80



## EXOFIT™ X300 COMFORT SAFETY HARNESSES

- Revolving torso adapters
- Equipped with anti-sliding dorsal D-ring pad to help greatly reduce dorsal D-ring slide
- Integrated easy-link SRL adapter helps you quickly and easily connect and disconnect personal SRLs
- Auto-locking quick connect buckles secure contact with webbing, helping reduce the need to readjust
- Automatic stand-up D-ring helps to enable efficient dorsal connections
- Low-profile suspension trauma strap design integrated between harness webbing
- Equipped with auto-resetting lanyard keepers to help with fast and easier parking of snap hooks and carabiners
- Connected safety ID (RFID) integrated for simplified inventory, inspection, and record management
- Built with 6000 lbs. polyester webbing, robust nylon/polyester hybrid comfort padding with reflective 3M™ Scotchlite™ panels and lightweight aluminum hardware
- Weight distribution system takes weight off your shoulders
- Comfort back pad with built-in durable shoulder caps
- Weight Capacity: 310 lbs.
- Leg Strap Connections: Quick-Connect
- Chest Strap Connections: Quick-Connect

SGZ103



SGZ141



Model No.	Mfg. No.	CSA Class	Size	D-Rings	Price /Each
<b>FALL ARREST</b>					
SGZ103	1113001C	A	Small	Back	526.44
SGZ104	1113004C	A	Medium	Back	526.44
SGZ105	1113007C	A	Large	Back	526.44
SGZ106	1113010C	A	X-Large	Back	526.44
SGZ107	1113013C	A	2X-Large	Back	526.44

Model No.	Mfg. No.	CSA Class	Size	D-Rings	Price /Each
<b>WORK POSITIONING, FALL ARREST</b>					
SGZ141	1113121C	AP	Small	Back - Side	671.96
SGZ142	1113124C	AP	Medium	Back - Side	671.96
SGZ143	1113127C	AP	Large	Back - Side	671.96
SGZ144	1113130C	AP	X-Large	Back - Side	671.96
SGZ145	1113133C	AP	2X-Large	Back - Side	671.96



## DELTA™ HARNESSES

- Patented triangular no-tangle design creates a frame that allows the harness to fall into place when donned
- Repel™ webbing is water repellent to reduce the attraction of mold and dirt, and has more abrasion resistance
- Revolver™ vertical torso adjusters eliminate loose ends and lock into place, preventing slippage
- Lanyard keepers hold your unused snap hooks and help reduce trip hazards
- Spring-loaded stand-up dorsal D-ring
- Impact indicators provide a visual alert that the harness has been involved in a fall
- Vest style harnesses are the most universal, and are used across a wide variety of industries
- Construction style harnesses have excellent tool-carrying capability, a sewn in hip pad, and a removable body belt
- Cross-over style harnesses have a front-mounted D-ring, making them ideal for ladder climbing and rescue applications
- Weight capacity: 420 lbs (190 kg)
- Certified to CSA standard Z259.10



SEB399



Order No.	Mfg. No.	D-Rings	Leg Connections	Size	CSA Class	Price /Each
<b>VEST</b>						
SEB391	1110600C	Back	Quick-Connect	Universal	A	274.00
SEB406	1102000C	Back	Tongue Buckle	Universal	A	227.00
SEB403	1103321C	Back	Pass-Thru	Universal	A	214.00
SEB401	1102008C	Back and Side	Tongue Buckle	Universal	A, P	246.00
SEB392	1110602C	Back and Shoulder	Quick-Connect	Universal	A, E	288.00
SEP796	1102090C	Back and Front	Quick-Connect	Universal	A, D, L	334.00
<b>CONSTRUCTION</b>						
SEB397	1102201C	Back and Side	Tongue Buckle	Small	A, P	442.00
SEB398	1101654C	Back and Side	Tongue Buckle	Medium	A, P	442.00
SEB399	1101655C	Back and Side	Tongue Buckle	Large	A, P	442.00
SEB400	1101656C	Back and Side	Tongue Buckle	X-Large	A, P	442.00
SEB418	1102526C	Back	Tongue Buckle	Universal	A	254.00
<b>CROSS-OVER</b>						
SEB402	1102010C	Back and Front	Pass-Thru	Universal	A, D, L	237.00
SEB405	1103270C	Back, Front and Side	Pass-Thru	Universal	A, D, L, P	246.00

## EXOFIT NEX™ ROPE ACCESS & RESCUE HARNESSES

- Ideal for professionals performing rescue and emergency services, industrial rope access and rigging, wind energy and tower maintenance, as well as arborist activities
- Combines specialized designs, components and hardware to optimize rope rescue and industrial rope access work
- Soft, lightweight, water repellent webbing reduces attraction of mold and dirt and has up to 5 times more abrasion resistance
- Spring-loaded stand-up dorsal D-ring with impact indicator
- Comfortable design dons without tangling
- Duo-Lok™ quick-connect buckles provide one-handed operation
- Revolver™ vertical torso adjusters eliminate loose ends and lock into place
- Tech-Lite™ aluminum D-Rings
- Lightweight, moisture wicking, breathable hybrid comfort padding won't move or slip
- Soft edging moves with you, preventing uncomfortable rubbing or chafing
- Molded lanyard keepers prevent dangerous entanglements
- Shoulder caps provide protection and comfort when carrying heavy materials
- Reflective piping enhances visibility in low-light conditions
- Built-in carrying pocket conveniently protects a cell phone, camera, or other items
- Integrated trauma straps help minimize suspension trauma post fall
- i-Safe™ enabled providing the ability to track inspections, control inventory and manage information
- Weight capacity: 420 lbs (190 kg)
- Certified to CSA standard Z259.10



SE5066



Model No.	Mfg. No.	Size	CSA Class	Price /Each
SE5066	1113345C	Small	A, D, L, P	608.83
SEP874	1113346C	Medium	A, D, L, P	608.83
SER775	1113347C	Large	A, D, L, P	608.83
SER779	1113348C	X-Large	A, D, L, P	608.83

## FULL-BODY HARNESSES

- Fixed D-ring reduces the need for readjustment throughout the workday
- Modern design gives the harness a fresh and sleek look
- Auto-resetting lanyard keeps for fast and easy parking of snap hooks and carabiners
- Impact indicators make it easy to inspect the harness for prior damaging impact loads
- Protected labels for long-term identification and inspection
- Weight Capacity: 420 lbs.
- Certified to CSA standard Z259.10
- Size: Medium/Large



Model No.	Mfg. No.	Style	D-Rings	Leg Connections	CSA Class	Price /Each
SG1641	1161571C	Vest-Style	Back	Pass-Thru	A	94.64
SGH427	1161542C	Vest-Style	Back	Pass-Thru	A	107.64
SGJ061	1161525C	Vest-Style	Back	Quick Connect	A	170.56
SG1148	1161309C	Construction Style Positioning	Back, Side	Tongue Buckle	A, P	206.96
SGJ065	1161529C	Vest-Style Retrieval	Back, Shoulder	Quick Connect	A, E	253.76

\* Available in other sizes, styles and configurations

# FALL ARREST & RESCUE

## H500 CONSTRUCTION COMFORT FULL BODY HARNESSES

- Quick and easy-to-fit and adjust
- Improved visible stitch pattern
- Clearly identifiable fall-impact indicators
- Highly breathable, lightweight, ergonomic shoulder/back padding
- Robust and ergonomic pressure-relief waist pad
- Specially formulated, comfortable leg and shoulder webbing
- User-friendly lanyard keepers
- Type: Work Positioning, Ladder Climbing, Descent Control, Fall Arrest
- CSA Class: ADLP
- Weight Capacity: 420 lbs.
- D-Rings: Back - Front - Side



**Honeywell**  
**MILLER**

Model No.	Mfg. No.	Size	Leg Strap Connections	Chest Strap Connections	D-Ring Material	Price /Each
SGV737	H5CC221121	Small, Medium	Quick-Connect	Quick-Connect	Steel	271.00
SGV738	H5CC221122	Universal	Quick-Connect	Quick-Connect	Steel	271.00
SGV739	H5CC221123	2X-Large	Quick-Connect	Quick-Connect	Steel	271.00
SGV731	H5CC222221	Small, Medium	Quick-Connect	Quick-Connect	Aluminum	317.00
SGV732	H5CC222222	Universal	Quick-Connect	Quick-Connect	Aluminum	317.00
SGV733	H5CC222223	2X-Large	Quick-Connect	Quick-Connect	Aluminum	317.00
SGV725	H5CC311121	Small, Medium	Tongue Buckle	Pass-Through/Mating	Steel	266.00
SGV726	H5CC311122	Universal	Tongue Buckle	Pass-Through/Mating	Steel	266.00
SGV727	H5CC311123	2X-Large	Tongue Buckle	Pass-Through/Mating	Steel	266.00

## H500 INDUSTRY COMFORT FULL BODY HARNESSES

- Quick and easy-to-fit and adjust
- Improved visible stitch pattern
- Clearly identifiable fall-impact indicators
- Highly breathable, lightweight, ergonomic shoulder/back padding
- Specially formulated, comfortable leg and shoulder webbing
- User-friendly lanyard keepers
- Type: Fall Arrest
- CSA Class: A
- Weight Capacity: 420 lbs.
- D-Rings: Back



**Honeywell**  
**MILLER**

Model No.	Mfg. No.	Size	Leg Strap Connections	Chest Strap Connections	D-Ring Material	Price /Each
SGV755	H5IC221001	Small, Medium	Quick-Connect	Quick-Connect	Steel	202.00
SGV756	H5IC221002	Universal	Quick-Connect	Quick-Connect	Steel	202.00
SGV757	H5IC221003	2X-Large	Quick-Connect	Quick-Connect	Steel	202.00
SGV752	H5IC311001	Small, Medium	Tongue Buckle	Pass-Through/Mating	Steel	174.00
SGV753	H5IC311002	Universal	Tongue Buckle	Pass-Through/Mating	Steel	174.00
SGV754	H5IC311003	2X-Large	Tongue Buckle	Pass-Through/Mating	Steel	174.00

## H500 INDUSTRY STANDARD FULL BODY HARNESSES

- Quick and easy-to-fit and adjust
- Improved visible stitch pattern
- Clearly identifiable fall-impact indicators
- Smart anti-tangle easy-donning solution
- Specially formulated, comfortable leg and shoulder webbing
- User-friendly lanyard keepers
- Soft, removable shoulder pads
- Type: Fall Arrest
- CSA Class: A
- Weight Capacity: 420 lbs.
- D-Rings: Back



**Honeywell**  
**MILLER**

Model No.	Mfg. No.	Size	Leg Strap Connections	Chest Strap Connections	D-Ring Material	Price /Each
SGV770	H5ISP311001	Small, Medium	Tongue Buckle	Pass-Through/Mating	Steel	138.00
SGV771	H5ISP311002	Universal	Tongue Buckle	Pass-Through/Mating	Steel	138.00
SGV772	H5ISP311003	2X-Large	Tongue Buckle	Pass-Through/Mating	Steel	138.00
SGV776	H5ISP221001	Small, Medium	Quick-Connect	Quick-Connect	Steel	171.00
SGV777	H5ISP221002	Universal	Quick-Connect	Quick-Connect	Steel	164.00
SGV778	H5ISP221003	2X-Large	Quick-Connect	Quick-Connect	Steel	171.00

## H700 SERIES PREMIUM FULL BODY HARNESSES

- Features a patented release mechanism for quick-deployment of two One-Pull Trauma Relief Steps (one per foot) to relieve pressure being applied to the arteries and veins around the top of the leg, avoiding the risk of serious injury or death
- Configurable leg strap design features new Pivot Strap Adjustors to allow workers to adjust the shape of the leg straps depending on the action that needs to be performed
- Low-profile, modular, lightweight accessory straps for accommodate a large number of accessories and allow workers to conveniently attach and move pouches around the MOLLE strap
- The convenient Self-Retracting Lifeline (SRL) integrated connector allows for easy attachment of personal single/twin SRLs and carabiners
- Tool tether anchors and lanyard keepers are positioned in several convenient locations, including front and waist
- This lightweight full body harness offers workers at height less heft, more comfort, and easier mobility
- Innovative, multi-layered padding has been designed for enhanced breathability and venting, keeping workers drier and cooler by combining airflow channel breathability, moisture dispersion technology, and 3D knitted fabric
- Shoulder back padding has also been designed to protect workers from the robust twin personal SRLs
- Shoulder back padding can be removed if needed for cleaning purposes
- Weight Capacity: 420 lbs.
- D-Ring Material: Aluminum
- Additional Standard(s) Met: OSHA 1926.502, ANSI Z359.11-2021, & CSA Z259.10



**Honeywell**  
**MILLER**

Model No.	Mfg. No.	Size	D-Rings	Leg Strap Connections	Chest Strap Connections	Price /Each
<b>WORK POSITIONING, FALL ARREST, CSA CLASS AP, VARIANT CC2 (CONSTRUCTION COMFORT 2)</b>						
SHA888	H7CC2A1	Small, Medium	Back - Side	Tongue Buckle	Quick-Connect	756.00
SHA889	H7CC2A2	Universal	Back - Side	Tongue Buckle	Quick-Connect	756.00
SHA890	H7CC2A3	2X-Large	Back - Side	Tongue Buckle	Quick-Connect	756.00
<b>FALL ARREST, CSA CLASS A, VARIANT IC1 (INDUSTRY COMFORT 1)</b>						
SHA903	H7IC1A1	Small, Medium	Back	Quick-Connect	Quick-Connect	645.00
SHA904	H7IC1A2	Universal	Back	Quick-Connect	Quick-Connect	645.00
SHA905	H7IC1A3	2X-Large	Back	Quick-Connect	Quick-Connect	645.00
<b>WORK POSITIONING, LADDER CLIMBING, DESCENT CONTROL, FALL ARREST, CSA CLASS ADLP, VARIANT IC3 (INDUSTRY COMFORT 3)</b>						
SHA917	H7IC3A1	Small, Medium	Back - Front - Side	Quick-Connect	Quick-Connect	700.00
SHA918	H7IC3A2	Universal	Back - Front - Side	Quick-Connect	Quick-Connect	700.00
SHA919	H7IC3A3	2X-Large	Back - Front - Side	Quick-Connect	Quick-Connect	700.00

## H100 HARNESS

- Meets the most common fall protection needs while maintaining a focus on value and safety
- Covering protects the identification label during the life of the harness
- Lightweight and more comfortable
- Visible distinctive colour
- Features Honeywell logo and label
- Self-contained, practical Velcro® brand label pouch
- Fall indicator
- Plastic back pad/D-ring protector
- Sub-pelvic strap and lanyard keepers
- Meets applicable ANSI Z359.11-2014, OSHA 1910.140, OSHA 1926.502 standards
- Type: Fall Arrest
- Weight Capacity: 420 lbs.
- D-Rings: Back
- Chest Strap Connections: Pass-Through/Mating
- Back D-Ring Material: Steel
- Webbing: 1-3/4" Polyester

SHA924



**Honeywell**  
**MILLER**

Model No.	Mfg. No.	Size	CSA Class	Leg Strap Connection	Weight	Price /Each
SHA921	H13110021	Small, Medium	A	Tongue Buckle	2.65 lbs.	82.80
SHA922	H13110022	Universal	A	Tongue Buckle	3.22 lbs.	82.80
SHA923	H13110023	2X-Large, 3X-Large	A	Tongue Buckle	3.33 lbs.	82.80
SHA924	H11110021	Small, Medium	A	Pass-Through/Mating	2.45 lbs.	67.80
SHA925	H11110022	Universal	A	Pass-Through/Mating	2.54 lbs.	67.70
SHA926	H11110023	2X-Large, 3X-Large	A	Pass-Through/Mating	2.98 lbs.	67.80

## MILLER® AIRCORE™ HARNESSES

- Designed with breathable, open-core padding technology that provides optimal air flow, while reducing heat and moisture entrapment, keeping a worker drier and cooler
- Patented Miller DuraFlex® stretchable webbing provides greater flexibility and increased comfort
- Easy adjustment with cam buckles on shoulder straps
- Contoured ergonomic padding design minimizes contact around a worker's neck, lower back, and inner thighs to reduce chaffing and irritation
- Stand-up back D-ring
- Quick-connect chest strap buckles for easy donning
- Lightweight materials and components reduce fatigue for all-day endurance and increased productivity
- Durable knitted mesh back shield minimizes moisture absorption and maintains optimal air circulation
- Weight capacity: 400 lbs. (181.4 kg)
- Certified to CSA standard Z259.10

SEJ644



SEJ647



**Honeywell**  
**MILLER**

Model No.	Mfg. No.	D-Rings	Leg Connections	Additional Features	CSA Class	Price /Each
<b>STEEL HARDWARE</b>						
SEJ643	AC-TB-D/UGN	Back and Side	Tongue Buckle	-	A, P	635.00
SEJ644	AC-TB-BDP/UGN	Back and Side	Tongue Buckle	Lumbar Pad and Removable Belt	A, P	662.00
SEJ645	AC-QC/UGN	Back	Quick Connect	-	A	501.00
SEJ646	AC-QC-D/UGN	Back and Side	Quick Connect	-	A, P	611.00
SEJ647	AC-QC-BDP/UGN	Back and Side	Quick Connect	Lumbar Pad and Removable Belt	A, P	608.00
<b>ALUMINUM HARDWARE</b>						
SEJ648	ACA-TB/UGN	Back	Tongue Buckle	-	A	658.00
SEJ649	ACA-TB-D/UGN	Back and Side	Tongue Buckle	-	A, P	846.00
SEJ650	ACA-TB-BDP/UGN	Back and Side	Tongue Buckle	Lumbar Pad and Removable Belt	A, P	814.00
SEJ651	ACA-QC/UGN	Back	Quick Connect	-	A	672.00
SEJ652	ACA-QC-D/UGN	Back and Side	Quick Connect	-	A, P	769.00

## MILLER® REVOLUTION™ HARNESSES

- Donning made easy with two-sided Dualtech™ webbing with contrasting colours and textures
- Easy, one-hand cam buckle adjustment/release allows simultaneous adjustment of shoulder straps
- Web finials clip-on design safely organises webbing after proper adjustment
- ErgoArmor™ semi-flexible back shield minimises impact from sharp/heavy snap hooks and self-retracting lifelines
- PivotLink™ hip connections unique rotary design provides greater comfort in bending/mobility
- Integrated pack encapsulates labels minimising damage and loss
- Integrated accessory system with modular attachment design provides connection points for belts/tools/accessories
- Weight capacity: 400 lbs. (181.4 kg)
- Certified to CSA standard Z259.10

SAN124



MILLER  
**REVOLUTION**  
HARNESS



**Honeywell**  
**MILLER**

Model No.	Mfg. No.	D-Rings	Leg Connections	Removable Belt	CSA Class	Price /Each
SAN124	RDT-QC/UBKC	Back	Quick-Connect	No	A	557.00
SAN125	RDT-TB/UBKC	Back	Tongue Buckle	No	A	610.00
SAN126	RDT-QC-B/UBKC	Back	Quick-Connect	Yes	A	686.00
SAN130	RDT-QC-BDP/UBKC	Back, Side	Quick-Connect	Yes	A, P	800.00



# FALL ARREST & RESCUE

## V-FIT™ FULL BODY HARNESS

- Using a patent-pending RaceFlex™ connection, webbing is routed across the chest for a secure and comfortable fit
- The RaceFlex™ Buckle creates an athletic cut, contouring the harness to the body and improving upper torso movement on the job
- Shoulder padding responds to your movement to conform to your body, eliminating pressure points and chafing, and can be removed for cleaning
- Patented leg strap design keeps leg straps in place as webbing lays horizontally across the thighs, creating a more natural fit
- Pull-down adjustment allows you to quickly and easily get the right fit that lasts throughout the work day
- Dedicated attachment point for personal fall limiters allows for quick and easy attachment, and keeps your back D-ring free for other use
- Weight Capacity: 400 lbs.
- Chest Strap Connections: Quick-Connect
- Standards Met: ANSI Z359.11, CSA Z259.10 & OSHA



SGT740



Model No.	Mfg. No.	Type	CSA Class	Size	D-Rings	Leg Strap Connections	Price /Each
SGT740	10194890	Fall Arrest	A	X-Large	Back - Side	Tongue Buckle	479.00
SGT736	10194909	Fall Arrest, Work Positioning	AP	Medium, Large	Back - Side	Tongue Buckle	501.00
SGT737	10194910	Fall Arrest, Work Positioning	AP	X-Large	Back - Side	Tongue Buckle	501.00
SGT734	10194873	Fall Arrest, Work Positioning	AP	Medium, Large	Back - Side	Quick-Connect	501.00
SGT735	10194874	Fall Arrest, Work Positioning	AP	X-Large	Back - Side	Quick-Connect	501.00

## V-FIT™ CONSTRUCTION FULL BODY HARNESS

- Adjustable waist pad allows you to position the waist pad specifically task
- Patent pending design V-Fit™ waist pad can be adjusted higher on the torso for lumbar support or lower for work positioning applications
- Designed around pressure points and by choosing breathable materials, the V-FIT waist pad delivers ultimate on-the-job comfort
- Using a patent-pending RaceFlex™ connection, webbing is routed across the chest for a secure and comfortable fit
- The RaceFlex™ Buckle creates an athletic cut, contouring the harness to the body and improving upper torso movement on the job
- Shoulder padding responds to your movement to conform to your body, eliminating pressure points and chafing, and can be removed for cleaning
- Patented leg strap design keeps leg straps in place as webbing lays horizontally across the thighs, creating a more natural fit
- Pull-down adjustment allows you to quickly and easily get the right fit that lasts throughout the work day
- Dedicated attachment point for personal fall limiters allows for quick and easy attachment, and keeps your back D-ring free for other use
- Type: Fall Arrest, Work Positioning
- Weight Capacity: 400 lbs.
- D-Rings: Back - Side



SGT726



Model No.	Mfg. No.	CSA Class	Size	D-Rings	Leg Strap Connections	Chest Strap Connections	Price /Each
SGT726	10195133	AP	X-Small	Back - Side	Quick-Connect	Quick-Connect	650.00
SGT728	10195134	AP	Medium, Large	Back - Side	Quick-Connect	Quick-Connect	639.00
SGT729	10195135	AP	X-Large	Back - Side	Quick-Connect	Quick-Connect	639.00
SGT727	10195136	AP	2X-Large	Back - Side	Quick-Connect	Quick-Connect	650.00
SGT730	10195148	AP	X-Small	Back - Side	Tongue Buckle	Quick-Connect	639.00
SGT732	10195150	AP	X-Large	Back - Side	Tongue Buckle	Quick-Connect	639.00
SGT733	10195151	AP	2X-Large	Back - Side	Tongue Buckle	Quick-Connect	639.00
SGT731	10195149	AP	Medium, Large	Back - Side	Tongue Buckle	Quick-Connect	639.00

## V-FORM™ SAFETY FULL BODY HARNESS

- The patent-pending RaceForm™ buckle allows for a close, comfortable harness fit, eliminating the need for bulky chest straps or cumbersome buckles
- The RaceForm™ buckle creates an athletic cut, contouring the harness to the body and improving upper torso movement on the job
- Pull-down adjustment allows you to quickly and easily get the right fit that lasts throughout the work day
- Weight Capacity: 400 lbs.



SGP532



SGP540



Model No.	Mfg. No.	Type	CSA Class	Size	D-Rings	Leg Strap Connections	Chest Strap Connections	Price /Each
SGP532	10197195	Fall Arrest	A	X-Small	Back	Pass-Through/Mating	Quick-Connect	74.60
SGP533	10197196	Fall Arrest	A	Medium, Large	Back	Pass-Through/Mating	Quick-Connect	74.60
SGP534	10197197	Fall Arrest	A	X-Large	Back	Pass-Through/Mating	Quick-Connect	77.10
SGP535	10197198	Fall Arrest	A	2X-Large	Back	Pass-Through/Mating	Quick-Connect	77.10
SGP536	10196702	Fall Arrest	A	X-Small	Back	Tongue Buckle	Quick-Connect	96.10
SGP530	10196642	Fall Arrest	A	Medium, Large	Back	Tongue Buckle	Quick-Connect	96.10
SGP537	10197160	Fall Arrest	A	X-Large	Back	Tongue Buckle	Quick-Connect	97.20
SGP538	10197201	Fall Arrest	A	2X-Large	Back	Tongue Buckle	Quick-Connect	97.20
SGP529	10197200	Fall Arrest, Work Positioning	AP	Medium, Large	Back - Side	Pass-Through/Mating	Quick-Connect	90.60
SGP540	10197219	Evacuation/Retrieval, Fall Arrest	AE	Medium, Large	Back - Shoulder	Tongue Buckle	Quick-Connect	144.00
SGP531	10197215	Fall Arrest, Work Positioning	AP	Medium, Large	Back - Side	Tongue Buckle	Quick-Connect	110.00

## EVOTECH® ARC FLASH HARNESSSES

- Reflectivity on shoulder padding provides increased visibility in low-light applications
- Moisture-wicking padding keeps users cool
- 100% Kevlar webbing is fire-resistant and self-extinguishing
- Lighter than comparable harnesses
- Padded shoulders
- Weight Capacity: 400 lbs.
- Chest Strap Connections: Quick-Connect



Model No.	Mfg. No.	D-Rings	Leg Strap Connections	Size	CSA Class	Price /Each
SGE629	10150156	Back	Pass-Through	Universal	A	802.00
SGE630	10150144	Back	Quick-Connect	Universal	A	846.00
SGE631	10150145	Back	Quick-Connect	X-Large	A	852.00
SGE632	10155824	Back/Side	Pass-Through	Universal	A,P	824.00
SGE633	10150152	Back/Side	Quick-Connect	Universal	A,P	857.00
SGE634	10150153	Back/Side	Quick-Connect	X-Large	A,P	868.00

SGE629



## V-FLEX® FULL-BODY SAFETY HARNESS

- Using a patent-pending RaceFLEX connection, webbing is routed across the chest for a secure and comfortable fit—eliminating the need for bulky chest straps or cumbersome buckles
- Reduce fatigue with flexible foam shoulder pad that responds to your movement to conform to your body, eliminating pressure points and chafing
- Keep cool and reduce heat stress with interior padding designed with channels for continuous air flow and ventilation
- Using an exclusive racing style design, webbing contours to the torso, reducing the need for adjustments throughout the day and allowing for better mobility on the job
- Featuring a patent-pending hip connection, the harness "flexes" with the worker, reducing fatigue throughout the day
- Pull down adjustment allows you to quickly and easily get the right fit that last throughout the work day
- Closed cell foam reduces moisture build-up – keeping your pad from getting soggy and extending the life of your harness
- Vented "V" feature allows for fresh air to flow from outside the pad, to inside
- Type: Fall Arrest • CSA Class: A
- D-Rings: Back
- Chest Strap Connections: Quick-Connect
- Standard(s) Met: ANSI Z359.11, CSA Z259.5, OSHA

SGH484



Model No.	Mfg. No.	Weight Capacity	Size	Leg Strap Connections	Price /Each
SHG485	10239822	150 lbs.	X-Small	Quick-Connect	713.00
SHG484	10239740	230 lbs.	Regular	Quick-Connect	713.00
SHG486	10239981	300 lbs.	X-Large	Quick-Connect	713.00
SHG487	10239982	400 lbs.	2X-Large	Quick-Connect	713.00
SHG488	10239983	150 lbs.	X-Small	Tongue Buckle	713.00
SHG489	10239984	230 lbs.	Regular	Tongue Buckle	713.00
SHG490	10239985	300 lbs.	X-Large	Tongue Buckle	713.00
SHG491	10239986	400 lbs.	2X-Large	Tongue Buckle	713.00

## GRAVITY® WELDER HARNESSSES

- Made of 100% Kevlar webbing
- Performs very well in high heat and welding applications
- CSA Class: A
- Weight Capacity: 400 lbs.
- D-Rings: Back
- Leg Strap Connections: Pass-Through
- Chest Strap Connections: Pass-Through

SGE639



Model No.	Mfg. No.	Size	Price /Each
SGE639	10103216	Universal	546.00
SGE640	10103217	X-Large	557.00

## GRAVITY® FULL BODY SUSPENSION HARNESS

- Premium hardware fittings with wide opening aluminum D-rings, triple action carabiner, and single hand adjusting buckles
- Five rigid tool loops on the waist belt and leg connections
- Bayonet buckles with locking engagement window confirms a secure connection
- Strategically positioned ventral attachment distributes the load between the waist belt and leg loops during suspension
- Breathable waist pad is constructed from a multi-layered padding which dissipates pressure from the webbing to reduce fatigue when working for long periods of time
- Rolled-edge shoulder padding protects the neck from chafing while providing the necessary back support
- Type: Descent Control, Evacuation/Retrieval, Fall Arrest, Ladder Climbing, Work Positioning
- CSA Class: ADELP
- Weight Capacity: 400 lbs.
- D-Rings: Back - Front - Shoulder - Side
- Leg Strap Connections: Quick-Connect
- Chest Strap Connections: None
- Colour: Green

SGT225



Model No.	Mfg. No.	Size	Price /Each
SGT225	10150453	Small	580.00
SGT226	10150454	Medium	580.00
SGT227	10150455	Large	580.00



# FALL ARREST & RESCUE

## SHOCKWAVE™ 2 SHOCK ABSORBING LANYARDS

- Tubular core style lanyards uniquely designed to expand and contract in reaction to a workers movements
- Stays out of your way when not in use, avoiding trips and snags
- Built in impact indicator provides visual evidence if the lanyard has been involved in a fall
- Length: 6'
- Certification(s): CSA Standard Z259.11



SEB868



Fall Protection

Model No.	Mfg. No.	No. of Legs	Harness Connection	Anchorage Connections	CSA Mass lbs. min.	max.	Price /Each
SEB868	1244306C	One	Snap Hook	Snap Hook	133	253	204.75

## PRO™ PACK SHOCK ABSORBING LANYARDS

- Pack-type shock absorber limits fall arrest forces to 900 lbs. for added safety
- Durable 1" polyester web construction
- Durable alloy steel, zinc-plated hardware
- Harness Connection: Snap Hook
- Certification(s): CSA Standard Z259.11



SEB872

SEB384



Fall Protection

Model No.	Mfg. No.	Length'	No. of Legs	Anchorage Connections	CSA Mass lbs. min.	max.	Price /Each
SEB871	1341004C	4	One	Snap Hook	122	308	107.12
SEB872	1341001C	6	One	Snap Hook	122	308	105.58
SEB384	1340125C	6	One	Gate Hook	122	308	144.20

## WEB ADJUSTABLE POSITIONING LANYARD

- 6 ft. (1.8m) adjustable single-leg lanyard
- Ideal for work positioning or restraint
- Abrasion resistant polyester webbing
- Built-in wear indicator
- User friendly self locking snap hooks at each end
- Equipped with i-Safe™
- CSA standard Z259.11, Class B



Fall Protection

Model No.	Mfg. No.	No. of Legs	Harness Connection	Anchorage Connection	Price /Each
SEP822	1231016C	One	Snap Hook	Snap Hook	144.90

## EZ-STOP™ SHOCK ABSORBING LANYARDS

- Features the lightest, smallest, and strongest shock absorber in the world; 66% smaller and 40% lighter than previous EZ-Stop™ models
- Lightest and strongest rebar hooks on the market
- Thinnest-ever webbing using HI-10™ Vectran® energy management material for reduced weight and bulk
- Vectran® is a multifilament high tenacity performance fibre spun from liquid crystal polymer that is five times stronger than steel
- Repel™ webbing repels water to reduce the attraction of mold and dirt
- High abrasion resistance
- Excellent chemical and cut resistance
- High impact resistance
- High visibility accents keep you safe in low-light conditions
- Protected labels for durability and longevity
- Rugged and durable soft shock absorber cover is designed to last
- Certification(s): CSA Standard Z259.11



SEJ419

SEJ423



Fall Protection

Model No.	Mfg. No.	Length'	No. of Legs	Harness Connection	Anchorage Connections	CSA Mass lbs. min.	max.	Price /Each
SEJ418	1246012C	3	One	Snap Hook	Snap Hook	122	308	171.00
SEJ419	1246017C	4	One	Snap Hook	Snap Hook	122	308	191.00
SEJ421	1246102C	6	One	Snap Hook	Rebar Hook	122	308	288.00
SEJ422	1246022C	6	Two	Snap Hook	Snap Hooks	122	308	321.00
SEJ423	1246024C	6	Two	Snap Hook	Rebar Hooks	122	308	492.00

## PRO™ PACK HOT WORK SHOCK ABSORBING LANYARD

- Lightweight user friendly design
- Fire resistant Kevlar® fiber webbing
- PVC shock pack with Kevlar® cover
- Energy absorbing design limits fall arrest forces
- User friendly self locking snap hooks at each end
- Impact indicator
- Harness Connection: Snap Hook
- Certification(s): CSA Standard Z259.11



SDP386



Fall Protection

Model No.	Mfg. No.	Length'	No. of Legs	Anchorage Connections	CSA Mass lbs. min.	max.	Price /Each
SDP386	1340129C	6	One	Rebar Hook	122	308	219.39
SDP388	1340186C	4	Two	Rebar Hooks	122	308	349.17

## SUSPENSION TRAUMA SAFETY STRAPS

- They are deployed when needed, hook together in seconds, and let a suspended worker stand up in harness, relieving downward pressure
- You can quickly attach them to most harness brands right in the field
- Compact, lightweight design stays out of your way
- Weight capacity: 310 lbs. (141 kg)
- Sold per pair



Fall Protection

Model No.	Mfg. No.	Price /Each
SEB436	9501403C	43.58



## TITAN™ SHOCK-ABSORBING LANYARD

- Material: Polyester
- Shock Absorber Type: Pack
- Colour: Orange
- CSA Minimum Mass: 120 lbs.
- CSA Maximum Mass: 335 lbs.
- Certification(s): CSA Standard Z259.11

**Honeywell**  
**MILLER**



Model No.	Mfg. No.	Length'	No. of Legs	Harness Connection	Anchorage Connection	Price /Each
SGT479	T1SSSR-054C	4	One	Locking Snap Hook	Locking Rebar Hook	111.00
SGT473	T1SSSR-056C	6	One	Locking Snap Hook	Locking Rebar Hook	125.00
SGT487	T1SSSS-053C	3	One	Locking Snap Hook	Locking Snap Hook	109.00
SGT474	T1SSSS-054C	4	One	Locking Snap Hook	Locking Snap Hook	78.10
SGT472	T1SSSS-056C	6	One	Locking Snap Hook	Locking Snap Hook	107.00
SGT494	T2SSSR-056C	6	Two	Locking Snap Hook	Locking Rebar Hook	268.00
SGT484	T2SSSS-056C	6	Two	Locking Snap Hook	Locking Snap Hook	261.00

## MILLER® HP™ LANYARD WITH SOFSTOP® SHOCK ABSORBER

- Features a heavy-duty back-up safety strap
- SofStop® Energy Absorber pack is designed with a specially-woven inner core that smoothly expands to reduce fall arrest forces
- Connectors' Gate Load Capacity: 3600 lbs.
- Material: Polyester
- Shock Absorber Type: Pack
- Colour: Green
- CSA Minimum Mass: 120 lbs.
- CSA Maximum Mass: 335 lbs.
- Certification(s): CSA Standard Z259.11

**Honeywell**  
**MILLER**



Model No.	Mfg. No.	Length'	No. of Legs	Harness Connection	Anchorage Connection	Price /Each
SGT535	M1FSFC-WS4C	4	One	Locking Snap Hook	Scaffold Hook	289.00
SGT499	M1FSFC-WS6C	6	One	Locking Snap Hook	Scaffold Hook	271.00
SGT482	M1FSFR-WS4C	4	One	Locking Snap Hook	Locking Rebar Hook	192.00
SGT486	M1FSFR-WS6C	6	One	Locking Snap Hook	Locking Rebar Hook	221.00
SGT492	M1FSFS-WS4C	4	One	Locking Snap Hook	Locking Snap Hook	172.00
SGT476	M1FSFS-WS6C	6	One	Locking Snap Hook	Locking Snap Hook	177.00
SGT507	M2FSFC-WS4C	4	Two	Locking Snap Hook	Scaffold Hook	341.00
SGT520	M2FSFC-WS6C	6	Two	Locking Snap Hook	Scaffold Hook	513.00
SGT485	M2FSFR-WS4C	4	Two	Locking Snap Hook	Locking Rebar Hook	253.00
SGT511	M2FSFR-WS6C	6	Two	Locking Snap Hook	Locking Rebar Hook	361.00
SGT496	M2FSFS-WS4C	4	Two	Locking Snap Hook	Locking Snap Hook	273.00
SGT510	M2FSFS-WS6C	6	Two	Locking Snap Hook	Locking Snap Hook	351.00

## MILLER® BACKBITER® TIE-BACK LANYARD

- All-in-one lanyard with SofStop® Energy Absorber and cross-arm anchorage connector
- SofStop® Energy Absorber pack is designed with a specially-woven inner core that smoothly expands to reduce fall arrest forces
- Heavy-duty polyester webbing and Cordura® nylon webbing with increased abrasion resistance
- Designed from top to bottom for tie-back use with the anchorage connector Miller 5K® Snap Hook
- Harness Connector Gate Load Capacity: 3600 lbs.
- Anchorage Connector Gate Load Capacity: 5000 lbs.
- Material: Nylon, Polyester
- Shock Absorber Type: Pack
- Colour: Green
- CSA Minimum Mass: 120 lbs.
- CSA Maximum Mass: 335 lbs.
- Certification(s): CSA Standard Z259.11

**Honeywell**  
**MILLER**



Model No.	Mfg. No.	Length'	No. of Legs	Harness Connection	Anchorage Connection	Price /Each
SGT475	M1FSTB-AS6C	6	One	Locking Snap Hook	Locking Snap Hook	278.00
SGT547	M2FSTB-AS6C	6	Two	Locking Snap Hook	Locking Snap Hook	633.00

## TITAN™ STRETCH SHOCK-ABSORBING LANYARD

- Material: Polyester
- Shock Absorber Type: Pack
- Colour: Orange
- CSA Minimum Mass: 120 lbs.
- CSA Maximum Mass: 335 lbs.
- Certification(s): CSA Standard Z259.11

**Honeywell**  
**MILLER**



Model No.	Mfg. No.	Length'	No. of Legs	Harness Connection	Anchorage Connection	Price /Each
SGT532	T1SSSS-US6C	6	One	Locking Snap Hook	Locking Snap Hook	244.00
SGT518	T2SSSR-US6C	6	Two	Locking Snap Hook	Locking Rebar Hook	409.00

## MILLER® STRETCHSTOP® LANYARD WITH SOFSTOP® SHOCK ABSORBER

- Features a heavy-duty back-up safety strap
- SofStop® Energy Absorber pack is designed with a specially-woven inner core that smoothly expands to reduce fall arrest forces
- Contracts from 6' (1.8 m) to 4' (1.2 m), greatly reducing the chances of tripping, snagging, or dragging
- Connectors' Gate Load Capacity: 3600 lbs.
- Material: Polyester
- Shock Absorber Type: Pack
- Colour: Green
- CSA Minimum Mass: 120 lbs.
- CSA Maximum Mass: 335 lbs.
- Certification(s): CSA Standard Z259.11

**Honeywell**  
**MILLER**



Model No.	Mfg. No.	Length'	No. of Legs	Harness Connection	Anchorage Connection	Price /Each
SGT534	M1FSFC-TS4C	4	One	Locking Snap Hook	Scaffold Hook	269.00
SGT490	M1FSFC-TS6C	6	One	Locking Snap Hook	Scaffold Hook	310.00
SGT480	M1FSFR-TS4C	4	One	Locking Snap Hook	Locking Rebar Hook	142.00
SGT478	M1FSFR-TS6C	6	One	Locking Snap Hook	Locking Rebar Hook	188.00
SGT483	M1FSFS-TS4C	4	One	Locking Snap Hook	Locking Snap Hook	162.00
SGT509	M1FSFS-TS5C	5	One	Locking Snap Hook	Locking Snap Hook	176.00
SGT477	M1FSFR-TS6C	6	One	Locking Snap Hook	Locking Snap Hook	184.00
SGT501	M2FSFC-TS4C	4	Two	Locking Snap Hook	Scaffold Hook	289.00
SGT515	M2FSFC-TS6C	6	Two	Locking Snap Hook	Scaffold Hook	365.00
SGT491	M2FSFS-TS6C	6	Two	Locking Snap Hook	Locking Snap Hook	276.00

## MILLER® VINYL-COATED SHOCK-ABSORBING LANYARD

- Features a special vinyl coating on the webbing to protect against a variety of liquids that could compromise overall performance
- SofStop® Energy Absorber pack is designed with a specially-woven inner core that smoothly expands to reduce fall arrest forces
- Features a heavy-duty back-up safety strap
- Effective in a wide range of applications, including food processing, petrochemical, water treatment, painting, billboards, and general industry
- Material: Polyester
- Shock Absorber Type: Pack
- Colour: Green
- CSA Minimum Mass: 120 lbs.
- CSA Maximum Mass: 335 lbs.
- Certification(s): CSA Standard Z259.11

**Honeywell**  
**MILLER**



Model No.	Mfg. No.	Length'	No. of Legs	Harness Connection	Anchorage Connection	Price /Each
SGT538	M2FSFC-DS6C	6	Two	Locking Snap Hook	Scaffold Hook	572.00
SGT488	M1FSFS-DS6C	6	One	Locking Snap Hook	Locking Snap Hook	277.00
SGT517	M2FSFS-DS6C	6	Two	Locking Snap Hook	Locking Snap Hook	377.00

# FALL ARREST & RESCUE

## ARC-RATED SHOCK-ABSORBING LANYARDS

- Designed to protect workers from electric arc-flash and arc-blast exposure
- Arc-rated Kevlar® webbing
- Available with Kevlar® choke-off loop for a "metal-less" connection
- Arc-Flash Standards: ASTM F887-05
- Connectors' Gate Load Capacity: 3600 lbs.
- Shock Absorber Type: Pack
- CSA Minimum Mass: 120 lbs.
- CSA Maximum Mass: 335 lbs.
- Certification(s): CSA Standard Z259.11

**Honeywell**  
**MILLER**

SGT531



Model No.	Mfg. No.	Length'	No. of Legs	Harness Connection	Anchorage Connection	Price /Each
<b>GREY</b>						
SGT506	M1FSFS-ES6C	6	One	Locking Snap Hook	Locking Snap Hook	264.00
SGT531	M1WLFC-ES6C	6	One	Choke-Off Loop	Scaffold Hook	273.00
SGT512	M1WLFS-ES4C	4	One	Choke-Off Loop	Locking Snap Hook	235.00
SGT537	M1WLFS-ES5C	5	One	Choke-Off Loop	Locking Snap Hook	197.00
SGT502	M1WLFS-ES6C	6	One	Choke-Off Loop	Locking Snap Hook	259.00
SGT544	M2FSFC-ES6C	6	Two	Locking Snap Hook	Scaffold Hook	587.00
<b>BLACK</b>						
SGT533	M1FSFC-KS6C	6	One	Locking Snap Hook	Scaffold Hook	194.00
SGT541	M1FSFS-KS4C	4	One	Locking Snap Hook	Locking Snap Hook	352.00
SGT493	M1FSFS-KS6C	6	One	Locking Snap Hook	Locking Snap Hook	400.00

## V-SERIES STANDARD LANYARDS

**MSA**  
The Safety Company

- The New V-Series shock absorbing lanyard line simplifies product selection by offering a concise line of standard lanyards that meet a wide range of customer needs
- Includes a clear, durable protective cover on the labels to increase service life, and allow for easy inspection
- Meets the new CSA Z259.11-17 standard for shock absorbing safety lanyards, with a current selection of standard (150-310 lbs.) and lightweight (100-230 lbs.) worker options

SGK246



Model No.	Mfg. No.	Number of Legs	Anchorage Connections	Length'	Price /Each
<b>CSA (150-310 LBS.)</b>					
SGK246	10188100	One	36C Small Snap Hook	6	76.60
SGK956	10188102	Two	36C Small Snap Hook	6	135.00
SGK957	10188103	One	36L Large Snap Hook	6	118.00
SGK958	10188101	Two	36L Large Snap Hook	6	168.00
<b>LIGHTWEIGHT CSA (100-230 LBS.)</b>					
SGK959	10190397	One	36C Small Snap Hook	6	76.60
SGK960	10190399	Two	36C Small Snap Hook	6	102.00
SGK961	10190398	One	36L Large Snap Hook	6	118.00
SGK962	10190400	Two	36L Large Snap Hook	6	168.00

## V-SERIES TIE-BACK LANYARDS

- A new easy identifiable symbol system to indicate the type of lanyard
- 5000 pound gate strength in any direction allows the FPSK carabiner to be tied directly to the lanyard
- Unique carabiner body shape that helps avoid confusion with standard connectors not designed for tie-back applications
- Meets the new CSA Z259.11-17 standard for shock absorbing safety lanyards, with a current selection of standard (150-310 lbs.)

**MSA**  
The Safety Company

SGK963



Model No.	Mfg. No.	Number of Legs	Anchorage Connection	Length'	Price /Each
SGK963	10193943	One	36C Small Snap Hook	6	168.00
SGK964	10193944	Two	36C Small Snap Hook	6	241.00

## REBEL™ SELF RETRACTING LIFELINES

- Lifeline Material: Galvanized Cable
- Harness Connection: Snap Hook
- Anchorage Connection: Carabiner
- Certification(s): CSA Standard Z259.2.2
- Rugged and extremely lightweight thermoplastic housing
- Stackable housing design
- Built-in carrying handle
- Galvanized steel cable lifeline is abrasion resistant and extremely durable
- Internal energy absorption system
- Swiveling self-locking snap hook with impact indicator
- Reserve lifeline system
- Swiveling anchorage point
- Side lifeline exit with ergonomic handle
- High strength, corrosion resistant components
- Self-locking anchorage carabiner keeps the SRL securely attached to the anchorage device
- **SES695**: Designed for the abusive leading edge applications, incorporating over-sized cable and an external energy absorption system that helps maintain lifeline integrity over abrasive edges



**3M** | **PROTECTA** | **SA**  
Fall Protection

Model No.	Mfg. No.	Length'	Thickness"	Price /Each
SE5695	3590541	20	7/32	886.00
SEE717	3590502	33	3/16	782.00
SEE718	3590552	50	3/16	1079.00

## NANO-LOK™ SELF-RETRACTING LIFELINES

- Extremely compact, lightweight design
- Tough and impact-resistant thermoplastic housing
- Swiveling anchorage loops
- Quick-activating speed-sensing brake systems
- Protected labels, equipped with i-Safe™
- Lifeline Length: 6'
- Certified to CSA standard Z259.2.2

SEE928

SEE930

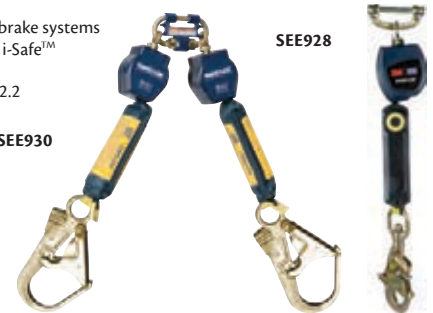

**3M** | **SALA**  
Fall Protection

Model No.	Mfg. No.	No. of SRLs	Harness Connection	Anchorage Connection	Price /Each
SEE929	3101230	1	Direct	Aluminum Carabiner	315.00
SEP794	3101232	1	Direct	Aluminum Rebar Hook	391.00
SEP904	3101245	1	Direct	Steel Snap Hook	238.00
SEE928	3101258	1	Direct	Steel Swivel Hook	227.00
SES651	3101222	1	Direct	Steel Rebar Hook	321.00
SES652	3101223	1	Direct	Steel Snap Hook	272.00
SEE930	3101286	2	Direct	Steel Rebar Hooks	592.00
SEE931	3101283	2	Direct	Aluminum Rebar Hooks	740.00
NJS982	3101311	2	Direct	Aluminum Snap Hooks	759.00

## NANO-LOK™ EDGE SELF-RETRACTING LIFELINES

- Suitable for applications when workers are anchored lower than the elevation of the dorsal d-ring on their full-body harness and/or the extracted lifeline can bear against an edge or surface during fall arrest
- Extremely compact, lightweight design
- Tough and impact-resistant thermoplastic housing
- Swiveling anchorage loops
- Quick-activating speed-sensing brake systems
- High-capacity external energy absorbers and impact indicators
- i-Safe™ equipped
- Certified to CSA standard Z259.2.2
- Lifeline Material: Stainless Steel
- Harness Connection: Direct



Model No.	Mfg. No.	No. of SRLs	Anchorage Connection	Price /Each
SEJ600	3500217	1	Snap Hook	461.00
SEJ601	3500218	1	Swivel Snap Hook	479.00
SEJ607	3500251	1	Rebar Hook	496.00
SEJ604	3500221	1	Aluminum Carabiner	479.00
SGD989	3500260	1	Comfort Grip Snap Hook	599.00
SEJ608	3500232	2	Snap Hooks	794.00
SEJ609	3500233	2	Swivel Snap Hooks	832.00
SEJ615	3500250	2	Rebar Hooks	864.00
SEJ614	3500238	2	Aluminum Rebar Locking Hooks	864.00
SGD988	3500259	2	Comfort Grip Snap Hook	895.00

## SMART LOCK SELF-RETRACTING LIFELINES

- Rugged and extremely lightweight thermoplastic housing with built in ergonomic handle
- 4ft. fall clearance allows workers up to 310 lbs. to meet OSHA's 1910 general industry rule
- Patented magnetic retraction control system allows lifeline retract smoothly, hands free
- Swiveling anchorage point and carabiner included
- Patented dual label system located within ergonomic cable handle to simplify inspections and reduce the need for replacement
- Swiveling snap hook with impact indicator
- Connected Safety RFID located in cable handle
- Certified to CSA Z259.2.2



Model No.	Mfg. No.	Description	Price /Each
SGJ254	3503800	Galvanized Cable, 30'	1348.00
SGJ255	3503801	Stainless Steel Cable, 30'	1507.00
SGJ256	3503803	Galvanized Cable, 20'	1111.00
SGJ257	3503804	Stainless Steel Cable, 20'	1493.00
SGJ258	3503821	Stainless Steel Cable, 35'	1738.00
SGJ259	3503823	Stainless Steel Cable, 50'	1792.00
SGJ260	3503824	Galvanized Cable, 50'	1632.00
SGJ261	3503802	Galvanized Cable, 20' - Leading Edge	1171.00
SGJ262	3503822	Galvanized Cable, 30' - Leading Edge	1634.00

## ULTRA-LOK™ SELF-RETRACTING LIFELINES

- Galvanized wire rope lifeline
- Maximum durability with minimal weight
- Stainless steel working components for corrosion resistance
- Durable polyurethane housing and aluminum side plates
- Anti-ratcheting, twin disc brake system limits arresting forces to 900 lbs. (4 kN) or less
- Smooth performance
- Swivel snap hook harness connection and steel hook anchorage connection
- Certified to CSA standard Z259.2.2



Model No.	Mfg. No.	Length'	Price /Each
SEB347	3504433C	20	1452.00
SEB345	3504430C	30	1815.00

## SEALED BLOK™ SELF-RETRACTING LIFELINES

- 30' Sealed Blok™ self-retracting lifeline that features a retrieval bracket and swivelling snap hook with impact indicator
- New sealed design keeps the critical working components (brake, power spring, energy absorber) free of dirt, grease, water and chemicals
- Built-in carrying handle makes transport and anchoring safe and easy, and provides a secondary "dropped objects protection" attachment point
- Large pivoting anchorage handle stays in line with load for added security and allows use of a variety of connecting hardware
- Anti-ratcheting brake stops falls within inches and limits arresting forces to 900 lbs. for added safety
- Cast aluminum housing and heavy gauge steel end plates resist damage and provide corrosion resistance
- Self-locking swivel hook with impact indicator makes connections easy, and provides a visual means of inspection
- Certified to CSA standard Z259.2.2



Model No. SEB589  
Mfg. No. 3400850C  
Price/Each \$4752.00



## MIGHTYLITE™ SELF-RETRACTING LIFELINES

Perfect solution for an array of construction, industrial, warehouse, utility, telecommunications, agriculture, mining and confined space applications.

- Ideal for hard-to-mount locations
- Corrosion-resistant stainless steel and aluminum components extend service life
- Carabiner and tagline included
- Locking snap hook harness connection and carabiner anchorage connection
- Length: 20'
- Rated to 310 lbs. (140.6 kg) capacity
- Certified to CSA standard Z259.2.2



Model No.	Mfg. No.	Lifeline	Price /Each
SD002	RL20G-27/20FT	3/16" Galvanised Cable	1402.00
SD003	RL20SS-27/20FT	3/16" Stainless Steel Cable	1612.00



# FALL ARREST & RESCUE

## TURBOLITE™+ SCORPION PERSONAL FALL LIMITER

- Enhanced graphics, icons, and colours on UV-resistant scratch-proof labeling
- New Miller look and feel, designs aligned with Honeywell harnesses for mix & match protection
- High-impact resistant nylon housing
- Abrasion-resistant webbing helps provide long service life
- Lifeline Length: 9'
- No. of SRLs: 1
- Lifeline Material: Web
- Unit Connector Material: Steel
- Lifeline Connector: Locking Snap Hook
- Lifeline Connector Material: Steel
- CSA Certification: SRL
- Max. Working Capacity: 420 lbs.
- Certification(s): Meets OSHA 1926.502, 1910.140, & ANSI Z359.14 Class 1 for Overhead & Class 2 for Leading Edge
- Housing: High Impact Nylon
- Hub: Shock-Absorbing Engineered Co-Polymer
- Braking Mechanism: Stainless Steel
- Thread: Polyester

SHH408



**Honeywell**  
MILLER

## FALCON™+ SELF-RETRACTING LIFELINE

- With cable lifeline and high-resistant nylon housing, the self-retracting lifeline withstands the harsh rigors of the toughest applications
- No. of SRLs: 1
- Lifeline Material: Galvanized Steel
- Swivel or Stationary: Swivel
- Unit Connector: Carabiner
- Unit Connector Material: Steel
- Lifeline Connector: Snap Hook
- Lifeline Connector Material: Steel
- Standard(s) Met: OSHA 1926.502, ANSI Z359.14-2021, CSA Z259.2.2-2017
- Min. Working Capacity: 130 lbs. (59 kg)
- Max. Working Capacity: ANSI/CSA 310 lbs. (141 kg), OSHA 420 lbs. (190.5 kg)
- Max. Arrest Distance: 42" (1.06 m)
- Avg. Arresting Force: 900 lbs. (4 kN)
- Max. Peak Arresting Force: 1800 lbs. (8kN)
- Unit Min. Ultimate Strength: 3000 lbs. (13.34 kN)

**Honeywell**  
MILLER

SGH043



Model No.	Mfg. No.	Swivel or Stationary	Unit Connector	Price /Each
SHH408	MTL-OHS1-01/9FT	Stationary	Stainless Steel Carabiner	355.00
SHG670	MTL-OHS1-55/9FT	Swivel	Stainless Steel Carabiner	369.00
SHG671	MTL-OHS1-71/9FT	Stationary	Stainless Steel Locking Rebar Hook	369.00

Model No.	Mfg. No.	Lifeline Length'	Price /Each
SHG043	MFS-OGC1-02/20FT	20	774.00
SHG044	MFS-OGC1-02/30FT	30	828.00
SHG045	MFS-OGC1-02/50FT	50	987.00

## TURBOLITE™+ PERSONAL FALL LIMITER

- Enhanced graphics, icons, and colours on UV-resistant scratch-proof labeling
- New Miller look and feel, designs aligned with Honeywell harnesses for mix and match protection
- High-impact resistant nylon housing
- Abrasion-resistant webbing helps provide long service life
- Lifeline Material: Web
- Unit Connector Material: Steel
- CSA Certification: SRL
- Max. Working Capacity: 310 lbs. (141 kg)
- Housing: High Impact Nylon
- Hub: Shock-Absorbing Engineered Co-Polymer
- Braking Mechanism: Stainless Steel
- Thread: Polyester
- Certification(s): Meets OSHA 1926.502, 1910.140, & ANSI Z359.14 Class 1 for Overhead & Class 2 for Leading Edge

SHH407



**Honeywell**  
MILLER

## FALCON™+ EDGE SELF-RETRACTING LIFELINE

- With cable lifeline and high-resistant nylon housing, the self-retracting lifeline withstands the harsh rigors of the toughest applications
- Designed to protect a worker in applications where the lifeline could come in contact with an edge in addition it can also be used in overhead applications as a traditional self-retracting lifeline
- Lifeline Length: 20'
- No. of SRLs: 1
- Lifeline Material: Galvanized Steel
- Swivel or Stationary: Swivel
- Unit Connector: Carabiner
- Unit Connector Material: Steel
- Lifeline Connector: Snap Hook
- Lifeline Connector Material: Steel
- CSA Certification: SRL-LE
- Standard(s) Met: OSHA 1926.502, ANSI Z359.14-2021, CSA Z259.2.2-2017
- Min. Working Capacity: 130 lbs. (59 kg)
- Max. Working Capacity: ANSI/CSA 310 lbs. (141 kg), OSHA 420 lbs. (190.5 kg)
- Max. Arrest Distance: 42" (1.06 m)
- Avg. Arresting Force: 900 lbs. (4 kN)
- Max. Peak Arresting Force: 1800 lbs. (8kN)
- Unit Min. Ultimate Strength: 3000 lbs. (13.34 kN)

**Honeywell**  
MILLER

SHG037



Model No.	Lifeline Length'	No. of SRLs	Unit Connector	Lifeline Connector	Price /Each
<b>STATIONARY</b>					
SHG531	11	1	Steel Carabiner	Steel Locking Snap Hook	364.00
SHH407	6	1	Steel Carabiner	Steel Locking Snap Hook	273.00
SHG675	6	1	Steel Carabiner	Steel Locking Rebar Hook	249.00
SHG676	11	1	-	Steel Locking Snap Hook	379.00
SHG677	6	1	-	Steel Locking Snap Hook	274.00
SHG679	6	1	-	Steel Locking Rebar Hook	259.00
SHG684	6	1	Aluminum Carabiner	Aluminum Locking Snap Hook	274.00
SHG619	6	1	Aluminum Carabiner	Aluminum Locking Rebar Hook	249.00
SHG688	6	1	Steel Locking Snap Hook	Steel Locking Snap Hook	284.00
SHG690	6	1	Steel Locking Snap Hook	Steel Locking Rebar Hook	259.00
SHG699	11	1	Steel Locking Rebar Hook	Steel Locking Snap Hook	379.00
SHG703	6	2	Steel Carabiner with G2 Connector	Steel Locking Rebar Hook	518.00
SHG707	6	2	Aluminum Carabiner with G2 Connector	Aluminum Locking Rebar Hook	518.00
<b>SWIVEL</b>					
SHG680	11	1	-	Steel Locking Snap Hook	379.00
SHG681	6	1	-	Steel Locking Snap Hook	274.00
SHG682	6	1	-	Steel Locking Rebar Hook	259.00

Model No.	Mfg. No.	Lifeline Length'	Shock Absorber Material	Price /Each
SHG037	MFS-LEP1-02/20FT	20	Ballistic Nylon CarbonX	1056.00
SHG038	MFS-LEP1-02/30FT	30	Ballistic Nylon CarbonX	1152.00
SHG039	MFS-LEP1-02/50FT	50	Ballistic Nylon CarbonX	1228.00
SHG040	MFS-LES1-02/20FT	20	Kevlar®	1152.00
SHG041	MFS-LES1-02/30FT	30	Kevlar®	1171.00
SHG042	MFS-LES1-02/50FT	50	Kevlar®	1286.00

## TURBOLITE™ EXTREME SHARP EDGE PERSONAL FALL LIMITERS

- Designed for use in sharp edge applications with radius  $\geq 0.005$  in (0.13 mm)
- Meets ANSI Z359.14 Class B and Leading Edge requirements
- Two buttons on harness connector positioned on two different planes require two distinct actions, preventing accidental disengagement
- Lightweight, compact harness connector with free-floating shock-absorber pack keeps workers cooler, and provides a more comfortable work experience
- Lifeline Material: Galvanized Steel
- Swivel or Stationary: Swivel
- Unit Connector: Without Unit Connector
- Unit Connector Material: Aluminum
- CSA Certification: SRL-LE



SGQ394



SGQ377

**Honeywell**  
MILLER

Model No.	Mfg. No.	Lifeline Length'	No. of SRLs	Lifeline Connector	Price /Each
SGQ377	MFLEC-11/9FTC	9	1	Aluminum Snap Hook	624.00
SGQ378	MFLEC-12/6FTC	6	1	Aluminum Rebar Hook	579.00
SGQ382	MFLEC-3/6FTC	6	1	Steel Snap Hook	534.00
SGQ383	MFLEC-3/9FTC	9	1	Steel Snap Hook	604.00
SGQ385	MFLEC-4/9FTC	9	1	Steel Rebar Hook	624.00
SGQ388	MFLEC2-12/6FTC	6	2	Aluminum Rebar Hook	1072.00
SGQ389	MFLEC2-12/9FTC	9	2	Aluminum Rebar Hook	1083.00
SGQ392	MFLEC2-3/6FTC	6	2	Steel Snap Hook	960.00
SGQ393	MFLEC2-3/9FTC	9	2	Steel Snap Hook	1017.00
SGQ394	MFLEC2-4/6FTC	6	2	Steel Rebar Hook	1006.00
SGQ395	MFLEC2-4/9FTC	9	2	Steel Rebar Hook	1086.00

## V-TEC™ PERSONAL FALL LIMITERS

- Compact and lightweight
- New design eliminates the need for an external energy-absorber outside of the housing
- High-impact polycarbonate transparent housing allows for easy visual inspection of internal components
- 360° fully rotating attachment point for complete flexibility
- Requires zero recalibration or adjustment
- Stainless steel components
- Certified to CSA standard Z259.2.2

SGC215



SFU591



**MSA**  
The Safety Company

Model No.	Mfg. No.	Lifeline	Harness Connection	Anchorage Connection	Price /Each
SGC215	63111-00ACA	6' Web	Twin-Link Connector	Rebar Hook	713.00
SGD369	63011-00ACA	6' Web	Carabiner	Scaffold Hook	368.00
SFU591	63013-00ECA	10' Web	Carabiner	Snap Hook	372.00

## V-TEC™ SELF-RETRACTING LIFELINES

- Premium components and innovative engineering
- Offers controlled cable retraction—preventing excessive lifeline retraction speed and protecting internal parts from damage
- Clear outer casing offers easy inspection
- Carry handle included for easy transportation
- Spring radial energy-absorbing technology requires zero calibration or adjustment
- Retraction dampening features controls the cable speed to  $<3\text{m/s}$
- Completely field serviceable, the cable, energy-absorber, and retraction dampener can all be replaced on site
- Certified to CSA Z259.2.2
- No. of SRLs: 1
- Unit Connector Material: Steel
- CSA Certification: SRL



SG1005

**MSA**  
The Safety Company

Model No.	Mfg. No.	Lifeline Length'	Lifeline Material	Unit Connector	Lifeline Connector	Lifeline Connector Material	Price /Each
SWIVEL							
SG1005	63306-00ACA	20	Stainless Steel	Carabiner	Rebar Hook	Aluminum	1169.00
SG1004	63206-00ACA	20	Stainless Steel	Carabiner	Snap Hook	Aluminum	1080.00
SHB537	63310-00ACA	30	Stainless Steel	Snap Hook	Snap Hook	Steel	1783.00
SHB539	63210-00ACA	30	Galvanized Steel	Snap Hook	Snap Hook	Steel	1644.00
SHB538	63315-00ACA	50	Stainless Steel	Snap Hook	Snap Hook	Steel	2120.00
STATIONARY							
SGZ588	63215-00ACA	50	Galvanized Steel	Snap Hook	Snap Hook	Steel	2014.00

## V-EDGE™ LEADING EDGE SELF-RETRACTING LIFELINES

- Specifically engineered and tested for use at foot-level tie off, the V-Edge™ SRL meets CSA Z259.2.2-2017 Leading-Edge requirements
- Use in a variety of applications, from overhead to horizontal tie off points, and where sharp edges are a concern
- Integrated roll cage protects housing when used in foot-level tie off
- Retraction dampening feature controls the life line speed—preventing unwanted damage and maximizing product life
- Clear outer casing allows for quick visual inspection of internal components
- Internal components like the cable and energy absorber can be replaced on site—reducing repair times
- No. of SRLs: 1
- Lifeline Material: Galvanized Steel
- Lifeline Connector: Snap Hook
- Lifeline Connector Material: Steel
- CSA Certification: SRL-LE



SGZ904

**MSA**  
The Safety Company

Model No.	Mfg. No.	Lifeline Length'	Unit Connector	Unit Connector Material	Price /Each
STATIONARY					
SGZ904	63406-00ACA	20	Single Pin	Aluminum	1396.00
SWIVEL, STATIONARY					
SHB540	63410-00ACA	30	Carabiner	Steel	2131.00
SHB541	63415-00ACA	50	Carabiner	Steel	2347.00

# FALL ARREST & RESCUE

## V-SHOCK® NON-LEADING EDGE PERSONAL FALL LIMITER

- V-Shock® Web PFLs feature easy-to-understand housing colour, dashboard labels, and iconography to help make PPE selection on the jobsite quick and easy
- Grey housing identifies the PFL as being for Overhead use vs. Leading Edge, and includes an icon signifying "Non Leading Edge"
- Easy-to-understand clearance charts have been added to the label pack, making it easier to access clearance data without the manual
- Lifeline Length: 6'
- Lifeline Material: Web
- Swivel or Stationary: Swivel
- Unit Connector: Carabiner
- Unit Connector Material: Steel
- Lifeline Connector: Snap Hook
- Lifeline Connector Material: Aluminum
- CSA Certification: SRL



Model No.	Mfg. No.	No. of SRLs	Snap Hook Type	Price /Each
SHC065	VSOHW-011-NC-C	1	ALTAKS-C	312.00
SHC067	VSOHW-011-NH-C	1	AL36CLS-C	335.00
SHC071	VSOHW-012-QC-C	2	ALTAKS-C	598.00
SHC073	VSOHW-012-QH-C	2	AL36CLS-C	642.00

## LAD-SAF™ CABLE VERTICAL SAFETY SYSTEM

- Designed to meet the requirements of the new ANSI Z359.16 standard, along with OSHA 1910.140 and 1926.502, when used with our Lad-Saf X3 Detachable Cable Sleeve (6160054) and Lad-Saf X2 Detachable Cable Sleeve (6160030)
- Reengineered to simplify and speed up the installation process
- Integrated fall arrest-rated anchor point on top bracket rated to 3600 lbs provides 100% tie-off capability
- Galvanized steel bracket fits up to 1-1/8" (2.85 cm) rung diameter and attaches to two rungs
- Integrated tension-indicating bottom bracket takes the guesswork out of installation
- Compatible with Lad-Saf™ X3 Detachable Cable Sleeve for better climbing performance and fall protection (sold separately)
- Non-metallic Cable Guide hardware for easy-to-use hand operation, with mounting hardware for systems up to 199' (60.6 m), fits up to 1-1/8" (2.85 cm) rung diameter (recommended one every 25' / 7.6 m)
- Material: Galvanized Steel
- Installation Type: Permanent
- Maximum No. of Users: 2
- Single Point Anchor Rating: 3600 lbs.
- Weight Capacity (2 Users): 620 lbs. (281 kg)
- Weight Capacity (1 User): 310 lbs. (140 kg)
- Specification(s) Met: ANSI Z359.16, OSHA 1910.29, OSHA 1926.1053, RR-W-410
- Diameter: 3/8"



Model No.	Mfg. No.	Length'	Price /Each
SGY439	6118020	20	876.75
SGY440	6118030	30	921.90
SGP408	6160054	Lad-Saf™ X3 Detachable Cable Sleeve	795.90

## ROLLGLISS™ R550 RESCUE & DESCENT DEVICE

- Emergency rescue and evacuation from a wide variety of elevated work areas
- Fully automatic controlled descent
- Bidirectional design enables multiple rescues
- Built-in rescue lifting wheel
- 100 ft. (30.5 m) 3/8" (9.5 mm) kernmantle rope lifeline
- Rated for up to 1 640 ft. (500 m) height for one user, 575 ft. (175 m) for two users
- Compact and lightweight design
- High strength corrosion resistant construction
- Integrated rope ears
- Dual brake design
- Equipped with i-Safe™
- Kit also contains 4 ft. (1.2 m) anchor sling, two carabiners and carrying bag
- No. of users: 2
- Lifeline material: Kernmantle
- Harness connection: Carabiner
- Anchorage connection type: Snap hook
- CSA Standard Z259.2.2



Model No. **SDL610**  
Mfg. No. 3327100  
Price/Each \$1921.98

### PULLEY - ROLLGLISS™ R550

- Single
  - 9-16 mm
- Model No. **SDL611**  
Mfg. No. 9504733  
Price/Each \$172.20



## ROOF ANCHORS

- Fast and easy installation
- Installs to sloped or flat wood and metal decking roofs
- Non-penetrating design
- Swiveling self-retracting lifeline bracket
- Compact and lightweight design
- Secondary D-ring anchor point
- Adjustable legs, 360-degree swiveling
- Pair the DBI-SALA® roof anchors with the 3M™ DBI-SALA® Smart Lock SRLs



Model No.	Mfg. No.	Description	Price /Each
SGJ694	2190073	3M™ DBI-SALA® Standing Seam Roof Anchor	1235.96
SGJ695	2190071	3M™ DBI-SALA® Swiveling Roof Anchor	748.36
SGJ696	2190074	3M™ DBI-SALA® Construction Roof Anchor	2952.00
SGJ697	2190072	3M™ Protecta® Standing Seam Roof Anchor	718.68
SGJ698	2190070	3M™ Protecta® Swiveling Roof Anchor	517.28



## COMFORT GRIP CONNECTOR

- Transverse load rated self-locking/closing aluminum Comfort Grip connector
- Built-in connector for single-leg SRL direct attachment to harness
- Extremely compact, lightweight design
- Tough and impact-resistant thermoplastic housing
- Swiveling anchorage loop
- Quick-activating speed-sensing brake system
- High-capacity external energy absorber and impact indicator
- i-Safe™ equipped
- Certification: CSA standard Z259.12 for transverse loading
- Note that this connector pairs with many of 3M lanyards and SRLs so multiple configurations are available

**Model No. SGJ693**  
**Mfg. No. 1246415**  
**Price/Each \$720.30**



## CONCRETE DETENT ANCHORS

- Reusable detent pin assembly allows a user to tie-off anywhere a socket is pre-installed with a push of a button
- Lightweight and portable
- Socket can be installed vertically or overhead into a concrete wall, floor, or ceiling
- Rugged, corrosion resistant stainless steel

**Model No. SEJ623**  
**Mfg. No. 2101004**  
**Price/Each \$528.94**



## CABLE TIE-OFF ADAPTORS

- 1/4" coated galvanized cable
- Lightweight and extremely durable
- Stands up to harsh environments
- Snap hook at one end, O-ring at the other
- Length: 6'

**Model No. SEB470**  
**Mfg. No. AJ408CG-6**  
**Price/Each \$135.68**



## CARABINERS

- Steel carabiners
- Self locking/closing
- 3600-lb. gate

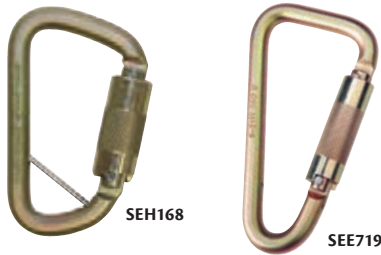

Model No.	Mfg. No.	Gate Opening"	Price /Each
SEH168	2000117	25/32	24.15
SEE719	2000113	1-3/16	46.20

## ANCHORAGE CONNECTING CARABINER

- High strength steel construction
- Corrosion resistant zinc plated hardware
- 11/16" gate opening
- 420 lbs. capacity
- 3600 lbs. gate strength
- Self-closing and locking gate for added safety

**Model No. SEB926**  
**Mfg. No. 2000112**  
**Price/Each \$23.10**



## CONCRETE D-RING ANCHORS

- Reusable D-ring assembly
- Rugged design for harsh environments
- Safe "hook-up" indicator notifies user of proper installation
- Install into 11/16" or 3/4" holes - only standard drill bits needed

**Model No. SEB438**  
**Mfg. No. 2104568**  
**Price/Each \$187.62**



## D-RING ANCHORAGE PLATES

- Can be bolted or welded to a structure, offering a compact, reliable connection point
- Two 1/2" diameter attachment holes
- Cadmium plated steel D-ring
- 304 stainless steel anchorage plate
- Plate size: 1/4" x 2" x 4 1/2"

**Model No. SEB449**  
**Mfg. No. 2101639**  
**Price/Each \$95.40**



# FALL ARREST & RESCUE

## FIXED BEAM ANCHORS

- Installs in seconds to the beam structure in any orientation
- Final tightening using a built-in adjustment handle
- Fits up to 1 1/2" thick beam flange, 2 1/2" to 12" wide

**Model No. SEE808**  
**Mfg. No. 2108406**  
**Price/Each \$991.10**



## FREESTANDING COUNTERWEIGHT ANCHORS

- Freestanding system is easily placed on top of the roof surface to provide tie-off point for one worker

**Model No. SEE809**  
**Mfg. No. 2100185**  
**Price/Each \$5394.34**



## ROLLGLISS™ RESCUE POLE

- Allows assisted rescue of worker after a fall
- Extension pole adjusts from 4 ft to 16 ft (1.2 m to 4.9 m)
- Does not require special tools or training
- Enables faster and more efficient rescues
- Oversized connection hook
- Compact and lightweight design
- Colour: Red & Silver

**Model No. SHA876**  
**Mfg. No. 8900298**  
**Price/Each \$689.07**



## COBRA™ MOBILE/MANUAL ROPE GRAB WITH LANYARD

- Mobile design automatically follows user
- Manual option allows user to fix in place
- Cam locking system for safety
- Integral 2 ft. (0.6 m) PRO™ shock absorbing lanyard
- Detachable anywhere along the lifeline
- Durable and lightweight corrosion-resistant construction
- For use with 5/8" (16 mm) diameter polyester/polypropylene blend rope lifeline
- Rope Diameter: 5/8"

**Model No. SEP896**  
**MFG No. AC202C-SA2**  
**Price/Each \$286.65**



## SLIDING BEAM ANCHOR

- Versatile size ranges to fit a variety of beams
- Replaceable wear pads
- 360-degree swiveling D-ring anchor point
- Integrated dual ratcheting system
- High-strength, lightweight steel and aluminum construction
- 5000 lb. strength and up to 420 lb. (189 kg) capacity
- Type: Temporary
- Style: I-Beam

**Model No. SGJ699**  
**Mfg. No. 2104710**  
**Price/Each \$465.34**



## DOOR/WINDOW JAMB ANCHORS

- Fits door or window sizes ranging from 21 1/2" to 51 1/2" in width
- Non-penetrating design ensures no damage to structure
- Fast and easy installation with built-in adjustment knob – no tools or drilling are required
- Lightweight and extremely portable design

**Model No. SEJ618**  
**Mfg. No. 2100080**  
**Price/Each \$1038.80**



## BEAM TROLLEY ANCHORAGE CONNECTORS

- Installs easily and quickly overhead with no tools necessary at ends or midpoint on beams
- Non-corrosive double-shielded wheel bearings provide smooth and effortless operation
- Trolley guards protect the wheels from damage and keep the beam ahead of the trolley clear of debris
- Provides added maneuverability, improved safety, and increased productivity
- Fits flat or tapered beam flanges 3" to 8" wide, and up to 11/16" thick

**Model No. SEJ617**  
**Mfg. No. 2103143**  
**Price/Each \$1199.92**



## ROPE LIFELINES

- 16 mm (5/8") diameter, polyester sheath with polypropylene core
- Tensile strength: 2540 kg (5600 lbs.)
- Zinc plated stamped steel hook
- Net weight: 5.6 lbs. (25 kg)

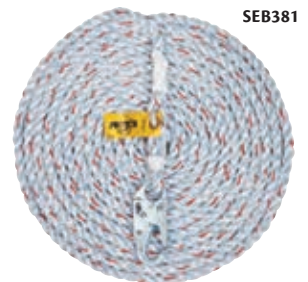

Model No.	Mfg. No.	Length'	Price /Each
SEB381	SSR100-50	50	194.25
SEB382	SSR100-100	100	303.45

## CROSS-ARM STRAPS

- Web cross-arm strap wraps around I-beams and other structures
- Attaches with a 2" D-ring that slips through a 3" D-ring
- Forms a secure attachment point for lanyards and other connecting devices
- 400-lb. maximum capacity

**Honeywell**  
**MILLER**

Model No.	Mfg. No.	Length'	Price /Each
SEP327	8183/2FTGN	2	86.90
SEP329	8183/4FTGN	4	86.90
SD009	8183/6FTGN	6	108.00
SEP316	8183/10FTGN	10	166.00



## ANCHORAGE CONNECTOR WITH HARDWARE

- Designed as the intermediary for securing a connecting device to an anchorage
- Meets OSHA 1910.66, OSHA 1926.502(d), ANSI A10.32, and ANSI Z359.1 requirements
- Accommodates working thicknesses up to 4" (101.6mm)
- Includes: 5/8" Grade 8 bolt, Lockwasher, Nut
- Type: Permanent
- Style: D-Ring
- Max. Working Load: 400 lbs. (181kg)
- Tensile Strength: 5000 lbs. (22kN)
- Material: Drop Forge Alloy Steel
- Weight: 1 lb. 8 oz. (0.7kg)

**Honeywell**  
**MILLER**



Model No.	Mfg. No.	Price /Each
SEP264	416/	127.00

## ANCHORAGE CONNECTOR

- Reusable chain with 'O' Ring for steep-pitched or flat roof
- Type: Temporary
- Style: Roof



Model No.	Mfg. No.	Price /Each
SHB921	RA30-1/	2206.00

## ROOF ANCHORS

- Ideal for new construction or as a retrofit on roofs with asphalt, shake or tile roofing materials
- Multiple use applications: new roof/shingle installation, gutter cleaning, window and skylight cleaning/repair, chimney maintenance and general roof maintenance
- Stainless steel body construction and zinc-plated steel D-rings resist corrosion for long service life
- Designed to provide two (2) D-ring anchorage points when securely installed on a wood roof sub-surface
- Accommodates single user of up to 310 lbs. (140.6kg) for fall protection
- Meets OSHA 1926.502 guideline
- Type: Permanent
- Style: D-Ring
- Material: Stainless Steel

**Honeywell**  
**MILLER**



Model No.	Mfg. No.	Description	Price /Each
SEP482	RA40/	Double Roof Anchor	75.00
SEP483	RA41/	Single Roof Anchor	69.00

## D-BOLT PERMANENT ANCHORAGE CONNECTORS

- 1/2" diameter D-bolt anchor
- One-piece unit with lockwasher and nut
- 400-lb. maximum capacity

**Honeywell**  
**MILLER**

Model No.	Mfg. No.	Price /Each
SD005	415	113.00



## ANCHORAGE CONNECTOR

- D-bolt anchor without hardware
- Can be installed on a vertical wall or overhead for versatility
- Type: Permanent
- Style: D-Ring

**Honeywell**  
**MILLER**

Model No.	Mfg. No.	Price /Each
SHB920	417/	115.00



## BEAM TROLLEYS

- Steel anchor point that can be attached to horizontal I-beams
- Adjustable beam trolley slides along with the worker to provide maximum mobility
- 400-lb. maximum capacity

**Honeywell**  
**MILLER**

Model No.	Mfg. No.	Description	Beam Width"	Price /Each
SD010	9065/BK	Beam Trolley	3 to 4 1/2	1002.00
SAK435	9065-1	Adapter Kit for SD010	3 to 8 1/2	221.00



## SWIVEL ANCHOR

- Provides freedom of movement with innovative swivel design that offers 360° D-ring rotation and 180° flip
- For use in concrete
- 10 000 lbs. (10K) tensile strength
- Rated for up to a 310 lbs (141 kg) user
- Type: Permanent
- Style: D-Ring

**Honeywell**  
**MILLER**

Model No.	Mfg. No.	Price /Each
SHB923	RACSWY100C	209.00



## CLAW ANCHORAGE ROOF CONNECTOR

- Designed to provide a single anchorage point when securely installed on a wood rafter or truss member
- Fits wood sizes 2" x 4", 2" x 6", 2" x 8", 2" x 10" or 2" x 12"
- Stainless steel construction
- Accommodates single user for fall protection
- Type: Permanent



Model No.	Mfg. No.	Price /Each
SHB922	RA45/	107.00

**Honeywell**  
**MILLER**



# FALL ARREST & RESCUE

## CARABINERS

- Twist-lock gates
- 400-lb. (181.4 kg) maximum capacity.



**Honeywell**  
MILLER

Model No.	Mfg. No.	Material	Gate Opening"	Price/Each
SAK327	17D-1	Steel	1	61.70
SAK328	17D-2-Z7/	Aluminum	1	132.00
SAK330	18D-1	Steel	2	149.00
SAK331	18D-2-Z7/	Aluminum	2 1/4	172.00

## POINTGUARD™ ANCHORAGE STRAPS

- Durable polyester webbing is economical, quick and easy to install
- When anchorage connector is no longer needed, simply cut strap and throw away
- Available in two models:
  - Residential construction (3' length)
  - Concrete construction (4' length, includes protective sheath)
- 400-lb. (182 kg) capacity



**MSA**  
The Safety Company

Model No.	Mfg. No.	Type	Anchorage Connector	Length'	Price /Each
SAM476	10042792	Residential	D-Ring	3	14.10
SAM477	10042793	Residential	Web Loop	3	10.90
SAM478	10042794	Concrete	D-Ring	4	13.30
SAM479	10042795	Concrete	Web Loop	4	16.80

## FP STRYDER BEAM ANCHORS

- Easy, single hand installation
- Lightweight 4.5 lbs. unit
- Low friction wear pads with Teflon™ allows the anchor to glide effortlessly along the beam flange
- Integral load indicator alerts the user if the unit has been exposed to a fall
- Versatile design allows for mounting overhead or at worker's feet
- Easy to use, push-button adjustment with 1/4" adjustment intervals
- 400 lbs. work capacity



**MSA**  
The Safety Company

Model No.	Mfg. No.	Fits Beams"	Price /Each
SGC228	10144431	4 to 13.5	363.00
SA0684	10144432	14 to 23.5	540.00

## PERMANENT ROOF ANCHOR

- All steel construction
- Fits all pitches of roof trusses or rafters
- Easy to install without special tools
- Type: Permanent
- Style: Roof



**MSA**  
The Safety Company

Model No.	Mfg. No.	Size"	Price /Each
SAM494	10016468	2 x 4	94.70
SAM495	10017593	2 x 6	102.00

## ANCHORAGE STRAPS

- D-ring on one end and a sewn loop on the other end
- Length: 5'



**MSA**  
The Safety Company

Model No.	Mfg. No.	Material	Price/Each
SAM474	505282	Nylon	65.00
SAM475	505298	Polyester	75.50

## D-PLATE ANCHORAGE CONNECTORS

- Provides permanent anchorage point
- Bolts to beams or columns



**MSA**  
The Safety Company

Model No.	Mfg. No.	Material	Price /Each
SAM483	506632	Zinc-Plated Steel	40.20

## ROPE GRAB FALL ARRESTER

- Hands-free operation while ascending or descending
- Ultra-smooth travel action
- Cam and hinge design allows for a quick, easy installation on the rope
- Rope Diameter: 5/8"

**MSA**  
The Safety Company



Model No. SGC222  
Mfg. No. 10077718  
Price/Each \$274.00

## CARABINERS

- Auto-locking
- Minimum breaking strength of 5000 lbs.
- Material: Steel

**MSA**  
The Safety Company



SGD364



SAM500



SGD362

Model No.	Mfg. No.	Gate Opening"	Price /Each
SGD364	10089205	9/16	54.80
SAM500	10089207	1	56.20
SGD362	10089209	2.1	105.00

## D-RING TOOL ATTACHMENT POINTS

### WEB D-RING

- D-Rings can be attached to virtually any tool under their Load Rating lbs. using Quick Wrap Tape
- Creates an instant attachment point in less than a minute
- Compact size is perfect for many hand tools

### CORDED D-RING

- Loop the D-Ring cord through a pre-drilled hole or closed handle to create an instant attachment point
- Long lasting construction will stand up to the elements
- Reusable device can easily be moved from one tool to another as required



Model No.	Mfg. No.	Style	Load Rating lbs.	Dimensions W" x L"	Price /Each
SDP315	1500003	Web D-Ring	2.0	0.5 x 2.25	7.83
SDP316	1500007	Web D-Ring	5.0	1 x 3.5	8.45
SDP317	1500009	Corded D-Ring	5.0	- x -	7.83

## QUICK SPIN TOOL ATTACHMENT POINTS

- Simply slides on to the handle of a tool, making it tether-ready in seconds
- Swivel spin top makes tethering tangle-resistant
- Reusable and suitable for non-conductive use
- Load Rating lbs.: 1.0 lbs.



Model No.	Mfg. No.	Diameter"	Price/Each
SDP322	1500029	1	174.10
SDP323	1500030	1.2	174.10

## ADJUSTABLE TOOL TETHERING WRISTBANDS

- Constructed with a hook and loop system to adjust to any wrist size



Model No.	Mfg. No.	Load Rating lbs.	Connection Point	Price/Each
SDP340	1500082	5.0	Sewn-on D-Ring	33.99
SDP341	1500084	5.0	Built-in cord	28.84
SDP342	1500086	1.5	Built-in retractor	55.50

## BUNGEE TOOL TETHERS

- Features a locking carabiner with screw locks that prevent accidental opens
- Versatile bungee design reduces trip and entanglement hazards while remaining suitable for use with a variety of hand tools
- 5/8" tubular webbing, built from abrasion-resistant materials to last longer in harsh work environments

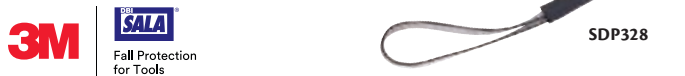

Model No.	Mfg. No.	Load Rating lbs.	Length"	Relaxed Length"	Price/Each
SDP327	1500047	10.0	47	32	36.50
SDP328	1500049	35.0	52	31	65.92

## SPRAY CAN/BOTTLE HOLSTER

- Neoprene holster with a side-release composite buckle
- Adjustable strap allows the holster to conform to the size of your water bottle or spray can
- Includes a 7-70 mm aluminum carabiner

Model No. SDP344  
Mfg. No. 1500091  
Price/Each \$24.72



## TOOL CINCH ATTACHMENT POINTS

- Cinch design allows users to quickly secure a wide variety of tools, minimizing delays and improving productivity
- Suitable for many medium and large tools
- Stabilization wings allow the cinch to be secured to the tool using Quick Wrap Tape for added security and stability



Model No.	Mfg. No.	Stabilization Wings	Load Rating lbs.	Price/Each
SDP318	1500011	None	35.0	22.66
SDP319	1500013	1	35.0	33.99
SDP320	1500015	2	35.0	45.32
SDP321	1500017	2	80.0	48.93

## QUICK WRAP TAPE II

- Creates instant tethering points
- Redesigned Quick-Wrap Tape II helps deliver long-lasting tool attachment performance
- Resists tears better
- Stretches further
- Quick and easy installation
- Stays out of the way
- Reduces tool downtime

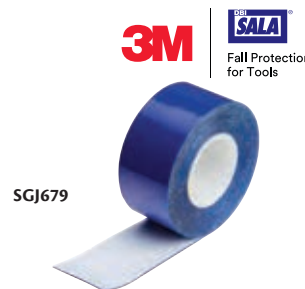

Model No.	Mfg. No.	Description	Price/Each
SGJ679	1500168	1" Blue	38.63
SGJ680	1500174	1" Yellow	34.51

## TOOL LANYARDS

- Economical tethering solution for most hand tools
- User-friendly thumb triggers are provided on both ends of the lanyard
- Trigger latches swivel for tangle resistance
- Connector Type: Dual Latch
- Load Rating lbs.: 10.0 lbs.



Model No.	Mfg. No.	Length"	Price/Each
SDP331	1500053	12	19.06
SDP332	1500055	24	19.57

## COIL TOOL TETHERS

- Built from non-conductive, lightweight vinyl that is easy to clean and withstands harsh work environments
- Ultra-compact coil design naturally stays out of the way



Model No.	Mfg. No.	Connector Type	Load Rating	Length"	Relaxed Length"	Price /Each
SDP333	1500059	Dual Clip	2.0 lbs.	24	1.75	22.15
SDP334	1500060	Clip/Loop	2.0 lbs.	34	7	22.15
SGI620	1500178	Dual Clip For Hard Hat	4.0 lbs.	36	5.5	15.35
SDP337	1500067	Dual Latch	5.0 lbs.	24	1.75	22.66

## TOOL TETHERING BELT LOOP ATTACHMENT POINT

- Used for tying off tools from belt
- Load Rating lbs.: 5.0 lbs.



Model No.	Mfg. No.	Style	Price/Each
SDP353	1500115	Web D-Ring	13.91

# FALL ARREST & RESCUE

## COMFORT TOOL BELT

- Unique design that provides both strength and comfort
- Extra padding provides superior comfort compared to many other tool belts
- Modular approach allows user to customize their own holster and pouch system
- Size: Large/X-Large
- Waist Size: 36" - 44"

**Model No. SDP351**  
**Mfg. No. 1500111**  
**Price/Each \$198.79**



## TOOL POUCH HOLSTER

- Belt holster with rear-feed retractor
- Quickly holster tape measures and other small tools
- Tether Included: Single Retractor Lanyard
- Tether Connector Type: Key Ring
- Tether Length: 52"
- Tether Load Rating lbs.: 1.5 lbs.

**Model No. SDP345**  
**Mfg. No. 1500095**  
**Price/Each \$127.00**



## TAPE MEASURE HOLSTER

- Heavy-duty neoprene conforms to many tape measure sizes
- A clip on the back of the sleeve can be used to clip to a belt or holster
- Designed for use with Tape Measure Holster
- Tether Included: Single Retractor Lanyard
- Tether Connector Type: Key Ring
- Tether Length: 52"
- Tether Load Rating lbs.: 1.5 lbs.

**Model No. SDP347**  
**Mfg. No. 1500100**  
**Price/Each \$107.00**



## SMALL PARTS POUCH

- Innovative self-closure system makes it nearly impossible for objects to fall out, even when the pouch is flipped vertically
- Easy to retrieve objects since no opening or closing is necessary
- Compatible with most tool belts or harnesses
- Colour: Black
- Material: Canvas

**Model No. SDP355**  
**Mfg. No. 1500119**  
**Price/Each \$131.84**



## ADJUSTABLE RADIO/CELL PHONE HOLSTER

- Adjusts to the fit virtually any hand-held radio, cell phone and many other portable devices
- Includes a micro D-ring that can be placed on the device and then tethered to the radio holster
- Can be worn from a belt or harness
- Tether Included: Single Coil Lanyard
- Tether Connector Type: Clip/Loop
- Tether Length: 34"
- Tether Length Relaxed: 7"
- Tether Load Rating lbs.: 2 lbs.

**Model No. SDP343**  
**Mfg. No. 1500089**  
**Price/Each \$55.62**



## SCAFFOLD WRENCH HOLSTER

- Hook and loop closure strap keeps tools secure
- High visibility reflectors
- Rear-feed retractor tether included
- Includes an additional D-ring connection point that can be used in conjunction with appropriate tether (sold separately) when higher Load Rating lbs. is required
- D-Ring Load Rating lbs.: 5 lbs.
- Tether Included: Single Retractor Lanyard
- Tether Connector Type: Key Ring
- Tether Length: 52"
- Tether Load Rating lbs.: 1.5 lbs.

**Model No. SDP346**  
**Mfg. No. 1500096**  
**Price/Each \$85.50**



## TOOL LIFTING SAFE BUCKET

- Designed to be used at height, with a built-in closure system that helps to prevent dropped objects
- Includes multiple D-Ring connection points that can be used to tether tools
- Hard composite plating sewn into the bottom and covered with a protective leather sleeve protects the bucket from accidental punctures and is resilient to the elements and harsh work environments
- Equipped with a heavy-duty hoisting/shoulder strap that features a high-quality, lightweight aluminum twist-lock carabiner for lifting and hoisting
- Closure System: Hook & Loop
- Material: Canvas
- Capacity: 1840 in<sup>3</sup>
- Diameter: 12.5"
- Height: 15"
- Load Rating lbs.: 100 lbs.
- D-Ring Load Rating lbs.: 10 lbs.

**Model No. SFV223**  
**Mfg. No. 1500134**  
**Price/Each \$221.45**



## TOOL HOLSTERS

- Equipped with two D-Rings for tool tethering
- Features Quick-Mag™, a powerful magnetic tool staging system that allows tools to stick to the holder and holds them in place without holstering so they are always at the ready
- Beacon™ High Visibility Reflectors stitched into the front and back of the holster
- Bottom drain vent allows water to pass through in rainy conditions, protecting your tools from rusting and your holster from dry rot
- D-Ring Load Rating lbs.: 5 lbs.



SDP348

Model No.	Mfg. No.	Type	Tether Included	Tether Connector Type	Tether Length	Tether Load Rating lbs.	Price /Each
SDP348	1500104	Single Tool Holster	Single Retractor Lanyard	Key Ring	52"	1.5	110.00
SDP349	1500105	Extra Deep Single Tool Holster	None	-	-	-	64.00



## SQUIDS® TOOL LANYARDS

- Nylon or polyester tubular elastic material stretched to allow flexibility in use and to help absorb the impact of a dropped tool
- Lightweight aluminum carabiner quickly attaches to a wide range of locations
- Model **TEP213** and **SEE102** have reflective stitching that runs the length of the product for added visibility



SEE102



SGH788



SGH779



Model No.	Mfg. No.	Colour	Length"	Anchorage Connection	Tool Connection	Load Rating lbs.	Price /Each
TEP213	19002	Black	35-45	Carabiner	Adjustable Barrel Lock	10	18.90
SEE102	19003	Lime	35-45	Carabiner	Adjustable Barrel Lock	10	18.90
SGH782	19822	Orange/Grey	38-48	Carabiner	Carabiner	10	25.50
SGH778	19808	Orange/Grey	38-48	Loop	Carabiner	15	32.80
SGH788	19828	Orange/Grey	38-48	Carabiner	Carabiner	15	51.10
SGH779	19809	Orange/Grey	38-48	Loop	Carabiner	25	54.80
SGH789	19829	Orange/Grey	38-48	Carabiner	Carabiner	25	91.40

## ARSENAL® HOIST BUCKET

- Molded plastic top ring to maintain wide opening for viewing and accessing contents
- High tensile strength web handle with leather reinforcement
- Heavy-gauge nylon stitching
- Interior pocket
- Patented nickel-plated storm drain
- Third-party certified to a 5:1 safety factor

SGS626



SGS624



SGS622



Model No.	Mfg. No.	Dimensions Dia." x H"	Description	Colour	Load Rating lbs.	Price /Each
<b>CANVAS HOIST BUCKET</b>						
SGS622	14940	12.5 x 17	Web Handle & Swiveling Carabiner	Grey	150	209.00
SGS623	14930	12.5 x 17	Web Handle	Grey	150	163.00
<b>NYLON HOIST BUCKET</b>						
SGS624	14970	12.5 x 15	Web Handle & Swiveling Carabiner	Black	100	132.00
<b>HOIST BUCKET TOP</b>						
SGS626	14938	12.5 Dia.	Optional Safety Top	Black	-	43.30

## SQUIDS® 3770 TAPE MEASURE TRAP

- 1200D and 600D polyester main material
- Hook and loop straps secure tape measure inside trap for safe and easy tethering
- Zinc-plated cast alloy D-Ring
- Maximum safe working capacity: 2 lbs.
- Third party tested using a 2:1 safety factor
- Capacity: 2 lbs.
- Tape measure sold separately



SDN854



Model No.	Mfg. No.	Colour	Size	Fits Measuring Tape	Price /Each
SDN854	19770	Orange	Large	16' - 25'	31.70
UAJ687	19771	Black	X-Large	30' - 40'	35.60

## SQUIDS® 3775 CAN/BOTTLE HOLDER & TRAP

- Neoprene primary material is abrasion-resistant and stretches to fit a variety of bottles/cans
- Heavy-gauge nylon stitching for extra reinforcement
- Convenient stainless steel belt clip attaches to tool belts and fall protection harnesses
- Zinc-plated, D-ring for tool lanyard attachment
- Adjustable buckle closure to securely hold the bottle/can in the holder
- Fits standard 16.9 oz. (0.5 L) water bottles, spray paint cans, WD40 canisters and more
- Third party certified to a 2 lbs. (0.9 kg) maximum capacity
- Tether Included: None

Model No. **SGH804**  
Mfg. No. 19775  
Price/Each **\$28.90**



## SQUIDS® HARD HAT LANYARDS

- Comfortably attaches to hard hats and other headwear to prevent the item from falling
- Buckle connecting lanyards feature a double lock plastic buckle that attaches to your fall protection
- Maximum safe working capacity: 2 lbs. (0.9 kg)
- Third party tested using a 2:1 safety factor
- Hard hat not included

### SQUIDS® 3150 & 3155 STANDARD LANYARDS

- High-stretch elastic material allows workers to move their head freely

### SQUIDS® 3157 & 3158 COIL LANYARDS

- Coil design reduces lanyard length and prevents snag and tangle hazards while maintaining the workers range of motion



SED573



SDL091

Model No.	Mfg. No.	Colour	Connection Type	Price /Each
<b>STANDARD LANYARDS</b>				
SED573	19150	Lime	Buckle	8.69
SED574	19155	Lime	Clamp	8.69
<b>COIL LANYARDS</b>				
SDL089	19156	Black	Clip	9.81
SDL090	19157	Lime	Buckle	9.81
SDL091	19158	Black	Clamp	9.81
SDL092	19159	Lime	Clamp	9.81

# FALL ARREST & RESCUE

## SQUIDS® PULL-ON WRIST LANYARD

- Pull-on wrist lanyard connection tethers tools limiting the distance of a dropped tool and reducing snag hazards
- Elastic maintains snug fit
- Pull-on design is easy to take on and off
- One-size-fits-all
- Third party tested using a 2:1 safety factor
- Approved to the ANSI/ISEA 121-2018 standard
- Patented design
- Load Rating: 3 lbs.
- Size: Adjustable



SGH786

SGH785



Model No.	Mfg. No.	Description	Price /Each
SGH785	19056	With Carabiner	18.40
SGH786	19057	With Buckle	15.40

## SQUIDS® COILED CABLE LANYARD

- Constructed with PU-covered aircraft cable
- Stainless steel carabiners
- Coil design prevents snag and tangle hazards
- Swiveling design prevents tangles and fast recoil
- Captive eye carabiner
- Style: Coil
- Connector Type: Dual Carabiner
- Length: 50"



SEM791



Model No.	Mfg. No.	Load Rating lbs.	Price /Each
SEM791	19130	2	40.10
SEM792	19131	5	44.00

## SQUIDS® TOOL LANYARD

- Patented lightweight aluminum carabiner with double action self-locking gate connects to tools like wrenches, grinders, drills, impact drivers, and more
- Tether keeps tools weighing 0.5 lbs. in a retracted state and prevents tools weighing 5 lbs. (SGS628) or 8 lbs. (SGS627) from falling on people or objects below
- ABS plastic housing protects the internal components with a cut-resistant Dyneema™ cord with a durable protected weave to hold up in tough environments
- Retractable design limits snags, tangles and tripping hazards
- Trigger switch locks cord into fixed lengths to take the tension out
- A red cord is revealed when exposed to forces exceeding 110 lbs., letting the user know if a drop has occurred
- Length: 48"
- Retracted Length: 10"
- Lanyard Weight: 0.5 lbs
- Third-party certified to meet the ANSI/ISEA 121-2018 Standard



SGS627



Model No.	Mfg. No.	Connector Type	Load Rating lbs.	Price /Each
SGS628	19310	Carabiner/Clip	5	67.70
SGS627	19311	Dual Carabiner	8	83.50

## SQUIDS 5540 BARCODE SCANNER HOLSTER FOR GUN GRIP MOBILE COMPUTERS WITH BELT LOOP

- Prevents costly drops and keeps barcode scanners close and ready
- Abrasion-resistant industrial grade ripstop polyester for long lasting use in harsh environments
- Versatile belt loop closure easily secures around belt loops or carts/equipment/fixtures
- Additional storage includes 2 pockets and 2 elastic loops for quick access to markers, box cutters and other hand tools
- Contoured to fit naturally along the waist
- Tether Included: None
- Colour: Grey



SHB468



Model No.	Mfg. No.	Size	Fits Scanner Faces	Price /Each
SHB468	19180	Small	3" W x 2" H	37.10
SHB469	19181	Large	4" W x 3" H	37.10

## SQUIDS® 3195 CELL PHONE TOOL TETHERING KIT

- Kit includes: (1) 3760 water resistant phone pouch & plus size, (1) 3156 coil low profile tool lanyard with single carabiner
- Patented design to fit and tether one standard or plus sized cell phone without having to remove other aftermarket cell phone cases
- Load Rating: 1 lbs.
- Approved to the ANSI/ISEA 121-2018 standard



Model No. SGN546  
Mfg. No. 19665  
Price/Each \$46.00



## SQUIDS® TOOL TETHERING KIT

- Model SGH805 kit includes a coil lanyard, a 12' (3.7 m) roll of self-adhering tape trap, and six web tool tails
- Model SGH806 kit includes a detachable single carabiner lanyard, a 12' roll (3.7 m) of self-adhering tape trap, and three detachable elastic tool tails
- Model SGH807 kit includes a single carabiner tool lanyard, a 12' (3.7 m) roll of 'self-adhering tape trap, and three swiveling elastic tool tails



SGH806



Model No.	Mfg. No.	Load Rating lbs.	Price /Each
SGH805	19650	2	98.70
SGH806	19651	5	93.30
SGH807	19652	10	98.60

## BOUFFANT CAPS

### NON-WOVEN

- Non-woven polypropylene
- Elasticized band for an optimum fit
- 100% latex-free

SEC376



Model No.	Size	Colour	Qty /Pkg.	Price /Each
SEC375	Medium 18"	White	100	5.70
SEC376	Large 21"	White	100	6.55
SEC377	X-Large 24"	White	100	7.70
SEC378	Large 21"	Blue	100	5.90
SEN410	X-Large 24"	Blue	100	6.95
SHA674	Large 21"	Yellow	100	5.90
SHA675	X-Large 24"	Yellow	100	6.95
SHA676	Large 21"	Green	100	5.90
SHA677	X-Large 24"	Green	100	6.95
SHA678	Large 21"	Red	100	5.90
SHA679	X-Large 24"	Red	100	6.95



### PLEATED

- Lightweight and breathable fabric with elastic band closures provides a comfortable fit
- Practical and cost-effective solution to protect against dry particulates
- Material: Polypropylene



SGF185

Model No.	Size"	Colour	Qty /Pkg.	Price /Each
SGF185	19	White	100	4.85
SGF186	21	White	100	4.95
SGF187	24	White	100	5.15
SGF188	21	Blue	100	4.65
SGF189	24	Blue	100	5.15

## HAIR NETS

- Fine nylon mesh
- Elasticized band for an optimum fit
- Colour: White
- 100% latex-free
- Lint-free



SEC373

Model No.	Size	Colour	Qty /Pkg.	Price /Each
SEC372	Medium 18"	White	100	10.50
SEC373	Large 21"	White	100	11.25
SEC374	X-Large 24"	White	100	12.45
SGW862	Large 21"	Brown	100	11.25

## LIGHTWEIGHT NYLON HAIRNETS

- Light weight netting
- Latex free



SDK998

Model No.	Size"	Colour	Qty /Pkg.	Price /Each
SDK998	22	Brown	144	36.90
SDM177	28	Brown	144	38.30

## HEAVYWEIGHT POLYESTER HAIRNETS

- Latex free



SDN057

Model No.	Size"	Colour	Qty /Pkg.	Price /Each
SDN057	18	White	100	12.00
SDM172	21	White	100	12.10
SDM173	24	White	100	13.50

## BEARD NETS

- Non-woven polypropylene
- Elasticized band for an optimum fit
- Covers beard and mustache
- One size fits all
- 100% latex-free



SEC384



Model No.	Colour	Description	Material	Qty /Pkg.	Price /Each
SEC383	White	One string behind head	Polypropylene	100	5.15
SEC384	White	Two string, behind ears	Polypropylene	100	5.15
SGY078	White	One string behind head	Nylon	100	9.50
SGY079	Brown	One string behind head	Nylon	100	9.50

## BEARD COVERS

- Spunbond polypropylene beard covers
- Latex-free
- Size: 19"



Model No.	Colour	Qty /Bag	Price /Each
SDM179	White	100	5.02

## DISPOSABLE HOOD

- Suitable for a wide range of sizes
- Lightweight and breathable
- Practical and cost-effective solution to protect against dry particulates
- Material: Polypropylene



SGF184

Model No.	Colour	Qty /Pkg.	Price /Each
SGF184	White	100	26.50
SGR152	Blue	100	26.50

## SPRAY SOCK HEAD COVER

- One size fits all
- Material: Cotton
- Colour: White



Model No.	Qty /Pkg.	Price /Each
SGC036	12	20.50



# PROTECTIVE CLOTHING

## CPE SHOE COVERS

- 100% polyethylene
- Elasticized band for an optimum fit
- Flexible material permits easy movement
- No seams are ideal for protection from liquids
- Colour: Blue



Model No.	Size	Qty /Pkg.	Price /Each
SEL089	Large	100	14.95
SGR279	X-Large	100	14.95
SGR280	2X-Large	100	14.95

## SHOE COVERS

- 100% spun-bonded polypropylene
- Elasticized band for an optimum fit
- Flexible material permits easy movement
- Sewn seams offer maximum tear strength
- Skid-free models have a textured sole for improved traction



SEC385



SEC391



SEC389



### REGULAR SOLE

Model No.	Colour	Size	Qty /Pkg.	Price /Each
SEC385	White	Large	100	16.95
SEC386	White	X-Large	100	17.50
SEC389	Blue	Large	100	16.95
SEC390	Blue	X-Large	100	17.50

### SKID-FREE SOLE

Model No.	Colour	Size	Qty /Pkg.	Price /Each
SEC387	White	Large	100	19.00
SEC388	White	X-Large	100	19.75
SEC391	Blue	X-Large	100	19.75

## MICROPOROUS SHOE & BOOT COVERS

- Elasticized band for an optimum fit
- Sewn seams offer maximum tear strength
- Microporous film laminated to a polypropylene substrate
- Offers protection against liquid, dust and light chemical splashes
- Can be used in dry and wet work environments
- Type: Regular Sole
- Dimensions: 17.5" H x 15.5" L



SGZ673



Model No.	Size	Colour	Qty /Pkg.	Price /Each
SGZ673	One Size	White	50	24.99
SGX674	One Size	White	50	49.99

## CAST POLYETHYLENE "CPE" EMBOSSED SHOE COVERS

- Shoe covers help prevent unwanted dust, dirt, and grime from being tracked into sensitive work areas
- Cast polyethylene with textured tread
- 100% latex free



Model No.	Size	Colour	Qty /Bag	Price /Each
SDM191	Large	White	100	55.00
SDM192	X-Large	White	100	57.40

## MULTI-PURPOSE ACRYLIC DISPENSER

- Can be used to hold shoe covers, bouffant caps, hair nets and beard nets
- Single compartment
- Can be wall mounted
- Simple hinged lid for fast and easy replenishment



SGP363



Model No.	Dimensions	Shoe Cover Capacity	Bouffant Capacity	Price /Each
SGP363	11.4"H x 7.1"W x 5.5"D	50 pairs	100 pairs	80.00
SGP364	15.75"H x 11.7"W x 7.8"D	200 pairs	400 pairs	105.00

## SLEEVES

- Microporous film laminated to a polypropylene substrate
- Offers protection against liquid, dust and light chemical splashes
- Can be used in dry and wet work environments
- Elastic at both ends
- Material: Microporous
- Length: 18"
- Sold per pair



Model No.	Colour	Price /Each
SGG328	White	0.79

## POLYETHYLENE SLEEVES

- Disposable
- 0.02 mm polyethylene
- Elastic at both ends
- 100/bag
- Sold per Package



SFU586



Model No.	Length"	Colour	Price /Each
SGZ815	18	White	6.95
SFU586	18	Blue	6.15

## LIGHTWEIGHT VINYL SLEEVES

- Elastic cuffs
- 100% latex free
- Length: 18"
- Components comply with the provisions of the Federal Food, Drug, and Cosmetic Act which allow repeated use in direct contact with food
- Sold per 12 pairs



Model No.	Mfg. No.	Colour	Price /Each
SDL002	DSWV-18	White	20.10
SDL001	DSBV-18	Blue	1.68

## SUPERIOR® BALLISTIC NYLON MESH SLEEVES

- Black nylon mesh is highly durable for superb forearm protection
- Sleeves provide ASTM cut-level 2 protection
- Protects against cut and abrasion
- Breathable comfort
- Adjustable dome-snap closure
- Cut Level: ANSI/ISEA 105 Level 2
- Sold in pairs



Model No.	Price /Each
SFU687	11.30

## SPEEDKNIT™ SLEEVES

- 18" sleeves constructed with a high-gauge blend of HPPE and Tungsten steel with ANSI A7 cut resistance
- Designated thumb holes provide a secure fit
- Stretch-elastic wrist band improves mobility and overall comfort
- REACH Compliant
- OEKO-TEX® Standard 100 Compliant Textiles
- Machine washable and dryable
- Length: 18"
- Colour: Blue
- Material: HPPE



Model No.	Mfg. No.	Cut Level	Price /Each
SHB777	SS2E-03	ASTM ANSI Level A7	58.60
SHB778	SS2E-33	ASTM ANSI Level A5	44.20

## PVC/POLYESTER SLEEVES

- Elastic cuffs
- Length: 18"
- Available in regular and heavy-duty
- Colour: Yellow
- Accepted for use in Canadian food processing facilities
- Sold in pairs



Model No.	Mfg. No.	Description	Price /Each
SAL703	440040	Regular, 0.35 mm	6.74
SAL704	440050	Heavy-duty, 0.45 mm	10.50

## COTTON SLEEVES

- Knitted on both ends prevents debris from entering the sleeve
- Single ply
- Length: 8"
- Colour: Beige
- Sold individually



Model No.	Price /Each
SAQ743	1.05

## KEVLAR® SLEEVES

- Tube style sleeves
- Resists burns, abrasions and cuts
- Available with or without thumb hole
- Available in both double ply and single ply, wide and regular fit
- Other sizes available
- Colour: Yellow
- Made in Canada
- ANSI 2 - Single ply
- ANSI 3 - 2 ply
- Sold in pairs



Model No.	Mfg. No.	Description	Length"	Price /Each
<b>WITHOUT THUMB HOLE</b>				
SAL745	SK-10	Double ply, regular fit	10	10.30
SAL746	SK-10-WIDE	Double ply, wide fit	10	14.00
SAL747	SK-14-1PLY-WIDE	Single ply, wide fit	14	11.50
SAL749	SK-14-WIDE	Double ply, wide fit	14	19.60
SAL750	SK-18	Double ply, regular fit	18	18.50
<b>WITH THUMB HOLE</b>				
SAL738	SK-10H	Double ply, regular fit	10	11.50
SAL743	SK-18H	Double ply, regular fit	18	19.70

## KEVLAR/COTTON BLEND SLEEVE

- Kevlar and cotton fibres are blended together making a softer more comfortable sleeve
- Abrasion-resistant and ANSI level 2 cut protection
- Double ply
- **SDN372:** Thumbhole structure allows sleeves to be tucked into gloves, and provides added protection to the palm
- Sold individually



## Honeywell

Model No.	Mfg. No.	Length"	Price /Each
<b>WITHOUT THUMB HOLE</b>			
SDN373	KVS44-2-18	18	5.72
<b>WITH THUMB HOLE</b>			
SDN372	KVS44-2-18TH	18	6.90

# PROTECTIVE CLOTHING

## POLYETHYLENE APRONS

- Disposable, 0.02 mm thick white polyethylene apron
- This bib style apron is 35" x 46" with waist ties
- 100/pkg.
- Accepted for use in Canadian food processing facilities

SEK351



Model No.	Colour	Price /Each
SEK351	White	13.30
SGR277	Blue	13.30

## LIGHTWEIGHT VINYL APRONS

- Bib style
- Cotton straps for adjustability
- Seamless edges prevent residue and bacteria accumulation
- Dimensions: 36" x 45"
- Thickness: 0.20 mm
- Colour: Blue
- Accepted for use in Canadian food processing facilities



Model No.	Price /Each
SEE888	3.40



## COTTON CANVAS APRONS

- Bib style
- 100% cotton
- Cotton straps for adjustability
- Dimensions: 29" x 36"
- Fabric weight: 10 oz.
- Colour: Natural
- Accepted for use in Canadian food processing facilities



Model No.	Price /Each
SEE852	6.95



## DENIM APRONS

- Bib style
- 100% cotton
- Cotton straps for adjustability
- Includes one chest pocket and three waist pockets
- Dimensions: 28" x 38"
- Fabric weight: 10 oz.
- Colour: Blue
- Accepted for use in Canadian food processing facilities



Model No.	Price /Each
SEE851	8.95



## PVC APRONS

- Green PVC apron with string ties and belly patch
- 20-mil thickness
- 36" W x 50" L



Model No.	Mfg. No.	Price /Each
SDM186	DAV20-36X50	4.09



## LIGHTWEIGHT POLYURETHANE APRONS

- Bib-style apron
- Length 48" x width 35"
- 0.45 mm thick
- Colour: Yellow

Model No.	Price /Each
SAL666	17.20



## NITRILE ON POLYESTER APRONS

- Heavy-duty bib-style apron with metal grommets and polyester ties
- Reliable form of protection against industrial chemical splashes and the handling of corrosive solvents
- Length 48" x width 35"
- 0.45 mm thick
- Accepted for use in Canadian food processing facilities
- Colour: Black

Model No.	Mfg. No.	Price /Each
SAL664	440100	39.20



## FLAME RESISTANT NEOPRENE ON POLYESTER APRONS

- Bib-style apron with metal grommets and polyester ties
- Reliable form of protection against industrial chemical splashes and the handling of corrosive solvents
- Length 48" x width 35"
- 0.45 mm thick
- Accepted for use in Canadian food processing facilities
- Colour: Yellow

Model No.	Mfg. No.	Price /Each
SAL663	440090	39.20





## MICROPOROUS PROTECTIVE CLOTHING

- Sewn ties
- Microporous film laminated to a polypropylene substrate
- Offers protection against liquid, dust and light chemical splashes
- High quality microporous fabric provides comfortable fit and breathability
- Can be used in dry and wet work environments
- Passed penetration tests with motor oil, bleach, isocyanate based paint, sodium hydroxide, sodium hypochlorite and blood
- Applications: Asbestos and lead abatement, clean rooms, dirt and dust, printing, refineries/chemical producers, maintenance, crime scenes, painting
- Anti-static coating helps prevent static discharges from occurring
- EN1149 certified for surface resistivity and ASTM 1670 for blood and blood borne pathogens
- Material: Microporous
- Qty/Case: 100
- Fabric Weight: 1.8 oz/yd<sup>2</sup>



Model No.	Style	W"	Size x L"	Colour	Price /Each
SGW624	Aprons	28	x 36	White	1.60

## DISPOSABLE PONCHO

- Ideal for jobsites and other outdoor events
- Individually packaged for easy and convenient storage
- Heat-sealed seams
- Features attached hood and roomy sleeves
- Material: LDPE
- Size: One Size
- Colour: Blue
- Size: 50" x 80"
- Thickness: 0.02 mm
- Sold/Priced Per: Pack of 10

**Model No. SHB893**  
**Price/Each \$15.95**



## FLAME RESISTANT PVC ON POLYESTER APRONS

- Bib-style apron
- Heavy-duty features oil resistant and fire retardant material
- Rustproof heat sealed grommets
- Seamless edges that prevent buildup of bacteria and residue
- Length 48" x width 36"
- Accepted for use in Canadian food processing facilities
- Colour: Yellow

SAL661



Model No.	Mfg. No.	Description	Thickness mm	Price /Each
SAL660	440060	Regular	0.35	10.80
SAL661	440070	Oil/Fire retardant	0.35	17.00
SAL662	440075	Oil/Fire retardant w/reinforced belly	0.45	20.00

## COAT APRONS

- Blue cast polyethylene apron with thumb hole sleeves and waist ties
- 100% latex free
- 4.5-mil +/- 5-mil thickness
- Colour: Blue
- Qty/Bag: 10



Model No.	Mfg. No.	Size W" x L"	Price /Each
SDM184	CPE-LG-PE	35 x 45	12.20
SDM185	CPE-XL-PE	35 x 48	12.60

## DISPOSABLE APRONS

- Convenient dispenser boxed aprons
- 100% virgin polyethylene
- 2-mil thickness
- 100% latex free
- Components comply with the provisions of the Federal Food, Drug, and Cosmetic Act which allow repeated use in direct contact with food
- Size: 28" W x 46" L
- Colour: White
- Qty/Box: 100

**Model No. SDM183**  
**Mfg. No. DAP2.0-28X46-D**  
**Price/Each \$23.60**



## ISOLATION GOWN

- Polypropylene permits breathability and comfort
- Offers protection against non-hazardous and non-toxic liquids, dust and particles
- Elastic wrists for added protection
- Applications include healthcare, laboratories, pharmaceutical, food processing
- Material: Polypropylene
- Size: One Size
- Colour: White
- Medical Device Class: Non-Medical
- Qty/Case: 100
- Fabric Weight: 0.88oz/m<sup>2</sup> (30 g/m<sup>2</sup>)

**Model No. SGU408**  
**Price/Each \$89.00**



## SPUNBOUND POLYPROPYLENE LAB COAT

- Lightweight lab coat offers the highest levels of protection in lab and medical environments
- Collar, 3 pockets, elastic wrists, 4 front snaps and special breathable materials that provide greater comfort while still protecting workers from hazards
- 40 grams
- Components comply with the provisions of the Federal Food, Drug, and Cosmetic Act which allow repeated use in direct contact with food
- 30 per case

Model No.	Mfg. No.	Size	Colour	Price /Each
SDM153	DLWH-MD	Medium	White	65.20
SDM154	DLWH-LG	Large	White	65.20
SDM155	DLWH-XL	X-Large	White	65.20
SDM156	DLWH-2X	2X-Large	White	65.20
SDM157	DLWH-3X	3X-Large	White	65.20
SDM158	DLWH-4X	4X-Large	White	65.20
SDM159	DLWH-5X	5X-Large	White	65.20



# PROTECTIVE CLOTHING

## POLYPROPYLENE COVERALLS

- Polypropylene permits breathability and comfort
- Offers protection against non-hazardous and non-toxic liquids, dust and particles
- Economical disposable option for protection in grimy work environments
- Elastic wrists, ankles and hood
- Front zipper for optimum fit
- Fabric weight: 45 gsm, 1.33 oz/yd<sup>2</sup>
- 50 Coveralls/Case

**APPLICATIONS:** Food processing, laboratories/ pharmaceutical, warehouses, maintenance, manufacturing/assembly and dusty environments.

SGD166



SEK358



Size	With Hood			Without Hood		
	Model No. Blue	Model No. White	Price /Each	Model No. Blue	Model No. White	Price /Each
Medium	SEK356	SGM425	2.95	SGS887	SGD164	2.59
Large	SEK357	SGM426	2.95	SGS888	SGD165	2.59
X-Large	SEK358	SGM427	2.95	SGS889	SGD166	2.59
2X-Large	SEK359	SGM428	2.95	SGS890	SGD167	2.59
3X-Large	SEK360	SGM429	2.95	SGS891	SGD168	2.69
4X-Large	SEK361	SGM430	2.95	SGS892	SGD169	2.75
5X-Large	SEK362	SGM431	2.95	SGS893	SGD170	2.79

## PREMIUM POLYPROPYLENE COVERALLS

- Polypropylene permits breathability and comfort
- Offers protection against non-hazardous and non-toxic liquids, dust and particles
- Economical disposable option for protection in grimy work environments
- Elastic wrists, ankles and hood
- Heavy-duty front zipper for optimum fit
- Protective front zipper flap
- Features front left breast pocket
- Fabric weight: 60 gsm, 1.77 oz/yd<sup>2</sup>
- Colour: Light blue
- 50 coveralls/case

**APPLICATIONS:** Food processing, laboratories/ pharmaceutical, warehouses, maintenance, manufacturing/assembly and dusty environments.



SEK372



Model No.	Size	Price /Each
SEK370	Medium	3.49
SEK371	Large	3.49
SEK372	X-Large	3.49
SEK373	2X-Large	3.51
SEK374	3X-Large	3.60
SEK375	4X-Large	3.69
SEK376	5X-Large	3.70

## SMS HOODED COVERALLS

- Three layer polypropylene SMS (spun-bonded, melt-blown, spun-bonded)
- Offers protection against dry particles and water-based liquids in work environments with hazardous or non-hazardous contaminants
- Double outer layer offers greater protection against tearing and abrasion
- Lightweight and flexible fabric permits superior comfort and breathability
- Anti-static coating helps prevent static discharges from occurring
- Fabric weight: 1.5 oz/yd<sup>2</sup> 50 gsm
- 25 coveralls/case

**APPLICATIONS:** Food processing, laboratories, pharmaceutical, light oil and grease, maintenance, manufacturing/assembly and refineries/chemical producers

SGX189



SGX195



Model No. White	Model No. Blue	Size	Price /Each
SGX189	SGX195	Medium	6.09
SGX190	SGX196	Large	6.09
SGX191	SGX197	X-Large	6.09
SGX192	SGX198	2X-Large	6.09
SGX193	SGX199	3X-Large	6.09
SGX194	SGX200	4X-Large	6.25

## MICROPOROUS COVERALLS

- Zipper front with storm flap, attached hood, elastic wrists and ankles
- Microporous film laminated to a polypropylene substrate
- Offers protection against liquid, dust, and light chemical splashes
- High quality, lightweight, microporous fabric provides comfortable fit and breathability
- Can be used in dry and wet work environments
- Colour: White
- Style: Hooded Coveralls
- Fabric Weight: 1.41 oz/yd<sup>2</sup> (48 g/m<sup>2</sup>)
- Case Qty: 50

**Applications:** Food processing, laboratories and pharmaceutical industries, warehouses, maintenance, manufacturing and assembly and dusty environments



SGM433



Model No.	Size	Price /Each
SGM432	Medium	4.95
SGM433	Large	4.95
SGM434	X-Large	4.95
SGM435	2X-Large	4.95
SGM436	3X-Large	4.95
SGM437	4X-Large	4.95
SGM438	5X-Large	4.95

## MICROPOROUS PROTECTIVE CLOTHING

Microporous film laminated to a polypropylene substrate  
 Offers protection against liquid, dust and light chemical splashes  
 High quality microporous fabric provides comfortable fit and breathability  
 Can be used in dry and wet work environments  
 Passed penetration tests with motor oil, bleach, isocyanate based paint,  
 sodium hydroxide, sodium hypochlorite and blood  
 Anti-static coating helps prevent static discharges from occurring

## APPLICATIONS

Asbestos and lead abatement, clean rooms,  
 dirt and dust, printing, refineries chemical producers,  
 maintenance, crime scenes and painting.

## MICROPOROUS DISPOSABLE SHIRTS

- Snap front and serged seams
- 50 Shirts/Case

SGY255



Model No.	Size	Price /Each
SGY255	Small	4.45
SGY256	Medium	4.45
SGY257	Large	4.45
SGY258	X-Large	4.45
SGY259	2X-Large	4.45
SGY260	3X-Large	4.45
SGY261	4X-Large	4.45

## MICROPOROUS LAB COATS

- Plastic snaps, 2 pockets, collar
- 30 Coats/Case

SGW617



Model No.	Size	Price /Each
SGW617	Small	4.30
SGW618	Medium	4.35
SGW619	Large	4.45
SGW620	X-Large	4.70
SGW621	2X-Large	4.80
SGW622	3X-Large	4.95
SGW623	4X-Large	5.50

## MICROPOROUS DISPOSABLE PANTS

- Elastic waist and serged seams
- 50 Pants/Case

SGY249



Model No.	Size	Price /Each
SGY249	Small	3.85
SGY250	Medium	3.85
SGY251	Large	3.85
SGY252	X-Large	3.85
SGY253	2X-Large	3.85
SGY254	3X-Large	3.85

## PREMIUM MICROPOROUS COVERALLS

- Zipper front with storm flap, elastic wrists and ankles
- Microporous film laminated to a polypropylene substrate
- Offers protection against liquid, dust and light chemical splashes
- High quality microporous fabric provides comfortable fit and breathability
- Can be used in dry and wet work environments
- Passed penetration tests with motor oil, bleach, isocyanate based paint, sodium hydroxide, sodium hypochlorite and blood
- Anti-static coating helps prevent static discharges from occurring
- EN1149 certified for surface resistivity and ASTM 1670 for blood and blood borne pathogens
- Colour: White
- Style: Coveralls
- Fabric Weight: 1.8 oz/yd<sup>2</sup>
- Case Qty: 25

**Applications:** Asbestos and lead abatement, clean rooms, dirt and dust, printing, refineries/chemical producers, maintenance, crime scenes, painting

Model No.	Size	Price /Each
<b>HOODED COVERALLS</b>		
SGW457	Small	6.60
SGW458	Medium	6.60
SGW459	Large	6.60
SGW460	X-Large	6.60
SGW461	2X-Large	6.60
SGW462	3X-Large	6.95
SGW463	4X-Large	7.40
<b>COLLARED COVERALLS</b>		
SGW450	Small	6.25
SGW451	Medium	6.25
SGW452	Large	6.25
SGW453	X-Large	6.25
SGW454	2X-Large	6.25
SGW455	3X-Large	6.60
SGW456	4X-Large	6.75



SGW452



SGW458



# PROTECTIVE CLOTHING

## TYVEK® 400 PROTECTIVE CLOTHING

• Serged seams

**Applications:** Asbestos removal, paint spraying, light splashes, maintenance, general clean-up, dry particulate protection.



SAV192



SAV174









SAV176



SAV183



SAV190

	Model No.	Mfg. No.	Size	Qty /Case	Price /Each
 <p><b>SHIRT</b> Snap front</p>	SAV183	TY303S-S	Small	50	8.35
	SAV182	TY303S-M	Medium	50	8.35
	SAV181	TY303S-L	Large	50	8.35
	SAV184	TY303S-XL	X-Large	50	8.35
	SAV178	TY303S-2XL	2X-Large	50	8.85
	SAV179	TY303S-3XL	3X-Large	50	9.38
	SAV180	TY303S-4XL	4X-Large	50	10.20
	 <p><b>PANTS</b> Elastic waist</p>	SAV190	TY350S-S	Small	50
SAV189		TY350S-M	Medium	50	6.80
SAV188		TY350S-L	Large	50	6.80
SAV191		TY350S-XL	X-Large	50	6.80
SAV185		TY350S-2XL	2X-Large	50	7.21
SAV186		TY350S-3XL	3X-Large	50	7.64
SAV187		TY350S-4XL	4X-Large	50	8.25
 <p><b>PULLOVER HOOD</b> Elastic face, shoulder length</p>		SAV193	TY657S	One-Size	100
 <p><b>LAB COAT</b> Snaps 2 pockets, collar</p>	SAV174	TY212S-S	Small	30	9.29
	SAV173	TY212S-M	Medium	30	9.29
	SAV172	TY212S-L	Large	30	9.29
	SAV175	TY212S-XL	X-Large	30	9.29
	SAV169	TY212S-2XL	2X-Large	30	9.90
	SAV170	TY212S-3XL	3X-Large	30	10.50
	SAV171	TY212S-4XL	4X-Large	30	11.30
	 <p><b>APRON</b> Bound ties</p>	SAV176	TY273B	28" x 36" Long	100
 <p><b>SLEEVES</b> Elastic at both ends</p>	SAV192*	TY500S	18" Long	100 pairs	1.84
 <p><b>SHOE/BOOT COVER</b> Elastic top</p>	SA174*	TY450S-LG	8 1/4" High, O/S, pr.	100 pairs	187.00
	SA173*	TY454S-WH	17" High, O/S, pr.	50 pairs	145.50

\*Sold per pair

## TYVEK® 800 J COVERALLS

- New limited-use Type 3 chemical protective garment that combines resistance to pressurized jets of low-concentration, water-based, inorganic chemicals with protection, durability and freedom of movement
- Designed for work in very humid applications requiring chemical, liquid and/or oil protection
- Good for use in industrial cleaning, petrochemical installations, sewage and maintenance
- Protects against Sodium Hydroxide (50%), Bleach (15%) and Sulfuric Acid (30%)
- Seams are both sewn and taped to provide strong chemical resistance against heavy liquid splashes and tough seam stress
- Additional taping of cuffs, ankles, hood and zipper flap required to achieve Type 3 liquid tightness
- Chemical protective clothing, category III, Type 3-B, 4-B, 5-B and 6-B
- Colour: White



Model No.	Mfg. No.	Size	Qty /Case	Price /Each
SFQ731	TJ198T-S	Small	25	19.90
SFQ732	TJ198T-M	Medium	25	19.90
SFQ733	TJ198T-L	Large	25	19.90
SFQ734	TJ198T-XL	X-Large	25	19.90
SFQ735	TJ198T-2XL	2X-Large	25	21.10
SFQ736	TJ198T-3XL	3X-Large	25	22.80

## TYVEK® 400 COVERALLS





- The best balance of protection, durability and comfort
- Inherent barrier protection against dry particulate hazards
- Even after abrasion, stops sub-micron particles better than reusable garments
- Colour: White

### Applications:

General maintenance/operations, spray painting, lead abatement, environmental cleanup, asbestos abatement, agriculture, food processing, mold remediation, micro crystalline silica.



SAS042

	Model No.	Mfg. No.	Size	Qty /Case	Price /Each
 <p><b>COVERALLS</b> Serged seams, collar, front zipper closure</p>	SAS028	TY120S-M	Medium	25	11.60
	SAS029	TY120S-L	Large	25	11.60
	SAS030	TY120S-XL	X-Large	25	11.60
	SAS031	TY120S-2XL	2X-Large	25	12.20
	SAS032	TY120S-3XL	3X-Large	25	13.00
	SAS033	TY120S-4XL	4X-Large	25	14.00
 <p><b>COVERALLS</b> Serged seams, collar, front zipper closure, elastic wrists and ankles</p>	SAS035	TY125S-M	Medium	25	13.10
	SAS036	TY125S-L	Large	25	13.10
	SAS037	TY125S-XL	X-Large	25	13.10
	SAS038	TY125S-2XL	2X-Large	25	13.80
	SAS039	TY125S-3XL	3X-Large	25	14.70
	SAS040	TY125S-4XL	4X-Large	25	15.80
 <p><b>HOODED COVERALLS</b> Serged seams, attached hood, front zipper closure, elastic wrists and ankles</p>	SAS042	TY127S-M	Medium	25	14.00
	SAS043	TY127S-L	Large	25	14.00
	SAS044	TY127S-XL	X-Large	25	14.00
	SAS045	TY127S-2XL	2X-Large	25	14.80
	SAS046	TY127S-3XL	3X-Large	25	15.70
	SAS047	TY127S-4XL	4X-Large	25	17.00
 <p><b>HOODED COVERALL w/BOOTS</b> Zipper front, attached hood, boots and elastic wrists</p>	SAV166	TY122S-M	Medium	25	14.20
	SAV165	TY122S-L	Large	25	14.20
	SAV168	TY122S-XL	X-Large	25	14.20
	SAV162	TY122S-2XL	2X-Large	25	15.00
	SAV163	TY122S-3XL	3X-Large	25	15.90
	SAV164	TY122S-4XL	4X-Large	25	17.20

## TYVEK® 400 D COVERALLS

- The ideal balance of protection, durability, and comfort for workers
- Unique zoned garment designed specifically for composite manufacturing applications
- Front zone features Tyvek® fabric to provide excellent durability and an inherent barrier to fine particles
- Rear zone features ProShield® fabric to help increase breathability for reduced heat stress and advanced worker comfort
- Comfort fit design helps to enable a greater range of movement while providing a more tailored fit
- Thumb loops keep the sleeves in place while donning gloves or reaching
- Respirator-fit hood with elastic around the face opening
- Longer zipper extends to chin for complete coverage of the neck area
- Unique outside serged seams provide better liquid mist holdout



SEH058

Model No.	Mfg. No.	Size	Qty /Case	Price /Each
SEH058	TD127-M	Medium	25	13.00
SEH059	TD127-L	Large	25	13.00
SEH060	TD127-XL	X-Large	25	13.00
SEH061	TD127-2X	2X-Large	25	13.80
SEH062	TD127-3X	3X-Large	25	14.60
SEH063	TD127-4X	4X-Large	25	15.80

# PROTECTIVE CLOTHING

## COMBINAISONS PROSHIELD® 10

- Soft, breathable, comfortable and lightweight spunbond meltblown spunbond (SMS) material
- Feature a proprietary comfort fit design that is specially engineered for enhanced worker range of motion and durability in use
- Provides protection from dirt, grime, and non-hazardous dry particles

**Applications:** Food processing, general maintenance, janitorial, visitor garments, hospitals and situations where you want to avoid nuisance contamination.



	Model No.	Mfg. No.	Description	Qty /Case	Price /Each
<b>COVERALL</b> Zipper front, elastic wrists and ankles	SEJ892	PB125SBU-MD	Medium, Blue	25	4.43
	SEJ893	PB125SBU-LG	Large, Blue	25	4.43
	SEJ894	PB125SBU-XL	X-Large, Blue	25	4.43
	SEJ895	PB125SBU-2X	2X-Large, Blue	25	4.70
	SEJ896	PB125SBU-3X	3X-Large, Blue	25	4.98
	SEJ897	PB125SBU-4X	4X-Large, Blue	25	5.38
<b>HOODED COVERALL</b> Zipper front, attached hood, elastic wrists and ankles	SEJ899	PB127SBU-MD	Medium, Blue	25	4.75
	SEJ900	PB127SBU-LG	Large, Blue	25	4.75
	SEJ901	PB127SBU-XL	X-Large, Blue	25	4.75
	SEJ902	PB127SBU-2X	2X-Large, Blue	25	5.03
	SEJ903	PB127SBU-3X	3X-Large, Blue	25	5.34
	SEJ904	PB127SBU-4X	4X-Large, Blue	25	5.76
<b>LAB COAT</b> Snaps 2 pockets, collar	SDL501	PB212SBU-M	Medium, Blue	30	3.79
	SDL502	PB212SBU-L	Large, Blue	30	3.79
	SDL503	PB212SBU-XL	X-Large, Blue	30	3.79
	SDL504	PB212SBU-2XL	2X-Large, Blue	30	4.02
	SDL505	PB212SBU-3XL	3X-Large, Blue	30	4.26



SEJ899

## PROSHIELD® 60 COVERALLS

- Effective barrier against a variety of common industrial aerosols and liquids
- Proprietary microporous technology
- Colour: White

**Applications:** Anywhere general protective coveralls are used from dirty jobs to paint spraying to agricultural applications.



SN894

	Model No.	Mfg. No.	Size	Qty /Case	Price /Each
<b>COVERALL</b> Zipper front, collar	SN880	NG120S-S	Small	25	8.93
	SN881	NG120S-M	Medium	25	8.93
	SN882	NG120S-L	Large	25	8.93
	SN883	NG120S-XL	X-Large	25	8.93
	SN884	NG120S-2XL	2X-Large	25	8.93
	SN885	NG120S-3XL	3X-Large	25	9.46
<b>COVERALL</b> Zipper front, elastic wrists and ankles	SN886	NG120S-4XL	4X-Large	25	10.30
	SN887	NG125S-S	Small	25	9.90
	SN888	NG125S-M	Medium	25	9.90
	SN889	NG125S-L	Large	25	9.90
	SN890	NG125S-XL	X-Large	25	9.90
	SN891	NG125S-2XL	2X-Large	25	9.90
<b>HOODED COVERALL</b> Zipper front, attached hood (respirator fit), elastic wrists and ankles	SN892	NG125S-3XL	3X-Large	25	10.50
	SN893	NG125S-4XL	4X-Large	25	11.30
	SN894	NG127S-S	Small	25	10.60
	SN895	NG127S-M	Medium	25	10.60
	SN896	NG127S-L	Large	25	10.60
	SN897	NG127S-XL	X-Large	25	10.60
<b>HOODED COVERALL</b> Zipper front, attached hood (respirator fit), elastic wrists and ankles	SN898	NG127S-2XL	2X-Large	25	10.60
	SN899	NG127S-3XL	3X-Large	25	11.90
	SN900	NG127S-4XL	4X-Large	25	12.80



## TYCHEM® 2000 SERIES COVERALLS

- Polyethylene-coated Tyvek® fabric
- Flexible, durable and lightweight
- Light liquid splash protection
- Provides at least 30 minutes of protection against 42 chemical challenges
- Ideal for Petroleum; pulp and paper; food and chemical processing; and pharmaceutical
- Colour: Yellow for high visibility



SAV113

	Model No.	Mfg. No.	Description	Qty /Case	Price /Each
	<b>SAV091</b>	QC122SYL-MD	Medium	12	<b>21.00</b>
	<b>SAV090</b>	QC122SYL-LG	Large	12	<b>21.00</b>
	<b>SAV093</b>	QC122SYL-XL	X-Large	12	<b>21.00</b>
	<b>SAV087</b>	QC122SYL-2XL	2X-Large	12	<b>22.20</b>

**HOODED COVERALL**  
Zipper front, elastic wrists, attached boots

	Model No.	Mfg. No.	Description	Qty /Case	Price /Each
	<b>SAV113</b>	QC127SYL-MD	Medium	12	<b>18.80</b>
	<b>SAV112</b>	QC127SYL-LG	Large	12	<b>18.80</b>
	<b>SAV115</b>	QC127SYL-XL	X-Large	12	<b>18.80</b>
	<b>SAV109</b>	QC127SYL-2XL	2X-Large	12	<b>19.90</b>

**HOODED COVERALL**  
Zipper front, elastic wrists and ankles

## TYCHEM® 4000 SERIES COVERALLS

- Tychem® 4000 is laminated to Tyvek® fabric
- Offers dependable protection against a broad spectrum of chemicals
- Provides great protection against hazardous particles and liquids
- Rugged and durable strong fabric, reducing the risk of tears and abrasion
- Bound seams
- Colour: White

### Applications:

Petrochemical manufacturing, waste management, industrial plants, hazardous material response, emergency medical response, paint spraying, radioactive environments, environmental cleanups and other emergency services. Commonly used in domestic preparedness for protection from biohazards, several toxic industrial chemicals and some chemical warfare agents.



SA194

	Model No.	Mfg. No.	Description	Qty /Case	Price /Each
	<b>SAS056</b>	SL125B-M	Medium	12	<b>36.30</b>
	<b>SAS057</b>	SL125B-L	Large	12	<b>36.30</b>
	<b>SAS058</b>	SL125B-XL	X-Large	12	<b>36.30</b>
	<b>SAS059</b>	SL125B-2XL	2X-Large	12	<b>38.50</b>
	<b>SAS060</b>	SL125B-3XL	3X-Large	12	<b>40.80</b>
	<b>SAS061</b>	SL125B-4XL	4X-Large	12	<b>44.00</b>

**COVERALL**  
Bound seams, collar, front zipper, storm flap, elastic wrists and ankles

	Model No.	Mfg. No.	Description	Qty /Case	Price /Each
	<b>SA194</b>	SL127B-M	Medium	12	<b>36.70</b>
	<b>SA193</b>	SL127B-L	Large	12	<b>36.70</b>
	<b>SA196</b>	SL127B-XL	X-Large	12	<b>36.70</b>
	<b>SC252</b>	SL127B-2XL	2X-Large	12	<b>38.90</b>
	<b>SC253</b>	SL127B-3XL	3X-Large	12	<b>41.20</b>
	<b>SC254</b>	SL127B-4XL	4X-Large	12	<b>44.50</b>

**HOODED COVERALL**  
Bound seams, attached hood (respirator fit), front zipper, storm flap, elastic wrists and ankles

## TYCHEM® 6000 SERIES COVERALLS

- A proprietary barrier laminated to a Tyvek® substrate
- Strong and lightweight, with broad chemical barrier
- Used for protection from chemical warfare agents
- Widely used by military first responders for weapons of mass destruction situations
- Taped seams, attached hood (respirator fit), front zipper closure, storm flap, elastic wrists and attached socks
- Colour: Grey
- Ankle Type: Sock
- Available in sizes small to 4X-Large



SAS200

**Applications:** Because Tychem® 6000 garments are only available with respiratory fit hood, storm flap and taped seams, these garments are intended for domestic preparedness situations where the potential for exposure to chemical warfare agents exists. When the hazard assessment consists of potential for exposure to the FBI's Toxic Industrial Chemicals most likely to be used in a terrorist threat, we suggest consideration of Tychem® CPF 3 or higher protection since permeation data is available on a much broader spectrum of chemicals including chemical warfare agents.

Model No.	Mfg. No.	Size	Qty /Case	Price /Each
<b>SAS200</b>	TF169T-M	Medium	6	<b>108.00</b>
<b>SAS201</b>	TF169T-L	Large	6	<b>108.00</b>
<b>SAS202</b>	TF169T-XL	X-Large	6	<b>108.00</b>
<b>SAS203</b>	TF169T-2XL	2X-Large	6	<b>115.00</b>

# PROTECTIVE CLOTHING

## A20 COVERALLS

- Breathable, Particle Protection Apparel
- Patented Microforce® barrier SMS fabric
- Coveralls have patented Reflex® design which is 7 1/2 times less likely to rip out than ANSI minimums and provides 12% more chest room and 6% longer body length
- Seamless front for more protection
- Zipper flap, elastic back
- NFPA 99 compliant antistatic material
- Available in 3X and 4X sizes

**Applications:** Laboratories, remediation, decontamination modesty garment, pesticides and heavy dust environments.



SAQ362

	Model No.	Mfg. No.	Size	Colour	Qty /Case	Price /Each
<b>COVERALLS</b>						
	SAQ362	58532	Medium	Denim Blue	24	9.94
	SAQ363	58533	Large	Denim Blue	24	9.36
	SAQ364	58534	X-Large	Denim Blue	24	9.36
	SAQ365	58535	2X-Large	Denim Blue	24	9.94
	SAQ368	58502	Medium	Denim Blue	24	9.94
	SAQ369	58503	Large	Denim Blue	24	9.94
	SAQ370	58504	X-Large	Denim Blue	24	9.94
	SAQ371	58505	2X-Large	Denim Blue	24	10.60
	SEA093	49112	Medium	White	24	11.00
	SEA094	49113	Large	White	24	11.00
	SEA095	49114	X-Large	White	24	11.00
	SEA096	49115	2X-Large	White	24	11.20
	SGCS86	49116	3X-Large	White	24	11.20
	SGCS87	49117	4X-Large	White	24	12.00
<b>LAB COAT</b>						
	SAQ755	10019	Medium	White	25	9.44
	SAQ756	10029	Large	White	25	9.44
	SAQ757	10039	X-Large	White	25	9.44

## A35 COVERALLS

- Liquid and particulate barrier
- Microporous film laminate

**Applications:** Liquid handling, pressure washing, maintenance, general manufacturing.



SFU799

	Model No.	Mfg. No.	Size	Colour	Qty /Case	Price /Each
	SFU799	38937	Medium	White	25	7.92
	SFU800	38938	Large	White	25	7.92
	SFU801	38939	X-Large	White	25	7.92
	SFU802	38941	2X-Large	White	25	7.92
	SFU803	38942	3X-Large	White	25	8.38
	SFU804	38943	4X-Large	White	25	8.86

## A40 COVERALLS

- Liquid and particle protection
- Breathable microporous film laminate
- Passes ASTM F1670 testing for penetration of blood and body fluids
- Meets ANSI/ISEA 101-1996 sizing standard
- NFPA 99 compliant antistatic material

**Applications:** Fiberglass manufacturing, tank cleaning, utilities, liquid handling, pressure washing, and maintenance/general manufacturing.



SAQ759

	Model No.	Mfg. No.	Size	Colour	Qty /Case	Price /Each
	SAQ759	44302	Medium	White	25	9.36
	SAQ760	44303	Large	White	25	9.36
	SAQ761	44304	X-Large	White	25	9.36
	SAQ762	44305	2X-Large	White	25	9.36
	SAQ763	44306	3X-Large	White	25	9.36
	SAQ764	44307	4X-Large	White	25	10.60
	SAQ771	44322	Medium	White	25	10.80
	SAQ772	44323	Large	White	25	10.80
	SAQ773	44324	X-Large	White	25	10.80
	SAQ774	44325	2X-Large	White	25	10.80
	SAQ775	44326	3X-Large	White	25	11.50
	SAQ776	44327	4X-Large	White	25	11.90

## A45 LIQUID/PARTICLE SURFACE PREP & PAINT COVERALLS

- Designed to move with you while protecting in work environments where hazardous or non-hazardous contaminants may be present
- Ideal for use in surface prep, paint prep, and paint application
- Protects against isocyanates and chromate dust
- Silicone free
- Respirator fit hood design
- Water resistant zipper
- Serged seams
- Passes NFPA 99 for antistatic materials
- Material: Microporous
- Colour: White



Model No.	Mfg. No.	Size	Price /Each
SDS883	41503	Small	13.50
SDS884	41504	Medium	14.50
SDS885	41505	Large	14.50
SDS886	41506	X-Large	14.50
SDS887	41507	2X-Large	14.50
SDS888	41508	3X-Large	15.30
SDS889	41509	4X-Large	16.00
SDS890	41510	5X-Large, 6X-Large	16.60



SDS883

## A60 COVERALLS

- Bloodborne pathogen and chemical splash protection apparel
- Patented 3-layer fabric construction: middle layer of microporous film allows heat and sweat vapour to escape, yet protects against many dry particulates and liquids, even under pressure
- Outer layer - cloth like, yet tough and abrasion-resistant spunbond polypropylene
- Coveralls have patented Reflex design which is 7 1/2 times less likely to rip out than ANSI minimums and provides 12% more chest room and 6% longer body length
- Seamless front for more protection
- Resistant to many liquid and dry particulate chemicals
- Passes ASTM F1670/F1671 testing for penetration of blood, body fluids and blood borne pathogens



**Applications:** Emergency medical response, crime scene clean-up, embalming/forensics, tank cleaning, fiberglass manufacturing, animal research.

Model No.	Mfg. No.	Size	Colour	Qty /Case	Price /Each	
	SAQ424	45022	Medium	Denim Blue	24	15.50
	SAQ425	45023	Large	Denim Blue	24	15.50
	SAQ426	45024	X-Large	Denim Blue	24	15.50
	SAQ427	45025	2X-Large	Denim Blue	24	17.60
	SAQ428	45026	3X-Large	Denim Blue	20	18.40
	SAQ429	45027	4X-Large	Denim Blue	20	19.20





SAQ425

## A70 COVERALLS

- Chemical spray protection apparel
- Coveralls have patented Reflex design which is 7 1/2 times less likely to rip out than ANSI minimums and provides 12% more chest room and 6% longer body length
- Softer and quieter fabric
- Taped seams, extra-long zipper
- A wick-away lining for enhanced comfort
- Resistant to dry particulates and liquids under pressure
- Resistant to many liquid and dry particulate chemicals
- Resistant to blood and body fluids and blood borne pathogens
- NFPA 99 compliant antistatic material



**Applications:** Hazardous waste remediation, environmental clean-up, petrochemical/oil refining, acid/caustic handling, biohazard clean-up, tank cleaning and pharmaceutical manufacturing.

Model No.	Mfg. No.	Size	Colour	Qty /Case	Price /Each	
	SAQ454	09812	Medium	Yellow	12	22.00
	SAQ455	09813	Large	Yellow	12	22.00
	SAQ456	09814	X-Large	Yellow	12	22.00
	SAQ457	09815	2X-Large	Yellow	12	23.30
	SAQ458	09816	3X-Large	Yellow	12	24.70
	SAQ459	09817	4X-Large	Yellow	12	26.20
	SAQ460	00682	Medium	Yellow	12	24.50
	SAQ461	00683	Large	Yellow	12	24.50
	SAQ462	00684	X-Large	Yellow	12	24.50
	SAQ463	00685	2X-Large	Yellow	12	25.90
	SAQ464	00686	3X-Large	Yellow	12	27.50
	SAQ465	00687	4X-Large	Yellow	12	29.10



SAQ454



SAQ460



# GENERAL RAINWEAR

## RZ PONCHOS

- 0.10 mm material thickness
- 100% unsupported single-ply PVC material
- Ultrasonically welded seams
- One size fits all



Model No.	Colour	Price /Each
SEH121	Yellow	5.95



## RZ100 RAIN SUITS

- 0.35 mm material thickness
- Yellow triple layer PVC/Polyester/PVC material
- Jacket features storm flap, dome snaps, two patch pockets, corduroy collar and detachable hood
- Cape back and underarm vents
- Bib overall pants feature non-conductive fasteners, fly front and adjustable suspenders
- Ankle and cuff take-up snaps
- Adjustable waist snaps
- Ultrasonically welded seams

Model No.	Size	Price /Each
SEH078	Small	20.45
SEH079	Medium	20.45
SEH080	Large	20.45
SEH081	X-Large	20.45
SEH082	2X-Large	20.45
SEH083	3X-Large	20.95
SEH084	4X-Large	21.25



## RZ200 LONG COATS

- 0.35 mm material thickness
- Yellow triple layer PVC/Polyester/PVC material
- 47" long coat features storm flap, dome snaps, two patch pockets, corduroy collar and detachable hood
- Cape back and underarm vents
- Cuff take-up snaps
- Fire retardant
- Ultrasonically welded seams

Model No.	Size	Price /Each
SEH085	Small	17.55
SEH086	Medium	17.55
SEH087	Large	17.55
SEH088	X-Large	17.55
SEH089	2X-Large	17.55
SEH090	3X-Large	17.55
SEH091	4X-Large	18.25



## RZ300 RAIN SUITS

- 0.20 mm material thickness
- Unsupported yellow PVC material with an embossed finish
- Jacket features storm flap and dome snaps, two patch pockets and a detachable hood
- Bib overall pants feature fly front
- Ankle and cuff take-up snaps
- Non-conductive fasteners
- Ultrasonically welded seams

Model No.	Size	Price /Each
SEH092	Small	19.25
SEH093	Medium	19.25
SEH094	Large	19.25
SEH095	X-Large	19.25
SEH096	2X-Large	19.50
SEH097	3X-Large	19.50
SEH098	4X-Large	20.50



## RZ500 FLAME RESISTANT RAIN SUITS

- 0.35 mm material thickness
- Yellow tear-resistant PVC/Nylon/PVC material
- Lightweight material offers greater flexibility and comfort
- Jacket comes with storm flap, dome snap fasteners, two patch pockets and detachable hood
- Cape back vent on jacket with underarm vents
- Bib overalls feature fly front, adjustable suspenders and adjustable waist snaps
- Ankle and cuff take-up snaps
- Non-conductive fasteners
- Ultrasonically welded seams
- Compliant with CSA testing under CAN/CGSB standard 155.20 for flame resistance of textiles

Model No.	Size	Price /Each
SEH099	Small	31.75
SEH100	Medium	31.75
SEH101	Large	31.75
SEH102	X-Large	31.75
SEH103	2X-Large	31.75
SEH104	3X-Large	32.75
SEH105	4X-Large	33.75



## RZ1000 HIGH-VISIBILITY RAIN SUITS

- 100% 300D polyester oxford material
- Features ID pocket, snaps, zipper, two patch pockets and detachable hood
- Adjustable wrist cuffs
- Comes with adjustable suspenders
- Adjustable ankle & waist snaps
- Colour: High Visibility Yellow
- Reflective Stripe Colour: Silver
- Standard(s) Met: CSA Z96 Class 3 - Level 2



### JACKETS & BIB PANTS

Model No.	Size	Price /Each
SGP356	Small	77.75
SGP357	Medium	77.75
SGP358	Large	77.75
SGP359	X-Large	77.75
SGP360	2X-Large	77.75
SGP361	3X-Large	79.25
SGP362	4X-Large	80.85



SGP356

### JACKETS ONLY

Model No.	Size	Price /Each
SGM194	Small	52.25
SGM195	Medium	52.25
SGM196	Large	52.25
SGM197	X-Large	52.25
SGM198	2X-Large	52.25
SGM199	3X-Large	53.75
SGM200	4X-Large	54.75



SGM194

### BIB PANTS ONLY

Model No.	Size	Price /Each
SGM201	Small	35.50
SGM202	Medium	35.50
SGM203	Large	35.50
SGM204	X-Large	35.50
SGM205	2X-Large	35.50
SGM206	3X-Large	36.25
SGM207	4X-Large	36.95



SGM201

## OPEN ROAD FR PVC RAIN SUITS

- Entry level incidental flame contact protective garment
- Good splash protection and chemical resistance due to sandwich construction
- 0.35 mm FR treated PVC/polyester material
- Micro welded seams to prevent leaking through the garment
- Ideal for low risk hazard, FR required job sites
- Tested in accordance with test method CAN/CGSB-4.2 No.27.10 & ASTM D6413 flame resistance, self extinguishing for momentary contact with open flame
- 2" yellow prism reflective tape
- Generous sizing for comfort and freedom of movement
- Welded seams for durability and waterproofness
- ESR nylon snap closure systems
- Cotton corduroy collar on jacket
- Removable hood included
- Bib pants with adjustable waist panel and ESR suspenders
- Colour: Orange
- Certification: CSA Z96-09 Class 1, Level FR



Model No.	Mfg. No.	Size	Price /Each
SDP048	2110FR-S	Small	73.30
SDP049	2110FR-M	Medium	73.30
SDP050	2110FR-L	Large	73.30
SDP051	2110FR-XL	X-Large	73.30
SDP052	2110FR-2XL	2X-Large	73.30
SDP053	2110FR-3XL	3X-Large	73.30

## MINER 49ER MINING SUITS

- Heavy risk chemical splash protection
- Heat and flame incidental contact protection
- High abrasion contact protection
- Heavy duty neoprene with nylon/PU backing
- 100% waterproof
- Seams are heat sealed and taped
- Resistant to acids, chemicals, oils and solvents
- Excellent puncture, tear and abrasion resistance
- Generous sizing for working ease
- Ideal for petro chemical processing, mining, oil and gas
- 2" reflective tape strategically placed front and back



### JACKETS

- Durable nickel plated brass buttons
- D Ring slot on back (also provides venting)

### BIB PANTS

- Heavy duty elastic suspenders
- Double bib design with inner pouch and pen holder

Model No.	Mfg. No.	Size	Price /Each
<b>JACKETS</b>			
SDP035	5200J-S	Small	202.00
SDP036	5200J-M	Medium	202.00
SDP037	5200J-L	Large	202.00
SDP038	5200J-XL	X-Large	202.00
SDP039	5200J-2XL	2X-Large	210.00
SDP040	5200J-3XL	3X-Large	210.00
<b>BIB PANTS</b>			
SDP041	5200P-S	Small	202.00
SDP042	5200P-M	Medium	202.00
SDP043	5200P-L	Large	202.00
SDP044	5200P-XL	X-Large	202.00
SDP045	5200P-2XL	2X-Large	210.00
SDP046	5200P-3XL	3X-Large	210.00
<b>HOOD</b>			
SDP047	5212	-	22.60

## RZ600 FLAME RESISTANT RAIN SUITS

- 0.35 mm material thickness
- Yellow PVC/polyester/PVC material
- Jacket comes with storm flap, dome snaps, two patch pockets and detachable hood
- Cape back and underarm vents
- Bib overall pants come with fly front and adjustable suspenders
- Ankle and cuff take-up snaps
- Adjustable waist snaps
- Non-conductive fasteners
- Ultrasonically welded seams
- Compliant with CSA testing under CAN/CGSB standard 155.20 for flame resistance of textiles



Model No.	Size	Price /Each
SEH106	Small	26.50
SEH107	Medium	26.50
SEH108	Large	26.50
SEH109	X-Large	26.50
SEH110	2X-Large	26.50
SEH111	3X-Large	26.95
SEH112	4X-Large	27.25

## HI-VIS FR/PU SAFETY RAIN SUITS

- Stretchable FR treated PU/Polyester fabric lightweight and flexible in sub-zero conditions
- A light weight alternative to PVC with a high level of waterproofness (10000+)
- Good resistance to chemicals such as animal fats, fish oil, motor oil, and diesel fuel
- Meets testing method of CAN/CGSB-4.2 No.27.10 & ASTM D6413 Flame Resistance
- 2" 3M Scotchlite reflective material in 4" contrasting tape meets WCB/Worksafe/DOT configuration
- Resistant to motor oil, diesel, chemicals, animal fats and fish oils
- Micro welded seams
- ESR nylon snap closure systems
- Ideal for highway and road work, oil and gas, agriculture, fisheries and forestry
- Fully compliant with CSA Z96-15 Class 2 Level 2 and ANSI/ISEA 107-2015 Type R, Class 3, ASTM D6413 (FR)

### JACKETS

- Large detachable hood to cover hard hat
- Adjustable wrist cuffs
- Underarm vents for breathability
- Two durable integrated front pockets



### BIB PANTS

- Bib pants with adjustable waist panel and ESR suspenders
- Adjustable boot cuffs



Fluo Orange Model No.	Mfg. No.	Lime-Yellow Model No.	Mfg. No.	Size	Price /Each
<b>JACKETS</b>					
SDP054	6055FRJO-S	SDP068	6055FRJG-S	Small	131.00
SDP055	6055FRJO-M	SDP069	6055FRJG-M	Medium	131.00
SDP056	6055FRJO-L	SDP070	6055FRJG-L	Large	131.00
SDP057	6055FRJO-XL	SDP071	6055FRJG-XL	X-Large	131.00
SDP058	6055FRJO-2XL	SDP072	6055FRJG-2XL	2X-Large	131.00
SDP059	6055FRJO-3XL	SDP073	6055FRJG-3XL	3X-Large	131.00
<b>BIB PANTS</b>					
SDP061	6055FRPO-S	SDP075	6055FRPG-S	Small	93.70
SDP062	6055FRPO-M	SDP076	6055FRPG-M	Medium	93.70
SDP063	6055FRPO-L	SDP077	6055FRPG-L	Large	93.70
SDP064	6055FRPO-XL	SDP078	6055FRPG-XL	X-Large	93.70
SDP065	6055FRPO-2XL	SDP079	6055FRPG-2XL	2X-Large	93.70
SDP066	6055FRPO-3XL	SDP080	6055FRPG-3XL	3X-Large	93.70

# HIGH VISIBILITY CLOTHING



## 5-POINT TEAR-AWAY TRAFFIC SAFETY VESTS

- Lightweight and comfortable fluorescent orange sports mesh knit fabric provides daytime visibility
- 2" yellow reflective stripes
- Bright reflective stripes provide 360° nighttime visibility
- 5-point tear-away features on shoulders, sides and front for easy quick release



Model No.	Size	Price /Each
SEF093	Medium	10.45
SEF094	Large	10.45
SEF095	X-Large	10.45
SEF096	2X-Large	10.45
MEETS CSA STANDARD Z96-09, CLASS 2, LEVEL 2 REQUIREMENTS		
SEF097	Medium	19.50
SEF098	Large	19.50
SEF099	X-Large	19.50
SEF100	2X-Large	19.50



SEF093



SEF097

## CSA-COMPLIANT TRAFFIC SAFETY VESTS



- Lightweight and comfortable, fluorescent sport mesh knit fabric
- 360° horizontal stripe around torso, two vertical stripes on front and 'X' on back
- 4" reflective stripes offer maximum night-time visibility
- Front hook & loop closure permits optimal fitting
- Machine washable
- Material: Polyester
- Standard(s) Met: CSA Z96 Class 2 – Level 2



Model No.	Colour	Size	Price /Each
SGI273	Orange	Medium	10.95
SGI274	Orange	Large	10.95
SGI275	Orange	X-Large	10.95
SGI276	Orange	2X-Large	10.95
SGI277	High Visibility Yellow	Medium	10.95
SGI278	High Visibility Yellow	Large	10.95
SGI279	High Visibility Yellow	X-Large	10.95
SGI280	High Visibility Yellow	2X-Large	10.95

## FLAME-RESISTANT HIGH VISIBILITY SURVEYOR VEST



- Lightweight and comfortable, fluorescent FR-treated polyester mesh fabric provides daytime visibility and flame resistance
- 4" silver reflective stripes offer maximum night-time visibility
- 5-point tear-away features on shoulders, sides and front for easy quick release
- Safety D-ring access slot
- Three hook & loop sealed pockets and one open pocket
- Two radio loops
- Compliant with CSA testing under CAN/CGSB standard 4.2 No. 27.10 for flame resistance of textile fabrics
- Reflective Stripe Colour: Silver
- Material: Polyester
- Standard(s) Met: CSA Z96 Class 2 - Level 2



Model No.	Colour	Size	Price /Each
SGF136	High Visibility Orange	Medium	19.95
SGF137	High Visibility Orange	Large	19.95
SGF138	High Visibility Orange	X-Large	19.95
SGF139	High Visibility Orange	2X-Large	19.95
SGF140	High Visibility Lime-Yellow	Medium	19.95
SGF141	High Visibility Lime-Yellow	Large	19.95
SGF142	High Visibility Lime-Yellow	X-Large	19.95
SGF143	High Visibility Lime-Yellow	2X-Large	19.95

## CSA COMPLIANT HIGH VISIBILITY SURVEYOR VESTS



- Lightweight and comfortable fluorescent sports mesh knit fabric provides daytime visibility
- 5-point tear-away features on shoulders, sides and front for easy quick release
- Safety D-ring access slot
- Two top hook and loop sealed pockets and two bottom open pockets
- Two radio loops
- Machine washable
- Material: Polyester
- Meets CSA standard Z96-09, Class 2, Level 2 requirements



SEF101



SEK232

Model No.	Reflective Stripe Colour	Model No.	Reflective Stripe Colour	Size	Price /Each
SEF101	Yellow/Silver	SEK232	Orange/Silver	Medium	14.95
SEF102	Yellow/Silver	SEK233	Orange/Silver	Large	14.95
SEF103	Yellow/Silver	SEK234	Orange/Silver	X-Large	14.95
SEF104	Yellow/Silver	SEK235	Orange/Silver	2X-Large	14.95

## CSA-COMPLIANT HIGH-VISIBILITY SURVEYOR VEST



- Lightweight and comfortable fluorescent solid polyester provides daytime visibility
- 4" yellow/silver reflective stripes offer maximum nighttime visibility
- 5-point tear-away feature on shoulders, sides and front for easy quick release
- Safety D-ring access slot
- Two top hook and loop sealed pockets and two bottom open pockets
- Two radio loops
- Machine washable
- Includes clear plastic pocket for ID badges
- Colour: High Visibility Orange
- Reflective Stripe Colour: Yellow & Silver
- Material: Polyester
- Standard(s) Met: CSA Z96 Class 2 - Level 2



Model No.	Size	Price /Each
SGZ627	Medium	17.95
SGZ628	Large	17.95
SGZ629	X-Large	17.95
SGZ630	2X-Large	17.95



## DROP SHOULDER SAFETY TEAR-AWAY VEST

- Tricot polyester interlock
- ANSI/ISEA 107-2020 Class 2 Type P and R
- StarTech® reflective tape
- ID pocket
- 5 point tear-away
- 4 sealed pockets
- Radiophone clip strap
- D ring access slot
- Adjustable 1 size up at front
- Colour: High Visibility Orange
- Reflective Stripe Colour: Silver, Yellow
- Material: Polyester
- Standard(s) Met: CSA Z96 Class 2 - Level 2



Model No.	Mfg. No.	Size	Price /Each
SHA693	V102195A-S/M	Small, Medium	31.40
SHA694	V102195A-L/XL	Large, X-Large	31.40
SHA695	V102195A-2/3XL	2X-Large, 3X-Large	31.40
SHA696	V102195A-4/5XL	4X-Large, 5X-Large	31.40

## 1200D SURVEYOR'S VEST

- 1200 Denier oxford polyester PU reinforced durable material
- Startech reflective tape
- Tough binding on all edges
- Dual layer pocket on the front with pen slot and straps
- Large lower pockets with grommets and flaps
- Radiophone pocket with strap on chest
- Large cross back pocket with zipper closure
- One ruler pockets on the back
- Two large inner pockets with load bearing straps
- 13 pockets total
- Material: Polyester
- Standard(s) Met: CSA Z96 Class 2 - Level 2



Model No.	Mfg. No.	Colour	Reflective Stripe Colour	Size	Price /Each
SHC706	V1011150-3XL	High Visibility Orange	Yellow & Silver	3X-Large	84.40
SHC707	V1011150-4XL	High Visibility Orange	Yellow & Silver	4X-Large	84.40
SHC708	V1011150-5XL	High Visibility Orange	Yellow & Silver	5X-Large	84.40
SHC709	V1011160-S	High Visibility Lime-Yellow	Orange & Silver	Small	84.40
SHC710	V1011160-M	High Visibility Lime-Yellow	Orange & Silver	Medium	84.40
SHC711	V1011160-L	High Visibility Lime-Yellow	Orange & Silver	Large	84.40
SHC712	V1011160-XL	High Visibility Lime-Yellow	Orange & Silver	X-Large	84.40
SHC713	V1011160-2XL	High Visibility Lime-Yellow	Orange & Silver	2X-Large	84.40
SHC714	V1011160-3XL	High Visibility Lime-Yellow	Orange & Silver	3X-Large	84.40
SHC715	V1011160-4XL	High Visibility Lime-Yellow	Orange & Silver	4X-Large	84.40
SHC716	V1011160-5XL	High Visibility Lime-Yellow	Orange & Silver	5X-Large	84.40

## TRAFFIC HARNESSSES

- 1 1/2" reflective stripes
- Elasticized material permits optimal fit
- Four strap adjusters and front clip for maximum adjustability



SGZ622



SEF117

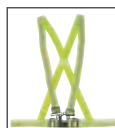

Lime-Yellow Model No.	Orange Model No.	Size	Price /Each
SEF117	SGZ622	Medium	10.95
SEF118	SGZ623	Large	10.95
SEF119	SGZ624	X-Large	10.95
SEF120	SGZ625	2X-Large	10.95
SEF121	SGZ626	3X-Large	10.95



## MESH-BACK ZIP-FRONT SURVEYOR'S VEST

- These mesh back surveyor's vests offer a perfect blend of durability and comfort and has all the pockets necessary to store essential tools and plans
- Made with a full mesh back panel for unsurpassed breathability and comfort
- Premium Startech® reflective tape provides maximum visibility in all work environments
- Oxford front panel is lightweight yet durable
- Includes convenient bottom pouch to store maps and plans
- 12 total pockets provide added versatility while keeping valuables and tools secure
- Full length zipper for quick and easy donning and doffing
- Includes ID pocket with transparent window
- Made with D-ring harness access on back
- Material: Polyester
- Standard(s) Met: CSA Z96 Class 2 - Level 2



Model No.	Mfg. No.	Colour	Reflective Stripe Colour	Size	Price /Each
SHC627	V1010260-S	High Visibility Lime-Yellow	Orange & Silver	Small	48.40
SHC628	V1010260-M	High Visibility Lime-Yellow	Orange & Silver	Medium	48.40
SHC629	V1010260-L	High Visibility Lime-Yellow	Orange & Silver	Large	48.40
SHC630	V1010260-XL	High Visibility Lime-Yellow	Orange & Silver	X-Large	48.40
SHC631	V1010260-2XL	High Visibility Lime-Yellow	Orange & Silver	2X-Large	48.40
SHC632	V1010260-3XL	High Visibility Lime-Yellow	Orange & Silver	3X-Large	48.40
SHC633	V1010260-4XL	High Visibility Lime-Yellow	Orange & Silver	4X-Large	48.40
SHC634	V1010270-S	Black	Yellow & Silver	Small	48.40
SHC635	V1010270-M	Black	Yellow & Silver	Medium	48.40
SHC636	V1010270-L	Black	Yellow & Silver	Large	48.40
SHC637	V1010270-XL	Black	Yellow & Silver	X-Large	48.40
SHC638	V1010270-2XL	Black	Yellow & Silver	2X-Large	48.40
SHC639	V1010270-3XL	Black	Yellow & Silver	3X-Large	48.40
SHC640	V1010270-4XL	Black	Yellow & Silver	4X-Large	48.40

## ZIP-FRONT BI-COLOUR SAFETY VEST

- Premium material is durable, lightweight, and provides all-day working comfort
- Exclusive Startech® reflective tape provides maximum visibility even in low lit working conditions
- Full front zipper closure provides a secure fit and easy on/off
- Generous number of pockets provide maximum versatility and function
- Ideal for road work, construction, traffic control, industrial settings, and more
- Material: Polyester
- Standard(s) Met: CSA Z96 Class 2 - Level 2



Model No.	Mfg. No.	Colour	Reflective Stripe Colour	Size	Price /Each
SHC842	V1024950-S/M	High Visibility Orange	Yellow & Silver	Small, Medium	26.80
SHC843	V1024950-L/XL	High Visibility Orange	Yellow & Silver	Large, X-Large	26.80
SHC844	V1024950-2/3XL	High Visibility Orange	Yellow & Silver	2X-Large, 3X-Large	26.80
SHC845	V1024950-4/5XL	High Visibility Orange	Yellow & Silver	4X-Large, 5X-Large	26.80

## ARM & LEG BANDS

- 2" lime-yellow/silver reflective bands
- Hook and loop closure permits optimal fit
- Available in various lengths
- Sold individually



Model No.	Length"	Price /Each
SEF122	10	3.75
SEF123	12	3.75
SEF124	13 1/2	3.75
SEF125	15	3.75
SEF126	17	3.75
SEF127	19	3.75



# HIGH VISIBILITY CLOTHING

## 400 HV HIGH VISIBILITY COVERALLS WITH COLLAR

- Durability & breathability of Tyvek® in a high-visibility garment that is permeable to both air and water vapor, yet repels water-based liquids and aerosols
- Bright fluorescent orange colour background material combined with silver grey retroreflective material make the garment highly visible during the day and at night
- Antistatic treatment EN-1149-5 on inside
- Chemical protective clothing, Category III, Type 5-B and 6-B
- Stitched external seams, elasticated wrists and ankles as well as glued-in waist elastic
- Very low inward leakage thanks to optimized design
- Tyvek® auto-lock zipper and zipper flap for increased protection
- Dolman sleeve design for greater range of motion and comfort
- Gusset crotch for greater freedom of movement

«DUPONT»  
**Tyvek.**



Model No.	Size	Price /Each
SGR810	Small	33.50
SGR811	Medium	33.50
SGR812	Large	33.50
SGR813	X-Large	33.50
SGR814	2X-Large	35.50
SGR815	3X-Large	37.60
SGR816	4X-Large	40.60

## HI-VIZ ORANGE KNIT HAT WITH REFLECTIVE STRIPE

- Silver reflective stripe woven into the hat
- One size fits all
- Material: Acrylic



**ZENITH**  
Safety Products

SGJ105

SGI135

Model No.	Colour	Price /Each
SGI135	High Visibility Orange	9.29
SGJ105	Black	9.29

## N-FERNO® 6821 FLEECE BALACLAVA

- Polyester stretch fleece keeps head and neck warm
- Long length
- Reflective piping for higher visibility
- Fits under helmet or hard hat without feeling too bulky
- Material: Fleece



Model No.	Mfg. No.	Colour	Price /Each
SGC107	16829	High-Visibility Lime Green	12.60

## PREMIUM QUALITY HIGH-VIZ GRAIN COWHIDE FITTERS GLOVES

- Good abrasion resistance
- Full leather-tipped fingers and knuckle strap
- Fluorescent back and two gray reflective stripes offer maximum visibility
- Rubberized safety cuff

**Applications:** Material handling, fabrication, metal handling and construction



**ZENITH**  
Safety Products

Case Qty: 120

Priced per Pair

Model No.	Size	Description	Price /Each
SEK239	Large	High Visibility Green, Unlined	8.50
SEK242	Large	High Visibility Orange, Cotton lined	8.50

## PREMIUM QUALITY HI-VIZ GRAIN COWHIDE FITTERS GLOVES

- Premium quality
- 100-g Thinsulate™ liner provides superior warmth
- Superior abrasion resistance
- Excellent comfort and durability
- Resists oil and water well
- Full leather tipped fingers and knuckle strap
- Fluorescent yellow back and two grey reflective stripes offer maximum visibility
- Rubberized safety cuff



**ZENITH**  
Safety Products

Case Qty: 72

Priced per Pair

Model No.	Size	Colour	Price /Each
SED428	Large	Fluorescent Yellow	12.20
SEK237	Large	Fluorescent Orange	12.20

# HIGH VISIBILITY CLOTHING

## DROP-SHOULDER TEAR-AWAY SURVEYOR'S VESTS

- 7.5 oz. (260 GSM) poly/cotton
- Cooling mesh panels across the shoulders and under the arms
- StarTech® reflective tape
- 5 point tear-away, brass snap front, chest pocket with reflective hook and loop closure on the left, chest pocket on the right, mid pocket with 2 pen slots on the left, 2 lower pockets with flaps, 2 radiophone clip straps, and 2 inside pockets
- Extra-long back for additional coverage
- D ring access slot
- Standard(s) Met: CSA Z96 Class 2 - Level 2

SHC694



SHC687



Model No.	Mfg. No.	Colour	Reflective Stripe Colour	Size	Material	Price /Each
SHC687	V1010850-S	High Visibility Orange	Yellow & Silver	Small	Poly-Cotton	70.60
SHC688	V1010850-M	High Visibility Orange	Yellow & Silver	Medium	Poly-Cotton	70.60
SHC689	V1010850-L	High Visibility Orange	Yellow & Silver	Large	Poly-Cotton	70.60
SHC690	V1010850-XL	High Visibility Orange	Yellow & Silver	X-Large	Poly-Cotton	70.60
SHC691	V1010850-2XL	High Visibility Orange	Yellow & Silver	2X-Large	Poly-Cotton	70.60
SHC692	V1010850-3XL	High Visibility Orange	Yellow & Silver	3X-Large	Poly-Cotton	70.60
SHC693	V1010850-4XL	High Visibility Orange	Yellow & Silver	4X-Large	Poly-Cotton	70.60
SHC694	V1010860-S	High Visibility Lime-Yellow	Orange & Silver	Small	Poly-Cotton	70.60
SHC695	V1010860-M	High Visibility Lime-Yellow	Orange & Silver	Medium	Poly-Cotton	70.60
SHC696	V1010860-L	High Visibility Lime-Yellow	Orange & Silver	Large	Poly-Cotton	70.60
SHC697	V1010860-XL	High Visibility Lime-Yellow	Orange & Silver	X-Large	Poly-Cotton	70.60
SHC698	V1010860-2XL	High Visibility Lime-Yellow	Orange & Silver	2X-Large	Poly-Cotton	70.60
SHC699	V1010860-3XL	High Visibility Lime-Yellow	Orange & Silver	3X-Large	Poly-Cotton	70.60
SHC700	V1010860-4XL	High Visibility Lime-Yellow	Orange & Silver	4X-Large	Poly-Cotton	70.60

## WOMEN'S SAFETY VESTS

- Specially tailored with the woman worker in mind
- Tricot polyester material delivers a soft and breathable garment
- Premium Startech® reflective tape provides maximum visibility
- Made with 9 total pockets including compartments for ID and mobile phone
- Full front zipper keeps vest secure while on the job
- Comes complete with a radiophone clip strap
- Ideal for school crossing guards, airport baggage handlers, and much more
- Standard(s) Met: CSA Z96 Class 1 - Level 2

SHC782



SHC775



Model No.	Mfg. No.	Colour	Reflective Stripe Colour	Size	Material	Price /Each
SHC768	V1021850-XS	High Visibility Orange	Yellow & Silver	X-Small	Polyester	30.80
SHC769	V1021850-S	High Visibility Orange	Yellow & Silver	Small	Polyester	30.80
SHC770	V1021850-M	High Visibility Orange	Yellow & Silver	Medium	Polyester	30.80
SHC771	V1021850-L	High Visibility Orange	Yellow & Silver	Large	Polyester	30.80
SHC772	V1021850-XL	High Visibility Orange	Yellow & Silver	X-Large	Polyester	30.80
SHC773	V1021850-2XL	High Visibility Orange	Yellow & Silver	2X-Large	Polyester	30.80
SHC774	V1021850-3XL	High Visibility Orange	Yellow & Silver	3X-Large	Polyester	30.80
SHC775	V1021860-XS	High Visibility Lime-Yellow	Orange & Silver	X-Small	Polyester	30.80
SHC776	V1021860-S	High Visibility Lime-Yellow	Orange & Silver	Small	Polyester	30.80
SHC777	V1021860-M	High Visibility Lime-Yellow	Orange & Silver	Medium	Polyester	30.80
SHC778	V1021860-L	High Visibility Lime-Yellow	Orange & Silver	Large	Polyester	30.80
SHC779	V1021860-XL	High Visibility Lime-Yellow	Orange & Silver	X-Large	Polyester	30.80
SHC780	V1021860-2XL	High Visibility Lime-Yellow	Orange & Silver	2X-Large	Polyester	30.80
SHC781	V1021860-3XL	High Visibility Lime-Yellow	Orange & Silver	3X-Large	Polyester	30.80
SHC782	V1021870-XS	Black	Yellow & Silver	X-Small	Polyester	30.80
SHC783	V1021870-S	Black	Yellow & Silver	Small	Polyester	30.80
SHC784	V1021870-M	Black	Yellow & Silver	Medium	Polyester	30.80
SHC785	V1021870-L	Black	Yellow & Silver	Large	Polyester	30.80
SHC786	V1021870-XL	Black	Yellow & Silver	X-Large	Polyester	30.80
SHC787	V1021870-2XL	Black	Yellow & Silver	2X-Large	Polyester	30.80
SHC788	V1021870-3XL	Black	Yellow & Silver	3X-Large	Polyester	30.80

## UNLINED SAFETY COVERALLS

- Made from 65% polyester and 35% cotton twill
- 3M™ Scotchlite™ Reflective Material with 4" contrast backing
- Upper chest pockets with hook and loop closure flaps
- Storm flap over center front 2-way Vislon zipper
- Adjustable snap cuffs and leg openings
- Side openings at hip for easy access to underlayers
- Action back
- Back elastic waist
- Colour: High Visibility Orange
- Reflective Colour: Silver, Yellow
- Standard(s) Met: CSA Z96 Class 3 - Level 2



Model No.	Size	Price /Each
SHF985	Small	72.50
SHF986	Medium	72.50
SHF987	Large	72.50
SHF988	X-Large	72.50
SHF989	2X-Large	72.50



# HIGH VISIBILITY CLOTHING

## BIRD'S-EYE SAFETY POLO SHIRT

- Bird's-Eye material is soft, breathable, and wicks away moisture to keep you dry and comfortable
- Exclusive StarTech® reflective tape enhances visibility even in low light conditions
- Features a front chest pocket with a hook and loop closure
- Includes radiophone clip strap
- Rib polo collar with contrast stripes
- UPF 50+ UV protection
- Material: Polyester
- Standard(s) Met: CSA Z96 Class 2 - Level 2
- ANSI Certification: ANSI 107-2020 Class 2 Type P & R



SHC956

Model No.	Mfg. No.	Background Colour	Reflective Stripe Colour	Size	Price /Each
SHC956	V1051350-S	High Visibility Orange	Silver, Yellow	Small	41.90
SHC957	V1051350-M	High Visibility Orange	Silver, Yellow	Medium	41.90
SHC958	V1051350-L	High Visibility Orange	Silver, Yellow	Large	41.90
SHC959	V1051350-XL	High Visibility Orange	Silver, Yellow	X-Large	41.90
SHC960	V1051350-2XL	High Visibility Orange	Silver, Yellow	2X-Large	41.90
SHC961	V1051350-3XL	High Visibility Orange	Silver, Yellow	3X-Large	41.90
SHC962	V1051350-4XL	High Visibility Orange	Silver, Yellow	4X-Large	41.90
SHC963	V1051350-5XL	High Visibility Orange	Silver, Yellow	5X-Large	41.90
SHC964	V1051360-XS	High Visibility Lime-Yellow	Silver, Orange	X-Small	41.90
SHC965	V1051360-S	High Visibility Lime-Yellow	Silver, Orange	Small	41.90
SHC966	V1051360-M	High Visibility Lime-Yellow	Silver, Orange	Medium	41.90
SHC967	V1051360-L	High Visibility Lime-Yellow	Silver, Orange	Large	41.90
SHC968	V1051360-XL	High Visibility Lime-Yellow	Silver, Orange	X-Large	41.90
SHC969	V1051360-2XL	High Visibility Lime-Yellow	Silver, Orange	2X-Large	41.90
SHC970	V1051360-3XL	High Visibility Lime-Yellow	Silver, Orange	3X-Large	41.90
SHC971	V1051360-4XL	High Visibility Lime-Yellow	Silver, Orange	4X-Large	41.90
SHC972	V1051360-5XL	High Visibility Lime-Yellow	Silver, Orange	5X-Large	41.90

## BIRD'S-EYE SAFETY SHIRT

- Bird's-Eye material is soft, breathable, and wicks away moisture to keep you dry and comfortable
- Exclusive StarTech® reflective tape enhances visibility even in low light conditions
- Features a front chest pocket with a hook and loop closure
- Includes radiophone clip strap
- Crew neck



SHC920

Model No.	Mfg. No.	Background Colour	Reflective Stripe Colour	Size	Price /Each
CSA Z96 CLASS 2 - LEVEL 2, ANSI 107-2020 CLASS 2 TYPE P & R					
SHC920	V1051150-XS	High Visibility Orange	Silver, Yellow	X-Small	23.30
SHC921	V1051150-S	High Visibility Orange	Silver, Yellow	Small	23.30
SHC922	V1051150-M	High Visibility Orange	Silver, Yellow	Medium	23.30
SHC923	V1051150-L	High Visibility Orange	Silver, Yellow	Large	23.30
SHC924	V1051150-XL	High Visibility Orange	Silver, Yellow	X-Large	23.30
SHC925	V1051150-2XL	High Visibility Orange	Silver, Yellow	2X-Large	23.30
SHC926	V1051150-3XL	High Visibility Orange	Silver, Yellow	3X-Large	23.30
SHC927	V1051150-4XL	High Visibility Orange	Silver, Yellow	4X-Large	23.30
SHC928	V1051150-5XL	High Visibility Orange	Silver, Yellow	5X-Large	23.30
SHC929	V1051160-XS	High Visibility Lime-Yellow	Silver, Orange	X-Small	23.30
SHC930	V1051160-S	High Visibility Lime-Yellow	Silver, Orange	Small	23.30
SHC931	V1051160-M	High Visibility Lime-Yellow	Silver, Orange	Medium	23.30
SHC932	V1051160-L	High Visibility Lime-Yellow	Silver, Orange	Large	23.30
SHC933	V1051160-XL	High Visibility Lime-Yellow	Silver, Orange	X-Large	23.30
SHC934	V1051160-2XL	High Visibility Lime-Yellow	Silver, Orange	2X-Large	23.30
SHC935	V1051160-3XL	High Visibility Lime-Yellow	Silver, Orange	3X-Large	23.30
SHC936	V1051160-4XL	High Visibility Lime-Yellow	Silver, Orange	4X-Large	23.30
SHC937	V1051160-5XL	High Visibility Lime-Yellow	Silver, Orange	5X-Large	23.30

### CSA Z96 CLASS 1 - LEVEL 2, ANSI 107-2020 CLASS 1 TYPE O

SHC938	V1051170-XS	Black	Silver, Yellow	X-Small	23.30
SHC939	V1051170-S	Black	Silver, Yellow	Small	23.30
SHC940	V1051170-M	Black	Silver, Yellow	Medium	23.30
SHC941	V1051170-L	Black	Silver, Yellow	Large	23.30
SHC942	V1051170-XL	Black	Silver, Yellow	X-Large	23.30
SHC943	V1051170-2XL	Black	Silver, Yellow	2X-Large	23.30
SHC944	V1051170-3XL	Black	Silver, Yellow	3X-Large	23.30
SHC945	V1051170-4XL	Black	Silver, Yellow	4X-Large	23.30
SHC946	V1051170-5XL	Black	Silver, Yellow	5X-Large	23.30
SHC947	V1051180-XS	Navy Blue	Silver, Yellow	X-Small	23.30
SHC948	V1051180-S	Navy Blue	Silver, Yellow	Small	23.30
SHC949	V1051180-M	Navy Blue	Silver, Yellow	Medium	23.30
SHC950	V1051180-L	Navy Blue	Silver, Yellow	Large	23.30
SHC951	V1051180-XL	Navy Blue	Silver, Yellow	X-Large	23.30
SHC952	V1051180-2XL	Navy Blue	Silver, Yellow	2X-Large	23.30
SHC953	V1051180-3XL	Navy Blue	Silver, Yellow	3X-Large	23.30
SHC954	V1051180-4XL	Navy Blue	Silver, Yellow	4X-Large	23.30
SHC955	V1051180-5XL	Navy Blue	Silver, Yellow	5X-Large	23.30

## PREMIUM POLYESTER T-SHIRTS

- Moisture wicking, lightweight, soft and breathable fabric
- Fluorescent lime-green 100% polyester "bird's eye" mesh material
- 3" fluorescent orange/silver dual reflective stripes
- Upper left breast pocket with hook and loop closure
- Two radio loops
- Machine washable
- Meets CSA standard Z96-09, Class 2, Level 2 requirements



Model No.	Lime-Yellow	Orange	Size	Price /Each
SEF109	SEL243		Medium	19.50
SEF110	SEL244		Large	19.50
SEF111	SEL245		X-Large	19.50
SEF112	SEL246		2X-Large	19.50

## LONG-SLEEVED SAFETY SHIRT

- 100% cotton jersey knit
- Crew neck
- StarTech® reflective tape
- Radiophone clip strap
- Chest pocket with hook and loop closure
- Material: Cotton
- Standard(s) Met: CSA Z96 Class 1 - Level 2
- ANSI Certification: ANSI 107-2020 Class 1 Type O



SHC897

Model No.	Mfg. No.	Background Colour	Reflective Stripe Colour	Size	Price /Each
SHC897	V1050850-S	High Visibility Orange	Silver, Yellow	Small	57.60
SHC898	V1050850-M	High Visibility Orange	Silver, Yellow	Medium	57.60
SHC899	V1050850-L	High Visibility Orange	Silver, Yellow	Large	57.60
SHC900	V1050850-XL	High Visibility Orange	Silver, Yellow	X-Large	57.60
SHC901	V1050850-2XL	High Visibility Orange	Silver, Yellow	2X-Large	57.60
SHC902	V1050850-3XL	High Visibility Orange	Silver, Yellow	3X-Large	57.60
SHC903	V1050850-4XL	High Visibility Orange	Silver, Yellow	4X-Large	57.60
SHC904	V1050860-S	High Visibility Lime-Yellow	Silver, Orange	Small	57.60
SHC905	V1050860-M	High Visibility Lime-Yellow	Silver, Orange	Medium	57.60
SHC906	V1050860-L	High Visibility Lime-Yellow	Silver, Orange	Large	57.60
SHC907	V1050860-XL	High Visibility Lime-Yellow	Silver, Orange	X-Large	57.60
SHC908	V1050860-2XL	High Visibility Lime-Yellow	Silver, Orange	2X-Large	57.60
SHC909	V1050860-3XL	High Visibility Lime-Yellow	Silver, Orange	3X-Large	57.60
SHC910	V1050860-4XL	High Visibility Lime-Yellow	Silver, Orange	4X-Large	57.60
SHC911	V1050870-XS	Black	Silver, Yellow	X-Small	57.60
SHC912	V1050870-S	Black	Silver, Yellow	Small	57.60
SHC913	V1050870-M	Black	Silver, Yellow	Medium	57.60
SHC914	V1050870-L	Black	Silver, Yellow	Large	57.60
SHC915	V1050870-XL	Black	Silver, Yellow	X-Large	57.60
SHC916	V1050870-2XL	Black	Silver, Yellow	2X-Large	57.60
SHC917	V1050870-3XL	Black	Silver, Yellow	3X-Large	57.60
SHC918	V1050870-4XL	Black	Silver, Yellow	4X-Large	57.60
SHC919	V1050870-5XL	Black	Silver, Yellow	5X-Large	57.60

## MICRO MESH TRAFFIC T-SHIRT

- 3.7 oz. (125 GSM) quick-dry micro mesh
- StarTech® reflective tape
- Radiophone clip strap
- Chest pocket with hook and loop closure
- Standard(s) Met: CSA Z96 Class 2 - Level 2
- ANSI Certification: ANSI 107-2020 Class 2 Type P & R



SHC888

Model No.	Mfg. No.	Background Colour	Reflective Stripe Colour	Size	Price /Each
SHC888	V1050650-XS	High Visibility Orange	Silver, Yellow	X-Small	31.70
SHC889	V1050650-S	High Visibility Orange	Silver, Yellow	Small	31.70
SHC890	V1050650-M	High Visibility Orange	Silver, Yellow	Medium	31.70
SHC891	V1050650-L	High Visibility Orange	Silver, Yellow	Large	31.70
SHC892	V1050650-XL	High Visibility Orange	Silver, Yellow	X-Large	31.70
SHC893	V1050650-2XL	High Visibility Orange	Silver, Yellow	2X-Large	31.70
SHC894	V1050650-3XL	High Visibility Orange	Silver, Yellow	3X-Large	31.70
SHC895	V1050650-4XL	High Visibility Orange	Silver, Yellow	4X-Large	31.70
SHC896	V1050650-5XL	High Visibility Orange	Silver, Yellow	5X-Large	31.70

## ULTRA-COOL LONG-SLEEVED SAFETY SHIRT

- Lightweight, ultra-cool, hi-viz work shirt
- 100% cotton twill, 5.9 oz. (200 GSM)
- Double-stitched StarTech® reflective tape
- 2 chest pockets (1 with flap and pen slot)
- Button-down collar
- Material: Cotton
- Standard(s) Met: CSA Z96 Class 2 - Level 2



Model No.	Mfg. No.	Background Colour	Reflective Stripe Colour	Size	Price /Each
SHD853	V2120510-S	High Visibility Orange	Silver, Yellow	Small	73.20
SHD854	V2120510-M	High Visibility Orange	Silver, Yellow	Medium	73.20
SHD855	V2120510-L	High Visibility Orange	Silver, Yellow	Large	73.20
SHD856	V2120510-XL	High Visibility Orange	Silver, Yellow	X-Large	73.20
SHD857	V2120510-2XL	High Visibility Orange	Silver, Yellow	2X-Large	73.20
SHD858	V2120510-3XL	High Visibility Orange	Silver, Yellow	3X-Large	73.20
SHD859	V2120510-4XL	High Visibility Orange	Silver, Yellow	4X-Large	73.20

## THE ROCK 3-IN-1 PARKA

- 100% waterproof 300D oxford polyester with PU coating
- CSA Z96-22 Class 2 Level 2 (becomes Class 3 when worn with hi-viz pant featuring reflective leg bands) and ANSI/ISEA 107-2020 Class 3 Type P and R
- StarTech® reflective tape
- Superior tear- and abrasion-resistant fabric
- Double stitched, taped and heat sealed seams
- Outer jacket: liberal fit and full back vent for working comfort, fully taffeta lined, 2 lower flap pockets, full front zipper plus inner zipper for fleece lining, snap-off 3-piece hood folds into collar, adjustable cuffs
- Zip-out inner fleece jacket: warm, 8.2 oz. (280 GSM) black fleece liner, 2 lower pockets slash pockets, reversible head main zipper, loops at neck and wrists to attach to outer jacket
- Material: Polyester
- Standard(s) Met: CSA Z96 Class 2 - Level 2, ANSI/ISEA 107 Class 3



Model No.	Mfg. No.	Colour	Reflective Colour	Size	Price /Each
SHD248	V1083150-XS	High Visibility Orange	Silver, Yellow	X-Small	170.00
SHD249	V1083150-S	High Visibility Orange	Silver, Yellow	Small	170.00
SHD250	V1083150-M	High Visibility Orange	Silver, Yellow	Medium	170.00
SHD251	V1083150-L	High Visibility Orange	Silver, Yellow	Large	170.00
SHD252	V1083150-XL	High Visibility Orange	Silver, Yellow	X-Large	170.00
SHD253	V1083150-2XL	High Visibility Orange	Silver, Yellow	2X-Large	170.00
SHD254	V1083150-3XL	High Visibility Orange	Silver, Yellow	3X-Large	170.00
SHD255	V1083150-4XL	High Visibility Orange	Silver, Yellow	4X-Large	170.00
SHD256	V1083150-5XL	High Visibility Orange	Silver, Yellow	5X-Large	170.00
SHD257	V1083160-XS	High Visibility Lime-Yellow	Silver, Orange	X-Small	170.00
SHD258	V1083160-S	High Visibility Lime-Yellow	Silver, Orange	Small	170.00
SHD259	V1083160-M	High Visibility Lime-Yellow	Silver, Orange	Medium	170.00
SHD260	V1083160-L	High Visibility Lime-Yellow	Silver, Orange	Large	170.00
SHD261	V1083160-XL	High Visibility Lime-Yellow	Silver, Orange	X-Large	170.00
SHD262	V1083160-2XL	High Visibility Lime-Yellow	Silver, Orange	2X-Large	170.00
SHD263	V1083160-3XL	High Visibility Lime-Yellow	Silver, Orange	3X-Large	170.00
SHD264	V1083160-4XL	High Visibility Lime-Yellow	Silver, Orange	4X-Large	170.00
SHD265	V1083160-5XL	High Visibility Lime-Yellow	Silver, Orange	5X-Large	170.00

## HARDHAT FOLDABLE SUNSHADE

- Lightweight polyester tricot
- Foldable brim for easy storage
- Large round brim and cape for 360° sun protection
- Reflective tape enhances visibility
- Fits all hard hat brim styles
- Colour: Yellow

Model No. SHD770  
Mfg. No. V2051360-O/S  
Price/Each \$12.60



## ZIP STYLE HOODIE

- 7 oz. (240 GSM) micro fleece
- 4-way comfort stretch
- StarTech® reflective tape
- Full front zipper
- Detachable drawstring hood
- Elastic cuffs and hem
- 2 front slash pockets
- 2 radiophone clip straps
- Material: Fleece
- Standard(s) Met: CSA Z96 Class 2 - Level 2
- Additional Certification(s): ANSI/ISEA 107-2020 Class 3 Type P & R



Model No.	Mfg. No.	Background Colour	Reflective Stripe Colour	Size	Price /Each
SHD050	V1060550-S	High Visibility Orange	Silver, Yellow	Small	76.10
SHD051	V1060550-M	High Visibility Orange	Silver, Yellow	Medium	76.10
SHD052	V1060550-L	High Visibility Orange	Silver, Yellow	Large	76.10
SHD053	V1060550-XL	High Visibility Orange	Silver, Yellow	X-Large	76.10
SHD054	V1060550-2XL	High Visibility Orange	Silver, Yellow	2X-Large	76.10
SHD055	V1060550-3XL	High Visibility Orange	Silver, Yellow	3X-Large	76.10
SHD056	V1060550-4XL	High Visibility Orange	Silver, Yellow	4X-Large	76.10
SHD057	V1060550-5XL	High Visibility Orange	Silver, Yellow	5X-Large	76.10
SHD058	V1060560-XS	High Visibility Lime-Yellow	Silver, Orange	X-Small	76.10
SHD059	V1060560-S	High Visibility Lime-Yellow	Silver, Orange	Small	76.10
SHD060	V1060560-M	High Visibility Lime-Yellow	Silver, Orange	Medium	76.10
SHD061	V1060560-L	High Visibility Lime-Yellow	Silver, Orange	Large	76.10
SHD062	V1060560-XL	High Visibility Lime-Yellow	Silver, Orange	X-Large	76.10
SHD063	V1060560-2XL	High Visibility Lime-Yellow	Silver, Orange	2X-Large	76.10
SHD064	V1060560-3XL	High Visibility Lime-Yellow	Silver, Orange	3X-Large	76.10
SHD065	V1060560-4XL	High Visibility Lime-Yellow	Silver, Orange	4X-Large	76.10
SHD066	V1060560-5XL	High Visibility Lime-Yellow	Silver, Orange	5X-Large	76.10
SHD067	V1060570-S	Black	Silver, Yellow	Small	76.10
SHD068	V1060570-M	Black	Silver, Yellow	Medium	76.10
SHD069	V1060570-L	Black	Silver, Yellow	Large	76.10
SHD070	V1060570-XL	Black	Silver, Yellow	X-Large	76.10
SHD071	V1060570-2XL	Black	Silver, Yellow	2X-Large	76.10
SHD072	V1060570-3XL	Black	Silver, Yellow	3X-Large	76.10
SHD073	V1060570-4XL	Black	Silver, Yellow	4X-Large	76.10
SHD074	V1060570-5XL	Black	Silver, Yellow	5X-Large	76.10

## WATERPROOF WINTER QUILTED SAFETY BOMBER JACKET

- 300 denier PU coated oxford polyester
- CSA Z96-22 Class 2 Level 2 (becomes Class 3 when worn with hi-viz pant featuring reflective leg bands)
- Exclusive StarTech® reflective tape provides maximum visibility and increased safety
- 100% waterproof and windproof
- 5.9 oz. (200 GSM) poly filling
- Taped and heat sealed seams
- Cell/radiophone pocket on left chest, inside storage pocket and pouch pocket, and 2 large front pockets
- Full front zipper with snap placket
- Embroidery access zipper
- Adjustable detachable hood folds into collar
- Knitted storm cuffs
- Zip-to-top fleece-lined collar
- Colour: High Visibility Orange
- Reflective Colour: Silver, Yellow
- Size: Small



Model No.	Mfg. No.	Colour	Reflective Colour	Size	Price /Each
SHD447	V1150250-S	High Visibility Orange	Silver, Yellow	Small	107.00
SHD448	V1150250-M	High Visibility Orange	Silver, Yellow	Medium	107.00
SHD449	V1150250-L	High Visibility Orange	Silver, Yellow	Large	107.00
SHD450	V1150250-XL	High Visibility Orange	Silver, Yellow	X-Large	107.00
SHD451	V1150250-2XL	High Visibility Orange	Silver, Yellow	2X-Large	107.00
SHD452	V1150250-3XL	High Visibility Orange	Silver, Yellow	3X-Large	107.00
SHD453	V1150250-4XL	High Visibility Orange	Silver, Yellow	4X-Large	107.00
SHD454	V1150250-5XL	High Visibility Orange	Silver, Yellow	5X-Large	107.00
SHD455	V1150260-S	High Visibility Lime-Yellow	Silver, Orange	Small	107.00
SHD456	V1150260-M	High Visibility Lime-Yellow	Silver, Orange	Medium	107.00
SHD457	V1150260-L	High Visibility Lime-Yellow	Silver, Orange	Large	107.00
SHD458	V1150260-XL	High Visibility Lime-Yellow	Silver, Orange	X-Large	107.00
SHD459	V1150260-2XL	High Visibility Lime-Yellow	Silver, Orange	2X-Large	107.00
SHD460	V1150260-3XL	High Visibility Lime-Yellow	Silver, Orange	3X-Large	107.00
SHD461	V1150260-4XL	High Visibility Lime-Yellow	Silver, Orange	4X-Large	107.00
SHD462	V1150260-5XL	High Visibility Lime-Yellow	Silver, Orange	5X-Large	107.00



## WINTER LINERS

### FLAME RESISTANT OUTER SHELL

Winter liners give you added protection in cold conditions or on windy days. Can be worn with caps, hats, welding helmets, hard hats or alone. One size fits all. Flame resistant outer shell.



SGU851

### SEVERE COLD

Twill outer layer, sheep thermal lined and full neck flap for severe cold.  
**Model No. SGU851**  
**Price/Each \$17.05**



SGU852

### MODERATE COLD

Twill outer layer and polyfiber/cotton lined for moderate to severe cold.  
**Model No. SGU852**  
**Price/Each \$11.75**



SAJ553

### MILD COLD

Single twill layer with napped inside for mild cold.  
**Model No. SAJ553**  
**Price/Each \$8.45**



## FLEECE BALACLAVA

- Can be used under hardhats
- Protects the head, face & neck from the harsh elements of winter
- Versatile; can be worn as a balaclava, neck warmer or as a dust mask
- Machine wash & air dry
- Size: One Size



Model No.	Color	Price/Each
SGJ655	Black	7.35

## 6810/6815 STRETCH CAPS

- 100% polyester knit
- Keeps ears and head protected from wind and cool conditions
- One size



Model No.	Mfg. No.	Description	Price/Each
SEE076	16810	Half Cap Style	11.30
SEE077	16815	Full Face Style	17.10

## WINTER LINERS

- Inner pockets at ears can hold warming packs for extra warmth
- Hook and loop straps for easy hard hat installation
- One size



Model No.	Mfg. No.	Style No.	Layers	Lining	Length	Price/Each
SEE069	16850	6850	2	Fleece	Chin	10.90
SEE070	16852	6852	2	Fleece	Shoulder	16.10
SEE072	16877	6877	3	Fleece	Shoulder	35.10
SEE066	16867	6867	3	Fleece	Shoulder	16.00
SEE068	16952	6952	3	Sherpa Fleece	Shoulder	18.40



## N-FERNO 6955 INSULATED BALACLAVA FACE MASK

- Three-layer thermal protection for full face, head and neck warmth in extreme cold
- Polartec® Power Grid™ lining enhances warming while remaining lightweight and breathable; wicks moisture for dry and warm all-day wear
- Polyester-spandex exterior comfortably stretches to fit a variety of head sizes
- Insulated mid-layer front panel for additional warmth where you need it most
- Ribbed front panel's lofted fit creates gap between material and mouth for easy breathing and talking
- Hinged design - can be worn in 3 different ways (open face balaclava, neck gaiter, or full face mask)
- Angled bottom for no-bulk layering
- Reflective accents keep workers seen and safe
- One size fits most
- Machine washable
- Material: Fleece, Polyester, Spandex



Model No.	Mfg. No.	Color	Price/Each
SHB322	16955	Black	67.50

## N-FERNO® 6823 WIND-PROOF HINGED BALACLAVA

- Fleece with wind-protectant fabric at most vulnerable places protects against a variety of elements
- Unique hinged design
- 3-panel construction with flat lock stitching for a comfortable "made just for you" fit
- Reflective accents help keep workers safe and seen
- Long length
- Size: One Size



Model No.	Mfg. No.	Color	Price/Each
SEL893	16823	Black	31.20



## BOSS® THERM™ BASE LAYER HEATED VEST

- Designed to be worn as a base layer over a shirt, or any thermal garment
- Lightweight, active fit one size fits all includes durable two-way locking hook and loop straps
- Heating elements located on the chest and back, warming a large surface area to promote blood circulation, relief from muscle pain, enhance metabolism and improve immunity
- Low, Medium, High temperature ranges
- Quick rechargeable 5V/2A power bank provides up to 7 hours of heat on the low setting with proper layering of garments
- Machine washable; Heating elements are designed to endure 50+ washing cycles
- Includes battery operated remote control and initial battery
- Additional batteries available: 399-HVBAT
- Replacement remote: 399-HVRE
- Size: One-Size
- Colour: Black
- Men's/Women's: Men's



SHA877



SHA658



Model No.	Mfg. No.	Price/Each
SHA658	PC300HV100U	205.00
<b>REPLACEMENT BATTERY</b>		
SHA877	PC399HVBAT	41.90

## TEMPEST TRI-ZONE OUTERWEAR

- High-tech Polyester/PVC shell and Taffeta/mesh lining

### JACKETS

- Adjustable hook and loop wrists
- Safety reflective piping front and back
- 4 large pockets, 1 utility sleeve pocket, 1 large interior pocket and 1 MP3 pocket
- New thicker 300 GSM non-pill deluxe fleece liner can be worn as a standalone jacket or along with outer shell for thermal protection down to -30°C

### PANTS

- Heavy-duty full length 2-way covered zippers for vented pant or tearaway options
- Wide elastic waist with hook and loop adjusters and removable suspenders
- Snap waist and zippered fly access

SAL396



SDN755



### JACKETS

Red/Black Model No.	Mfg. No.	Black Model No.	Mfg. No.	Navy Model No.	Mfg. No.	Size	Price /Each
SDN755	858JBR-S	SDN743	858JB-S	SDN749	858JN-S	Small	214.00
SDN756	858JBR-M	SDN744	858JB-M	SDN750	858JN-M	Medium	214.00
SDN757	858JBR-L	SDN745	858JB-L	SDN751	858JN-L	Large	214.00
SDN758	858JBR-XL	SDN746	858JB-XL	SDN752	858JN-XL	X-Large	214.00
SDN759	858JBR-2XL	SDN747	858JB-2XL	SDN753	858JN-2XL	2X-Large	228.00
SDN760	858JBR-3XL	SDN748	858JB-3XL	SDN754	858JN-3XL	3X-Large	228.00

### PANTS

Black Model No.	Mfg. No.	Size	Price /Each
SAL396	858PB-S	Small	102.00
SAL397	858PB-M	Medium	102.00
SAL398	858PB-L	Large	102.00
SAL399	858PB-XL	X-Large	102.00
SAL400	858PB-2XL	2X-Large	104.00
SAL401	858PB-3XL	3X-Large	104.00

## N-FERNO 6466 THERMAL JACKETS

- Rugged 500D nylon shell with breathable water repellent treatment to stay dry and comfortable
- 1600D nylon reinforcement zones in heavy wear areas to hold up through the toughest conditions
- Thermal insulated quilted sleeves for easy donning and doffing
- Exterior pockets include a back document pocket and a front cell phone pocket
- Interior audio pocket to hold cell phone or other device
- Heavy Duty YKK® zippers with storm flap to seal out wind and rain
- Removable hood with adjustable draw cords for a customizable fit
- Drawstring waist, adjustable hook & loop exterior cuffs, and spandex interior cuffs work together to keep out the wind, snow, and cold
- Reflective accents help keep workers safe and seen



Model No.	Mfg. No.	Size	Price/Each
SGH662	41112	Small	362.00
SGH663	41113	Medium	362.00
SGH664	41114	Large	362.00
SGH665	41115	X-Large	362.00
SGH666	41116	2X-Large	362.00
SGH667	41117	3X-Large	362.00

## N-FERNO 6471 THERMAL BIB OVERALLS

- Rugged 500D Nylon outer shell provides protection from the elements, repelling wind and water, and keeping out the cold
- 1600D Nylon reinforcement zones in heavy wear areas to hold up through the toughest conditions
- Several pockets including hip and chest for extra storage
- Full-length YKK® zippers on each leg to easily put on and take off without removing work boots
- Easily removable polyethylene foam knee/shin pads for convenience
- "Be Tenacious" non-slip, adjustable elastic straps for maximum comfort and the perfect fit
- Straight leg design with inside elastic bottom, snap closure liner to protect against snow and water
- Reflective accents help keep workers safe and seen



Model No.	Mfg. No.	Size	Price/Each
SGH668	41212	Small	345.00
SGH669	41213	Medium	345.00
SGH670	41214	Large	345.00
SGH671	41215	X-Large	345.00
SGH672	41216	2X-Large	345.00
SGH673	41217	3X-Large	345.00

## 6435 LONG SLEEVE THERMAL SHIRTS

- Ripped fit crew T-shirt in medium-weight wicking fabric for warmth
- Comfort design: raglan sleeves, stretch fabrics, flat seams
- Anti-stink treatment helps workers remain unscented
- Stretch fabric, brushed interior for warmth and comfort
- Moisture wicking treatments keep workers dry
- Thumb loops to keep sleeves in place and wind out
- Long tail design keeps you covered
- Colour: Black



Model No.	Mfg. No.	Size	Price/Each
SEC962	40203	Medium	71.50
SEC963	40204	Large	71.50
SEC964	40205	X-Large	71.50
SEC965	40206	2X-Large	71.50
SEC966	40207	3X-Large	71.50

## 6480 THERMAL PANTS

- Stretch fabric, brushed interior for warmth and comfort
- Moisture wicking treatments keep workers dry
- Stretch fabrics, flat seams and tagless waistband for comfort
- Anti-stink treatment helps workers remain unscented
- Colour: Black



Model No.	Mfg. No.	Size	Price/Each
SEC967	40803	Medium	51.40
SEC968	40804	Large	51.40
SEC969	40805	X-Large	51.40
SEC970	40806	2X-Large	51.40
SEC971	40807	3X-Large	51.40

## WELDING HELMETS

- Lightweight design with ratchet headgear
- Comes complete with shade 10 lens
- Choice of 2" x 4 1/4" flip front or 4 1/2" x 5 1/4" wide vision fixed front
- Passive lens
- Material: Thermoplastic



NT645



NT687



Model No.	Description	Window Dimensions"	Price /Each
NT645	Flip Front	2 x 4 1/4	29.95
NT687	Fixed Front	4 1/2 x 5 1/4	51.95

## WH10 PASSIVE WELDING HELMETS

- Narrow shell design is perfect for work in tight space
- Extended front increases throat protection against sparks, slag and other physical hazards
- Comes standard with cover plate and shade 10 polycarbonate filter plate
- Meets ANSI standard Z87.1 and compliant with CSA standard Z94.3



SD617



PB193



Model No.	Mfg. No.	Description	Colour	Price /Each
PB193	14982	HSL-2 Helmet, 2" x 4 1/4", Flip Front	Black	115.00
SD617	14975	HSL-100 Helmet, 4 1/2" x 5 1/4", Fixed Front	Black	113.00

## WH40 ELEMENT\* ADF WELDING HELMETS

- Lightweight shell weighs only 6 oz.
- Available in two different auto-darkening filters: ADF fixed shade 10 and ADF variable shade 9-13
- Two independent arc sensors
- Solar powered unit
- Meets ANSI standard Z87.1 and compliant with CSA standard Z94.3



SEA769



Model No.	Mfg. No.	Description	Price /Each
SEA769	23282	Welding Helmet-Variable ADF, 4.33" x 3.54"	292.00
SEA771	29127	Replacement Cover Lens Kit - Includes 5 Front and 2 Rear Safety Plates	23.80
SED982	23442	Replacement Headgear	23.90

## WH40 INSIGHT\* VARIABLE ADF WELDING HELMETS

- Get the high-level elements of a high-performance welding lens without the high price
- Offers an ADF with digital and multi-function controls for any welding job
- Sensitivity and delay adjustments
- Four independent sensors
- Easy-to-use digital controls
- Torch, grind and weld modes
- Variable shade: 9-13
- Viewing area: 3.93" x 2.36"
- Meets ANSI standard Z87.1 and compliant with CSA standard



SDP562



Model No.	Mfg. No.	Description	Price /Each
SDP562	40710	HSL100 Black w/Insight* ADF	407.00
SDP563	40709	Insight* ADF Cartridge, 4.5" x 5.25"	361.00
SDP564	41594	Internal Lens, 10/Pkg.	28.60
SDP565	41589	Replacement Cover Lens Kit - 5 Front and 2 Rear Safety Plates	23.50

## REBEL ADF WELDING MASK

- One-piece design protects against UV and IR leakage as well as spark and spatter penetration
- Engineered with the latest advancements in True Color technology
- Exclusive wrap-around face shield for added protection
- Compatible with prescription eyewear and Jackson Safety hard hats
- Hood is made using a high-performance flame-resistant fabric
- Easy-to-use digital ADF control system
- Battery life lasts up to 1300 hours (batteries replaceable)
- Meets or exceeds ANSI Z87.1, CAN/CSA Z94.3 standards and is CE certified
- Viewing Area: 3.5" L x 1.3" W
- Shade Level: 3/5-12



Model No.	Mfg. No.	Description	Price /Each
SGW859	46200	ADF Welding Mask	392.00
SHA441	46600	Replacement Fire-Resistant Hood	55.10

## INSIGHT DIGITAL VARIABLE ADF WELDING HELMET

- Variable shade 9-13 to shield and protect eyes from radiant energy during weld
- Viewing area of 3.94"x2.36" offers unobstructed vision during each stage of the welding process
- Ultra-lightweight shell helps reduce neck tension
- Easy to use digital controls
- Sensitivity and delay adjustments
- Choose from Weld and Grind modes
- Four independent sensors reduce blockage possibility
- Solar assist provides additional energy source
- Lithium batteries with easy access
- Colour: Black



Model No.	Mfg. No.	Description	Price /Each
SHA433	46131	Welding Helmet-Variable ADF	407.00

## TRANSLIGHT™ 555 + PREMIUM AUTO DARKENING WELDING HELMET

- Switching speeds of 1/25 000 sec increase comfort and keep eyes less fatigued
- Proprietary external shade adjuster finely tunes in .2 increments or +/- 1 full shades for unsurpassed visual precision
- ADF filter scores a perfect 1/1/1/1 optical clarity rating
- Engineered with the latest True Color technology to deliver a crystal-clear view of the weld
- 4 arc sensors provide superior coverage even when welding out of position
- Super lightweight design is ergonomically balanced to reduce stress and fatigue
- 12.47" square inches of viewing provide maximum peripheral vision
- External grinding button allows users to switch modes with ease
- Meets or exceeds ANSI Z87.1, CAN/CSA Z94.3 and is CE certified
- Colour: Black
- Viewing Area: 3.86" L x 3.23" W
- Shade Level: 3-1/2 - 14
- Filter DIMS: 5.25" x 4.5"
- ADF Weight: 7.6 oz.
- Total Weight: 1.35 lbs
- TIG Rating: >3A
- Control Type: Digital
- Manufacturer's Warranty: 3 Years



**JACKSON**  
SAFETY EQUIPMENT

Model No.	Mfg. No.	Description	Price /Each
SGZ288	46250	Auto Darkening Welding Helmet	625.00

## CARRERA™ HOODS

- Ultra-light and has a sleek, modern design, and its versatility and lens options make it a popular choice for seasoned welders and students alike
- Carrera™ ArcOne® Auto-Darkening lenses meet ANSI and CSA and are CE approved
- Shade Level: 9 - 13
- Light State: 4
- Amps: 25
- Number of Sensors: 2



**ARCONE**

Model No.	Mfg. No.	Viewing Area L" x W"	Description	Price /Each
NY219	1000F-0100	2 x 3	Black	199.00
NY220	1000F-0110	2 x 3	Charcoal	225.00
NY221	1000F-0141	2 x 3	Blue	225.00
NY223	1000F-0171	2 x 3	Fighting Tiger Graphics	225.00
NY224	4500V-0100	3 x 4	Black	225.00
NY225	4500V-0110	3 x 4	Charcoal	255.00
NY226	4500V-0141	3 x 4	Blue	255.00
NY227	4500V-0166	3 x 4	Top Gun Graphics	255.00
NY228	4500V-0171	3 x 4	Fighting Tiger Graphics	255.00



## TRANSLIGHT™ 455 FLIP PREMIUM AUTO DARKENING HELMET

- Best in class switching speeds of 1/40000 sec maximize comfort and decrease eye fatigue
- Easy-to-use lift mechanism reveals a 46 sq. inch clear face shield for grinding operations
- ADF filter scores a perfect 1/1/1/1 optical clarity rating
- Engineered with the latest True Color technology to deliver a crystal-clear view of the weld
- 4 arc sensors provide superior coverage even when welding out of position
- Super lightweight design is ergonomically balanced to reduce stress and fatigue
- 9.65 sq. inch viewing area provides maximum peripheral vision
- Powered by solar technology and two CR2032 replacement batteries
- Meets or exceeds ANSI Z87.1, CAN/CSA Z94.3 and is CE certified
- Colour: Black



**JACKSON**  
SAFETY EQUIPMENT

Model No.	Mfg. No.	Description	Price /Each
SHA434	46240	Auto Darkening Helmet	644.00

## HAWK® WELDING HELMET

- One of the lightest helmets, comfortable for all day use
- Provides excellent head, neck and ear coverage
- Colour: Black
- Viewing Area: 2" L x 4" W
- Shade Level: 10
- Light State: 2.5
- Amps: 50
- Number of Sensors: 2



**ARCONE**

Model No.	Mfg. No.	Description	Price /Each
NY234	S240-10-0300	Welding Helmet	215.00

## VISION® HOODS

- Ultra-light, slim and will fit into tight areas, all while offering optimal face, ear and neck coverage
- Ideal for low amp TIG welding and are dust and water resistant to handle the toughest of conditions
- Viewing Area: 4.25" L x 4" W
- Shade Level: 5 - 13
- Viewing Area: 17 sq. in.
- Light State: 3
- Amps: 5
- Number of Sensors: 3



**ARCONE**

Model No.	Mfg. No.	Description	Price /Each
NY230	BFFVX-1500	Black	535.00
NY231	BFFVX-1523	Speedway Graphics	579.00
NY232	BFFVX-1555	Tank Graphics	579.00
NY233	BFFVX-1579	El Diablo Graphics	579.00



## PANORAMAXX WELDING HELMET

- Unique ADF profile expands view 6x compared to traditional helmets, yet remains lightweight
- Shade level 2.5/5-12; brightest view in light state and grind mode
- Autopilot detects arc intensity and adjusts shade level during welding, cutting and grinding
- True Color optics for best colour and detail perception
- Twilight opening delay restores light more naturally, presenting a smoother transition to the eye
- New rechargeable power-pack uses solar panels and USB
- Curved helmet design deflects smoke and debris, optimized for overhead welding
- Certification: CSA Z94.3

SGC191



Model No.	Mfg. No.	Description	Price /Each
SGC191	1010.000	Panoramaxx Welding Helmet	853.00
SGC192	5000.270	Front Cover Lens, 5/Pkg.	63.50
SGC193	5000.010	Inner Cover Lens, 5/Pkg.	28.30
SGC194	5000.150	Magnification Lens, 1.00 Diopter	56.90
SGC195	5000.151	Magnification Lens, 1.50 Diopter	56.90
SGC196	5000.152	Magnification Lens, 2.00 Diopter	56.90
SGC197	5000.153	Magnification Lens, 2.50 Diopter	56.90

## P550 WELDING HELMETS

- Optimized cover lens for perfect protection against spatters and fumes
- Enlarged LCD provides a comfortable viewing area
- True-Color optics; specially developed UV/IR filter allows a realistic perception of colors
- Shade level 4/9-13 with external control for quick adjustment
- Adjustable sensitivity and opening delay
- Power by solar cells and two lithium batteries
- Application range: All electric arc welding processes
- Prohibited for overhead welding and laser/gas welding
- Complies with CSA standard Z94.3
- 2-year warranty

SED542



SGC231



### HELMETS

Model No.	Mfg. No.	Description	Colour	Price /Each
SED542	1007.000	Neo Black/Black w/graphics	Black	404.00
SGC231	1007.011	Neo Black/Green w/graphics	Black/Green	404.00
SED546	5012.700	Replacement Auto-Darkening Filter	-	343.00

### ACCESSORIES

Model No.	Mfg. No.	Description	Qty /Pkg.	Price /Each
<b>COVER LENSES</b>				
SAX006	5000.001	Inside Cover Lenses	5	15.30
SED552	5000.250	Front Cover Lenses	5	29.20
<b>MAGNIFICATION LENSES</b>				
SAX008	5000.050	1.00 Diopter	1	54.90
SAX009	5000.051	1.50 Diopter	1	54.90
SAX010	5000.052	2.00 Diopter	1	54.90
SAX011	5000.053	2.50 Diopter	1	54.90

## LITEFLIP AUTOPILOT WELDING HELMETS

- The first flip-up helmet with Autopilot shade selector
- Shade levels 1/4/5-14 with True-Color optics
- Adjustable sensitivity and opening delay
- Powered by solar cells and two lithium batteries
- Application range: all electric arc welding processes
- Prohibited for overhead welding and laser/gas welding
- Certification: ANSI Z87.1, complies with CSA Z94.3
- 2+1 year warranty

SGC188



Model No.	Mfg. No.	Description	Price /Each
SGC188	1006.700	Liteflip Welding Helmet	749.00
SAX006	K6024	Inside Cover Lens, 5/Pkg.	15.30
SGC189	5000.390	Safety Grinding Lens, 5/Pkg.	28.00
SGC190	5000.391	Front Lens, 5/Pkg.	28.00

## E684 WELDING HELMETS

- Adaptive shade autopilot automatically adjusts the shade level as one welds
- Third sensor detects changes in arc intensity and adjusts shade level accordingly
- Twilight ADF technology restores light more naturally, presenting a smoother transition to the eye
- High definition viewing
- True colour filter optimizes view of colours in true form
- Curved helmet optimized for overhead welding
- Shade Level : 4/5-13
- Complies with CSA standard Z94.3



SAM898



SAX011



SFI934



Model No.	Mfg. No.	Description	Colour	Price /Each
SFI934	1006.500	e684 Helmet	Silver	853.00
SFU861	1006.501	e684 Helmet	Black	853.00
SFU862	1006.502	e684 Helmet	Dark Blue	853.00
SFI935	5012.480	Replacement Auto-Darkening Filter	-	760.00

### ACCESSORIES

Model No.	Mfg. No.	Description	Qty /Pkg.	Price /Each
SAM897	5000.210	Front Cover Lenses	2	24.10
SAM898	5000.212	Front Cover Lenses	5	55.90
SAX006	5000.001	Inside Cover Lenses	5	15.30
SAX008	5000.050	Magnification Lens, 1.00 Diopter	1	54.90
SAX009	5000.051	Magnification Lens, 1.50 Diopter	1	54.90
SAX010	5000.052	Magnification Lens, 2.00 Diopter	1	54.90
SAX011	5000.053	Magnification Lens, 2.50 Diopter	1	54.90
616-1570	5003.250	Replacement Headgear	1	57.50

## CRYSTAL 2.0 AUTO DARKENING WELDING HELMET

- Crystal Lens Technology and Optrel Autopilot work together to assure a clear view with the right level of protection
- Features high-contrast, true colour vision
- Powered by solar cells and 2 lithium batteries (CR2032)
- Features a 'bright to dark' switching time of 0.100 ms at room temperature and 0.070 ms at 55°C
- Features a 'dark to bright' switching time of 0.1 s to 2.0 s
- Inactive Shade Level: 2
- Active Shade Levels: 4-12
- Weight: 460 g



Model No.	Mfg. No.	Description	Price /Each
SGP709	1006.900	Crystal 2.0 Auto-Darkening Helmet	973.00
SGP711	5001.690	Crystal 2.0 Welding Helmet Shell	210.00
SGP710	5012.900	Replacement Auto-Darkening Cartridge	831.00

## CRYSTAL 2.0 WELDING HELMET WITH E3000 PAPR SYSTEM

- Powered Air Purifying Respirator system (PAPR) alleviates harsh working conditions caused by smoke, dust and vapors
- PAPR system combined with Optrel auto-darkening welding helmet is a combination that provides maximum safety and comfort
- Provides continuous monitoring of airflow by integrated sensor during entire welding process
- Head Gear: Welding Helmet
- Battery Type: Lithium-Ion
- Colour: Dark Blue
- Power Source: Battery



Model No.	Mfg. No.	Description	Price /Each
SGP712	4530.051	Welding Helmet w/ E3000 PAPR System	3238.00

## NOVA AUTO-DARKENING FILTERS

- Automatically darken to shade 10
- Fits most competitive 2" x 4 1/4" openings
- Solar powered
- 2-year warranty



Model No.	Mfg. No.	Price /Each
SAI757	5012.238	286.00

## VEGAVIEW 2.5 WELDING HELMETS

- Brightest view in light state and grind mode at shade level 2.5
- Shade level 2.5/8-12
- External infinite shade level adjustment enables welders to manually adjust their shade level from 8-12
- True colour filter optimizes view of colours in true form
- Sensitivity control prevents ADF from responding too soon or not at all to their arc flash
- Opening delay allows welders to adjust the time it takes to switch from dark to light
- Curved helmet optimized for overhead welding
- Meets CSA standard Z94.3
- 2-year warranty



Model No.	Mfg. No.	Description	Colour	Price /Each
SFI930	1006.600	Vegaview2.5 Helmet	Black Unpainted	637.00
SFI931	5012.470	Replacement Auto-Darkening Filter	-	594.00

### ACCESSORIES

Model No.	Mfg. No.	Description	Qty/Pkg.	Price/Each
SAM898	5000.212	Front Cover Lenses	5	55.90
SAM901	5000.300	Inside Cover Lenses	5	15.00

## WELDCAP®

- Combines the lightweight wear comfort of a baseball cap with full protection of an ADF welding helmet
- Lightweight, flame-retardant textile is soft where it must be comfortable, robust plastic is rigid where it must be tough
- Well-defined nose cut out places the lens closer to the eyes, enlarges the welder's line of sight by 2.7 times
- Weighs less than 14 ounces
- Sleek profile ideal for welder working in confined spaces
- Grind mode shade 3
- Shade level 3/9-12
- Meets Z87.1+ standard for impact resistance



Model No.	Mfg. No.	Description	Qty /Pkg.	Price /Each
SEK224	1008.000	Weldcap®	1	324.00
SEK225	5000.260	Front Cover Lens	5	45.10
SEK226	5000.040	Inside Cover Lens	5	17.80
SEK227	5002.700	Nose Clip	2	17.80
SEK228	5002.800	Replacement Textile Cap	1	137.00
SEK229	5002.720	Battery Cover	2	16.00
SEK230	5002.900	Parking Buddy Belt Clip	1	31.70



## SPEEDGLAS™ 9002NC ADF WELDING HELMET



- Precision optics, which provide a view that appears lighter, brighter and more realistic, giving you better control of the weld puddle
- A more comfortable suspension for longer wear time
- Lighter weight, better for longer wearing, just 17 oz.
- Slim fit, better for tight spots
- Simplified UI, easy to operate and maintain
- ADF Shade Range: Variable 8-12
- DF Viewing Area (h x w): 2.13 x 4.09"
- Battery Life: 2000 hours
- Battery Type: ADF: CR2032
- Colour: Black/Silver



Model No.	Description	Price /Each
SGF164	Welding Helmet & Filter	516.38
SGF166	Welding Helmet Only	210.01
SGF165	Welding Filter Only	396.48

## SPEEDGLAS™ 9100 WELDING HELMET & AUTO-DARKENING FILTER 9100XXI



- Grab and go with auto-on
- Two memory modes that allow you to set individual settings for dark shade
- Arc detection sensitivity is adjustable
- Delay function to set the dark-to-light opening time
- External grinding mode activation
- Adjustable head suspension increases comfort and stability
- Side windows help increase peripheral vision
- Welding cap, carry bag, and starter kit included
- Battery Life: Up to 1800 hours
- Meets ANSI Z87.1-2010



Model No.	Mfg. No.	Description	Price /Each
SGC239	06-0100-30ISW-CA	Speedglas™ 9100 Welding Helmet & Auto-Darkening Filter 9100XXi	922.60
SGC237	06-0000-30I-CA	Speedglas™ Auto Darkening Filter 9100XXi	898.93
SGC238	06-0000-30I-KIT-CA	Speedglas™ Auto Darkening Filter 9100XXi with Silver Front Panel	895.06

## SPEEDGLAS™ G5-02 WELDING HELMET KIT



- Features a revolutionary curved glass auto-darkening filter (ADF) with variable dark shades 8-12
- Offers 3M's largest auto-darkening filter field of view ever (150 mm) by utilizing 3M™ Speedglas™ Curved Glass Technology
- Great clarity and colour recognition before, during, and after welding thanks to 3M™ Speedglas™ Natural Colour Technology
- Customizable settings can help reduce eye strain and can improve weld quality
- The sensitivity of arc detection can be adjusted for exceptional switching reliability
- Bluetooth® functionality pairs with the 3M™ Connected Equipment App, giving users access to additional functionalities, statistics, and documentation
- Colour: Black
- Sensitivity: 5 Level (TIG>1A & MIG/MAG, Stick)



Model No.	Mfg. No.	Description	Price /Each
SHC095	08-0100-50IC	Welding Helmet Kit	1661.13
SHC098	08-0300-52	Welding Helmet Shell	92.12
SHC099	08-0400-51	Head Suspension Assembly	82.54
SHC094	08-0000-50IC	Darkening Filter with Inner & Outer Protection Plates	1547.88
SHC106	SG-96	Welding Helmet Bag	46.43



## ADFLO™ HIGH-ALTITUDE PAPR SYSTEM WITH SPEEDGLAS™ WELDING HELMETS

- Large, clear protective visor is curved, providing excellent viewing angles up, down, and peripherally
- A slim profile makes the helmet lightweight and easy to utilize in tight welding spaces
- With the right type of filter and/or cartridge, the assembly effectively protects against both particles and gases
- Helmet lets you direct the airflow to either your face, visor, or somewhere in-between for more comfort control
- Model **SGT319** filter features Variable Color Technology that allows welders to select between 3 different colour options (clear, cool, or warm), improving their ability to see the weld puddle, joint and arc
- Includes: Speedglas™ heavy-duty welding helmet with auto-darkening filter, Adflo™ high-altitude PAPR system, Lithium-ion battery, Charger, High-efficiency particulate filter & prefilter, Spark arrester, Wide leather belt, Self-adjusting breathing tube
- Sensitivity: 5 Level (TIG>1A and MIG/MAG, Stick)
- Battery Life: 7-9 Hrs.
- Standards/Approvals: ANSI Z87.1-2015, CSA Z94.3 and NIOSH Approved



Model No.	Mfg. No.	Welding Helmet	Price /Each
SGT318*	46-1101-00	G5-01	2717.65
SGT319	46-1101-301VC-CA	G5-01VC	3613.42
SGT321	46-1101-301-CA	G5-01VC	3561.18

\* Auto-darkening filter not included

## POWERED AIR RESPIRATOR

- High efficiency particulate respiratory protection system for welders
- Welding helmet 9100-Air with auto-darkening filter offers the welder compact, lightweight respiratory protection and quality filter optics all-in-one
- SideWindows: Shade 5 side filters that increase peripheral vision
- Ergonomic, adjustable head suspension for increased comfort, helmet stability and weight distribution
- Selectable shades 5, 8-13 and Shade 3 light state; grinding and tack modes
- 5-position sensitivity control
- Adjustable recovery delay
- Solar panel
- Storage bag, do-rag and starter kit included
- Meets ANSI Z87.1 and approved to CSA Z94.3 for eye and face protection
- Approved for use in all stick, MIG and TIG applications
- Breathing tube is SG-30W
- Offers assigned protection factor (APF) of 25 when used as a NIOSH-approved system



Model No.	Mfg. No.	Lens Type	Viewing Area L" x W"	Battery Life Time (hrs)	Solar Cell	Price /Each
SGC259*	35-1101-301SW-CA	V	2.8 x 4.2	2000	Yes	3594.51

\* Natural colour auto darkening filter



### REPLACEMENT FILTERS & CARTRIDGES

Model No.	Mfg. No.	Description	Price /Each
SAN357	15-0009-99X02	2-pack Adflo™ Spark Arrestor	21.95
SAN358	15-0099-99X06	6-pack Adflo™ Prefilter	31.27
SAN359	15-0099-99X12	12-pack Adflo™ Prefilter	56.85
SGC315	15-0299-99X20	1-pack Adflo™ HE Particle Filter	96.32
SAN360	15-0299-99X02	2-pack Adflo™ HE Particle Filter	215.24
SAN363	15-0499-99X02	2-pack Adflo™ OV/SD/CL/HC Cartridge	331.36
SAN364	15-0499-99X06	6-pack Adflo™ OV/SD/CL/HC Cartridge	911.36

## SPEEDGLAS™ ACCESSORIES

- **Protective bag** used to help protect the Speedglas™ helmets assembly when not in use
- **Full hood** for use with Speedglas™ welding helmets to provide additional protection to the user from welding spark and spatter on the top portion of the head, neck and shoulders
- Hood is made of 75% FR cotton and 25% Kevlar synthetic fiber



Model No.	Mfg. No.	Description	Price /Each
SEJ119	06-0500-65	Protective Bag	54.33
SEE884	06-0700-83	Full Hood	215.03



SEJ119



SEE884

# WELDING PROTECTION

## FILTER PLATE LENSES

- Provides ultimate protection against ultraviolet and infrared rays present during the welding process
- Attenuates varying proportions of ultraviolet, visible and infrared rays in conformance with industry standards
- Precision ground and edged to allow a proper and safe fit
- Optically correct and precisely shaded
- Hardened glass

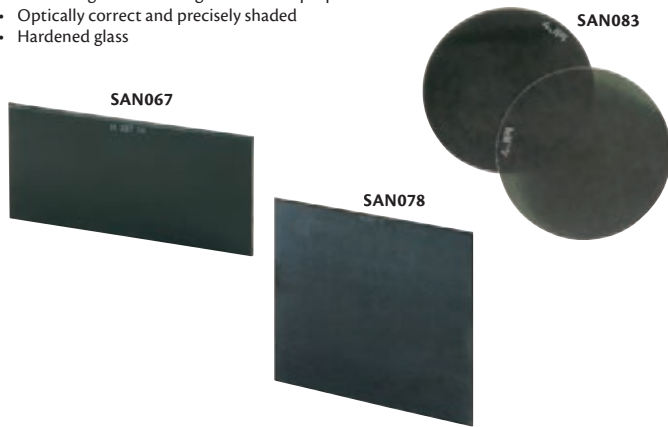

Model No.	Mfg. No.	Shade	Price /Each
2" x 4 1/4"			
SAN061	FS-1H-4	4	1.69
SAN062	FS-1H-5	5	3.89
SAN063	FS-1H-6	6	3.19
SAN064	FS-1H-7	7	3.29
SAN065	FS-1H-8	8	3.89
SAN066	FS-1H-9	9	3.89
SAN067	FS-1H-10	10	3.89
SAN068	FS-1H-11	11	3.89
SAN069	FS-1H-12	12	3.89
SAN070	FS-1H-13	13	3.39
SAN071	FS-1H-14	14	3.29

Model No.	Mfg. No.	Shade	Price /Each
4 1/2" x 5 1/4"			
SAN073	FS-5H-5	5	8.39
SAN074	FS-5H-6	6	4.49
SAN075	FS-5H-7	7	4.49
SAN076	FS-5H-8	8	8.19
SAN077	FS-5H-9	9	8.19
SAN078	FS-5H-10	10	8.19
SAN079	FS-5H-11	11	8.19
SAN080	FS-5H-12	12	8.39
SAN081	FS-5H-13	13	7.09
SAN082	FS-5H-14	14	6.59
50 MM			
SAN083	FL-5H-4	4	5.19
SAN084	FL-5H-5	5	6.19

## MAGNIFYING LENSES

- Makes a welder's work easier and more comfortable
- Useful for precision welding jobs
- Offers optically balanced magnifications in 0.25 increments
- 2" x 4 1/4"

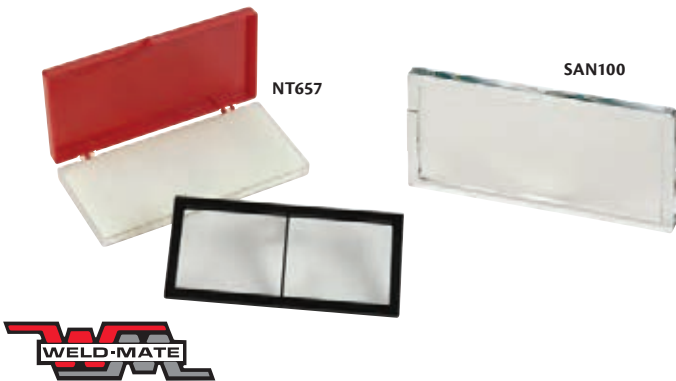

Model No.	Diopter Strength	Price /Each
GLASS		
NT652	0.75	6.20
NT653	1.00	6.20
NT654	1.25	6.20
NT905	1.50	6.45
NT655	1.75	6.20
NT656	2.00	6.95
NT657	2.25	6.75
NT658	2.50	6.95
NT659	3.00	6.95

Model No.	Diopter Strength	Price /Each
PLASTIC		
SAN095	1.00	12.50
SAN096	1.25	16.50
SAN097	1.50	16.50
SAN098	1.75	16.50
SAN099	2.00	16.50
SAN100	2.25	14.50
SAN101	2.50	16.50

## CLEAR COVER LENSES

- Polycarbonate lenses are for eye protection against light impact such as sparks and small particles
- Cast resin lenses are also for eye protection and are more resistant to heat, scratching and pitting
- Clear glass lenses are not impact resistant and are only for use against spatter



Model No.	Mfg. No.	Size	Price /Each
POLYCARBONATE			
NT601		2" x 4 1/4"	0.86
NT602		4 1/2" x 5 1/4"	1.96
CAST RESIN			
SAN055	PP-2	2" x 4 1/4"	2.29
SAN056	PP-4	4 1/2" x 5 1/4"	6.09
CLEAR GLASS			
SAN058	GP-2	2" x 4 1/4"	0.89
SAN059	GP-4	4 1/2" x 5 1/4"	1.49

## OMNI-VIEW® GOLD FILTER PLATES

- Made of breakage resistant polycarbonate
- Allows welder to see more in clearer and natural colours
- Gold coating reflects harmful infrared generated by an arc, keeping eyes cooler and more comfortable

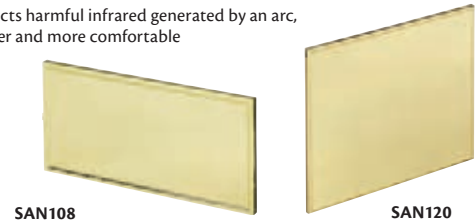

Model No.	Mfg. No.	Shade	Price /Each
2" x 4 1/4"			
SAN106	FP2G-8	8	25.50
SAN108	FP2G-10	10	28.90
SAN109	FP2G-11	11	25.50
SAN110	FP2G-12	12	15.90

Model No.	Mfg. No.	Shade	Price /Each
4 1/2" x 5 1/4"			
SAN117	FP4G-8	8	48.90
SAN118	FP4G-9	9	59.50
SAN119	FP4G-10	10	59.50
SAN120	FP4G-11	11	59.50
SAN121	FP4G-12	12	59.50

## MILLER®/HOBART® COMPATIBLE AUTO-CHANGE COVER LENSES

- Replacement lenses provide an effective and cost efficient method of protecting investment
- Made of 100% impact-resistant polycarbonate



Model No.	Mfg. No.	Type of Lens	Qty /Package	For Use with Helmets*	Price /Each
TTU323	231410/770237	Inside/Outside	5	FS/XL/Xli/Xlix/Performance	16.59
TTU324	770240	Outside	5	XL/Xli	21.19
TTU325	770241	Outside	5	Xlix	23.49
TTU326	216327	Inside	5	Elite/Digital Elite	16.39
TTU327	216326	Outside	5	Elite/Digital Elite	25.19
TTU328	231410	Inside	5	Pro-Hobby	16.89
TTU329	231411	Outside	5	Pro-Hobby	21.90
TTU330	231921	Outside	5	Performance	23.49

\*Trademarks and trade names are the property of their respective owners

## FLEXIBLE FRAME GOGGLES

- Soft PVC frame seals out light leaks
- Choice of 2" x 4 1/4" fixed front or flip front design
- Comes complete with shade 5 lens



NT646



NT647



Model No.	Description	Price /Each
NT646	Fixed Front	8.95
NT647	Flip Front	11.25

## Z1100 SERIES WELDING SAFETY GOGGLES

- Can be used over most prescription eyewear
- Wrap-around style provides excellent 180° panoramic vision
- Extremely flexible soft PVC goggle body for greater comfort
- Impact resistant polycarbonate lens
- Anti-fog lens is ideal for high humidity applications
- Indirect vent increases air flow and protects against dust, fumes and chemical splash
- Adjustable elastic headband
- Ventilation Type: Indirect
- Lens Coating: Anti-Fog
- Standard(s) Met: ANSI Z87+, CSA Z94.3



SGR808



Model No.	Lens Tint	Price /Each
SGR808	3.0	15.25
SGR809	5.0	18.15

## V-MAXX™ GOGGLES

- Sport wrap-around style
- Direct vent for impact resistance and indirect vent for chemical splash applications
- OTG compatible
- 180° clear field of vision
- Lenses coated with Fog-ban® anti-fog coating
- Pivoting headband clips to adjust strap around hardhats or hearing protection
- Adjustable elastic or neoprene headband
- Certified to CSA standard Z94.3



SAI908



Model No.	Mfg. No.	Description	Lens Tint	Price /Each
SAI908*	11250850	Indirect Vent, Black Frame and Headband	Shade 5.0	26.40
SAI905*	11250800	Direct Vent, Red Headband	Clear, Fog-ban®	9.78
SAI906	11250810	Indirect Vent, Black Neoprene Headband	Clear, Fog-ban®	11.60

\* Elastic Headband

## CUP GOGGLES

- Rigid 2" (50 mm) round lens cup goggle
- Comes complete with shade 5 lens



Model No.	Price /Each
NT648	7.95

## V80 WILDCAT\* GOGGLES

- Extreme heat resistance, will not melt, drip or ignite at 350°F for five minutes
- Adjustable side vents to help increase airflow
- Fits naturally to the contour of your face
- Lightweight and comfortable with a pivot headband that allows for optimal placement
- Meets ANSI standard Z87.1+ and compliant with CSA standard Z94.3



TTT946



TTT947



TTT950



Model No.	Mfg. No.	Lens Tint	Price /Each
TTT946	20525	Clear Anti-Fog	21.30
TTT947	20526	Smoke Anti-Fog	21.00
TTT949	20528	Shade 3.0 Anti-Fog	33.80
TTT950	20529	Shade 5.0 Anti-Fog	34.90

## V90 SHIELD\* GOGGLES

- Features the Monogoggle® XTR\* with indirect ventilation and a polycarbonate shield for full face protection
- Shield detaches from the goggles
- Curved face shield conforms to shape of face offering added protection
- Can be used over most prescription eyeglasses
- Meets ANSI impact standard Z87.1+



TTT955



TTT954



Model No.	Mfg. No.	Lens Tint	Price /Each
TTT954	18629	Clear Anti-Fog	34.90
TTT955	18631	Shade 3.0 Anti-Fog	48.80



# WELDING PROTECTION

## LAVA BROWN LEATHER JACKETS

- Designed to allow complete body movement and freedom
- Heat and flame-resistant leather is made from durable side split cowhide
- Seams are double lock-stitched
- Includes full-sized pocket and multiple-snap adjustment cuffs
- Roll-up collar stops shooting spatter

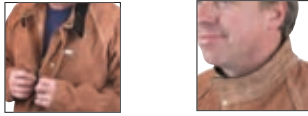

Model No.	Size	Chest Measurements	Price /Each
TTU398	Medium	40-42"	189.00
TTU399	Large	44-46"	189.00
TTU400	X-Large	48-50"	189.00
TTU401	2X-Large	52-54"	205.00
TTU402	3X-Large	56-58"	220.00
TTU403	5X-Large	64-66"	259.00

## LAVA BROWN LEATHER ACCESSORIES

- Designed to allow even weight distribution on the user to reduce fatigue
- Heat and flame-resistant leather is made from durable side split cowhide
- Certification: EN ISO 11611:2015 Class 2/A1+A2



Model No.	Size	Price/Each
<b>A. SLEEVE</b>		
TTU389	23" L, Pair	70.30
<b>B. CAPE SLEEVES</b>		
TTU407	Small	115.00
TTU405	Medium	115.00
TTU406	Large	115.00
TTU408	X-Large	115.00
TTU409	2X-Large	125.00
TTU410	3X-Large	135.00
<b>C. BIBS</b>		
TTU411*	14" L	24.10
TTU412	20" L	33.10
<b>D. SPLIT LEG APRONS &amp; CHAPS</b>		
TTU396*	42" L	89.25
TTU397	48" L	99.75
TTU404	Chaps	89.99
<b>E. WAIST APRONS</b>		
TTU392	24" L	41.75
<b>F. BIB APRONS</b>		
TTU393	36" L	63.75
TTU394	42" L	70.25
TTU395	48" L	82.50
<b>G. SPATS</b>		
TTU390	6" L, Pair	35.20
TTU391	14" L, Pair	75.00



F.



G.

## PROBAN WELDING JACKETS

### COOL PROTECTION, COOL LOOK!

- Superior flame, heat and abrasion-resistant, select cowhide sleeves for heavy-duty protection
- 30" length jacket made of black 9-oz. Proban FR-7A flame-retardant cotton sateen for safety and cool comfort
- Five-snap closure front minimizes hot shooting spatter from entering
- Inside utility pocket for safety and convenience



Model No.	Size	Chest Measurements	Price /Each
TTV013	Medium	40-42"	82.95
TTV014	Large	44-46"	82.95
TTV015	X-Large	48-50"	82.95
TTV016	2X-Large	52-54"	89.40
TTV017	3X-Large	56-58"	99.10
TTV018	5X-Large	64-66"	115.00

## GOLDEN BROWN LEATHER JACKETS

- Made of heat and abrasion-resistant select split cowhide
- Sewn with Kevlar® thread for added seam strength
- Roll-up collar with velcro closure and welted shoulder seams
- Reinforced double leather snap panel



Model No.	Size	Chest Measurements	Price /Each
TTU384	Medium	40-42"	118.00
TTU385	Large	44-46"	118.00
TTU386	X-Large	48-50"	118.00
TTU387	2X-Large	52-54"	129.00
TTU388	3X-Large	56-58"	139.00

## FLAME RETARDANT CLOTHING

- Manufactured from flame-retardant treated cotton sateen
- Will retain its flame-retardant properties for up to 50 normal washings
- Specially-designed underarm sport cut and hemmed collar
- 9-oz. jackets include inside pocket and five snaps
- 9-oz. cape sleeves come with six snap fasteners for bib (sold separately) and conform to ASTM D6413-13b

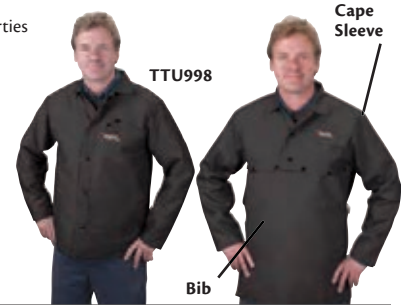

Model No.	Size	Chest Measurements	Price /Each
<b>JACKETS</b>			
TTU998	Medium	40-42"	54.95
TTU999	Large	44-46"	54.95
TTV001	X-Large	48-50"	54.95
TTV002	2X-Large	52-54"	59.95
TTV003	3X-Large	56-58"	65.95
TTV004	5X-Large	64-66"	75.95
<b>CAPE SLEEVES</b>			
TTV005	Medium	40-42"	35.65
TTV006	Large	44-46"	35.65
TTV007	X-Large	48-50"	35.65
TTV008	2X-Large	52-54"	39.20
TTV009	3X-Large	56-58"	43.00
<b>BIB &amp; SLEEVES</b>			
TTV010	20" Length Bib	-	12.35
TTV011	18" Long Sleeve, Pair	-	12.55
TTV012	23" Long Sleeve, Pair	-	15.70

## WELDERS' CAPS

- Athletic mesh lining to allow sweat vapour to quickly evaporate
- Pre-shrunk and pre-softened lightweight fabric, flame retardant until washed
- Air cushioned front lining for comfort and sweat absorbency
- **Sold per package**

Assorted styles include:

Happy Hour, Paradise, Camo, and Wild



Camo

Happy Hour



Paradise



Camo



Wild



Model No.	Diameter	Qty /Pkg.	Price /Each
<b>ASSORTED</b>			
NT838	7 1/8"	12	75.55
NT839	7 1/4"	12	75.55
NT840	7 3/8"	12	75.55
NT841	7 1/2"	12	75.55
NT842	7 5/8"	12	75.55
<b>CAMO</b>			
NT843	7 1/8"	12	77.10
NT844	7 1/4"	12	77.10
NT845	7 3/8"	12	77.10
NT846	7 1/2"	12	77.10
NT847	7 5/8"	12	77.10

## WELDERS' DOORAGS

- Athletic mesh lining to allow sweat vapour to quickly evaporate
- Pre-shrunk and pre-softened lightweight fabric, flame retardant until washed
- Air cushioned front lining for comfort and sweat absorbency
- Assorted styles
- One size fits all
- **Sold per package**



Wild



Camo

Happy Hour



Paradise



Camo



Wild



Model No.	Assorted Styles	Qty/ Pkg.	Price /Each
NT835	Camo, Wild, Happy Hour	12	92.35
NT836	Happy Hour, Paradise, Wild	12	92.35
NT837	Camo, Wild	12	92.35

## PROFLEX 360 HARD SHELL HINGED KNEE PADS

- Features an ergonomic hinge design built to keep protection comfortably in place whether walking, crawling or kneeling
- Equipped with heavy-duty shell and buckles for long-lasting use on tough worksites
- Thick closed-cell foam padding supports and cushion joints
- Straps sit further apart on thigh and calf to prevent uncomfortable binding
- Heavy-duty shell combined with non-marring cap makes for optimal performance on both abrasive surfaces and delicate surfaces
- Soft cap completely covers knee to maximize stability and prevent floors from becoming marked or scratched
- Thick elastic straps easily adjust for custom fit
- Durable locking buckles securely latch to prevent knee pads from sliding around when on the move
- Closure Type: Buckle
- Pad Type: Foam
- Cap Material: Rubber
- Colour: Black

Model No. SHC108  
Mfg. No. 18360  
Price/Each \$55.50



## HEADGEAR PADS & SWEATBANDS

- Field tested to improve helmet grip with maximum perspiration absorption
- STET pads are flame retardant for added safety
- Made of an absorbent air cushioned layer lined with 10% fleece cotton
- Velcro fastening system is designed to fit all major brands of headgear
- Sweatbands come with elastic strap
- **Sold per package of two**



Suspender headgear



Sweatband



Non-suspender headgear

Model No.	Description	Price /Each
620-3200V	Suspender Pads For Use With Hard Hats	4.55
SAM548	Sweatbands	4.55
620-3100V	Non-Suspender Pads For Use With Welding Helmets	4.55

## WELDING KNEE PADS

- Made of heat-resistant leather
- Flexible non-skid cap designed to stand up to the everyday demands of the welding environment
- Ideal for welding as well as high heat applications such as smelters and foundries
- **Sold per pair**
- Model No. SM777  
Mfg. No. 6991-01Q  
Price/Each \$107.00



## LEATHER KNEE PADS

- Tough abrasion-resistant leather for maximum protection and soft cushion back for comfort
- Elastic straps with velcro closures ensure a secure fit resistant to heat and fire
- Ideal for welders or any construction application such as concrete work
- **Sold per pair**
- Model No. SAL218  
Mfg. No. 6991  
Price/Each \$64.60



## COTTON WELDERS' BEANIES

- Flame retardant cotton
- Added protection under welding helmet
- Two colours (black and white)
- One size fits all
- Imprint available with minimum quantity
- Model No. SEE845  
Price/Each \$1.30



SEE PAGES 357-379  
FOR OUR FULL CLOTHING LINE.

# WELDING PROTECTION

## WELDERS' DEERSKIN TIG GLOVES

- Premium split deerskin leather construction
- Designed for precision welding applications
- Superior fit and dexterity
- Double thumb strap extends wear life
- 4" gauntlet cuff provides superior protection
- Exceptionally soft finish
- Clute cut pattern with straight thumb style
- Sewn with DuPont® Kevlar® thread for higher seam strength and seam flame resistance

Model No.	Size	Price /Each
SM597	Small	16.75
SM598	Medium	15.60
SM599	Large	15.90
SM600	X-Large	18.15
SAP293	2X-Large	19.25



## WELDERS' STANDARD QUALITY GLOVES

- Rugged split cowhide leather construction
- Excellent abrasion resistance
- Thermal cotton palm lining provides added heat protection
- Weltered seams at all critical points
- Sewn with DuPont® Kevlar® thread for higher seam strength and seam flame resistance

SAO130



Model No.	Description	Style	Size	Price /Each
SAO130	Gloves	Gunn & Wing	Large	7.60
SAO131	One-Finger Mitt	Clute & Wing	Large	7.85

## WELDERS' PIGSKIN TIG GLOVES

- Premium grain pigskin leather construction
- Designed for precision welding applications
- Excellent fit and dexterity
- Exceptional durability
- Double thumb strap extends wear life
- 4" gauntlet cuff provides superior protection
- Clute cut pattern with straight thumb style
- Sewn with DuPont® Kevlar® thread for higher seam strength and seam flame resistance

Model No.	Size	Price /Each
SAN639	Small	10.65
SAN640	Medium	11.30
SAN641	Large	11.50
SAN642	X-Large	11.90



## OUTSIDE DOUBLE PALM & THUMB WELDER'S GLOVES

- Top split cowhide leather construction
- Excellent abrasion resistance
- Outside double palm and thumb extend wear life
- Thermal cotton palm lining provides added heat protection
- Weltered seams at all critical points
- Sewn with DuPont® Kevlar® thread for higher seam strength and seam flame resistance

SAO129



Model No.	Description	Style	Size	Price /Each
SAO128	Gloves	Gunn & Wing	Large	9.30
SAP352	Gloves	Gunn & Wing	X-Large	9.60
SAO129	One-Finger Mitt	Clute & Wing	Large	9.40

## WELDERS' SOFTOUCH™ PIGSKIN TIG GLOVES

- Seamless index finger construction provides unobstructed control over small diameter welding rods and ultra light TIG torches
- Extra long cuff offers wrist and forearm protection against heat
- 4" split pigskin cuff, seamless index finger
- Clute cut pattern with straight thumb style
- Sewn with DuPont® Kevlar® thread for higher seam strength and seam flame resistance

Model No.	Size	Price /Each
610-2008M	Medium	19.80
610-2008	Large	20.10



## WELDERS' PREMIUM QUALITY FOAM LINED GLOVES

- Premium split cowhide leather construction
- Excellent abrasion resistance
- Full reinforced thumb strap extends wear life
- Cotton covered foam lining provides superior heat protection
- Weltered seams at all critical points
- Gunn cut pattern with wing thumb style
- Sewn with DuPont® Kevlar® thread for higher seam strength and seam flame resistance

Model No.	Size	Price /Each
SAN277	Large	11.55



## WELDERS' PREMIUM QUALITY GLOVES

- Premium split cowhide leather construction
- Excellent abrasion resistance
- Outside double palm and thumb extend wear life
- Thermal cotton palm lining provides added heat protection
- Weltered seams at all critical points
- Gunn cut pattern with wing thumb style
- Sewn with DuPont® Kevlar® thread for higher seam strength and seam flame resistance

Model No.	Size	Price /Each
SAN635	Large	10.10



## WELDERS' PIPELINER GLOVES

- Premium split cowhide leather exterior construction
- Full grain cowhide leather interior provides incomparable comfort
- Protective leather patch on back of left hand
- Excellent abrasion resistance
- Reinforced thumb extends wear life
- Gunn cut pattern with straight thumb style
- Sewn with DuPont® Kevlar® thread for higher seam strength and seam flame resistance

Model No.	Size	Price /Each
SAV008	Large	14.50
SEB930	X-Large	15.95





## WELDERS' COMFOFLEX™ PREMIUM QUALITY GLOVES

- Heat and flame resistant shoulder split cowhide
- Fully sock lined for added comfort
- 13 1/2" long with reinforced thumb
- Gunn cut pattern with straight thumb style
- Fully welted DuPont® Kevlar® stitched seams for higher seam strength and flame resistance



Model No.	Size	Price /Each
610-0328	Large	14.20

## WELDERS' PREMIUM COWHIDE TIG GLOVES

- Premium grain cowhide leather construction
- Unparalleled fit and dexterity with exceptional durability
- Welted seams and straight thumb for expert control
- 4" gauntlet cuff provides superior protection
- Designed for precision welding applications
- Gunn cut pattern with straight thumb style
- Sewn with DuPont® Kevlar® thread for higher seam strength and seam flame resistance



Model No.	Size	Price /Each
SDL992	Medium	12.75
SDL993	Large	12.95
SDL994	X-Large	13.45

## WELDERS' COMFOFLEX™ PREMIUM LINED GLOVES

- Flame retardant, air cushioned, sweat absorbent lining
- Provides incomparable comfort and extra insulation
- Buck tan, heat resistant side split cowhide
- Outside double palm and thumb extend wear life
- Gunn cut pattern with wing thumb style
- Sewn with DuPont® Kevlar® thread for higher seam strength and seam flame resistance



610-2000

Model No.	Description	Price /Each
610-2000	Welding Gloves	21.10
610-2178	One-Finger Mitts	21.50
610-2076	Pigskin Gloves	29.50

## WELDERS' HEAVY-DUTY GENERAL PURPOSE PREMIUM COWHIDE GLOVES

- Premium grain cowhide leather construction with split cowhide leather palm
- Unlined palm for increased comfort and dexterity
- 6" gauntlet cuff for increased protection
- Reinforced thumb extends wear life
- Gunn cut pattern with straight thumb style
- Fully welted DuPont® Kevlar® stitched seams for higher seam strength and flame resistance



Model No.	Size	Price /Each
SDL995	Medium	12.40
SDL996	Large	12.75
SDL997	X-Large	13.30

## WELDER'S COMFOFLEX® PEARL DEERSKIN GLOVES

- 14 1/2" incredibly soft, genuine North American deer hides
- Flame retardant, air cushioned, sweat absorbent lining
- Thick pliable layer of protection that easily molds to your hand for added comfort
- Gunn cut pattern with straight thumb style
- Sewn with DuPont® Kevlar® thread for higher seam strength and seam flame resistance



Model No.	Size	Price /Each
610-2850	Large	49.50

## CASCADE-TORCH WELDING GLOVES

- Cowhide gauntlet cuffs protect against welding slag
- Durahide Cow performance leather construction doesn't dry out or crack with heat exposure
- HiRoller™ fingertip design offers welders better dexterity, durability and control
- Glide-resistant leather side seam reinforcement protects from surface burns while you work
- Comfortable Keystone thumb design gives you better control
- Gunn Cut glove design reduces seam usage in the palm for heavy material handling
- Internally reinforced fingertips provide crucial heat resistance and increased wear
- For MIG and TIG welding applications
- Inner Lining: Unlined
- Leather Palm Type: DuraHide™
- Colour: Black



SGY243



Model No.	Mfg. No.	Size	Price /Each
SGY243	WS-CCD-008	Small	46.90
SGY244	WS-CCD-009	Medium	46.90
SGY245	WS-CCD-010	Large	46.90
SGY246	WS-CCD-011	X-Large	46.90
SGY247	WS-CCD-012	2X-Large	46.90

## HIGH HEAT HAND SHIELDS

- Aluminized PFR rayon reflects 95% radiant heat
- 5-ply DuPont® Kevlar® sewn and split cowhide backing for extra durability
- Leather and elastic strap system
- Sold individually



SE549

Model No.	Description	Price /Each
SE549	Premium Hand Shield	13.75

# HAND PROTECTION

## LIGHTWEIGHT POLYURETHANE PALM COATED GLOVES

- Excellent abrasion resistance
- Premium comfort and breathability
- 13-gauge seamless polyester knit provides ultimate dexterity and reduces hand fatigue
- Superior dry grip
- Knit wrist • Ultra soft polyurethane coated palm
- EN 388 Performance Levels: 4114
- EN 420 Dexterity Level: 5

**Applications:** Clean room environments, quality control, electronics assembly and general manufacturing



Model No.	Black	Size	Price /Each	Model No.	White	Size	Price /Each
SAX694	6	1.10	SA0161	6	1.10		
SAX695	7	1.10	SA0162	7	1.10		
SAX696	8	1.10	SA0163	8	1.10		
SAX697	9	1.10	SA0164	9	1.10		
SAX698	10	1.10	SA0165	10	1.10		
SAX699	11	1.10	SA0166	11	1.10		



## DMF-FREE POLYURETHANE PALM COATED GLOVES

- Lightweight gloves offer premium comfort and breathability
- Nylon liner has inherent hydrophobic properties which dry the liner quickly after getting wet
- Dimethylformamide (DMF) Free
- Gauge: 15
- Liner: Nylon
- Coating: Polyurethane
- EN 388 Performance Levels: 4131
- Lining: Unlined
- Colour: Grey
- Cuff Style: Knit

**Applications:** Clean room environments, quality control, electronics assembly and general manufacturing



Model No.	Size	Price /Each
SGI151	7	1.75
SGI152	8	1.75
SGI153	9	1.75
SGI154	10	1.75
SGI155	11	1.75



## HI-TECH ASSEMBLY PALM COATED GLOVES

- Seamless 13-gauge 100 % black nylon liner
- Abrasion, tear and small cut resistant
- Open back eliminates perspiration and offers superb user comfort
- Grey polyurethane-coated palm
- Anatomical shape facilitates movement

**Applications:** Car mechanics, handling of greasy parts, industrial assembly, precision mechanics



Model No.	Mfg. No.	Size	Price /Each
SA0085	B0500B5-06	6	3.69
SA0086	B0500B8-07	7	3.69
SA0087	B0500B1-08	8	3.69
SA0088	B0500BXL-09	9	3.69



## HYFLEX® 11-618 GLOVES

- Black polyurethane palm coated
- Ultra-light weight glove maximizing touch and precision for delicate handling operations
- Ideal for workers who need a higher level of touch and precision in dry or slightly oily applications
- Ultralight weight 18-gauge seamless liner enhances flexibility, tactility and handling efficiency
- The ultralight glove is just 0.8-mm thick in total, providing high dexterity with high abrasion resistance (Level 3)
- Silicone-free

**Applications:** Light assembly requiring high degree of precision, picking and lifting small pieces, finishing works



Model No.	Mfg. No.	Size	Price /Each
SEI717	112074	Small	4.12
SEI718	112075	Medium	4.12
SEI719	112076	Large	4.12
SEI720	112077	X-Large	4.12

## HYFLEX® 11-600/11-601 GLOVES

- Light-duty polyurethane palm coating, knit nylon liner
- Silicone-free • Seamless
- Snug fit for maximum dexterity and tactile sensitivity
- New palm dipping technology – keeps back of hands and knuckles open, reducing hand fatigue and promoting comfort and coolness
- Accepted for use in Canadian food processing facilities

**Applications:** Electronics assembly and computer assembly



Model No.	Mfg. No.	Size	Price /Each
<b>11-600 (WHITE PALM, WHITE LINER)</b>			
SAW968	1160011060	6	2.79
SAW969	1160011070	7	2.79
SAW970	1160011080	8	2.79
SAW971	1160011090	9	2.79
SAW972	1160011100	10	2.79
SAW973	1160011110	11	2.79
<b>11-601 (GREY PALM, BLACK LINER)</b>			
SAW974	107035	6	2.77
SAW975	107036	7	2.77
SAW976	107037	8	2.77
SAW977	107038	9	2.77
SAW978	110578	10	2.77



## PX130 GLOVES

- Lightweight and stretchable liner for an optimized fit and feel
- Good abrasion resistance thanks to the polyurethane coating on the palm
- Elasticated knitwrist cuff to ensure snug fit
- Excellent comfort and dexterity
- Added benefit of an increased oil grip
- EN 420 dexterity level 5 rating enables hands to operate at peak performance without ever letting comfort or dexterity slip
- Gauge: 15
- Liner: Nylon
- Unlined

**Applications:** General handling, general maintenance, printing industry, handling of small/fine parts



Model No.	Mfg. No.	Size	Price /Each
SDP581	1114396	6	2.32
SAL996	1114397	7	2.32
SAL997	1114398	8	2.32
SAL998	1114399	9	2.32
SAL999	1114400	10	2.32



## NITRILE FOAM PALM COATED GLOVES

- Ultra light nitrile foam palm coating offers maximum breathability and tactile sensitivity
- 13-gauge seamless polyester shell provides a cool comfortable fit
- Superior dexterity, comfort and wet grip reduces hand fatigue
- Excellent abrasion resistance
- Knit wrists prevents debris from entering the glove
- EN 388 Performance Levels: 4021
- EN 420 Dexterity Level: 5

**Applications:** Metal stamping, material handling, automotive assembly and small oily parts handling



Model No.	Size	Price /Each
<b>BLACK ON GREY</b>		
SBA611	6	2.05
SBA612	7	2.05
SBA613	8	2.05
SBA614	9	2.05
SBA615	10	2.05
SBA616	11	2.05

Model No.	Size	Price /Each
<b>GREY ON WHITE</b>		
SAM629	6	2.05
SAM630	7	2.05
SAM631	8	2.05
SAM632	9	2.05
SAM633	10	2.05
SAM634	11	2.05

## ZX-1 PREMIUM TOUCHSCREEN COMPATIBLE GLOVES

- Sanitized® coating inhibits bacteria, minimizes odour development, and promotes freshness
- Black foam nitrile palm coating for optimal grip in dry, wet and oily conditions
- Grey seamless nylon/spandex 15-gauge shell for optimal dexterity
- Foam nitrile coating improves abrasion resistance
- Premium comfort and breathability reduces hand fatigue
- Knit wrist prevents dirt and debris from entering the glove
- EN 388 Performance Levels: 4131
- EN 420 Dexterity Level: 5

**Applications:** Automotive, small parts handling, quality inspection, assembly and maintenance, manufacturing



Model No.	Size	Price /Each
SDP438	6	4.25
SDP439	7	4.25
SDP440	8	4.25
SDP441	9	4.25
SDP442	10	4.25
SDP443	11	4.25



## ZX-2 PREMIUM 3/4 NITRILE & NITRILE FOAM PALM COATED GLOVES

- Sanitized® coating inhibits bacteria, minimizes odour development, and promotes freshness
- Black foam nitrile palm coating for maximum grip in dry, wet and oily conditions
- Purple flat nitrile 3/4 coating to prevent liquids from permeating through the glove shell
- Grey seamless nylon/spandex 18-gauge shell for maximum dexterity
- Premium comfort and breathability reduces hand fatigue
- Knit wrist prevents dirt and debris from entering the glove
- EN 388 Performance Levels: 4121

**Applications:** Automotive, small parts handling, assembly and maintenance, manufacturing, wet/oily applications

Model No.	Size	Price /Each
SDP444	7	7.10
SDP445	8	7.10
SDP446	9	7.10
SDP447	10	7.10
SDP448	11	7.10



## COATED GLOVES

- 13-gauge seamless nylon knit provides ultimate dexterity and reduces hand fatigue
- PVC palm coating works well with glue-related applications
- Knit wrist prevents dirt and debris from entering the glove
- Premium comfort, breathability, and durability
- Applications: Assembly and maintenance, manufacturing, wood-working, and construction
- Gauge: 13
- Shell Material: Nylon
- Coating: PVC
- Coating Style: Dipped Palm
- Inner Lining: Unlined



Model No.	Size	Price /Each
SHA815	7	4.25
SHA816	8	4.25
SHA817	9	4.25
SHA818	10	4.25
SHA819	11	4.25

## HYFLEX® 11-840 GLOVES

- Lightweight, multi-purpose glove
- Enhanced dry grip and abrasion performance
- 20% more breathable than earlier formulations for cooler, drier hands
- ANSI Level 5 abrasion resistance
- Three times the abrasion performance of other lightweight knit-dipped gloves
- Form-fitting liner is snug, second-skin tailoring
- Matches the natural contours of the hand to create a more comfortable wearing experience
- Silicone free for product protection
- Coating: Nitrile foam
- Thickness: 15-Gauge
- Cuff: Knit wrist
- Colour: Gray
- Liner: Nylon/spandex

**Applications:** Assembly of small & medium parts, feeding production lines, general handling, raw material reception, screwing & unscrewing parts



Model No.	Mfg. No.	Size	Price /Each
SDM676	113036	6	5.01
SDM677	113037	7	5.01
SDM678	113038	8	5.01
SDM679	113039	9	5.01
SDM680	113040	10	5.01
SDM681	113041	11	5.01

## HYFLEX® 11-800/ 11-801 GLOVES

- Light-duty foam nitrile palm coating
- Knit nylon liner
- Excellent grip in light oil applications, oil is channelled away from the glove surface
- Highest level of comfort and protection
- Resistant to snags and abrasions
- Accepted for use in Canadian food processing facilities

**Applications:** Automotive assembly, handling small parts (especially where oil is present)



Model No.	Mfg. No.	Size	Price /Each
<b>11-800 (GREY PALM, WHITE LINER)</b>			
SAW921	103330	6	4.89
SAW922	103331	7	4.89
SAW923	103332	8	4.89
SAW924	103333	9	4.89
SAW925	103334	10	4.89
SAW926	103346	11	4.89

Model No.	Mfg. No.	Size	Price /Each
<b>11-801 (BLACK PALM, GREY LINER)</b>			
SAW962	103381	6	4.89
SAW963	103382	7	4.89
SAW964	103383	8	4.89
SAW965	103384	9	4.89
SAW966	103385	10	4.89
SAW967	103386	11	4.89





# HAND PROTECTION

## ZX-30° PREMIUM FOAM PVC COATED ACRYLIC LINED GLOVES

- Sanitized\* coating inhibits bacteria, minimizes odour development, and promotes freshness
- Foam PVC coating offers excellent breathability, dexterity and durability, while providing a superior wet or dry grip
- 15-gauge seamless nylon/spandex shell with 100% acrylic lining for superior cold protection
- Exceptional comfort and fit
- Resists abrasions, cuts and punctures
- Meets EN 511 standards for extreme cold protection maintaining flexibility in temperatures up to -50°C
- EN 511 Contact Cold Resistance Level: 2
- EN 388 Performance Levels: 3231

**Applications:** Cold/outdoor environments, fishing industry, glass/wood handling, construction, general maintenance



SGW880



SFQ726



### PALM COATED

Model No.	Size	Price /Each
SFQ726	Medium (7)	10.25
SFQ727	Large (8)	10.25
SFQ728	X-Large (9)	10.25
SFQ729	2X-Large (10)	10.25

### 3/4 COATED

Model No.	Size	Price /Each
SGW876	Medium (7)	11.00
SGW877	Large (8)	11.00
SGW878	X-Large (9)	11.00
SGW879	2X-Large (10)	11.00

### FULLY COATED

Model No.	Size	Price /Each
SGW880	Medium (7)	11.95
SGW881	Large (8)	11.95
SGW882	X-Large (9)	11.95
SGW883	2X-Large (10)	11.95

## HYFLEX® 11-818 GLOVES

- A thin yet strong glove perfect for a variety of tasks
- The HyFlex® 11-818 provides the perfect balance between comfort and protection to the wearer
- The glove contains Ansell FORTIX™ technology, a patent-pending nitrile foam coating, which offers a level 4 abrasion resistance without compromising the breathability of the glove
- The ultra-thin palm coating provides a bare hand-like feel and a high level of grip to handle small and fine parts
- Thickness: 18-gauge
- Cuff: Knit wrist
- Colour: Blue
- Liner: Nylon/spandex

**Applications:** Assembly of dry parts, feeding the lines, fine mounting of small nuts and bolts, handling of small/fine parts, mounting & dismounting parts, screwing, unscrewing, ultra-fine mechanical applications

Model No.	Mfg. No.	Size	Price /Each
SDM259	111714	7	5.67
SDM260	111715	8	5.67
SDM261	111716	9	5.67
SDM262	111717	10	5.67
SDM263	111718	11	5.67



SDM259



Model No.	Size	Price /Each
SGX782	Small	5.50
SGX783	Medium	5.50
SGX784	Large	5.50
SGX785	X-Large	5.50
SGX786	2X-Large	5.50



SGX782

## 377 GLOVES

- Thin dipped blue nitrile coated glove
- Black foam nitrile coated palm ensures excellent grip
- Elastic knit-wrist holds the glove firmly on the arm for enhanced fit
- Liquid resistant
- Launderable

**Applications:** Mechanical and automotive, constructions, machine assembly, handling oily objects, limited chemical splash and refineries



Model No.	Mfg. No.	Size	Price /Each
SEI864	377-06	Small	9.60
SEI865	377-07	Medium	9.60
SEI866	377-08	Large	9.60
SEI867	377-09	X-Large	9.60
SEI868	377-10	2X-Large	9.60

SEI864



## NITRI-FLEX LITE® NITRILE PALM COATED GLOVES

- Seamless nylon knit gloves with a textured green nitrile palm coat
- Resist cuts, snags and abrasion with non slip grip
- Snug fitting knit wrist glove is extremely flexible
- Accepted for use in Canadian food processing facilities

**Applications:** Construction, general maintenance and shipping & receiving



Model No.	Mfg. No.	Size	Price /Each
SQ136	4500S-7	Small	5.60
SQ137	4500M-8	Medium	5.60
SQ138	4500L-9	Large	5.60
SQ139	4500XL-10	X-Large	5.60

SQ136



## PREMIUM NITRILE PALM COATED GLOVES

- 15-gauge seamless nylon knit provides ultimate dexterity and reduces hand fatigue
- Superior abrasion, cut and puncture resistance
- Fluorescent green shell and green coating offers maximum visibility
- Premium comfort and breathability
- Excellent dry grip
- Durable nitrile coated palm
- Knit wrist prevents dirt and debris from entering the glove
- Accepted for use in Canadian food processing facilities
- EN 388 Performance Levels: 4121

**Applications:** Manufacturing, maintenance, small parts handling, laboratory, painting and janitorial



Model No.	Size	Price /Each
SEI851	7	2.60
SEI852	8	2.60
SEI853	9	2.60
SEI854	10	2.60
SEI855	11	2.60



SEI854

## FOAM NITRILE COATED GLOVES

- Thin, blue nitrile coating
- Foam nitrile coated palm ensures superior grip
- Elastic-knit wrist keeps glove from falling off improves fit
- Liquid-resistant and launderable
- Gauge: 15
- Shell Material: Nylon

**Applications:** Mechanical and automotive, constructions, machine assembly, handling oily objects, limited chemical splash and refineries

## LIGHTWEIGHT NITRILE COATED GLOVES

- 13-gauge seamless polyester knit provides ultimate dexterity and reduces hand fatigue
- Superior abrasion, cut and puncture resistance
- Premium comfort and breathability
- Excellent dry grip
- Durable nitrile coated palm
- Knit wrist prevents dirt and debris from entering the glove
- EN 388 Performance Levels: 4123
- EN 420 Dexterity Level: 5

**Applications:** Metal stamping, material handling, automotive assembly and small parts handling



Model No.	Size	Price /Each
SAO157	7	1.10
SAO158	8	1.10
SAO159	9	1.10
SAO160	10	1.10
SAP355	11	1.10

## BLACK POLYESTER NITRILE COATED GLOVES

- 13-gauge seamless polyester knit provides ultimate dexterity and reduces hand fatigue
- Black liner with grey palm hides the dirt and extends life
- Superior abrasion, cut and puncture resistance
- Premium comfort and breathability
- Excellent dry grip • Durable nitrile coated palm
- Knit wrist prevents dirt and debris from entering the glove
- EN 388 Performance Levels: 4123
- EN 420 Dexterity Level: 5



Model No.	Size	Price /Each
SAP931	7	1.10
SAP932	8	1.10
SAP933	9	1.10
SAP934	10	1.10
SAP935	11	1.10

## MEDIUM WEIGHT NITRILE COATED GLOVES – INTERLOCK LINING

- Interlock cotton lining
- Superior abrasion, cut and puncture resistance
- Excellent comfort and breathability
- Greater dexterity than heavyweight
- Open back coating provides a cool comfortable fit
- Knit wrist eliminates dirt and debris from entering the glove

**Applications:** Light to medium fabrication, material handling, automotive, and general maintenance



Model No.	Size	Price /Each
SAO150	7	2.30
SAO151	8	2.30
SAO152	9	2.30
SAO153	10	2.30
SAO154	11	2.30

## MEDIUM WEIGHT NITRILE COATED GLOVES – COTTON LINING

- 13-gauge seamless knitted cotton shell
- Resists abrasion, cut and punctures
- Excellent dexterity and dry grip
- Open back 3/4 coating provides a cool comfortable fit
- Knit wrist prevents dirt and debris from entering the glove

**Applications:** Metal stamping, material handling, automotive, small parts handling and general maintenance



Model No.	Size	Price /Each
SAM646	7	1.85
SAM647	8	1.85
SAM648	9	1.85
SAM649	10	1.85

## HYFLEX® 11-920 GLOVES

- Special nylon fine gauge liner
- Ansell Grip Technology™ nitrile coating on palm repels oils and other lubricants away from the surface via microscopic channels
- Increases surface contact for enhanced grip and control
- Prevents oil penetration and reduces the risk of dermatitis and liquid exposure
- Provides softness, comfort and breathability to the glove
- Ergonomic, natural fit
- Available in a wide range of sizes to protect more workers
- Accepted for use in Canadian food processing facilities

**Applications:** Engine and transmission assembly, handling machine parts free from shavings and sharp edges, handling small castings, gears and other abrasive edged parts, light metal fabrication and parts handling, light stamping in oily environments and product inspection



Model No.	Mfg. No.	Size	Price /Each
SAY772	104456	6	6.04
SAY773	104457	7	6.04
SAY774	104458	8	6.04
SAY775	104459	9	6.04
SAY776	104460	10	6.04
SAY777	104461	11	6.04

## HYFLEX® 11-900 GLOVES

- Light-duty nitrile coating on palm, white knit nylon liner
- Excellent dry grip for applications involving small to medium sized parts
- Abrasion resistance
- Oil repellency, nitrile coating prevents oil from penetrating through the glove, protecting hands from dermatitis
- Accepted for use in Canadian food processing facilities

**Applications:** Automotive assembly and metal fabrication.



Model No.	Mfg. No.	Size	Price /Each
SAW979	103347	6	5.51
SAW980	103348	7	5.51
SAW981	103349	8	5.51
SAW982	103350	9	5.51
SAW983	103351	10	5.51

# HAND PROTECTION

## HYLITE® 47-400 GLOVES

- Nitrile-coated, interlock knit-lined, medium-duty
- Outwear cotton up to 12 to 1, light leather 5 to 1 and PVC coated gloves 3 to 1
- Exceptional snag, puncture, abrasion and cut resistance
- Extra comfort
- Accepted for use in Canadian food processing facilities

**Applications:** Assembly, inspection, medium-duty handling/light fabrication, shipping & receiving and maintenance

Model No.	Mfg. No.	Size	Price /Each
SAW984	103451	7	5.55
SAW985	103452	8	5.55
SAW987	103454	9	5.55
SAW988	103455	10	5.55



SAW984

**Ansell**

## ACTIVARMR® 80-100 GLOVES

- Natural rubber latex, crinkle finish
- Soft seamless poly/cotton knit liner
- Superior wet and dry grip
- Combination of cut, abrasion and puncture resistance
- Fully-coated thumb provides added protection in this high-risk area
- Uncoated back allows air to circulate which keeps hands cooler and drier
- Ergonomically designed, unbelievable comfort
- Accepted for use in Canadian food processing facilities
- Meets ANSI/ISEA 105 Level 2, EN388 Level 2 for cut resistance

**Applications:** General maintenance, shipping and receiving, assembly, concrete and brick handling and lumber handling

**Caution:** This product contains natural rubber latex which may cause allergic reactions in some individuals

Model No.	Mfg. No.	Size	Price /Each
SAY841	103496	6	4.67
SAY842	103497	7	4.67
SAY843	103498	8	4.67
SAY844	103499	9	4.67
SAY845	103500	10	4.67

**Ansell**



SAY841

## ACTIVARMR® 97-013 HI-VIZ™ GLOVES

- Medium-duty glove with exclusive nitrile/polyurethane coating provides excellent wet/dry grip
- Techcor® Knitting Technology offers enhanced protection from cuts and abrasions without sacrificing comfort or dexterity
- Contrast vivid orange colour and retroreflective logo increases visibility and safety
- 13 gauge liner offers comfort for all day wear; ergonomically designed to reduce hand fatigue
- Silicone-free
- Meets EN388 Level 2 for cut resistance
- Cuff style: Knit wrist • Liner: Nylon
- Unlined

**Applications:** Handling abrasive or rugged materials, maintenance/repair, carpentry, assembly, heavy equipment operation, digging/trenchwork, general material handling

Model No.	Mfg. No.	Size	Price /Each
SDR731	114775	7	13.20
SDR732	114776	8	13.20
SDR733	114777	9	13.20
SDR734	114778	10	13.20
SDR735	114779	11	13.20



SDR731

**Ansell**

## 341 GLOVES

- High levels of flexibility and softness
- Engineered waterproof latex coating to palm and fingertips
- Elasticated wrist provides a secure and comfortable fit
- Breathable 13-gauge polyester/cotton liner
- Excellent dexterity and tactility
- Ergonomic design that replicates the natural curvature of a human hand helps to reduce fatigue
- Seamless for optimum comfort
- Antibacterial and anti-odour treatment
- Liner: Nylon
- Unlined

**Applications:** Construction material, handling, general handling, light assembly, maintenance

Model No.	Mfg. No.	Size	Price /Each
SDP567	341S-06	Small (6)	6.08
SDP568	341M-07	Medium (7)	6.08
SDP569	341L-08	Large (8)	6.08
SDP570	341XL-09	X-Large (9)	6.08

**SHOWA**



SDP567

## ATLAS FIT® 300 COATED GLOVES

- Durable rubber coating
- Cotton/polyester lining provides extremely comfortable fit
- Rough textured gripping
- An elastic knit-wrist secures the glove above the wrist for comfort and prevents debris from entering the glove
- Launderable

**Applications:** Construction, landscaping, carpentry, floor tiling, maintenance, masonry, garbage collection, highway work, roofing, shipping and receiving

**SHOWA**

Model No.	Mfg. No.	Size	Price /Each
<b>BLUE</b>			
SAO815	300-07	Small	5.36
SAO816	300-08	Medium	5.36
SAO817	300-09	Large	5.36
SAO818	300-10	X-Large	5.36
<b>GREEN</b>			
SAO819	310GXS-06	X-Small	5.36
SAO820	310GS-07	Small	5.36
SAI304	310GM-08	Medium	5.36
SAI305	310GL-09	Large	5.36
SAO823	310GXL-10	X-Large	5.36



SAO815



SAO819

## 306 GLOVES

- Full foam latex coating coupled with an additional latex grip coating to the palm and fingertips
- Seamless 13-gauge nylon/polyester knitted liner
- Water repellent
- Breathable coating technology
- Long lasting grip performance in wet and dry conditions
- Aerated foam latex provides cushioning from minor impacts
- Soft, comfortable fit
- Anatomical hand shape design helps prevent hand fatigue
- Liner: Nylon
- Unlined

**Applications:** Banksmen, handling construction materials, handling insulation, labouring, outdoor wet work, warehousing

Model No.	Mfg. No.	Size	Price /Each
SDP571	306S-06	Small (6)	9.52
SDP572	306M-07	Medium (7)	9.52
SDP573	306L-08	Large (8)	9.52
SDP574	306XL-09	X-Large (9)	9.52
SDP575	306XXL-10	2X-Large (10)	9.52

**SHOWA**



SDP571



## NATURAL RUBBER LATEX COATED GLOVES

- Natural rubber latex palm coating
- 10-gauge seamless knitted poly/cotton shell
- Resists abrasion, cuts and punctures
- Exceptional comfort and fit
- Palm coating provides a cool comfortable fit
- Textured coating provides superior wet and dry grip
- Knit wrist prevents debris from entering the glove
- EN 388 Performance Levels: 2144
- EN 420 Dexterity Level: 5

**Applications:** Glass handling, construction, wood handling, masonry and general maintenance

SAL258

Model No.	Size	Price /Each
SEB865	7	1.90
SAL255	8	1.90
SAL256	9	1.90
SAL257	10	1.90
SAL258	11	1.90

**ZENITH**  
Safety Products



## NATURAL RUBBER LATEX PALM COATED CRINKLE FINISH GLOVES

- High density 100% cotton jersey lining
- Exceptional cut and abrasion resistance
- Superior comfort and flexibility
- Crinkle finish coating provides superior grip
- Safety cuff provides added protection

**Applications:** Glass handling, sheet metal handling and general handling of any sharp-edged materials

SAN435



Model No.	Size	Price /Each
SAN435	10	4.25

**ZENITH**  
Safety Products

## NATURAL RUBBER LATEX PALM COATED FLEECE LINED GLOVES

- Natural rubber latex palm coating
- 10-gauge seamless knitted poly/cotton shell
- Resists abrasion, cuts and punctures
- Exceptional comfort and fit
- Textured coating provides superior wet and dry grip
- Palm coated
- Knit wrist
- EN 388 Performance Levels: 2144
- EN 420 Dexterity Level: 5

**Applications:** Glass handling, construction, wood handling, masonry and general maintenance

**ZENITH**  
Safety Products



SGV157

SAN434



## NATURAL RUBBER LATEX COATED GLOVES

- Natural rubber latex palm coating
- 13-gauge seamless knitted polyester shell provides a comfortable fit
- Resists abrasion, cuts and punctures
- Crinkle finish coating provides superior wet and dry grip
- Knit wrist prevents debris from entering the glove
- EN 388 Performance Levels: 2121

**Applications:** Glass handling, construction, wood handling, automotive, masonry and general maintenance/manufacturing

SFM541

Model No.	Size	Price /Each
SGG331	6	1.65
SFM541	7	1.65
SFM542	8	1.65
SFM543	9	1.65
SFM544	10	1.65

**ZENITH**  
Safety Products



Model No.	Size	Price /Each
LIGHT LINING		
SAN431	8	2.25
SAN432	9	2.25
SAN433	10	2.25
SAN434	11	2.25

Model No.	Size	Price /Each
PREMIUM LINING		
SGV157	8	3.55
SGV158	9	3.55
SGV159	10	3.55
SGV160	11	3.55

## HIGH VISIBILITY RUBBER COATED ACRYLIC-LINED GLOVES

- 100% acrylic thermal lining offers superior cold protection
- 7-gauge seamless terry knitted and brushed liner
- Resists abrasions, cuts and punctures
- Exceptional comfort and fit
- Natural rubber latex palm coating
- Uncoated back permits breathability and limits perspiration
- Fluorescent yellow shell and blue coating offer maximum visibility
- Crinkle finish coating provides superior wet and dry grip
- EN 388 Performance Levels: 3143
- EN 511 Contact Cold Resistance Level: 1

**Applications:** Fishing industry, cold/outdoor environments, glass/wood handling masonry and general maintenance

SEC799



Model No.	Size	Price /Each
SEC797	7	3.58
SEC798	8	3.58
SEC799	9	3.58
SEC800	10	3.58
SEC801	11	3.58

**ZENITH**  
Safety Products

## POWERFLEX® T° HI-VIZ YELLOW™ 80-400

- Natural rubber latex-coated acrylic thermal liner
- Excellent insulation for cold environment
- Strong combination of abrasion, liquid repellency and dry grip
- Superior flexibility and dexterity
- Uncoated back allows for air circulation to keep hands drier
- Ergonomically designed for unmatched fit and comfort
- Palm-coated crinkle finish
- Accepted for use in Canadian food processing facilities

**Applications:** Fishing industry, cold storage, winter transportation, unheated warehouses, and field work, freight handling.

SEA278



**Ansell**

Model No.	Mfg. No.	Size	Price /Each
SEA278	103513	7	8.38
SEA279	103510	8	8.38
SEA280	103511	9	8.38
SEA281	103512	10	8.38
SEA282	103514	11	8.38

# HAND PROTECTION

## HEAVYWEIGHT NITRILE COATED SAFETY CUFF GLOVES

- High density 100% cotton jersey lining
- Superior abrasion, cut and puncture resistance
- Exceptional durability, grip and flexibility
- Safety cuff
- Full coating for maximum protection
- Palm coating provides a cool comfortable fit
- EN 388 Performance Levels: 4232

**Applications:** Rough industrial applications, sheet metal handling, fabrication workshops and automotive



Model No.	Size	Price /Each
<b>FULLY COATED</b>		
SAN445	10	3.40
SAN446	11	3.40
<b>PALM COATED</b>		
SAN447	10	3.20
SAN448	11	3.20



## HEAVYWEIGHT NITRILE FULLY COATED KNIT WRIST GLOVES

- High density 100% cotton jersey lining
- Superior abrasion, cut and puncture resistance
- Exceptional durability, grip and flexibility
- Knit wrist prevents debris from entering the glove
- EN 388 Performance Levels: 4232

**Applications:** Rough industrial applications, sheet metal handling, fabrication workshops and automotive



Model No.	Size	Price /Each
SAN441	8	2.95
SAN442	9	2.95
SAN443	10	2.95
SAN444	11	2.95

## HYCRON® 27-805 GLOVES

- Heavy-duty nitrile coated
- Outwears standard heavy-duty leather palm gloves by 3 to 1
- Soft jersey knitting eliminates seams from the working areas for greater comfort
- Excellent dry grip and superior service when handling rough, abrasive materials
- Excellent resistance to snags, puncture, abrasions, cuts, grease and oils
- Fully coated, 2 1/2" safety cuff
- Accepted for use in Canadian food processing facilities

**Applications:** Heavy-duty handling of castings, cores and fabricated metal, production handling of fabricated building materials (concrete block, brick, tile, lumber, drywall plywood)



Model No.	Mfg. No.	Size	Price /Each
SAY787	103478	10	6.46

## VINYL IMPREGNATED GLOVES

- Stretch fit provides excellent dexterity
  - Abrasion and water resistance
  - Rough surface for a superior grip
  - Colour: Red
- Applications:** Assembly work, bottling plants, warehousing, packaging, maintenance



Model No.	Description	Price /Each
SEF065	Ladies	2.10
SEF066	Men's	2.10

## ATLAS THERMA FIT® 451 COATED GLOVES

- Crinkle finish natural rubber palm coating
- Warm fleece lined shell with a knit wrist
- Exceptional warmth as well as a snug fit for excellent dexterity
- Improved grip for wet and dry conditions

**Applications:** Sheet metal, metal stamping as well as glass manufacturers and glaziers, agricultural and general assembly applications



Model No.	Mfg. No.	Size	Price /Each
SAJ985	451S-07	Small	7.04
SAJ986	451M-08	Medium	7.04
SAJ987	451L-09	Large	7.04
SAJ988	451XL-10	X-Large	7.04

## THE KNIT PICKER KPG® VINYL GLOVES

- Lightweight, breathable vinyl coating and textured finish for sure grip
- 100% cotton seam free knit liner
- Outwears cotton many times on straight abrasion
- Machine washable

**Applications:** Furniture manufacturing, automotive subassembly, general maintenance, inspection, packaging, shipping, receiving, light fabrication and general assembly



Model No.	Mfg. No.	Size	Price /Each
<b>SLIP-ON</b>			
SC414	960S-08	Small	7.32
SC415	960M-09	Medium	7.32
SA600	960L-10	Large	7.32
<b>KNIT WRIST</b>			
SC416	961S-08	Small	7.32
SC417	961M-09	Medium	7.32
SC418	961L-10	Large	7.32

**NOTE:** Cut-resistant gloves are extremely cut-resistant but not cut-proof. Do not subject to high-speed or highly serrated blades. Always disconnect power before cleaning or removing slicer blades.

## HPPE POLYURETHANE-COATED GLOVES

- Stretchable seamless HPPE liner
- HPPE (high performance polyethylene) liner is an extremely strong fibre
- Breathable polyurethane palm coating
- Excellent cut, abrasion and tear resistance
- Elastic knit wrist
- Wrinkle finish provides a superior grip
- Cut Resistance: EN 388 Level 3
- EN 388 Performance Levels: 4342
- EN 420 Dexterity Level: 5
- Accepted for use in Canadian food processing facilities

Model No.	Size	Price /Each
SFV077	7	4.60
SFV078	8	4.60
SFV079	9	4.60
SFV080	10	4.60
SFV081	11	4.60



## HPPE POLYURETHANE-COATED GLOVES

- Stretchable seamless HPPE liner
- HPPE (high performance polyethylene) liner is an extremely strong fibre
- Breathable polyurethane palm coating
- Superior cut, abrasion, and tear resistance
- Elastic knit wrist
- Provides a superior grip
- Cut resistance: ANSI/ISEA 105 Level 4/EN 388 Level 5
- EN 388 Performance Levels: 4542
- Accepted for use in Canadian food processing facilities

Model No.	Size	Price /Each
SFU948	6	4.70
SEF166	7	4.70
SEF167	8	4.70
SEF168	9	4.70
SEF169	10	4.70
SEF170	11	4.70



## COATED GLOVES

- 18G HPPE liner provides the highest level of dexterity and comfort
- HPPE (high performance polyethylene) liner is an extremely strong fibre
- Breathable polyurethane palm coating
- Excellent cut, abrasion and tear resistance
- Elastic knit wrist
- Provides a superior dry grip
- Gauge: 18
- Cut Resistance: ASTM ANSI Level A2, EN 388 Level B
- EN 388 Performance Levels: 3X41B

Model No.	Size	Price /Each
SGW790	Small	6.75
SGW791	Medium	6.75
SGW792	Large	6.75
SGW793	X-Large	6.75



## TOUCHSCREEN COMPATIBLE CUT-RESISTANT GLOVES

- Lightweight for superior dexterity and mobility
- Nitrile palm coating provides improved grip
- Palm construction masks dirt and grime for longer wear
- Gauge: 18
- Shell Material: HPPE, Nylon, Spandex
- Cut Resistance: ASTM ANSI Level A5
- Colour: Green with Black Coating
- Touchscreen compatible

Model No.	Size	Price /Each
SGX787	Small	10.35
SGX788	Medium	10.35
SGX789	Large	10.35
SGX790	X-Large	10.35
SGX791	2X-Large	10.35



## ACTIVARMR® 80-813 GLOVES

- Combines high levels of flame resistance and cut protection
- ARC flash-hazard category 2, helps protect workers against electrical hazards
- Special, soft foam coating ensures a secure grip in wet, oily and dry environments
- Ergonomic design provides superior comfort, dexterity and flexibility
- Meets EN407 Level 4 resistance to flammability
- Meets ANSI/ISEA 105 Level 4, EN388 Level 5 for cut resistance

**Applications:** Equipment assembly, facility & machinery maintenance, heavy duty metal handling, heavy equipment maintenance

## Ansell

Model No.	Mfg. No.	Size	Price /Each
SEB814	103535	6	21.40
SEB815	103536	7	21.40
SEB816	103537	8	21.40
SEB817	103538	9	21.40
SEB818	103539	10	21.40
SEB819	103540	11	21.40



## HYFLEX® 11-550 GLOVES

- Excellent comfort and dexterity
- Outstanding protection from nuisance nicks and abrasion
- Soil-masking black palm coating for extended product use
- For dry to light oil conditions with excellent abrasion resistance
- Gauge: 15
- Coating: Nitrile
- Cut Resistant: ASTM ANSI Level A2

## Ansell

Model No.	Mfg. No.	Size	Price /Each
SG0479	11550060	6	8.14
SG0480	11550070	7	8.14
SG0481	11550080	8	8.14
SG0482	11550090	9	8.14
SG0483	11550100	10	8.14
SG0484	11550110	11	8.14





# HAND PROTECTION

## FOAM NITRILE COATED ARAMID GLOVES

- Stretchable seamless 13-gauge Aramid liner
- Foam nitrile palm coating provides optimal grip in light oil and wet conditions
- Excellent cut, abrasion and tear resistance
- Elastic knit wrist
- Meets EN388 Level 5 for cut resistance
- EN 388 Performance Levels: 3542

**Applications:** Component assembly, waste handling, automotive and metal handling

Model No.	Size	Price /Each
SEC137	7	6.55
SAP923	8	6.55
SAP924	9	6.55
SAP925	10	6.55
SAP926	11	6.55
SEC138	12	6.55



## DMF-FREE COATED GLOVES

- Lightweight gloves offer premium comfort and breathability
- Nylon liner has inherent hydrophobic properties which dry the liner quickly after getting wet
- Dimethylformamide (DMF) Free
- Applications: Clean room environments, quality control, electronics assembly and general manufacturing
- Gauge: 15
- Shell Material: Nylon
- Coating: Polyurethane
- Coating Style: Dipped Palm
- Inner Lining: Unlined
- EN 388 Performance Levels: 4131
- Colour: Grey
- Cuff Style: Knit

Model No.	Size	Price /Each
SGI151	Small, 7	1.75
SGI152	Medium, 8	1.75
SGI153	Large, 9	1.75
SGI154	X-Large, 10	1.75
SGI155	2X-Large, 11	1.75



## LATEX COATED TWARON® GLOVES

- Natural rubber latex palm coating
- Seamless 10 gauge Twaron® liner
- Excellent cut, tear and puncture resistance
- Elastic knit wrist
- Wrinkle finish provides a superior grip
- Meets EN388 Level 4 for cut resistance
- EN 388 Performance Levels: 2434

**Applications:** Material handling, automotive, glass handling and waste handling

Model No.	Size	Price /Each
SAP927	8	7.40
SAP928	9	7.40
SAP929	10	7.40
SAP930	11	7.40



## S-TEX 376 GLOVES

- 3/4 coated nitrile with an additional coating of foam nitrile on the palm and fingertips
- Seamless 13 gauge Hagane Coil® knitted liner
- Protects from oils, grease and abrasion
- Long lasting grip performance in wet and oily conditions
- Manufactured using an ergonomically designed hand mold that replicates the natural curvature of the human hand
- Wrist protection
- Cuff: Knit
- Meets ANSI/ISEA 105 Level 4, EN388 Level 4 for cut resistance

**Industries:** Automotive, construction, manufacturing, steel and metals



Model No.	Mfg. No.	Size	Price /Each
SDL507	S-TEX376S-06	Small	16.60
SDL508	S-TEX376M-07	Medium	16.60
SDL509	S-TEX376L-08	Large	16.60
SDL510	S-TEX376XL-09	X-Large	16.60



## ATLAS® GRIP KV300 GLOVES

- Offers outstanding dexterity, greater comfort with the added benefit of an ergonomic design
- Wrinkle finish flat dipped rubber, with a knit wrist and a 100% Kevlar® Aramid shell
- Cut-resistant glove is also breathable
- Colour: Blue
- Meets ANSI/ISEA 105 level 3 for cut resistance, EN388 level 4 for cut resistance

Model No.	Mfg. No.	Size	Price /Each
SEC412	KV300-7	7	15.10
SEC413	KV300-8	8	15.10
SEC414	KV300-9	9	15.10
SEC415	KV300-10	10	15.10



## HYFLEX® 11-501 GLOVES

- Intercept Technology® yarn liner developed by Ansell and Dupont™
- Lightweight fit and feel with superior cut resistance
- Outstanding dexterity
- Superior oil grip, tactile sensitivity, dexterity and comfort
- Cut prevention improves productivity and profitability
- Teal foam nitrile palm coating
- Accepted for use in Canadian food processing facilities
- Meets ANSI/ISEA 105 Level 4, EN388 Level 4 for cut resistance

**Applications:** Automotive assembly, sheet metal assembly, handling sharp small parts, handling glass

Model No.	Mfg. No.	Size	Price /Each
SAW951	103364	6	23.30
SAW952	103365	7	23.30
SAW953	103366	8	23.30
SAW954	103367	9	23.30
SAW955	103368	10	23.30



## HYFLEX® 11-735 GLOVES

- Palm coating improves grip and extends glove life in abrasive conditions
- Provides breathability for back-of-hand comfort
- INTERCEPT™ Technology cut resistance yarn exceeds industry standards
- Proprietary technology offers increased comfort and dexterity
- ANSI Cut Level 4/ANSI Abrasion Level 6 protection
- Gauge: 10
- Coating: Polyurethane
- Black colour coating hides dirt on gloves

Model No.	Mfg. No.	Size	Price /Each
SFV107	11735060	6	14.50
SFV108	11735070	7	14.50
SFV109	11735080	8	14.50
SFV110	11735090	9	14.50
SFV111	11735100	10	14.50
SFV112	11735110	11	14.50



## HPPE FLAT NITRILE-COATED GLOVES

- Stretchable seamless liner
- HPPE (high performance polyethylene) liner is an extremely strong fibre
- Breathable nitrile palm coating
- Excellent abrasion and tear resistance
- Elastic knit wrist
- Provides a superior grip
- Meets EN388 Level 3 for cut resistance
- EN 388 Performance Levels: 4342
- Accepted for use in Canadian Food Processing Facilities



Model No.	Size	Price /Each
SEB090	7	4.40
SEB091	8	4.40
SEB092	9	4.40

Model No.	Size	Price /Each
SEB093	10	4.40
SEB094	11	4.40

## HPPE FLAT NITRILE-COATED GLOVES

- Stretchable, seamless liner
- HPPE (High-Performance Polyethylene) liner is an extremely strong fibre
- Breathable nitrile palm-coating
- Excellent abrasion, cut, puncture and tear resistance
- Elastic knit wrist
- Provides a superior grip
- Gauge: 13
- EN 388 Performance Levels: 4544
- Cut Resistance: EN 388 Level 5, ANSI/ISEA 105 Level 4



Model No.	Size	Price /Each
SGD506	5	4.70
SGD507	6	4.70
SGD563	7	4.70
SGD564	8	4.70

Model No.	Size	Price /Each
SGD565	9	4.70
SGD566	10	4.70
SGD567	11	4.70

## HPPE FOAM NITRILE COATED ACRYLIC LINED GLOVES

- Foam nitrile palm coating provides excellent grip in light oil, greasy and wet conditions
- Acrylic lining provides superior warmth and comfort in cold weather applications
- Stretchable seamless HPPE liner
- Gauge: 13
- Cut Resistance: ASTM ANSI LEVEL A4
- EN 511 Contact Cold Resistance Level: 2



Model No.	Size	Price /Each
SGF948	Small (7)	8.75
SGF949	Medium (8)	8.75
SGF950	Large (9)	8.75

Model No.	Size	Price /Each
SGF951	X-Large (10)	8.75
SGF952	2X-Large (11)	8.75

## HPPE FOAM NITRILE-COATED GLOVES

- Stretchable seamless liner
- HPPE (high performance polyethylene) liner is an extremely strong fibre
- Breathable nitrile palm coating
- Excellent abrasion and tear resistance
- Elastic knit wrist
- Provides a superior grip
- Meets EN388 Level 3 for cut resistance
- EN 388 Performance Levels: 4342
- Accepted for use in Canadian Food Processing Facilities



Model No.	Size	Price /Each
SFU852	7	5.20
SFU853	8	5.20
SFU854	9	5.20

Model No.	Size	Price /Each
SFU855	10	5.20
SFU856	11	5.20

## ARAMID FOAM NITRILE-COATED GLOVES

- 13-gauge stretchable seamless Aramid liner
- Breathable foam nitrile palm coating
- Elastic knit wrist
- Superior grip on oil and wet applications
- Cut Resistance: ASTM ANSI LEVEL A6
- ASTM ANSI Abrasion-Resistance Level: 4
- ASTM ANSI Puncture-Resistance Level: 4



Model No.	Size	Price /Each
SGH411	X-Small (6)	12.30
SGF145	Small (7)	12.30
SGF146	Medium (8)	12.30

Model No.	Size	Price /Each
SGF147	Large (9)	12.30
SGF148	X-Large (10)	12.30
SGF149	2X-Large (11)	12.30

## SALT & PEPPER KNIT WITH BLACK POLYURETHANE PALM GLOVES

- Breathable polyurethane palm coating
- Floats on water
- High energy absorption and low elongation
- Anatomically formed for added comfort
- Resistant to abrasion, moisture, UV rays, mildew, chemicals and detergents
- Cut resistance unaffected by washing
- Colour: Black on salt & pepper
- Meets EN388 Level 3 for cut resistance



Model No.	Mfg. No.	Size	Price /Each
SAN298	Y9248-7S&P	7	10.50
SAN299	Y9248-8S&P	8	10.50

Model No.	Mfg. No.	Size	Price /Each
SAN300	Y9248-9S&P	9	10.50
SAN301	Y9248-10S&P	10	10.50

## 257 GLOVES

- Exceptional performance against cuts and lacerations due to superior blend of aramid and stainless steel
- Foam nitrile coating protects palm and fingers from abrasions, snags and punctures, while offering optimum grip in both dry & oily applications
- Plated-knit liner avoids scratchy fibres touching the skin, ensuring a comfortable glove for long lasting wear
- Excellent dexterity thanks to flexible properties of spandex
- Lightweight, breathable liner with open back design reduces sweat and keeps hands dry
- Ergonomically designed to replicate the hand's natural curves
- Launderable for re-use, leads to cost efficiency and less waste
- Recommended for construction, DIY, glass, manufacturing and warehousing & distribution industries
- Gauge: 13
- Cut Resistance: EN 388 Level F, ANSI/ISEA 105 Level 7



Model No.	Mfg. No.	Size	Price /Each
SG0872	2575-06	Small, 6	15.90
SG0873	257M-07	Medium, 7	15.90
SG0874	257L-08	Large, 8	15.90

Model No.	Mfg. No.	Size	Price /Each
SG0875	257XL-09	X-Large, 9	15.90
SG0876	257XXL-10	2X-Large, 10	15.90

## HY-FLEX® 11-518 GLOVES

- Blue polyurethane palm coating
- New Dyneema® Diamond Technology HPPE yarn offers an unmatched combination of cut protection, comfort and dexterity in an 18-gauge glove
- Soft, sheer Dyneema® Diamond fiber breathes to keep hands cool and dry and moves freely with the motion of the hand for a more comfortable fit
- Polyurethane coating provides a sure grip in light oil and dry applications and excellent resistance to abrasion
- The ultralight fabric and tailored fit of the 11-518 create a barehand-like sensation of contact when performing tasks that demand high tactility
- ANSI level 2 cut protection, EN388 level 3 for cut resistance

**Applications:** Handling/Assembly of small or ultra-fine dry sharp parts, packaging areas with risk of cut, wiring



Model No.	Mfg. No.	Size	Price /Each
SEI847	111708	Small	13.70
SEI848	111709	Medium	13.70

Model No.	Mfg. No.	Size	Price /Each
SEI849	111710	Large	13.70
SEI850	111711	X-Large	13.70

# HAND PROTECTION

## HYFLEX® 11-724 GLOVES

- The palm-dipped polyurethane coating provides enhanced grip in light oil environments for secure handling
- Coating hides dirt in environments with dirt exposure
- Resilient coating resists abrasions and extends glove life
- Lightweight liner is soft and cool on the skin for all-day comfort
- Gauge: 13
- Shell Material: Intercept™
- Cut Resistance: ANSI/ISEA 105 Level 2
- ANSI Abrasion Resistance Level: 6

**Ansell**



Model No.	Mfg. No.	Size	Price /Each
SGH325	11724070	7	10.10
SGH326	11724080	8	10.10
SGH327	11724090	9	10.10

Model No.	Mfg. No.	Size	Price /Each
SGH328	11724100	10	10.10
SGH329	11724110	11	10.10

## HYFLEX® 11-727 GLOVES

- An ultralight fabric and tailored-to-hand fit creates the sensation of bare-hand comfort
- Soft, ultra light-duty, seamless liner offers enhanced flexibility and breathes to keep hands cool and dry
- Excellent fingertip sensitivity with superior comfort
- EN Level 4 abrasion protection for extended glove life
- Gauge: 15
- Coating: Polyurethane
- Cut Resistant: ASTM ANSI Level A2/EN 388 Level 3

**Ansell**



Model No.	Mfg. No.	Size	Price /Each
SGR224	11727060	6	13.10
SGR225	11727070	7	13.10
SGR226	11727080	8	13.10

Model No.	Mfg. No.	Size	Price /Each
SGR227	11727090	9	13.10
SGR228	11727100	10	13.10
SGR229	11727110	11	13.10

## HYFLEX® 11-561 GLOVES

- The Intercept™ yarn provides high cut protection while providing dexterity and comfort in dry to light oil conditions
- Palm coated
- The thin coating uses Fortix technology which provides not only extra durability but also a fit that is more comfortable and breathable
- Silicone free
- The Oeko-Tex certification guarantees that the glove does not contain any harmful substances such as DMF and other chemicals
- Fibreglass-free
- Reinforced thumb crotch
- Gauge: 15
- Cut Resistance: ASTM ANSI Level A3, EN 388 Level C
- Coating: Nitrile
- Abrasion Resistance Rating: EN 388 Level 4 & ANSI Level 4
- Tearing Strength Rating: EN 388 Level 4
- Puncture Resistance Rating: EN 388 Level 2

**Ansell**



Model No.	Mfg. No.	Size	Price /Each
SGX533	11-561-5	5	13.00
SGX534	11-561-6	6	13.00
SGX535	11-561-7	7	13.00
SGX536	11-561-8	8	13.00

Model No.	Mfg. No.	Size	Price /Each
SGX537	11-561-9	9	13.00
SGX538	11-561-10	10	13.00
SGX539	11-561-11	11	13.00
SGX540	11-561-12	12	13.00

## HYFLEX® 11-731 GLOVES

- Combination of ultra lightweight comfort and cut protection
- Light duty 18 gauge seamless liner provides enhanced flexibility and tactility
- Dirt-masking coating colour hides dirt in environments with dirt exposure
- INTERCEPT™ Technology cut resistance yarn exceeds industry standards
- Proprietary technology offers increased comfort and dexterity
- Meets EN388 Level 4 for cut resistance

**Ansell**



Model No.	Mfg. No.	Size	Price /Each
SGB961	11731060	6	12.60
SGB962	11731070	7	12.60
SGB963	11731080	8	12.60

Model No.	Mfg. No.	Size	Price /Each
SGB964	11731090	9	12.60
SGB965	11731100	10	12.60
SGB966	11731110	11	12.60

## HYFLEX® 11-757 GLOVES

- 7x more cut resistant\* for unmatched protection
- Ultra-thin ANSI cut level A7 / ISO cut level F touchscreen compatible glove for enhanced productivity
- Ultra-light design provides unmatched dexterity for handling and assembly of very sharp parts
- Unique combination of ultra-lightweight comfort and extreme cut protection
- Gauge: 18
- Cut Resistance: ASTM ANSI Level A7
- Coating: Polyurethane
- Coating Style: Dotted Palm
- Abrasion Resistance Rating: ANSI Level 3

**Ansell**



Model No.	Mfg. No.	Size	Price /Each
SGZ889	11757060	6	17.30
SGZ890	11757070	7	17.30
SGZ891	11757080	8	17.30

Model No.	Mfg. No.	Size	Price /Each
SGZ892	11757090	9	17.30
SGZ893	11757100	10	17.30
SGZ894	11757110	11	17.30

## 4561 GLOVES

- Highly abrasion-resistant
- Breathable liner keeps hands dry and comfortable
- Zorb-IT™ palm finish absorbs oil to improve grip in oily environments
- Gauge: 15
- Liner: Kevlar®
- Coating: Foam Nitrile
- Cut Resistance: ASTM ANSI Level A4

**SHOWA**



Model No.	Mfg. No.	Size	Price /Each
SGF893	4561S-06	6	11.40
SGF894	4561M-07	7	11.40
SGF895	4561L-08	8	11.40

Model No.	Mfg. No.	Size	Price /Each
SGF896	4561XL-09	9	11.40
SGF897	4561XXL-10	10	11.40

## HYFLEX® 11-751 GLOVES

- INTERCEPT Technology™ delivers excellent cut performance
- Increased abrasion resistance and durability for prolonged use and wear
- Lightweight, flexible liner provides enhanced comfort in a dirt-masking design
- Bare hand-like dexterity, tactility, flexibility
- Durable, high tactility coating
- Meets ANSI/ISEA 105 Level 5 for cut resistance

**Ansell**



Model No.	Mfg. No.	Size	Price /Each
SFW192	11751060	6	14.50
SFW193	11751070	7	14.50
SFW194	11751080	8	14.50

Model No.	Mfg. No.	Size	Price /Each
SFW195	11751090	9	14.50
SFW196	11751100	10	14.50
SFW197	11751110	11	14.50

## HYFLEX® 11-755 GLOVES

- ANSI A5/ISO E cut protection levels provide 4x greater defense from lacerations
- Ultralight and hand-fitted design for all-day comfort and dexterity
- Touchscreen compatible with tactile sensitivity for optimized productivity (versus standard ANSI A2/ISO B-rated gloves)
- Features Intercept™ Cut Resistance Technology yarn
- Dermatest®-approved for skin-friendliness and cleanliness
- Ideal for automotive, metal fabrication, and machinery and equipment industries
- Gauge: 18
- Shell Material: HPPE, Spandex, Polyester, Tungsten
- Cut Resistance: ASTM ANSI Level A5, EN 388 Level E
- Coating: Polyurethane
- Coating Style: Dipped Palm
- Abrasion Resistance Rating: EN 388 Level 3 & ANSI Level 4
- Tearing Strength Rating: EN 388 Level 4
- Puncture Resistance Rating: EN 388 Level 1
- Additional Certification(s): EN 420:2003 + A1:2009

**Ansell**



Model No.	Mfg. No.	Size	Price /Each
SGX717	11755060	6	16.50
SGX718	11755070	7	16.50
SGX719	11755080	8	16.50
SGX720	11755090	9	16.50

Model No.	Mfg. No.	Size	Price /Each
SGX721	11755100	10	16.50
SGX722	11755110	11	16.50
SGX723	11755120	12	16.50



## KEVLAR® STRING KNIT GLOVES

- 100% Kevlar®, 7 gauge string knit glove
- Offers cut protection and corrosion resistance while providing seamless comfort, dexterity and breathability
- Ambidextrous design extends wear life and improves savings
- Meets ASTM ANSI Level A2, EN388 level 3 for cut resistance
- Applications: Metal, automotive, glass handling and handling of sharp objects

Model No.	Size	Price /Each
SFP792	7	9.15
SFP793	8	9.15
SFP794	9	9.15
SFP795	10	9.15



## KEVLAR® STRING KNIT GLOVES WITH SINGLE SIDED PVC DOTS

- 100% Kevlar®, 7 gauge string knit glove with PVC dots
- Offers cut protection and corrosion resistance while providing seamless comfort, dexterity and breathability
- Ambidextrous design extends wear life and improves savings
- PVC dots provide excellent grip and abrasion resistance
- Meets ASTM ANSI Level A2, EN388 level 3 for cut resistance
- Applications: Metal, automotive, glass handling and handling of sharp objects

Single Dot Model No.	Size	Price /Each
SFP796	7	9.35
SFP797	8	9.35
SFP798	9	9.35
SFP799	10	9.35



## KEVLAR® STRING KNIT GLOVES WITH DOUBLE SIDED PVC DOTS

- 100% Kevlar®, 7 gauge string knit glove with PVC dots
- Offers cut protection and corrosion resistance while providing seamless comfort, dexterity and breathability
- Ambidextrous design extends wear life and improves savings
- PVC dots provide excellent grip and abrasion resistance
- Meets EN388 Level 3 for cut resistance
- Applications: Metal, automotive, glass handling and handling of sharp objects

Model No.	Size	Price /Each
SFP800	7	9.55
SFP801	8	9.55

Model No.	Size	Price /Each
SFP802	9	9.55
SFP803	10	9.55



## T-FLEX® PLUS SEAMLESS GLOVES

- Dyneema®-Spectra®, engineered fibre
- Coated glove offers superior dexterity and grip
- 13-gauge seamless knit glove for high performance, cut resistant technology
- Thermax® lined knit for warmth
- Stretch feel and breathable comfort
- Ambidextrous
- Fully launderable
- Accepted for use in Canadian food processing facilities
- Meets ANSI/ISEA 105 level 4 for cut resistance

**Applications:** Sheet metal, food processing, meat and poultry industry

Model No.	Mfg. No.	Size	Price /Each
SAP622	8113-06	X-Small	13.30
SAP623	8113-07	Small	13.30
SAP624	8113-08	Medium	13.30
SAP625	8113-09	Large	13.30
SAP626	8113-10	X-Large	13.30

SAP622



SAL093



Model No.	Mfg. No.	Size	Price /Each
<b>DOTTED STYLE</b>			
SAL093	8113C-06	X-Small	15.60
SAL094	8113C-07	Small	15.60
SAL095	8113C-08	Medium	15.60
SAL096	8113C-09	Large	15.60
SAL097	8113C-10	X-Large	15.60

## WHITE KNIT WITH WHITE POLYURETHANE PALM GLOVES

- Floats on water
- High energy absorption and low elongation
- Anatomically formed for added comfort
- Resistant to abrasion, moisture, UV rays, mildew, chemicals and detergents
- Cut resistance unaffected by washing
- Colour: White on white
- Meets EN388 level 2 for cut resistance



Model No.	Mfg. No.	Size	Price /Each
SAJ773	Y9266-7	7	13.60
SAJ774	Y9266-8	8	13.60

Model No.	Mfg. No.	Size	Price /Each
SAJ775	Y9266-9	9	13.60
SAJ776	Y9266-10	10	13.60



## HANDGUARD II GLOVES

- The patented combination of Kevlar®, Spectra® and stainless steel makes this a heavy-duty glove
- Unmatched combination of cut resistance and comfort
- Excellent thermal properties
- Ambidextrous
- Colour: White
- Meets ANSI/ISEA 105 Level 5 for cut resistance

Model No.	Mfg. No.	Size	Price /Each
SQ233	333019	X-Small	33.50
SQ234	333021	Small	33.50
SQ235	333023	Medium	33.50
SQ236	333025	Large	33.50
SQ237	333027	X-Large	33.50



## HPPE LINED SPLIT COWHIDE GLOVES - CUT RESISTANCE LEVEL A6

- 10-gauge seamless fitted HPPE liner
- Liner is made out of extremely strong fibres of HPPE (high performance polyethylene)
- Superior cut, abrasion and tear resistance
- Sewn with Twaron® thread for higher seam strength and resistance
- Rubberized safety cuff
- Full leather-tipped fingers and knuckle strap
- ASTM ANSI LEVEL A6
- EN 388 Performance Levels: 4X44F
- Case Qty:72
- Sold per pair

Model No.	Size	Price /Each
SDN114	Large	15.50
SDN162	X-Large	15.50



## STAINLESS STEEL MESH GLOVES

- This double interlocked metal mesh ambidextrous glove is formed using state-of-the-art micro plasma welding techniques. The result is stronger, smoother, hermetically sealed ring connections that have no gaps or weak spots.
- The self-adjusting tensioning system allows for easy fit with no straps or buckles to fasten. There is no fabric cuff to wear out or become contaminated. The glove is easy to clean.
- Meets ANSI/ISEA 105 Level 5 for cut resistance



Model No.	Mfg. No.	Size	Price /Each
SAI315	CM030001	X-Small	234.00
SAI316	CM030002	Small	234.00
SAI317	CM030003	Medium	234.00

Model No.	Mfg. No.	Size	Price /Each
SAI318	CM030004	Large	234.00
SAI319	CM030005	X-Large	234.00



# HAND PROTECTION

## HYFLEX® 11-644 GLOVES

- Ansell Cut Protection Technology™ combines a proprietary blend of high performance polyethylene yarn with a polyurethane palm coating
- Molds naturally to the hand--preventing fatigue
- Soft and cool to the skin for all-day comfort
- Exclusive engineered yarn combination provides exceptional precision, dexterity, and flexibility when handling small parts
- Proprietary gray polyurethane coating provides a sure grip in both light oil and dry applications
- Increases worker assurance when handling sharp objects
- Excellent resistance to tears and punctures
- Gray palm coating hides soil providing longer wear and reducing overall replacement costs
- Polyurethane provides excellent abrasion resistance for long life
- Product can be washed and re-used without any loss of cut protection
- Meets ANSI/ISEA 105 Level 2, EN388 Level 2 for cut resistance

**Applications:** Aerospace, automotive, construction, electronics, glass products, metal fabrication, paper manufacturing, plastic & rubber manufacturing, transportation

Model No.	Mfg. No.	Size	Price /Each
SDM682	111673	6	11.20
SDM683	111674	7	11.20
SDM684	111675	8	11.20
SDM685	111676	9	11.20
SDM686	111677	10	11.20
SDM687	111678	11	11.20
SDM688	111679	12	11.20



**Ansell**

## HYFLEX® 11-738 GLOVES

- INTERCEPT™ Technology for extreme cut protection
- Fortix™ Technology provides extended use with up to 12x more durability in the thumb crotch region versus unreinforced glove equivalents
- Enhanced dexterity and comfort due to no coating strike through
- Skin-friendly, water-based polyurethane and NBR coating
- For use in the automotive, glass, machinery and equipment, metal, and transport equipment industries
- Oeko-Tex® 100 approved
- Gauge: 13
- Coating: Nitrile/Polyurethane
- Cut Resistance: ASTM ANSI Level A4
- ANSI Abrasion Level: 5

**Ansell**

Model No.	Mfg. No.	Size	Price /Each
SGH292	11738060	6	16.20
SGH293	11738070	7	16.20
SGH294	11738080	8	16.20
SGH295	11738090	9	16.20
SGH296	11738100	10	16.20
SGH297	11738110	11	16.20



## POINTGUARD™ X GLOVES

- Highest needlestick resistance available provided by the layering of SuperFabric® brand material
- Tested using 25 gauge needles
- Highest levels of cut-resistance on noted enhanced areas
- Recommended use as an under-glove solution with appropriate top-glove combination
- Lightweight spandex shell with elastic wrist support
- Machine washable
- Meets ANSI/ISEA 105 Level 5 for cut resistance

**Applications:** Waste recycling and sorting, waste water treatment/sewage, hospital waste handling and laundry and correctional facility pat-downs/searches



Model No.	Mfg. No.	Size	Price /Each
SAN777	6044-XS	X-Small	199.00
SAN778	6044-S	Small	199.00
SAN779	6044-M	Medium	199.00
SAN780	6044-L	Large	199.00
SAN781	6044-XL	X-Large	199.00

**HexArmor**  
the science of safety.

## G60 PURPLE NITRILE\* GLOVES

- High level of cut resistance with enhanced dexterity, grip and comfort
- Ambidextrous and breathable with a flexible dotted palm for better grip
- Meets ANSI Level 3, EN388 level 3 for cut resistance

**Applications:** Metal fabrication, glass handling, handling of sharp objects, automotive assembly



## KLEENGUARD™

Model No.	Mfg. No.	Size	Price /Each
SAQ352	97430	Small (7)	22.20
SAQ353	97431	Medium (8)	22.20
SAQ354	97432	Large (9)	22.20
SAQ355	97433	X-Large (10)	22.20
SAQ356	97434	2X-Large (11)	22.20

## MECHANICS+ 4018 GLOVES

- High comfort and dexterity
- Cut and abrasion-resistant knuckle patch
- Synthetic leather palm provides reliable grip in dry or light oil situations
- Hook and loop closure for secure fit
- Machine washable
- Meets ANSI/ISEA 105 Level 5 for cut resistance

**Applications:** Shop work, general work, mechanical work



Model No.	Mfg. No.	Size	Price /Each
SAP648	4018-S	Small	129.00
SAP649	4018-M	Medium	129.00
SAP650	4018-L	Large	129.00
SAP651	4018-XL	X-Large	129.00
SAP652	4018-XXL	2X-Large	129.00

**HexArmor**  
the science of safety.

## G60 GLOVES

- Liner offers a comfortable fit, while polyurethane coating enhances grip and dexterity and provides an oil barrier
- Suitable for intermittent heat contact (up to 212°F)
- Features both dexterity and cut resistance for risk of minor cuts and abrasions
- Each pair has a dedicated right and left glove for a snug fit, and coated knuckles for extra protection
- Gauge: 15
- Shell Material: Kevlar®
- Cut Resistance: ANSI/ISEA 105 Level 2, EN 388 Level 2
- Coating Style: 3/4 Dipped

## KLEENGUARD™

Model No.	Mfg. No.	Size	Price /Each
SGQ321	38642	7	13.90
SGQ322	38643	8	13.90
SGQ323	38644	9	13.90
SGQ324	38645	10	13.90
SGQ325	38646	11	13.90



## MAXIFLEX® CUT™ SEAMLESS KNIT GLOVES

- Reinforcement between the thumb and forefinger
- Form, fit and feel mimics the "hand at rest", reducing hand fatigue and increasing comfort
- Latest knitting technology used to produce smooth and rounded fingertips, improving fingertip sensitivity
- Consistent liner penetration from the nitrile, leaving only the soft liner resting against the skin
- Optimized grip delivered through the micro-cup finish
- The Oeko-Tex® Association has evaluated and certified this product as skin safe from the second it comes into contact with the skin
- Accepted for use in Canadian food processing facilities
- Gauge: 15
- Shell Material: Polyethylene
- Cut Resistance: ANSI/ISEA 105 Level 2, EN 388 Level 3
- Coating: Foam Nitrile
- Coating Style: Dipped Palm, Dotted Palm
- Abrasion Resistance: EN 388 Level 4
- Puncture Resistance: EN 388 Level 1
- Tear Resistance: EN 388 Level 3



Model No.	Mfg. No.	Size	Price /Each
SDL446	GP348743XS	X-Small	14.70
SDL447	GP348743S	Small	14.70
SDL448	GP348743M	Medium	14.70
SDL449	GP348743L	Large	14.70
SDL450	GP348743XL	X-Large	14.70
SDL451	GP348743XXL	2X-Large	14.70

## MAXICUT® ULTRA™ GLOVES

- Reinforcement between the thumb and forefinger
- Silicone free
- Patented micro-foam nitrile coating offers 360° breathability
- Form, fit and feel mimics the "hand at rest", reducing hand fatigue and increasing comfort
- Latest knitting technology utilized to produce smooth and rounded fingertips, improving fingertip sensitivity
- Consistent liner penetration from the nitrile, leaving only the soft liner resting against the skin
- This glove has been laundered prior to final packaging making it clean and safe for use
- The Oeko-Tex® Association has evaluated and certified this product as skin safe from the second it comes into contact with the skin
- Complies with FDA food handling requirements 21 CFR, Part 177
- Gauge: 15
- Shell Material: HPPE
- Cut Resistance: EN 388 Level 5, ASTM ANSI Level A3, EN 388 Level C
- Coating: Foam Nitrile
- Coating Style: Dipped Palm
- Abrasion Resistance: EN 388 Level 4
- Tear Resistance: EN 388 Level 4
- Puncture Resistance: EN 388 Level 2



Model No.	Mfg. No.	Size	Price /Each
SGW524	GP443745S	Small	21.50
SGW525	GP443745M	Medium	21.50
SGW526	GP443745L	Large	21.50
SGW527	GP443745XL	X-Large	21.50
SGW528	GP443745XXL	2X-Large	21.50

## MAXIFLEX® CUT™ TOUCHSCREEN COMPATIBLE GLOVES

- DuPont™ Kevlar® is light, comfortable and enduring protection against heat, cuts, lacerations and abrasions
- Polyester synthetic fiber offers good abrasion resistance and an amount of chemical resistance
- MicroFoam nitrile coating allows gloves to be thinly coated for added grip, dexterity, comfort and breathability
- Reinforcement between the thumb and forefinger
- Touchscreen compatible
- Minimal penetration (strike through) leaving only the soft liner resting against the skin
- Silicone free
- Gauge: 15
- Cut Resistance: EN 388 Level 3, ASTM ANSI Level A4, EN 388 Level D
- Coating Style: Dipped Palm
- Abrasion Resistance Rating: EN 388 Level 4
- Tearing Strength Rating: EN 388 Level 3
- Puncture Resistance Rating: EN 388 Level 1



Model No.	Mfg. No.	Size	Price /Each
SGX450	34-1743/XS	X-Small	32.40
SGX451	34-1743/S	Small	32.40
SGX452	34-1743/M	Medium	32.40
SGX453	34-1743/L	Large	32.40
SGX454	34-1743/XL	X-Large	32.40
SGX455	34-1743/XXL	2X-Large	32.40

## MAXIFLEX® CUT™ GLOVES

- MicroFoam nitrile coatings are compatible with light oils
- Raised micro dots increase durability
- Reinforcement between the thumb and forefinger
- Patented micro-foam nitrile coating offers 360° breathability
- Latest knitting technology utilized to produce smooth and rounded fingertips, improving fingertip sensitivity
- Optimized grip delivered through micro-cup finish, allows for a controlled grip
- All ingredients used in the manufacturing and construction of this product are compliant with the REACH legislation
- This glove has been laundered prior to final packaging making it clean and safe for use
- The Oeko-Tex® Association has evaluated and certified this product as skin safe
- The Skin Health Alliance has awarded professional dermatological accreditation
- Gauge: 15 • Shell Material: Engineered Yarn
- Cut Resistance: EN 388 Level 3, ASTM ANSI Level A2, EN 388 Level B
- Coating: Foam Nitrile
- Coating Style: Dipped Palm, Dotted Palm
- Abrasion Resistance: EN 388 Level 4
- Tear Resistance: EN 388 Level 3
- Puncture Resistance: EN 388 Level 1



Model No.	Mfg. No.	Size	Price /Each
SGW529	GP348443S	Small	16.70
SGW530	GP348443M	Medium	16.70
SGW531	GP348443L	Large	16.70
SGW532	GP348443XL	X-Large	16.70
SGW533	GP348443XXL	2X-Large	16.70

## CR5 ORIGINAL® GLOVES

- Fluorescent, ANSI-107 compliant TrekDry® material helps keep hands cool and comfortable
- Synthetic palm with an internal layer of Armortex® delivers CE level 5 cut resistance
- Thermal Plastic Rubber (TPR) closure with hook and loop provides a secure fit
- Reinforcement panels in high wear areas improve durability
- Gauge: Non-Knit
- Shell Material: Kevlar®, Nylon
- Cut Resistance: EN 388 Level 5



Model No.	Mfg. No.	Size	Price /Each
SFU961	SMG-C91-008	Small, 8	45.10
SFU962	SMG-C91-009	Medium, 9	45.10
SFU963	SMG-C91-010	Large, 10	45.10
SFU964	SMG-C91-011	X-Large, 11	45.10
SFU965	SMG-C91-012	2X-Large, 12	45.10

## SPEEDKNIT™ B2 GLOVES

- Polyurethane (PU) palm coating is highly dexterous, flexible and provides excellent grip in wet, dry and oil conditions
- Constructed with seamless 15-gauge high performance polyethylene (HPPE) to protect working hands
- Machine washable
- Intended uses include maintenance and repair, equipment operation, box handling, landscaping, home improvement, manufacturing, and construction
- Cut Resistance: ASTM ANSI Level A2, EN 388 Level B
- Abrasion Resistance Rating: EN 388 Level 3
- Tearing Strength Rating: EN 388 Level 4
- Puncture Resistance Rating: EN 388 Level 2



Model No.	Mfg. No.	Size	Price /Each
SGV262	S2DD-03-007	Small, 7	9.09
SGV263	S2DD-03-008	Medium, 8	9.09
SGV264	S2DD-03-009	Large, 9	9.09
SGV265	S2DD-03-010	X-Large, 10	9.09
SGV266	S2DD-03-011	2X-Large, 11	9.09



# HAND PROTECTION

## FLOCKED-LINED GREEN NITRILE GLOVES

- Silicone-free
- Cotton flock-lined
- Raised diamond pattern provides superior grip
- Resistant to cuts, puncture and abrasion
- 13" length, 15-mil thick
- Accepted for use in Canadian food processing facilities

**Applications:** Food processing, plant maintenance, chemical processing, automotive and printing



Model No.	Size	Price /Each
STANDARD QUALITY		
SHF683	7	1.80
SHF684	8	1.80
SHF685	9	1.80
SHF686	10	1.80
SHF687	11	1.80

Model No.	Size	Price /Each
PREMIUM QUALITY		
SEF083	7	2.25
SEF084	8	2.25
SEF085	9	2.25
SEF086	10	2.25
SEF087	11	2.25



SEF085

## UNLINED GREEN NITRILE GLOVES

- Silicone-free
- Lightweight unlined nitrile gloves
- Raised diamond pattern provides superior grip
- Resistant to cuts, puncture, and abrasion
- 13" length, 11-mil thick
- Accepted for use in Canadian food processing facilities

**Applications:** Food processing, plant maintenance, chemical processing, automotive and printing

Model No.	Size	Price /Each
STANDARD QUALITY		
SHF678	7	1.75
SHF679	8	1.75
SHF680	9	1.75
SHF681	10	1.75
SHF682	11	1.75

Model No.	Size	Price /Each
PREMIUM QUALITY		
SEF222	7	2.30
SEF223	8	2.30
SEF224	9	2.30
SEF225	10	2.30
SEF226	11	2.30



SEF224



## SOL-VEX® UNSUPPORTED NITRILE 37-175 GLOVES

- Embossed, flock-lined
- Good protection against snags, punctures, abrasions and cuts
- Outstanding combination of strength and chemical resistance, when exposed to aromatic and petroleum solvents, as well as caustics and animal fats, they won't swell, weaken or degrade
- Superior choice over rubber or neoprene
- 13" length, 17-mil thick
- Accepted for use in Canadian food processing facilities

**Applications:** Food processing (red meat, poultry, vegetables, fruit, dairy and canning), automotive assembly and painting, aerospace and automotive degreasing, chemical processing, oil refining, petrochemicals, machining operations using cutting oil and coolants, metal fabrication, graphic arts, printing cleanup, furniture manufacturing, electronics (semiconductors, circuit board manufacturing)

Model No.	Size	Price /Each
SAW941	6	2.53
SAW942	7	2.53
SAW943	8	2.53
SAW944	9	2.53
SAW945	10	2.53
SAW946	11	2.53



SAW941



## UNLINED GREEN NITRILE GLOVES

- Unlined for improved dexterity
- Raised diamond pattern provides superior grip
- Resistant to cuts, puncture and abrasion
- 15" length, 22-mil thick
- Accepted for use in Canadian food processing facilities

**Applications:** Food processing, plant maintenance, chemical processing, automotive and printing

Model No.	Size	Price /Each
STANDARD QUALITY		
SHF693	8	6.95
SHF694	9	6.95
SHF695	10	6.95

Model No.	Size	Price /Each
PREMIUM QUALITY		
SEF080	8	7.65
SEF081	9	7.65
SEF082	10	7.65



SEF080



## NITRI-SOLVE® GLOVES

- Nitri-Solve® provides excellent protection against abrasion, punctures, cuts and snags
- Resistant to a broad range of solvents, animal fats and other chemicals
- Case-hardened finish enhances both chemical and abrasion resistance and makes it easy to pull on and off
- Non-slip grip makes wet work easier and safer
- Available in flock-lined and unlined styles in varying thickness and lengths
- Each hand is embossed with glove size for ease of pairing after laundering
- Colour: Green
- Accepted for use in Canadian food processing facilities
- Made of FDA compliant materials

**Applications:** Food processing, hazmat splash protection, laboratories, janitorial, paint applications, fuel handling and refineries

Model No.	Mfg. No.	Size	Length"	Thickness Mils	Case Qty	Price /Each
FLOCK-LINED						
SA578	730S-07	7	13	15	144	2.55
SA579	730M-08	8	13	15	144	2.55
SA580	730L-09	9	13	15	144	2.55
SA576	730XL-10	10	13	15	144	2.55
SA577	730XXL-11	11	13	15	144	2.55
UNLINED						
SA566	717S-07	7	13	11	144	2.55
SA567	717M-08	8	13	11	144	2.55
SA568	717L-09	9	13	11	144	2.55
SA564	717XL-10	10	13	11	144	2.55
SA565	717XXL-11	11	13	11	144	2.55
UNLINED, HEAVY-DUTY						
SA0807	737M-8	8	15	22	72	7.40
SA0808	737L-9	9	15	22	72	7.40
SA0809	737XL-10	10	15	22	72	7.40
SA0810	737XXL-11	11	15	22	72	7.40



SA580



SA568



SA0808



## NSK24™ NITRI-SOLVE KNIT-LINED NITRILE GLOVES

- Super flexible, watertight nitrile glove
- Interlock knit lining offers an added degree of comfort and protection
- Provides excellent protection from an array of solvents, oils and acids
- Rough finish texture delivers a sure grip in even the most oily and wet applications
- Length: 14", 24-mil thick

**Applications:** Oily greasy applications, refineries, protection from hexavalent chromium, protection from fuels, food handling applications

Model No.	Mfg. No.	Size	Price /Each
SAN698	NSK24M-09	9	8.98
SAN699	NSK24L-10	10	8.98
SAN700	NSK24XL-11	11	8.98



SAN698



## NATURAL RUBBER LATEX CANNERS GLOVES

- Unlined
- Embossed diamond pattern provides superior grip
- Chlorinated for easy donning
- 12" length, 18-mil thick

**Applications:** Food processing, plant maintenance and janitorial applications



Model No.	Size	Price /Each
<b>STANDARD QUALITY</b>		
SHF700	7	1.50
SHF701	8	1.50
SHF702	9	1.50
SHF703	10	1.50

Model No.	Size	Price /Each
<b>PREMIUM QUALITY</b>		
SEI692	7	1.85
SEI693	8	1.85
SEI694	9	1.85
SEI695	10	1.85

## NATURAL RUBBER LATEX GLOVES

- Embossed diamond pattern provides superior grip
  - Chlorinated for easy donning
  - 12" length, flock lined
  - **18-mil gloves:** Accepted for use in Canadian food processing facilities
- Applications:** Food processing, plant maintenance and janitorial applications



### STANDARD QUALITY

Model No.	Size	Price /Each
<b>15 MILS, SILICONE-FREE</b>		
SHF670	7	1.15
SHF671	8	1.15
SHF672	9	1.15
SHF673	10	1.15
<b>18 MILS</b>		
SHF674	7	1.35
SHF675	8	1.35
SHF676	9	1.35
SHF677	10	1.35

### PREMIUM QUALITY

Model No.	Size	Price /Each
<b>15 MILS, SILICONE-FREE</b>		
SCG928	6	1.45
SEF204	7	1.45
SEF205	8	1.45
SEF206	9	1.45
SEF207	10	1.45
<b>18 MILS</b>		
SEF005	7	1.60
SEF006	8	1.60
SEF007	9	1.60
SEF008	10	1.60



## NATURAL BLUE™ 356 GLOVES

- Cotton flock lining offers increased user comfort
- Excellent chemical, snag, puncture, abrasion and cut resistance Applications: Food processing, automotive manufacturing, chemical plants, and plant maintenance
- Caution: This product contains natural rubber latex which may cause allergic reactions in some individuals
- Length: 12"
- Thickness: 20-mil
- Cuff Style: Pinked
- Shell Material: Rubber Latex
- Inner Lining: Unlined
- Case Quantity: 144
- Finish: Embossed
- Colour: Blue



Model No.	Mfg. No.	Size	Price /Each
SHB546	35611070	Small, 7	2.18
SHB547	35611080	Medium, 8	2.18
SHB548	35611090	Large, 9	2.18
SHB549	35611100	X-Large, 10	2.18

## ALPHATEC™ 58-535B GLOVES

- Nitrile with Ansell Grip Technology™
- New anatomical hand shape
- Easier donning
- Good grip
- Excellent chemical protection, repel oils and other lubricants
- Provides dexterity, comfort and touch sensitivity without any compromise in chemical protection
- Reducing hand fatigue and carpal tunnel syndrome related injuries
- Fully coated with 14", 13-mil thick knitted seamless liner
- Accepted for use in Canadian food processing facilities

**Applications:** Chemical handling, agriculture, automotive / OEM, mining, aerospace, printing



Model No.	Size	Price /Each
SDS926	7	12.40
SDS927	8	12.40
SDS928	9	12.40

Model No.	Size	Price /Each
SDS929	10	12.40
SDS930	11	12.40



SDS926

## DISPOSABLE CHEMICAL-RESISTANT GLOVES

- Blending the best of disposable and chemical-resistant technology
- The perfect hybrid for jobs requiring chemical performance and optimum fit, feel and comfort
- A thin, light glove with a second-skin feel
- Protects the hand from oils, hydrocarbons, grease and abrasion, with effective long-lasting grip
- Impermeable for working in damp or greasy environments
- Cuff prevents dirt from entering the glove
- Easy to put on and remove
- Embossed finish with tractor-tread pattern
- Hand-specific
- Lint-free and dust-free
- Length: 12"
- Thickness: 9-mil
- Cuff Style: Rolled
- Shell Material: Nitrile
- Inner Lining: Unlined



SGD757

Model No.	Mfg. No.	Size	Price /Each
SGD757	707D-06	X-Small, 6	2.05
SGD758	707D-07	Small, 7	2.05
SGD759	707D-08	Medium, 8	2.05
SGD760	707D-09	Large, 9	2.05
SGD761	707D-10	X-Large, 10	2.05
SGD762	707D-11	2X-Large, 11	2.05

## SHOULDER LENGTH NITRILE GLOVES

- Seamless nitrile makes glove water tight
- Elastic closure near the shoulder ensures dryness and comfort
- Rough finish for excellent wet grip and abrasion resistance
- 26" length, 30-mil thick



Model No.	Mfg. No.	Size	Price /Each
SAP527	772M-08	Medium	23.60
SAP528	772L-09	Large	23.60
SAP529	772XL-10	X-Large	23.60



SAP527



## LINED ORANGE LATEX GLOVES

- 28-mil palm is thicker than most standard flock-lined gloves
- Diamond pattern on palm provides better grip on wet or dry surfaces
- Provides increased puncture/cut protection and tensile strength against chemical and physical hazards
- Length: 13"
- Cuff Style: Beaded
- Material: Rubber Latex
- **Applications:** Chemical processing, petroleum refineries, plant maintenance, heavy equipment assembly and clean-up

Model No.	Size	Price /Each
STANDARD QUALITY		
SHF704	Small (7)	2.15
SHF705	Medium (8)	2.15
SHF706	Large (9)	2.15
SHF707	X-Large (10)	2.15

Model No.	Size	Price /Each
PREMIUM QUALITY		
SGH421	Small (7)	2.55
SGH422	Medium (8)	2.55
SGH423	Large (9)	2.55
SGH424	X-Large (10)	2.55

## NATURAL RUBBER LATEX HEAVYWEIGHT GLOVES

- Silicone-free
- Provides superior protection from water-based chemicals such as acids, alkalis, alcohols and caustics
- Heavy rolled bead cuff for excellent tear resistance
- Smooth finish resists punctures and snags
- Unlined for less risk of product contamination
- 30-mil thickness

**Applications:** Chemical handling, plating, sandblasting, plant maintenance and laboratories

Model No.	Length"	Price /Each
SAP220	14	4.15
SAP221	18	5.75



SAP220

## ALPHATEC® 88-356 CHEMICAL-RESISTANT FOOD-PROCESSING GLOVES

- Industrial gloves compliant with FDA food handling regulations
- Certification(s): CE 0493, EN ISO 374-2016 Type B KPT, EN ISO 374-5 VIRUS
- Fish scale texture, ensuring excellent grip for both dry and wet handling
- Special chlorination process to reduce the risk of allergic reactions
- With 17 mil/0.43mm thickness, these AlphaTec® gloves remain thin, yet durable, with high levels of tactility, sensitivity and dexterity
- EN 374 Type B chemical protection, ideal for low-hazard applications, such as detergent cleaning, as well as mildly acidic, oily food processing
- Tearing Strength Rating: EN 388 Level 1
- Length: 12"
- Cuff Style: Pinked
- Shell Material: Rubber Latex
- Inner Lining: Unlined
- Coating Colour: Blue



SHB546



Model No.	Mfg. No.	Size	Price /Each
SHB546	0035611070	7	2.18
SHB547	0035611080	8	2.18
SHB548	0035611090	9	2.18

Model No.	Mfg. No.	Size	Price /Each
SHB549	00356111100	10	2.18
SHB550	00356111110	11	2.18

## VERSATOUGH® 297 NATURAL RUBBER GLOVES

- Medium-duty natural rubber unsupported latex
- Cotton flock-lined • Increased snag, puncture, abrasions and cut resistance
- High degree of tensile strength
- Excellent sensitivity
- Added wrist and forearm protection
- Improved grip on wet or dry objects
- 12" length, 20-mil thick, pebble-embossed
- Accepted for use in Canadian food processing facilities

**Applications:** Canning and food processing, Agriculture, Automotive assembly, Chemical plants, Janitorial, Petroleum refineries, Plant maintenance, Pharmaceutical manufacturing

**Caution:** These products contain natural rubber latex which may cause allergic reactions in some individuals.

Model No.	Size	Price /Each
SAW947	7	1.89
SAW948	8	1.89

Model No.	Size	Price /Each
SAW949	9	1.89
SAW950	10	1.89



SAW947

## ORANGE HEAVYWEIGHT 208 SERIES GLOVES

- Increased tensile strength and puncture/cut protection against chemical and physical hazard
- 29-mil palm is 50% thicker than most standard flock-lined glove
- Recessed diamond design provides grip on wet or dry objects
- 100% cotton flock lining increases user comfort
- 13" length, 29-mil thick

**Applications:** Chemical processing, petroleum refineries, plant maintenance, heavy equipment assembly and clean-up

**Caution:** This product contains natural rubber latex which may cause allergic reactions in some individuals



SAX914



Model No.	Mfg. No.	Size	Price /Each
SAX914	0020811070	Small	3.65
SAX915	0020811080	Medium	3.65
SAX916	0020811090	Large	3.65

Model No.	Mfg. No.	Size	Price /Each
SAX917	0020811100	X-Large	3.65
SAX918	0020811110	2X-Large	3.65

## CHEM MASTER® GLOVES

- Unsupported neoprene over natural rubber glove
- Tactile sensitive with a tractor tread grip
- Applications: Battery manufacturing, chemical plants, aircraft assembly, food processing and plant maintenance
- Length: 13"
- Thickness: 26-mil
- Cuff Style: Straight
- Inner Lining: Flock-Lined
- Finish: Tractor tread
- Colour: Black/Blue
- Case Quantity: 144



SA605

Model No.	Mfg. No.	Size	Price /Each
SA605	CHML-09	Large, 9	3.45
SA606	CHMM-08	Medium, 8	3.45
SA607	CHMS-07	Small, 7	3.45
SA608	CHMXL-10	X-Large, 10	3.45

## ALPHATEC® 87-320 CHEMICAL-RESISTANT GLOVES

- Beaded cuff for tear resistance and easy donning
- Food approved
- Good abrasion resistance
- Length: 11.8"
- Thickness: 17-mil
- Shell Material: Rubber Latex
- Inner Lining: Flock-Lined, Cotton
- Chlorinated: Yes
- Coating Colour: Orange
- Grip Design: Reversed Lozenge
- Silicone-Free: Yes



SHB547



Model No.	Mfg. No.	Size	Price /Each
SHB544	87320085	8.5	23.80
SHB545	87320095	9.5	23.80

Model No.	Mfg. No.	Size	Price /Each
SHB542	87320065	6.5	23.80
SHB543	87320075	7.5	23.80



## ALPHATEC® 87-118 GLOVES

- Beaded cuff for easy donning /doffing
- Diamond grip pattern
- Cuff improves tear resistance and helps prevent droplets travelling beyond the glove
- High resistance to water based chemical
- Good resistance to abrasion
- Resistant and flexible, suitable for many industrial applications
- AQL 0.65
- Industries: Metal fabrication, Machinery and Equipment and Automotive Aftermarket
- Length: 12"
- Thickness: 30-mil
- Cuff Style: Rolled
- Shell Material: Rubber Latex
- Inner Lining: Flock-Lined
- Case Quantity: 144
- Colour: Black



SAJ995

Model No.	Mfg. No.	Size	Price /Each
SAJ993	6435	Small, 7	4.42
SAJ994	6436	Medium, 8	4.42
SAJ995	6437	Large, 9	4.42
SAJ996	6438	X-Large, 10	4.42
SAJ997	6439	2X-Large, 11	4.42

## NEOPRENE/NATURAL RUBBER LATEX GLOVES

- Silicone-free
- Natural rubber latex with blue neoprene over-dip
- Cotton flock-lined
- Raised diamond pattern provides superior grip
- Superior chemical resistance
- 12" length, 20-mil thick
- Accepted for use in Canadian food processing facilities

**Applications:** Food processing, plant maintenance, chemical processing, automotive and printing



SAM650

Model No.	Size	Price /Each
STANDARD QUALITY		
SHF696	7	2.75
SHF697	8	2.75
SHF698	9	2.75
SHF699	10	2.75

Model No.	Size	Price /Each
PREMIUM QUALITY		
SAM650	7	3.45
SAM651	8	3.45
SAM652	9	3.45
SAM653	10	3.45

## ALPHATEC® 87-029 GLOVES

- Unique roughened finished with superb wet & dry grip performance
- Good grip in both wet and dry environments due to the crinkle finish
- Polyamide seamless liner - Wrinkle natural rubber latex coating on the hand, smooth coating on the cuff
- High flexibility and excellent dexterity
- 13 gauge seamless nylon liner
- Primary industries: Janitorial / Sanitation, Machinery and Equipment, Food Processing and Chemical
- Length: 12"
- Thickness: 50-mil
- Cuff Style: Pinked
- Inner Lining: Nylon
- Case Quantity: 120
- Colour: Blue



SAP536

Model No.	Mfg. No.	Size	Price /Each
SAP536	M999965	Small, 7	7.53
SAP537	M999966	Medium, 8	7.53
SAP538	M999967	Large, 9	7.53
SAP539	M999968	X-Large, 10	7.53

## NEOPRENE™ 29-865 GLOVES

- Flock-lined unsupported neoprene, embossed
- Increase chemical and abrasion resistance over standard neoprene gloves
- Broad-spectrum protection
- Excellent resistance to a wide range of chemicals, including oils, acids, caustics and solvents
- 13" length, 18-mil thick
- Accepted for use in Canadian food processing facilities

**Applications:** Petrochemicals, degreasing, electronics, refining, handling oils, acids, caustics, alcohols and solvents



SAX979

Model No.	Size	Price /Each
SAX979	7	7.81
SAX980	8	7.81
SAX981	9	7.81
SAX982	10	7.81

## CS710 CHEMICAL-RESISTANT GLOVES

- A double-dipped nitrile coating offers robust durability, whilst the seamless liner and natural latex-free composition ensure comfort during long periods of wear
- Enhanced grip from the foamed nitrile palm coating provides extra grip, even in oily or slippery environments
- Oil-resistant
- Seamless knit
- Natural rubber latex-free
- Shell Material: Polyester
- Inner Lining: Unlined
- Sold per pack of 12 pairs



SHB559

LENGTH: 12"

Model No.	Mfg. No.	Size	Price /Each
SHB559	CS710S-07	7	95.80
SHB560	CS710M-08	8	95.80
SHB561	CS710L-09	9	95.80
SHB562	CS710XL-10	10	95.80
SHB563	CS710XXL-11	11	95.80

LENGTH: 14"

Model No.	Mfg. No.	Size	Price /Each
SHB564	CS711S-07	7	107.00
SHB565	CS711M-08	8	107.00
SHB566	CS711L-09	9	107.00
SHB567	CS711XL-10	10	107.00
SHB568	CS711XXL-11	11	107.00

## PREMIUM GRADE NEOPRENE GLOVES

- Caustics, oils, greases and solvents resistant
- Excellent all-round protection against physical hazards such as abrasion and cuts
- Choice of smooth or rough grip
- Heavyweight thickness
- One size

**Applications:** Degreasing, petrochemicals, refining, metal fabricating, plating, galvanizing and general material handling



SC455



SC454

Model No.	Mfg. No.	Length"	Grip	Price /Each
SC454	6780	12	Smooth	16.10
SC455	6780R	12	Rough	16.80
SC456	6784	14	Smooth	16.80
SC457	6784R	14	Rough	17.50

# HAND PROTECTION

## PVC DOUBLE DIPPED GLOVES

- Double dipped PVC offers superior durability, abrasion and chemical resistance
- Cotton jersey lining
- Rough coating provides optimal grip
- Resistant to most oils, acids, greases and solvents
- Colour: Green

**Applications:** Fisheries, petrochemical industry, mining



Model No.	Description	Price /Each
SEE800	Gauntlet 12"	3.75
SEE801	Gauntlet 14"	4.10
SEE802	Gauntlet 18"	5.75
SEE803	Knit Wrist	3.05

## PVC ULTRA FLEXIBLE GLOVES

- Silicone-free
- Premium ultra flexible PVC coating
- Seamless 13-gauge interlock lining
- Pre-formed shape for ultimate dexterity, comfort and tactile sensitivity
- Double dipped PVC offers superior durability, abrasion and chemical resistance
- 12" length
- Rough coating provides optimal grip
- Colour: Blue

**Applications:** Fisheries, general maintenance, automotive, petrochemical industry



Model No.	Size	Price/Each
SAP878	9	5.95
SAP879	10	5.95



## 3415 GLOVES

- Protects against a wide range of chemicals including acids, caustics, solvents, greases and oils
- Flexible neoprene coating provides great comfort and dexterity
- 15-Gauge seamless polyester knitting
- Rough particle finish offers good resistance to abrasion
- Constructed with seamless polyester to prevent irritation
- An ergonomically designed hand former replicates the natural shape of the human hand, thus reduces hand fatigue and enhances fit and comfort

Model No.	Mfg. No.	Size	Price /Each
SFI903	3415S-08	Small (8)	13.30
SFI904	3415M-09	Medium (9)	13.30
SFI905	3415L-10	Large (10)	13.30
SFI906	3415XL-11	X-Large (11)	13.30



## SNORKEL® 04-644 GLOVES

- Jersey lining provides cushioned comfort and moderate insulation
- Excellent wet grip
- Flexible PVC coated glove
- Optimum abrasion resistance
- Excellent chemical resistance to petrochemicals and acids

**Applications:** Fisheries, petrochemicals refining, handling equipment and abrasive materials coated with acids, caustics, solvents, grease and oil

Model No.	Size	Price /Each
SAX959	8	5.87
SAX960	9	5.87
SAX961	10	5.87
SAX962	11	5.87



## PVC ROUGH FINISH GLOVES

- Bright yellow PVC on cotton interlock lining
- Resistant to most oils, acids, greases and solvents
- Rough coating provides optimal grip
- Colour: Yellow

**Applications:** Fisheries, petrochemical industry, mining



Model No.	Description	Price /Each
SEE797	Gauntlet 12"	2.70
SEE798	Gauntlet 14"	3.00
SEE799	Knit Wrist	2.35

## PVC SMOOTH FINISH GLOVES

- Bright red PVC on cotton interlock lining
- Resistant to most oils, acids, greases and solvents
- Ideal for general chemical handling
- Colour: Red

**Applications:** Fisheries, general maintenance, petrochemical industry



Model No.	Description	Price /Each
SEE804	Gauntlet 12"	2.45
SEE805	Gauntlet 14"	3.05
SEE806	Knit Wrist	2.40

## 3416 GLOVES

- Protection against a wide range of chemicals, including acids, caustics, solvents, grease and oil
- Flexible coating with maximum comfort and protection
- Tactile non-slip grip
- 13-gauge seamless cut-resistant engineered fibre
- Fully coated neoprene
- Rough particle finish
- Cut Resistance: ANSI/ISEA 105 Level 4, EN 388 Level 5
- Colour: Black



Model No.	Mfg. No.	Size	Price /Each
SGC450	3416S-08	Small	17.10
SGC451	3416M-09	Medium	17.10
SGC452	3416L-10	Large	17.10
SGC453	3416XL-11	X-Large	17.10

## BARRIER® CHEMICAL-RESISTANT GLOVES

- 5-layer laminated glove
- 100% inspected - each glove is individually air-pressure tested
- Wide Spectrum Resistance
- Thickness: 2.5-mil
- Length: 16"
- Material: HPPE
- Cuff Style: Gauntlet



Model No.	Mfg. No.	Size	Price /Each
SGL110	02-100-6	6	11.10
SGL111	02-100-7	7	11.10
SGL112	02-100-8	8	11.10

Model No.	Mfg. No.	Size	Price /Each
SGL113	02-100-9	9	11.10
SGL114	02-100-10	10	11.10
SGL115	02-100-11	11	11.10

## ALPHATEC® 58-128 CHEMICAL-RESISTANT GLOVES

- Reduces the risk of ergonomic injury caused by prolonged or repetitive manual tasks
- Maximizes worker productivity by minimizing hand fatigue and discomfort
- Conforms to the shape of the wearer's hand enabling natural movement
- Ergoform™ delivers high-performance musculoskeletal support during repetitive tasks and improves worker performance
- Unique technology yields a thin barrier while offering superior protection from oils and other irritant fluids
- Ansell Grip™ technology provides enhanced dexterity, grip and comfort for the handling of wet or oily parts
- The first ergonomically-certified chemical glove, it provides quantifiable ergonomic benefits to the wearer
- Thickness: 7-mil • Length: 13"
- Cuff Style: Straight • Material: Nitrile
- Lining: Nylon



SGL262

**Ansell**

Model No.	Mfg. No.	Size	Price /Each
SGL262	58-128-7	7	10.60
SGL263	58-128-8	8	10.60
SGL264	58-128-9	9	10.60

Model No.	Mfg. No.	Size	Price /Each
SGL265	58-128-10	10	10.60
SGL266	58-128-11	11	10.60

## PVC WINTER LINED GLOVES

- Bright orange PVC on jersey liner
- Resistant to most oils, acids, greases and solvents
- Foam fleece lining offers added warmth
- Colour: Orange

**Applications:** Fisheries, petrochemical industry, mining, outdoor winter conditions



SDN590

SDN592

SDN591

Produits de sécurité  
**ZENITH**™

Model No.	Description	Price /Each
SDN591	Gauntlet 12"	10.30
SDN590	Knit Wrist	7.00
SDN592	Safety Cuff	8.15

## POLAR GRIP® 23-700 GLOVES

- PVC-coated rough finish that remains soft when cold
- Excellent foam insulation against cold temperatures
- Curved fingers, wing thumb and soft insulating lining provide comfort
- Offers resistance to oils, acids, caustics and alcohols
- Rough finish surface provides excellent grip for handling of both wet and dry materials
- Nylon liner
- Accepted for use in Canadian food processing facilities

**Applications:** Fishing industry, cold storage, construction, winter transportation, yard and field work, freight handling and trash collection



**Ansell**

Model No.	Length"	Size	Price /Each
SEA274	11	9	21.70
SEB089	11	10	21.70

## ALPHATEC® 58-735 CHEMICAL & CUT-RESISTANT GLOVES

- Intercept™ Cut-Resistant Technology provides protection against lacerations
- Optimised fit that integrates the cut liner into nitrile shell for better dexterity & tactility versus double gloving
- Ansell Grip™ Technology for the handling of wet or oily parts providing enhanced dexterity, grip and comfort while reducing hand fatigue
- High-visibility cut liner acts as an indicator for when glove is cut, highlighting when chemical protection is compromised
- Cuff can be folded to act as a gutter to prevent chemicals running down the arm
- Cut Resistance: ASTM ANSI Level A3
- Thickness: 39-mil
- Length: 13"
- Cuff Style: Straight
- Material: Nitrile
- Lining: Nylon



SGL270

**Ansell**

Model No.	Mfg. No.	Size	Price /Each
SGL267	58-735-6	6	22.10
SGL268	58-735-7	7	22.10
SGL269	58-735-8	8	22.10

Model No.	Mfg. No.	Size	Price /Each
SGL270	58-735-9	9	22.10
SGL271	58-735-10	10	22.10
SGL272	58-735-11	11	22.10

## WINTER MONKEY GRIP® GLOVES

- PVC-coated foam-insulated
- Tough PVC coating stays soft when cold
- Keep hands warm and dry
- Protect from abrasion
- Curved fingers, wing thumb, and soft jersey lining make them very comfortable
- Fully coated
- Accepted for use in Canadian food processing facilities

**Applications:** Cold storage, winter transportation, yard and field work, unheated warehouses, construction

**Ansell**



SBA993

Model No.	Description	Size	Price /Each
SBA992	Knit Wrist	10	14.20
SBA993	Safety Cuff	10	16.00
SEE953	Raised Finish, Safety Cuff	10	14.10

## ACTIVARMR® 97-681 FULL-DIP GLOVES

- RIPEL™ Liquid Repellence Technology provides a fully waterproof glove
- PVC foam coating stays flexible down to -25°C
- Protects against cold wind, cold contact and cold moisture
- Flexible nylon layer protects against liquid and mechanical risks
- Soft and insulating acrylic provides comfort and warmth
- Gauge: Non-Knit
- Highly dextrous
- Coating Style: Full Dip
- Provides a sure grip
- Colour: Blue
- Cuff: Gauntlet



SGF670

**Ansell**

Model No.	Mfg. No.	Size	Price /Each
SGF670	97681080	8	20.80
SGF671	97681090	9	20.80
SGF672	97681100	10	20.80
SGF673	97681110	11	20.80

## ATLAS® TEMRES 282 GLOVES

- Breathable polyurethane coating
- Insulated acrylic liner for cold applications
- Excellent wet/dry grip
- Provides protection from liquids in cold conditions
- Thin, durable coating maximizes comfort and flexibility in very cold working environments
- Nitrile-coated fingertips for added protection

**Applications:** Outdoor work, cold weather construction, transportation, maintenance, janitorial, cold storage, highway work and freight handling

**SHOWA**



SEG975

Model No.	Mfg. No.	Size	Price /Each
SEG975	282M-08	Medium	32.40
SEG976	282L-09	Large	32.40
SEG977	282XL-10	X-Large	32.40
SEH643	282XXL-11	2X-Large	32.40



# HAND PROTECTION

## HEAVYWEIGHT GRIPPER ORANGE NITRILE GLOVES

- Fully textured ultra gripper tire pattern provides maximum wet and dry grip
- Exceptional tactile sensitivity
- Beaded cuff for added strength
- Protects against oil, grease and organic solvents
- Superior puncture and tear resistance
- Latex and powder-free
- Material: Nitrile
- Length: 9.5"
- Thickness: 7-mil
- Colour: Orange
- Medical Device Class: Non-Medical
- Box Quantity: 100

**Applications:** Manufacturing, maintenance, small parts handling, laboratory, painting and janitorial



Model No.	Size	Price /Each
SGY265	Medium	20.95
SGY266	Large	20.95
SGY267	X-Large	20.95
SGY268	2X-Large	20.95

## HEAVYWEIGHT BLACK NITRILE GLOVES

- Fully textured diamond pattern provides maximum wet and dry grip
- Exceptional tactile sensitivity
- Beaded cuff for added strength
- Protects against oil, grease and organic solvents
- Superior puncture and tear resistance
- Latex and powder-free
- 8-mil, AQL 1.5
- Accepted for use in Canadian food processing facilities
- Box Quantity: 50

**Applications:** Manufacturing, maintenance, small parts handling, laboratory, painting and janitorial



Model No.	Size	Price /Each
SDL990	X-Small	12.50
SEK261	Small	12.50
SEK262	Medium	12.50
SEK263	Large	12.50
SEK264	X-Large	12.50
SEK265	2X-Large	13.95

## N-DEX® 7500PF NITRILE GLOVES

- 100% Nitrile
- Rolled cuff prevents dirt from entering the glove
- Second-skin feel significantly reduces hand fatigue
- Reduced risk of allergies
- Thickness: 4-mil
- Powder-Free
- Accepted for use in Canadian Food Processing Facilities/Not for Medical Use
- Box Quantity: 100



Model No.	Mfg. No.	Size	Price /Each
SGC456	7500PF-S	Small	15.90
SGC457	7500PF-M	Medium	15.90
SGC458	7500PF-L	Large	15.90
SGC459	7500PF-XL	X-Large	15.90

## BLACK NITRILE GLOVES

- Pure 100% premium nitrile
- Features textured fingertips
- Exceptional tactile sensitivity
- Beaded cuff for added strength
- Protects against oil, grease and organic solvents
- Superior puncture resistance
- Latex and powder free
- Ambidextrous design
- Not for medical use
- Thickness: 5-mil
- AQL: 1.5
- Accepted for use in Canadian food processing facilities
- Box Quantity: 100

**Applications:** Manufacturing, maintenance, small parts handling, laboratory, painting and janitorial



Model No.	Size	Price /Each
SEB085	Small	14.50
SEB086	Medium	14.50
SEB087	Large	14.50
SEB088	X-Large	14.50
SED981	2X-Large	15.95

## TOUCHNTUFF® GLOVES

- Nitrile with smooth fingertips
- Contains absolutely no fillers, silicones or plasticizers
- Provide three times the puncture resistance of competitive latex or vinyl gloves
- Durable yet soft for improved comfort
- Smooth fingertips for exceptional grip
- Powder-free • Rolled cuff
- 5-mil • AQL 1.5
- Accepted for use in Canadian food processing facilities
- Box Quantity: 100

**Applications:** Manufacturing, maintenance and cleanup, intricate parts handling, laboratory analysis/technical work



Model No.	Size	Price /Each
<b>92-600 SMOOTH FINGERTIPS</b>		
SAW927	Small	21.00
SAW928	Medium	21.00
SAW929	Large	21.00
SAW930	X-Large	21.00
<b>92-675 TEXTURED FINGERTIPS</b>		
SAW937	Small	18.90
SAW938	Medium	18.90
SAW939	Large	18.90
SAW940	X-Large	18.90



## N-DEX® NIGHTHAWK™ GLOVES

- Textured fingertips
- Patented accelerator-free nitrile formulation
- Low-modulus comfort and feel
- Static-dissipative properties (ESD)
- Powder free
- 4-mil • 9" length • AQL 1.5
- Colour: Black
- Box Quantity: 50

**Applications:** Automotive, electronic assembly, laboratory, law-enforcement and security environments



Model No.	Mfg. No.	Size	Price /Each
SAL084	7700PFTS	Small	14.80
SAL085	7700PFTM	Medium	14.80
SAL086	7700PFTL	Large	14.80
SAL087	7700PFTXL	X-Large	14.80

## MEDICAL GRADE DISPOSABLE GLOVES

- Superior puncture resistance
- Protects against oil, grease and organic solvents
- Exceptional tactile sensitivity
- Textured fingertips provide superior wet and dry grip
- Certified under ASTM D6978-05 for permeation resistance to chemotherapy drugs as well as ASTM D3619 for medical testing, diagnosis and treatment
- Passed testing for resistance to Fentanyl
- Material: Nitrile
- AQL 1.5
- Length: 9.5"
- Finish: Textured Fingertips
- Cuff Style: Rolled
- Powder-Free
- Accepted for use in Canadian Food Processing Facilities
- Medical Device Class: Class 2
- Box Quantity: 100



Model No.	Size	Price /Each
<b>3.5-MIL, BLUE</b>		
SGP854	Small	6.95
SGP855	Medium	6.95
SGP856	Large	6.95
SGP857	X-Large	6.95
SGP858	2X-Large	7.95
<b>4.5-MIL, BLUE</b>		
SGP771	X-Small	7.95
SGP772	Small	7.95
SGP773	Medium	7.95
SGP774	Large	7.95
SGP775	X-Large	7.95
SGP776	2X-Large	8.75
<b>5-MIL, BLACK</b>		
SGP777	Small	8.75
SGP778	Medium	8.75
SGP779	Large	8.75
SGP780	X-Large	8.75
SGP781	2X-Large	9.50
<b>6-MIL, BLACK</b>		
SHC340	Small	9.95
SHC341	Medium	9.95
SHC342	Large	9.95
SHC343	X-Large	9.95
SHC344	2X-Large	9.95



SGP771



SGP777

## N-DEX® PLUS 8005 INDUSTRIAL GRADE GLOVES

- N-Dex®'s low-modulus formulation reduces hand fatigue caused by elastomeric stress
- Provides much greater puncture resistance than natural rubber and vinyl disposables
- Available in both lightly powdered, USP vegetable starch and powder-free styles
- Acceptable for food and pharmaceutical applications
- Extremely puncture resistant, once violated N-Dex® gloves readily tear so the wearer knows the glove should be replaced
- Accepted for use in Canadian food processing facilities
- 100% nitrile glove
- Made of FDA compliant materials
- Ambidextrous
- Not intended for medical use
- 8-mil
- 9.5" length
- AQL 4.0
- Powder-free
- Box Quantity: 100



Model No.	Mfg. No.	Size	Price /Each
SAK070	8005PF-S	Small	21.60
SAK071	8005PF-M	Medium	21.60
SAK072	8005PF-L	Large	21.60
SAK073	8005PF-XL	X-Large	21.60

## PURPLE NITRILE™ EXAM GLOVES

- Latex-free
- Powder-free
- Textured fingertips
- Ambidextrous
- Beaded cuff
- Thickness: 6-mil
- AQL 1.0
- Approval/Certification(s): Class 2 Medical Device

SAQ782



## KIMTECH™

Model No.	Mfg. No.	Size	Qty /Box	Price /Each
<b>9.5" LENGTH</b>				
SAQ782	55080	X-Small	100	45.60
SAQ783	55081	Small	100	45.60
SAQ784	55082	Medium	100	45.60
SAQ785	55083	Large	100	45.60
SAQ786	55084	X-Large	90	45.60
<b>12" LENGTH</b>				
SAQ787	55090	X-Small	50	40.10
SAQ788	50601	Small	50	40.10
SAQ789	50602	Medium	50	40.10
SAQ790	50603	Large	50	40.10
SAQ791	50604	X-Large	50	40.10

## 93-260 CHEMICAL RESISTANT DISPOSABLE GLOVE

- Three layer design for superior protection against harsh chemicals including acids, solvents and bases
- Thin mil construction provides enhanced tactility and dexterity
- Extra soft material and ergonomic design for outstanding fit, feel and flexibility for longer wear time
- Lower acceptable pinhole rate (0.65 AQL) and extended cuff for reliable protection against hazardous substances
- Silicone free formulation and processing ensure better product protection
- Ambidextrous with a beaded cuff
- Thickness: 7.8-mil
- Box Quantity: 50

## MICROFLEX®

Model No.	Mfg. No.	Size	Price /Each
SGB967	93260060	X-Small	25.50
SGB968	93260070	Small	25.50
SGB969	93260080	Medium	25.50
SGB970	93260090	Large	25.50
SGB971	93260100	X-Large	25.50
SGB972	93260110	2X-Large	25.50



## XCEED® XC-310 EXAMINATION GLOVES

- Designed with Ergoform™ Technology to support musculoskeletal health and increase worker productivity
- Thin mil design for exceptional tactile sensitivity
- Strong formulation prevents against rips and tears
- Better than industry-standard 0.65 AQL for allowable pinholes means exceptional barrier integrity and peace of mind
- Material: Nitrile
- Length: 9.5"
- Thickness: 4.3-mil
- Finish: Textured Fingertips
- Powder-Free
- Medical Device Class: Class 2

## MICROFLEX®

Model No.	Mfg. No.	Size	Gloves /Box	Price /Each
SGL278	XC-310-XS	X-Small	250	34.10
SGL279	XC-310-S	Small	250	34.10
SGL280	XC-310-M	Medium	250	34.10
SGL281	XC-310-L	Large	250	34.10
SGL282	XC-310-XL	X-Large	230	34.10



# HAND PROTECTION

## MEDICAL GRADE NITRILE/ VINYL DISPOSABLE GLOVES

- Blend of premium nitrile and vinyl
- Strength and durability of nitrile with the comfort and affordability of vinyl
- Exceptional tactile sensitivity
- Ambidextrous design
- Length: 9.5"
- Thickness: 4.5-mil
- Finish: Untextured
- Colour: Blue
- Powder-Free
- Medical Device Class: Class 2
- Box Quantity: 100

**Applications:** Manufacturing, maintenance, small parts handling, laboratory, painting and janitorial



**ZENITH**  
Safety Products

Model No.	Size	Price /Each
SGX019	Small	5.50
SGX020	Medium	5.50
SGX021	Large	5.50
SGX022	X-Large	5.50

## MEDICAL GRADE CLEAR VINYL GLOVES

- Exceptional fingertip sensitivity
- Soft and stretchable for comfortable wear
- Beaded cuff for added strength
- Ambidextrous design
- Material: Vinyl
- Length: 9.5"
- Thickness: 4.5-mil
- Finish: Untextured
- Colour: Clear
- Powder-Free
- Medical Device Class: Class 2
- Box Quantity: 100



**ZENITH**  
Safety Products

Model No.	Size	Price /Each
SGX027	Small	4.25
SGX028	Medium	4.25
SGX029	Large	4.25
SGX030	X-Large	4.25

## G10 KRAKEN GRIP DISPOSABLE GLOVES

- Fully textured on the palm and fingers with tire tread-like texture that channels oil, grease and solvents away from the areas of the hand where grip is most critical
- Provides powder-free moisture control on the inside for user comfort
- Guards against some accidental splashes, and features a 6-mil thickness on fingers and palm for both comfort and protection
- Beaded cuffs prevent roll-down and help alleviate concerns of contamination, making them a protective glove for sensitive tasks
- Material: Nitrile
- Length: 9.5"
- Thickness: 6-mil
- Powder-Free
- Finish: Fully Textured
- Accepted for use in Canadian food processing facilities
- Box Quantity: 100



**KLEENGUARD**

Model No.	Mfg. No.	Size	Price /Each
SGQ533	49275	Small	49.10
SGQ534	49276	Medium	49.10
SGQ535	49277	Large	49.10
SGQ536	49278	X-Large	49.10
SGQ537	49279	2X-Large	49.10

## ULTRAFORM® UF-524 EXAMINATION GLOVES

- Designed with Ergoform™ Technology to support musculoskeletal health and increase worker productivity
- Thin design for superior tactile sensitivity
- Soft nitrile formulation forms to hands for comfort during extended wear
- Length: 9.1"
- Thickness: 2.4-mil
- Finish: Textured Fingertips
- Powder-Free
- Medical Device Class: Class 2



**MICROFLEX**

Model No.	Mfg. No.	Size	Gloves /Box	Price /Each
SGL273	UF-524-XS	X-Small	300	36.60
SGL274	UF-524-S	Small	300	36.60
SGL275	UF-524-M	Medium	300	36.60
SGL276	UF-524-L	Large	300	36.60
SGL277	UF-524-XL	X-Large	250	36.60

## SUPRENO® SE SU-690 EXAMINATION GLOVES

- Durable nitrile formulation for demanding jobs
- Sturdy design for longer wear times
- Exceptional barrier integrity with 0.65 AQL for allowable pinholes
- Textured fingers for a strong, efficient grip
- Polymer coating assures easy donning
- Material: Nitrile
- Length: 9.1"
- Thickness: 7.1-mil
- Finish: Textured Fingertips
- Colour: Blue
- Powder-Free
- Accepted for use in Canadian Food Processing Facilities
- Medical Device Class: Class 2
- Box Quantity: 100



**MICROFLEX**

Model No.	Mfg. No.	Size	Price /Each
NJU609	SU-690-XS	X-Small	22.10
NJU607	SU-690-S	Small	22.10
NJU606	SU-690-M	Medium	22.10
NJU605	SU-690-L	Large	22.10
NJU608	SU-690-XL	X-Large	22.10

## G10 2PRO™ GLOVES

- These powder-free, ambidextrous, touchscreen compatible gloves meet U.S. FDA regulations for food contact applications and are not made with natural rubber latex
- Textured fingertips give users dexterity and control when performing delicate tasks and come in a variety of sizes (extra-small, small, medium, large and extra-large)
- Beaded cuffs prevent roll-down and help alleviate concerns of contamination and allow for superior donning
- G10 2PRO™ Blue gloves can be recycled via the Kimberly Clark Professional RightCycle™ Program
- Material: Nitrile
- Length: 9.5"
- Thickness: 6-mil
- Colour: Blue
- Medical Device Class: Non-Medical
- Box Quantity: 100



**KLEENGUARD**

Model No.	Mfg. No.	Size	Price /Each
SGX587	54420	X-Small	31.70
SGX588	54421	Small	31.70
SGX589	54422	Medium	31.70
SGX590	54423	Large	31.70
SGX591	54424	X-Large	31.70



## MEDICAL GRADE BLUE VINYL GLOVES

- Exceptional fingertip sensitivity
- Soft and stretchable for comfortable wear
- Beaded cuff for added strength
- Ambidextrous design
- Material: Vinyl
- Length: 9.5"
- Thickness: 4.5-mil
- Finish: Untextured
- Colour: Blue
- Powder-Free
- Medical Device Class: Class 2
- Box Quantity: 100



Model No.	Size	Price /Each
SGX023	Small	4.25
SGX024	Medium	4.25
SGX025	Large	4.25
SGX026	X-Large	4.25

## DISPOSABLE GLOVES

- Ideal for general purpose use and food handling
- Smooth finish for a more natural fit
- Produced without the use of DEHP
- Latex free
- Material: Vinyl
- Length: 9.5"
- Thickness: 2.8-mil
- Finish: Untextured
- Colour: Clear
- Powder-Free
- Accepted for use in Canadian Food Processing Facilities
- Medical Device Class: Non-Medical
- Standard(s) Met: EN 420:2003 + A1:2009, FDA 21 CFR 177-2600
- AQL: 4.0
- Finger Thickness: 5.1-mil
- Box Quantity: 100



## MICROFLEX®

Model No.	Mfg. No.	Size	Price /Each
SGX564	V281	Small	8.73
SGX565	V282	Medium	8.73
SGX566	V283	Large	8.73
SGX567	V284	X-Large	8.73

## DISPOSABLE GLOVES

- Strong, disposable gloves that let workers comfortably and confidently grip oily, fatty, or wet foods and objects
- Mega Texture surface provides a secure grip
- Generous fit works well with thermal undergloves while the robust design resists tearing for product protection
- Material: Nitrile
- Thickness: 8.7-mil
- Palm Thickness: 7.9-mil
- Finish: Fully Textured
- Powder-Free
- Box Quantity: 50



## MICROFLEX®

Model No.	Mfg. No.	Size	Price /Each
<b>93-283 SERIES, BLUE</b>			
SGR255	93283070	Small	22.10
SGR256	93283080	Medium	22.10
SGR257	93283090	Large	22.10
SGR258	93283100	X-Large	22.10
SGR259	93283110	2X-Large	22.10
SGR260	93283120	3X-Large	22.10
<b>93-287 SERIES, GREEN</b>			
SGR261	93287070	Small	20.40
SGR262	93287080	Medium	20.40
SGR263	93287090	Large	20.40
SGR264	93287100	X-Large	20.40
SGR265	93287110	2X-Large	20.40
SGR266	93287120	3X-Large	20.40



## EXAMINATION GRADE LATEX GLOVES

- Pure 100% premium Malaysian natural latex
- Textured surface on powder-free gloves provides superior wet and dry grip
- Exceptional tactile sensitivity
- USP grade corn starch for powdered gloves
- Beaded cuff for added strength
- Ambidextrous design
- 9.5" length, 4-mil thick • AQL 1.5
- Box Quantity: 100
- Not for medical use
- Accepted for use in Canadian food processing facilities



**Applications:** Light manufacturing, maintenance, food processing, laboratory applications and quality control

Model No.	Size	Price /Each	Model No.	Size	Price /Each
<b>POWDERED</b>			<b>POWDER-FREE</b>		
SAP338	X-Small	6.50	SAP343	X-Small	7.75
SAP339	Small	6.50	SAP344	Small	7.75
SAP340	Medium	6.50	SAP345	Medium	7.75
SAP341	Large	6.50	SAP346	Large	7.75
SAP342	X-Large	6.50	SAP347	X-Large	7.75



## EXAMINATION GRADE NITRILE GLOVES

- Pure 100% premium nitrile
- Textured surface provides superior wet and dry grip
- Exceptional tactile sensitivity
- USP grade corn starch for powdered gloves
- Beaded cuff for added strength
- Protects against oil, grease and organic solvents
- Superior puncture resistance
- Latex-free
- Ambidextrous design
- Not for medical use
- 9.5" length
- AQL 1.5



**Applications:** Manufacturing, maintenance, small parts handling, laboratory applications and automotive



Case Qty: 10 Priced per Box of 100 Gloves

Model No.	Size	Price /Each
<b>4.5-MIL, POWDERED</b>		
SEA916	X-Small	8.50
SAP320	Small	8.50
SAP321	Medium	8.50
SAP322	Large	8.50
SAP323	X-Large	8.50
SEA917	2X-Large	9.75

Case Qty: 10 Priced per Box of 100 Gloves

Model No.	Size	Price /Each
<b>4.5-MIL, POWDER-FREE</b>		
SEA918	X-Small	8.25
SAP324	Small	8.25
SAP325	Medium	8.25
SAP326	Large	8.25
SAP327	X-Large	8.25
SEA919	2X-Large	9.50

## TOUCHNTUFF® XT 69-318 GLOVES

- Textured latex • Low protein
- Contains no silicone-based materials in formulation
- Powder-free • Rolled cuff
- Natural • 5-mil • AQL 1.5
- Box Quantity: 100
- Accepted for use in Canadian food processing facilities
- Class 2 Medical Device

**Applications:** Food processing and handling, laboratory analysis/technical work, quality control, electronics assembly, light-duty maintenance and cleanup

**Caution:** This product contains natural rubber latex which may cause allergic reactions in some individuals.

## Ansell

Model No.	Size	Price /Each
SAV727	Small	17.70
SAV728	Medium	17.70
SAV729	Large	17.70
SAV730	X-Large	17.70



# HAND PROTECTION

## GRIPPAZ™ SKINS AMBIDEXTROUS DISPOSABLE GLOVES

- Patented design on the inside and outside of the glove provides extra traction with oily or wet parts
- 6-mil proprietary nitrile blend with patented fish scale pattern is more tear-resistant and puncture-resistant than conventional single-use disposable gloves – for prolonged use and reduced waste
- ESD Safe, Surface Resistance per ASTM D257, Static dissipative range at 10<sup>8</sup> ohms, 12% RH, 48 hrs @ 100 Volts
- Resistant to many chemicals commonly used in Industrial and OEM applications including oils, grease and cleaning solvents
- Proprietary nitrile blend offers enhanced flexibility, comfort and mobility – reducing hand fatigue
- Touchscreen compatible to allow the user to operate a touch screen phone or device without removing gloves
- Complies with FDA food handling requirements 21 CFR, Part 177
- Thickness: 6-mil
- Finish: Fully Textured
- Powder-Free
- Accepted for use in Canadian Food Processing Facilities
- Medical Device Class: Non-Medical
- Box Quantity: 50



Model No.	Mfg. No.	Size	Colour	Price /Each
NJC674	GP67246S	Small	Black	15.80
NJC673	GP67246M	Medium	Black	15.80
NJC672	GP67246L	Large	Black	15.80
NJC676	GP67246XL	X-Large	Black	15.80
NJC675	GP67246XXL	2X-Large	Black	15.80
SGE880	GP67256S	Small	Orange	15.80
SGE881	GP67256M	Medium	Orange	15.80
SGE882	GP67256L	Large	Orange	15.80
SGE883	GP67256XL	X-Large	Orange	15.80
SGE884	GP67256XXL	2X-Large	Orange	15.80

## DISPOSABLE POLYETHYLENE GLOVES

- Most economical glove
- Short term use
- Talc-free
- Offers mild chemical resistance
- Thin enough for fingertip sensitivity
- 1-mil, ambidextrous
- Length: 11"
- Box Quantity: 500



Model No.	Size	Price /Each
SEK352	Small	3.25
SEK353	Medium	3.25
SEK354	Large	3.25
SEK355	X-Large	3.25

## DELUXE TRIPLE GLOVES DISPENSERS

- Constructed of clear crystal acrylic
- Mounted horizontally allowing to change one box without affecting the others
- Will hold most disposable glove boxes
- Dispenser size: 20" W x 4" D x 11 13/16" H
- Gloves not included



Model No.	Mfg. No.	Description	Price /Each
SA0743	GD03DL	Deluxe triple dispenser	205.99

## BIODEGRADABLE GLOVES

- 100% nitrile with Eco Best Technology®
- Performs same as non-EBT nitrile disposable gloves
- 100% biodegradable • Decreased risk of allergies
- Zero natural rubber latex proteins
- High performance of protection • Rolled cuff
- Second skin fit and feel • Powder-Free
- Box Quantity: 100
- Accepted for use in Canadian food processing facilities



Model No.	Mfg. No.	Size	Price /Each
<b>GREEN</b>			
SFQ706	6110PFXS	X-Small	15.90
SFQ707	6110PFES	Small	15.90
SFQ708	6110PFM	Medium	15.90
SFQ709	6110PFL	Large	15.90
SFQ710	6110PFXL	X-Large	15.90
SFQ711	6110PFXXL	2X-Large	15.90
<b>BLACK</b>			
SFV254	6112PFXS	X-Small	15.90
SFV255	6112PFES	Small	15.90
SFV256	6112PFM	Medium	15.90
SFV257	6112PFL	Large	15.90
SFV258	6112PFXL	X-Large	15.90
SFV259	6112PFXXL	2X-Large	15.90

## TOUCHNTUFF® 69-210 GLOVES

- Smooth finish latex • Low protein
- Highest degree of dexterity
- Strength and comfort
- Powdered • Rolled cuff
- Natural • 5-mil • AQL 1.5
- Box Quantity: 100
- Accepted for use in Canadian food processing facilities

**Applications:** Food processing and handling, laboratory analysis/technical work, intricate parts handling, quality control, electronics assembly, light-duty maintenance and cleanup

**Caution:** This product contains natural rubber latex which may cause allergic reactions in some individuals.



Model No.	Mfg. No.	Size	Price /Each
SAY723	6921011S	Small	16.40
SAY724	6921011M	Medium	16.40
SAY725	6921011L	Large	16.40
SAY726	6921011XL	X-Large	16.40

## WALL-MOUNTED WIRE GLOVE DISPENSERS

- Designed for quick and easy glove dispensing
- Wall-mounting hardware included
- Colour: White
- Disposable glove boxes sold separately



Model No.	Description	Overall Depth"	Overall Width"	Overall Height"	Price /Each
SGC541	Holds a single box	4	11	3	8.75
SGC542	Holds two boxes	4	11	10-3/4	15.70
SGV361	Holds three boxes	4	11	14	21.95

## CANNER'S GLOVES

- Embossed diamond pattern provides superior grip
- Chlorinated for easy donning
- Applications: Food processing, plant maintenance and janitorial applications
- Length: 12"
- Thickness: 18-mil
- Cuff Style: Straight
- Shell Material: Latex
- Inner Lining: Unlined



SHF701



Model No.	Size	Price /Each
SHF701	8	1.50
SHF702	9	1.50
SHF703	10	1.50

## GREEN GLOVES

- Silicone-free
- Raised diamond pattern provides superior grip
- Resistant to cuts, puncture and abrasion
- Accepted for use in Canadian food processing facilities
- Applications: Food processing, plant maintenance, chemical processing, automotive and printing
- Cuff Style: Straight



SHF678



Model No.	Size	Length	Thickness	Shell Material	Inner Lining	Price /Each
SHF678	7	13"	11-mil	Nitrile	Unlined	1.75
SHF680	9	13"	11-mil	Nitrile	Unlined	1.75
SHF681	10	13"	11-mil	Nitrile	Unlined	1.75
SHF682	11	13"	11-mil	Nitrile	Unlined	1.75
SHF671	8	12"	15-mil	Latex	Flock-Lined	1.15
SHF683	7	13"	15-mil	Nitrile	Flock-Lined	1.80
SHF684	8	13"	15-mil	Nitrile	Flock-Lined	1.80
SHF685	9	13"	15-mil	Nitrile	Flock-Lined	1.80
SHF686	10	13"	15-mil	Nitrile	Flock-Lined	1.80
SHF687	11	13"	15-mil	Nitrile	Flock-Lined	1.80
SHF696	7	12"	20-mil	Neoprene	Flock-Lined	2.75
SHF693	8	13"	22-mil	Nitrile	Unlined	6.95
SHF694	9	13"	22-mil	Nitrile	Unlined	6.95
SHF695	10	13"	22-mil	Nitrile	Unlined	6.95

## ORANGE GLOVES

- Cotton flock lining provides increased comfort
- Diamond pattern on palm provides better grip on wet or dry surfaces
- Provides increased puncture/cut protection and tensile strength against chemical and physical hazards
- Applications: Chemical processing, petroleum refineries, plant maintenance, heavy equipment assembly and clean-up
- Cuff Style: Straight
- Inner Lining: Flock-Lined



SHF705



Model No.	Size	Length	Thickness	Shell Material	Price /Each
SHF699	10	12"	20-mil	Neoprene	2.75
SHF704	7	13"	28-mil	Latex	2.15
SHF705	8	13"	28-mil	Latex	2.15
SHF707	10	13"	28-mil	Latex	2.15

## CHEMICAL-RESISTANT GLOVES

- Silicone-free
- Embossed diamond pattern provides superior grip
- Chlorinated for easy donning
- Applications: Food processing, plant maintenance and janitorial applications
- Cuff Style: Straight



SHF670



Model No.	Size	Length"	Thickness	Shell Material	Inner Lining	Price /Each
SHF679	8	13	11-mil	Nitrile	Unlined	1.75
SCG928	6	12	15-mil	Rubber Latex	Flock-Lined	1.45
SHF670	7	12	15-mil	Latex	Flock-Lined	1.15
SHF672	9	12	15-mil	Latex	Flock-Lined	1.15
SHF673	10	12	15-mil	Latex	Flock-Lined	1.15
SHF700	7	12	18-mil	Latex	Unlined	1.50
SHF674	7	12	18-mil	Latex	Flock-Lined	1.35
SHF675	8	12	18-mil	Latex	Flock-Lined	1.35
SHF676	9	12	18-mil	Latex	Flock-Lined	1.35
SHF677	10	12	18-mil	Latex	Flock-Lined	1.35
SHF697	8	12	20-mil	Neoprene	Flock-Lined	2.75
SHF698	9	12	20-mil	Neoprene	Flock-Lined	2.75
SHF706	9	13	28-mi	Latex	Flock-Lined	2.15

## EXAMINATION GRADE GLOVES

- Pure 100% premium nitrile
- Textured surface provides superior wet and dry grip
- Exceptional tactile sensitivity
- USP grade corn starch for powdered gloves
- Beaded cuff for added strength
- Protects against oil, grease and organic solvents
- Superior puncture resistance
- Latex-free
- Ambidextrous design
- 9.5" length
- Not for medical use
- Accepted for use in Canadian food processing facilities
- Applications: Manufacturing, maintenance, small parts handling, laboratory applications and automotive
- Material: Nitrile
- Length: 9.5"
- Thickness: 4.5-mil
- Finish: Fully Textured
- Colour: Blue
- Approval/Certification(s): Accepted for use in Canadian Food Processing Facilities
- Medical Device Class: Non-Medical
- AQL: 1.5
- Case Quantity: 10 Boxes
- Cuff Style: Beaded
- Grade: AQL 1.5



SAP320



Model No.	Size	Powdered/Powder-Free	Price /Each
SEA916	X-Small	Powdered	8.50
SAP320	Small	Powdered	8.50
SAP321	Medium	Powdered	8.50
SAP322	Large	Powdered	8.50
SAP323	X-Large	Powdered	8.50
SEA917	2X-Large	Powdered	9.75
SEA918	X-Small	Powder-Free	8.25
SAP324	Small	Powder-Free	8.25
SAP325	Medium	Powder-Free	8.25
SAP326	Large	Powder-Free	8.25
SAP327	X-Large	Powder-Free	8.25
SEA919	2X-Large	Powder-Free	9.50



# HAND PROTECTION

## ZM100 MECHANIC GLOVES

- Ergonomic style and superior comfort
- Hook and loop cuff permits an adjustable fit
- Synthetic leather palm and fingers offer superior tactility and protection
- Improved dexterity, grip and durability

**Applications:** Automotive, small parts handling, maintenance, manufacturing, most industrial applications



SEB048

Model No.	Size	Price/Each
SEB047	Medium	10.75
SEB048	Large	10.75
SEB049	X-Large	10.75
SEB050	2X-Large	10.75

## ZM200 MECHANIC GLOVES

- Ergonomic style combined with stylish look
- Hook and loop cuff permits an adjustable fit
- Synthetic leather palm and fingers offer superior tactility and protection
- Stretchable nylon on knuckles improves dexterity and comfort
- Textured patches on palm and thumb permits superior grip and durability

**Applications:** Automotive, small parts handling, maintenance, manufacturing, most industrial applications



SEB052



Model No.	Size	Price/Each
SEB051	Medium	17.50
SEB052	Large	17.50
SEB053	X-Large	17.50
SEB054	2X-Large	17.50

## ZM300 MECHANIC GLOVES

- Ergonomic style and superior comfort
- Grain cowhide leather palm and fingers improve tactility and protection
- Hook and loop cuff permits an adjustable fit
- Leather reinforced thumb and fingers offer increased durability
- Improved dexterity and grip

**Applications:** Automotive, small parts handling, maintenance, manufacturing, most industrial applications



SEB229

Model No.	Size	Price/Each
SEB228	Medium	19.95
SEB229	Large	19.95
SEB230	X-Large	19.95
SEB231	2X-Large	21.75

## ZM400 PREMIUM MECHANIC GLOVES

- Ergonomic style combined with stylish look and premium features
- Hook and loop cuff permits an adjustable and secure fit
- Reinforced Kevlar® stitching for maximum strength and durability
- PVC dots on palm and fingers for an enhanced grip
- Stretchable nylon on knuckles improves dexterity and comfort
- Ventilation holes between fingers for maximum breathability
- Textured patches on palm, finger tips and thumb croch increase protection and durability

**Applications:** Automotive, small parts handling, maintenance, manufacturing, most industrial applications



Model No.	Size	Price/Each
SEH739	Medium	23.95
SEH740	Large	23.95
SEH741	X-Large	23.95
SEH742	2X-Large	23.95

## ZM500 HI-VIZ CUT RESISTANT MECHANIC GLOVES

- Reinforced full palm HPPE liner that meets EN388 cut level 5
- Hi-viz yellow spandex back for maximum visibility
- Terry towel thumb for wiping perspiration
- Textured patches on palm, finger tips and thumb croch increase protection and durability
- Ergonomic style combined with stylish look and premium features
- Hook and loop cuff permits an adjustable and secure fit

**Applications:** Automotive, small parts handling, maintenance, manufacturing, petrochemical and most industrial applications



SDP434

Model No.	Size	Price/Each
SDP433	Medium	31.95
SDP434	Large	31.95
SDP435	X-Large	31.95
SDP436	2X-Large	31.95

## MEN'S UTILITY GLOVES

- All purpose glove with unlimited household and shop uses
- Easy entry, elastic cuff designed with TPR (Thermal Plastic Rubber) hook and loop closure provides a secure fit
- Two-way form fitting Spandex top increases ventilation, comfort and fit
- Interior seam stitching prevents snagging
- Reinforced Dura-Fit™ synthetic leather thumb, index and middle fingertips provide strength and protection
- Dura-Fit™ synthetic palm offers maximum durability and breathes like leather
- Lycra™ panels between fingers add comfort and ventilation
- Colour: Black



SAN720

Model No.	Mfg. No.	Size	Price/Each
SAN720	H15-05-008	Small	26.90
SAN721	H15-05-009	Medium	26.90
SAN722	H15-05-010	Large	26.90
SAN723	H15-05-011	X-Large	26.90

## FASTFIT® WORK GLOVES

- Form-fitting TrekDry® material keeps working hands cool and comfortable
- Stretch-elastic cuff provides a secure fit to the wrist
- Reinforced thumb and index finger provide added durability
- Anatomically designed two-piece palm design eliminates material bunching
- Pinched fingertip construction improves fingertip stretch and durability
- High-dexterity 0.6mm synthetic leather provides optimal dexterity
- Touchscreen capable synthetic leather keeps you connected while you work
- Abrasion Resistance: EN 388 Level 2
- Cut Resistance: EN 388 Level 1
- Tearing Strength: EN 388 Level 2
- Puncture Resistance: EN 388 Level 1
- Palm Material: Synthetic
- Colour: Brown



Model No.	Mfg. No.	Size	Price/Each
SGS128	MFF-07-008	8	23.90
SGS129	MFF-07-009	9	23.90
SGS130	MFF-07-010	10	23.90
SGS131	MFF-07-011	11	23.90
SGS132	MFF-07-012	12	23.90



## ORIGINAL GLOVES

- New and improved fingertip design
- Ultra-thin molded TPR (thermal plastic rubber) hook and loop cuff closure
- Easy-entry, elastic cuff
- Two-way, form-fitting stretch Spandex top
- Index finger knuckle reinforcement band
- Lycra® insert panels between fingers
- Smooth surface thumb and index finger
- Tapered Clarino® synthetic leather on index, middle and ring fingertips
- Long-life Clarino® synthetic leather palm
- Concealed interior seam stitching
- Easy-on, easy-off pull-tab



SAN421

Size	Blue Model No.	Mfg. No.	Black Model No.	Mfg. No.	Price /Each
X-Small	-	-	SAN421	MG-05-007	33.90
Small	SAN895	MG-03-08	SAN422	MG-05-008	33.90
Medium	SAN896	MG-03-09	SAN423	MG-05-009	33.90
Large	SAN897	MG-03-10	SAN424	MG-05-010	33.90
X-Large	SAN898	MG-03-11	SAN425	MG-05-011	33.90
2X-Large	SAN899	MG-03-12	SAN497	MG-05-012	33.90

## HEAVY-DUTY GLOVES

- Two-way, stretch Spandex top increases ventilation, comfort and fit
- Anatomically-designed TPR (thermal plastic rubber) moulded rib panels offer flexible protection for back of hand and fingers
- Genuine professional-grade leather palm and fingertips offer the finest in comfort and protection
- Lightly padded palm reduces bulk for increased grip and control
- Palm-pattern guards side of hand against wear and abrasion
- Stretch Lycra® panels between fingers add comfort and ventilation
- Spyder-patterned leather surface provides superior grip under all working conditions
- Moulded TPR (Thermal Plastic Rubber) cuff tab with hook and loop closures provides secure
- Elastic cuff increases comfort
- Padded knuckle provides maximum flexibility and protection fit



SAP852

Model No.	Mfg. No.	Size	Price /Each
SAP852	CG40-75-008	Small	60.10
SAP853	CG40-75-009	Medium	60.10
SAP854	CG40-75-010	Large	60.10
SAP855	CG40-75-011	X-Large	60.10
NKB671	CG40-75-012	2X-Large	60.10

## FASTFIT® GLOVES

- Elastic cuff provides easy on/off flexibility
- Durable and dexterous synthetic leather palm
- TrekDry® material top helps keep hands dry and comfortable
- TPR (Thermal Plastic Rubber) hook and loop closure for a secure fit to the wrist
- Machine washable



SAR882

Size	Black Model No.	Mfg. No.	Blue Model No.	Mfg. No.	Red Model No.	Mfg. No.	High-Visibility Orange Model No.	Mfg. No.	Price /Each
Small	SAR878	MFF-05-008	SAR873	MFF-03-008	SAR868	MFF-02-008	SAR882	MFF-09-008	23.90
Medium	SAR879	MFF-05-009	SAR874	MFF-03-009	SAR869	MFF-02-009	SAR883	MFF-09-009	23.90
Large	SAR857	MFF-05-010	SAR875	MFF-03-010	SAR870	MFF-02-010	SAR884	MFF-09-010	23.90
X-Large	SAR880	MFF-05-011	SAR876	MFF-03-011	SAR871	MFF-02-011	SAR885	MFF-09-011	23.90
2X-Large	SAR881	MFF-05-012	SAR877	MFF-03-012	SAR872	MFF-02-012	SAR886	MFF-09-012	23.90

## FASTFIT® HIGH-VISIBILITY WORK GLOVES

- Form-fitting, breathable TrekDry® material keeps hands cool and comfortable
- Reflective ink on fluorescent material creates eye-catching luminance
- Reinforced thumb and index finger support for added durability
- Anatomically designed two-piece palm eliminates material bunching
- Pinched fingertip construction improves fingertip strength and durability
- High-dexterity synthetic leather infused with touchscreen technology
- Stretch-elastic cuff creates a secure fit
- Tearing Strength Rating: EN 388 Level 2
- Puncture Resistance: EN 388 Level 1
- Abrasion Resistance: EN 388 Level 2
- Cut Resistance: EN 388 Level 1
- Palm Material: Synthetic
- Machine washable
- Colour: High Visibility Yellow



SGS486

Model No.	Mfg. No.	Size	Price /Each
SGS486	SFF-91-008	Small	23.90
NKB683	SFF-91-009	Medium	23.90
NKB684	SFF-91-010	Large	23.90
NKB685	SFF-91-011	X-Large	23.90
SGS487	SFF-91-012	2X-Large	23.90

# HAND PROTECTION

## PROFLEX® 710 HEAVY-DUTY UTILITY GLOVES

- Padded palm with Tena-Grip™ reinforcement
- Tena-Grip™-reinforced fingertips and thumb saddle
- Technical hex-stretch knit construction
- Neoprene knuckle pad
- Low-profile molded hook and loop closure with ID space
- Pull-on tab for easy on/off
- EN 388: 3132

**Applications:** Heavy duty work, construction, framing/carpentry, roofing, mechanics, service techs, tool/machine operation



SFQ458

Model No.	Mfg. No.	Size	Price /Each
SFQ458	17042	Small	52.30
SFQ459	17043	Medium	52.30
SFQ460	17044	Large	52.30
SFQ461	17045	X-Large	52.30
SFQ462	17046	2X-Large	52.30

## PROFLEX® REINFORCED THERMAL WATERPROOF UTILITY GLOVES

- Dual-zone 3M™ Thinsulate™ Insulation
- Waterproof/windproof breathable membrane insert
- Weather-resistant ripstop outer shell + DWR finish
- Rugged AX Suede™ palm + touch screen capabilities
- Extended neoprene cuff with hook & loop closure
- Palm Material: Suede
- Lining: Thinsulate™
- Cuff Material: Neoprene
- Cuff Style: Safety



Model No.	Mfg. No.	Size	Price /Each
SFU620	17372	Small	56.60
SFU621	17373	Medium	56.60
SFU622	17374	Large	56.60
SFU623	17375	X-Large	56.60
SFU624	17376	2X-Large	56.60

## PROFLEX® 710CR HEAVY-DUTY AND CUT RESISTANCE GLOVES

- Armortex®-backed palm for enhanced cut protection
- Padded palm with Tena-Grip™ reinforcement
- Technical hex-stretch knit construction
- Neoprene knuckle pad
- Low-profile molded hook and loop closure with ID space
- Pull-on tab for easy on/off
- EN 388: 4544 D; ANSI/ASTM Cut A4

**Applications:** Heavy duty work, construction, assembly/fabrication, sheet metal, sharp edge material handling, electrical, pulp & paper, mechanics' service techs, tool/machine operation



SFM485

Model No.	Mfg. No.	Size	Price /Each
SFM485	17122	Small	35.70
SFM486	17123	Medium	35.70
SFM487	17124	Large	35.70
SFM488	17125	X-Large	35.70
SFM489	17126	2X-Large	35.70

## PROFLEX® 816 THERMAL FLIP-TOP GLOVES

- Fleece-lined mitten converts to half-finger gloves
- Mitten pocket and thumb stow easily when not in use
- Weather-resistant outer shell
- Durable synthetic leather palm
- Contoured gathered elastic cuff w/ ID space
- Soft thumb nose/brow wipe area
- Reflective accents
- Certifications: EN 388: 3423 X



SFU610

Model No.	Mfg. No.	Size	Price /Each
SFU610	17342	Small	54.10
SFU611	17343	Medium	54.10
SFU612	17344	Large	54.10
SFU613	17345	X-Large	54.10
SFU614	17346	2X-Large	54.10

## PROFLEX® 815 QUICKCUFF™ UTILITY GLOVES

- Durable synthetic leather palm
- Reinforced thumb saddle wear area
- Breathable poly mesh construction
- QuickCuff™ elastic gauntlet fit with ID space
- Pull-on tab for easy on/off
- Certification(s): EN 388: 2121

**Applications:** General work, warehousing/distribution, light assembly/fabrication, service techs, landscaping, maintenance, freight/baggage



SFQ468

Model No.	Mfg. No.	Size	Price /Each
SFQ468	17202	Small	28.80
SFQ469	17203	Medium	28.80
SFQ470	17204	Large	28.80
SFQ471	17205	X-Large	28.80
SFQ472	17206	2X-Large	28.80

## PROFLEX® 817 REINFORCED THERMAL UTILITY GLOVES

- Dual-zone 3M™ Thinsulate™ Insulation
- Weather-resistant ripstop outer shell + DWR finish
- Rugged AX Suede™ palm and fingertip reinforcements
- Touch screen capable thumb and index finger
- Extended neoprene cuff with hook and loop closure and ID space
- Neoprene knuckle pad
- Soft thumb nose/brow wipe area
- Reflective accents
- Certifications: EN 388: 3423 X



SFU615

Model No.	Mfg. No.	Size	Price /Each
SFU615	17352	Small	53.10
SFU616	17353	Medium	53.10
SFU617	17354	Large	53.10
SFU618	17355	X-Large	53.10
SFU619	17356	2X-Large	53.10



## PROFLEX® 818WP PERFORMANCE THERMAL WATERPROOF UTILITY GLOVES

- Dual-zone 3M™ Thinsulate™ Insulation
- Waterproof/windproof breathable membrane insert
- Weather-resistant ripstop outer shell + DWR finish
- Tough Tena-Grip™ palm + touch screen capabilities
- Extended neoprene cuff with hook and loop closure and ID space
- Neoprene knuckle pad
- Soft thumb nose/brow wipe area
- Reflective accents
- Certifications: EN 388: 3423 X



Black Model No.	Mfg. No.	Orange Model No.	Mfg. No.	Size	Price /Each
SFU625	17382	SFU630	17392	Small	75.80
SFU626	17383	SFU631	17393	Medium	75.80
SFU627	17384	SFU632	17394	Large	75.80
SFU628	17385	SFU633	17395	X-Large	75.80
SFU629	17386	SFU634	17396	2X-Large	75.80

## PROFLEX® 819WP EXTREME THERMAL WATERPROOF GLOVES

- Dual-zone 3M™ Thinsulate™ Insulation
- Waterproof/windproof breathable membrane insert
- Weather-resistant ripstop outer shell + DWR finish
- Gauntlet cuff with internal elastic cinch cord
- Rugged AX Suede™ palm and fingertip reinforcements
- Touchscreen capable thumb and index finger
- Neoprene knuckle pad
- Soft thumb nose/brow wipe area
- Reflective accents
- Certifications: EN388: 4222 B



SFU635



Model No.	Mfg. No.	Size	Price /Each
SFU635	17612	Small	77.90
SFU636	17613	Medium	77.90
SFU637	17614	Large	77.90
SFU638	17615	X-Large	77.90
SFU639	17616	2X-Large	77.90

## COLDWORK™ ORIGINAL® GLOVES

- Thermoplastic Rubber (TPR) closure creates a secure fit
- Heavyweight fleece construction
- Water-resistant softshell back of hand
- C40 3M™ Thinsulate™ insulation traps warm air
- Touchscreen capable synthetic leather
- Machine washable
- Palm Material: Synthetic
- Lining: Thinsulate™
- Colour: Black & Grey

SGV181



Model No.	Mfg. No.	Size	Price /Each
SGV181	CWKMG-58-008	Small	41.80
SGV182	CWKMG-58-009	Medium	41.80
SGV183	CWKMG-58-010	Large	41.80
SGV184	CWKMG-58-011	X-Large	41.80
SGV185	CWKMG-58-012	2X-Large	41.80



## DURAHIDE™ LEATHER SERIES



### THE ORIGINAL® GLOVES

- Flexible TPR closure provides a secure fit to the wrist
- Form-fitting TrekDry® material keeps your hands cool and comfortable while you work
- Double-stitched index finger and thumb reinforcement
- Pinched fingertip construction improves fingertip strength
- DuraHide™ leather fourchettes improve finger durability
- DuraHide™ leather palm provides extreme abrasion resistance



SFU691

Model No.	Mfg. No.	Size	Price /Each
SFU691	LMG-75-008	Small	44.00
SFU692	LMG-75-019	Medium	44.00
SFU693	LMG-75-010	Large	44.00
SFU694	LMG-75-011	X-Large	44.00
SFU695	LMG-75-012	2X-Large	44.00

### FASTFIT® GLOVES

- Comfortable stretch elastic cuff provides easy on and off flexibility
- Form-fitting TrekDry® material keeps your hands cool and comfortable while you work
- DuraHide™ leather thumb reinforcement
- Pinched fingertip construction improves fingertip strength
- Anatomically designed two-piece palm eliminates material bunching in the palm
- DuraHide™ leather palm provides extreme abrasion resistance



SFU696

Model No.	Mfg. No.	Size	Price /Each
SFU696	LFF-75-008	Small	38.60
SFU697	LFF-75-009	Medium	38.60
SFU698	LFF-75-010	Large	38.60
SFU699	LFF-75-011	X-Large	38.60
SFU700	LFF-75-012	2X-Large	38.60

### M-PACT® GLOVES

- Flexible TPR closure provides a secure fit to the wrist
- Form-fitting TrekDry® material keeps your hands cool and comfortable while you work
- Double-stitched index finger and thumb reinforcement
- Pinched fingertip construction improves fingertip strength
- DuraHide™ leather fourchettes improve finger durability
- DuraHide™ leather palm provides extreme abrasion resistance



SFU701

Model No.	Mfg. No.	Size	Price /Each
SFU701	LMP-75-008	Small	57.90
SFU702	LMP-75-009	Medium	57.90
SFU703	LMP-75-010	Large	57.90
SFU704	LMP-75-011	X-Large	57.90
SFU705	LMP-75-012	2X-Large	57.90

## SQUIDS® GRABBERS

- Easy to use with a comfortable feel
  - Keeps gloves close at hand
  - Clips to clothing, belts, tool belts and D-rings
  - Breakaway feature
  - Dielectric/non-conductive material
- Applications:** Carpentry, electrician, contractors, trades, roofing, construction, warehousing, maintenance, mechanics, HVAC, plumbing, mitten security



SAO182

Model No.	Mfg. No.	Colour	Price /Each
-----------	----------	--------	-------------

Model No.	Mfg. No.	Colour	Price /Each
<b>GRABBERS</b>			
SAO180	19112	Black	4.89
SAO181	19117	Blue	4.89
SAO182	19118	Orange	4.89
SAO183	19119	Yellow	4.89
<b>GRABBERS W/BELT CLIP</b>			
SAO184	19122	Black	4.89
SAO185	19127	Blue	4.89
SAO186	19128	Orange	4.89
SAO187	19129	Yellow	4.89



SAO184



# HAND PROTECTION

## IMPACT & CUT RESISTANT GLOVES

- Economical ribbed mat offering efficient performance
- Excellent option for small businesses
- Cuff Style: Driver
- Palm Material: Goatskin
- Cut Resistance Rating: ASTM ANSI Level 5
- Impact resistance: ANSI/ISEA 138 Level 2



Model No.	Size	Price /Each
SGW905	Small	26.50
SGW906	Medium	26.50
SGW907	Large	26.50

Model No.	Size	Price /Each
SGW908	X-Large	26.50
SHG527	2X-Large	26.50
SHG528	3X-Large	26.50



## M-PACT® GLOVES

- Molded Thermal Plastic Rubber (TPR) provides impact protection to the fingers and knuckles
- Poron® XRD™ palm padding absorbs shock and vibration
- Form-fitting TrekDry® top material helps keep hands dry and comfortable
- Rubberized grip material on the thumb and index finger provides durable gripping power
- TPR hook and loop closure for a secure fit to the wrist
- Machine washable



SED998

SFU793

Priced per Pair

Size	Model No. Black/Grey	Mfg. No.	Model No. Red	Mfg. No.	Model No. Covert Black	Mfg. No.	Model No. Black/Grey Slip-On Cuff	Mfg. No.	Price /Each
Small	SED998	MPT-58-008	SEE003	MPT-52-008	SEE013	MPT-55-008	SFU793	MPC-58-08	46.80
Medium	SED999	MPT-58-009	SEE004	MPT-52-009	SEE014	MPT-55-009	SFU794	MPC-58-09	46.80
Large	SEE000	MPT-58-010	SEE005	MPT-52-010	SEE015	MPT-55-010	SFU795	MPC-58-10	46.80
X-Large	SEE001	MPT-58-011	SEE006	MPT-52-011	SEE016	MPT-55-011	SFU796	MPC-58-11	46.80
2X-Large	SEE002	MPT-58-012	SEE007	MPT-52-012	SEE017	MPT-55-012	SFU797	MPC-58-12	46.80

## M-PACT® 2 HEAVY-DUTY IMPACT GLOVES

- Designed to trap water and dirt out of your building
- An affordable solution for small businesses
- Cuff Style: Hook & Loop
- Palm Material: Synthetic
- Colour: High Visibility Yellow & Black
- Abrasion Resistance: EN 388 Level 2
- Cut Resistance: EN 388 Level 1
- Tearing Strength Rating: EN 388 Level 1
- Puncture Resistance: EN 388 Level 1



Model No.	Mfg. No.	Size	Price /Each
SGS520	SP2-91-008	Small (8)	52.80
SGS521	SP2-91-009	Medium (9)	52.80
NKB686	SP2-91-010	Large (10)	52.80
SGS522	SP2-91-011	X-Large (10)	52.80
SGS523	SP2-91-012	2X-Large (12)	52.80



## CR5 M-PACT® CUT RESISTANT GLOVES

- Impact Guard™ protects first knuckle with EVA foam padding
- Thermal Plastic Rubber (TPR) knuckle guard and pinch-point finger protection
- ANSI-107 compliant TrekDry® material helps keep hands cool and comfortable
- Synthetic palm with an internal layer of Armortex® delivers CE level 5 cut resistance
- XRD® palm padding absorbs impact and vibration
- Embossed and textured index and thumb provide grip



Model No.	Mfg. No.	Size	Price /Each
SFU966	SMP-C91-008	Small (8)	59.00
SFU967	SMP-C91-009	Medium (9)	59.00
SFU968	SMP-C91-010	Large (10)	59.00
SFU969	SMP-C91-011	X-Large (11)	59.00
SFU970	SMP-C91-012	2X-Large (12)	59.00



## M-PACT® MULTICAM TACTICAL IMPACT GLOVES

- Designed to trap water and dirt out of your building
- An affordable solution for small businesses
- Cuff Style: Hook & Loop
- Palm Material: Synthetic
- Abrasion Resistance: EN 388 Level 3
- Cut Resistance: EN 388 Level 1
- Tearing Strength: EN 388 Level 2
- Puncture Resistance: EN 388 Level 1
- Impact Protection: EN 388 Level P



Model No.	Mfg. No.	Size	Price /Each
SGS272	MPT-78-008	Small (8)	46.80
SGS273	MPT-78-009	Medium (9)	46.80
SGS274	MPT-78-010	Large (10)	46.80
SGS275	MPT-78-011	X-Large (11)	46.80
SGS276	MPT-78-012	2X-Large (12)	46.80



## HI-VIZ M-PACT® D4-360 IMPACT GLOVES

- Fluorescent TrekDry® material keeps working hands cool and comfortable
- Reflective ink creates eye-catching luminance
- Thermoplastic Rubber (TPR) closure creates a secure fit to your wrist
- Armortex® palm reinforcement provides added durability
- High-tensile strength liner provides 360° protection
- D30® palm padding absorbs impact and vibration
- Touchscreen capable synthetic leather keeps you connected while you work
- Cuff Style: Hook & Loop
- Palm Material: Synthetic
- Certification(s): ANSI/ISEA 138
- Abrasion Resistance: EN 388 Level 3
- Tearing Strength: EN 388 Level 4
- Puncture Resistance: EN 388 Level 3
- Cut Resistance: EN 388 Level D
- Impact Protection: EN 388 Level P
- Machine washable



Model No.	Mfg. No.	Size	Price /Each
SGR790	SMP-X91-008	8	66.50
SGR791	SMP-X91-009	9	66.50
SGR792	SMP-X91-010	10	66.50
SGR793	SMP-X91-011	11	66.50
SGR794	SMP-X91-012	12	66.50

SGR790



## M-PACT® DRIVER F9-360 IMPACT GLOVES

- DuraHide™ leather and high-tensile strength fibre lining delivers 360° protection
- Features Thermoplastic Rubber (TPR) knuckle, metacarpal, and pinch-point fingertip guards
- Gunn cut finger design repositions vulnerable seams for improved durability
- Liner: DuraHide™
- Certification(s): ANSI/ISEA 138
- Abrasion Resistance: EN 388 Level 4
- Tearing Strength: EN 388 Level 4
- Puncture Resistance: EN 388 Level 3
- Impact Protection: EN 388 Level P
- Cut Resistance: ASTM ANSI Level A9, EN 388 Level F



Model No.	Mfg. No.	Size	Price /Each
SGR770	LDMP-C75-008	8	72.90
SGR771	LDMP-C75-009	9	72.90
SGR772	LDMP-C75-010	10	72.90
SGR773	LDMP-C75-011	11	72.90
SGR774	LDMP-C75-012	12	72.90

SGR770



## PREMIUM IMPACT & REPETITIVE STRAIN PROTECTIVE GLOVES

- Fingerless glove provides excellent protection in applications where constant impact or vibration is a concern
- Visco-elastic polymer (VEP) palm and thumb crotch padding absorbs and dissipates shock
- Detachable leather wrist support for wrist repetitive strain protection
- Nylon Lycra® with grain leather palm for abrasion resistance in applications where it will be used on its own
- Ideal for heavy industrial use, jackhammer, grinding and impact tool applications.

SR263



Model No. Right	Mfg. No.	Model No. Left	Mfg. No.	Size	Price /Each
SR263	704-20XS-R	SR268	704-20XS-L	X-Small	42.30
SR264	704-20S-R	SR269	704-20S-L	Small	42.30
SR265	704-20M-R	SR270	704-20M-L	Medium	42.30
SR266	704-20L-R	SR271	704-20L-L	Large	42.30
SR267	704-20XL-R	SR272	704-20XL-L	X-Large	42.30

## ANTI-IMPACT GLOVE LINERS

- Fingerless four-way stretch poly/cotton lycra glove makes an excellent liner for leather work gloves
- Visco-elastic polymer (VEP) full palm padding absorbs and dissipates shock
- Split leather palm for abrasion resistance in applications where it will be used on its own
- Ideal for general assembly and material handling applications

SR208



SR196



Model No. Right	Mfg. No.	Model No. Left	Mfg. No.	Size	Price /Each
<b>GLOVE LINER</b>					
SR191	501-00XS-R	SR196	501-00XS-L	X-Small	16.70
SR192	501-00S-R	SR197	501-00S-L	Small	16.70
SR193	501-00M-R	SR198	501-00M-L	Medium	16.70
SR194	501-00L-R	SR199	501-00L-L	Large	16.70
SR195	501-00XL-R	SR200	501-00XL-L	X-Large	16.70
<b>SPLIT LEATHER PALM</b>					
SR203	501-10XS-R	SR208	501-10XS-L	X-Small	17.80
SR204	501-10S-R	SR209	501-10S-L	Small	17.80
SR205	501-10M-R	SR210	501-10M-L	Medium	17.80
SR206	501-10L-R	SR211	501-10L-L	Large	17.80
SR207	501-10XL-R	SR212	501-10XL-L	X-Large	17.80

## BACK TRACKER BLADE GLOVE

- Ideal for work with sharp materials and tools such as glass handling and metal manufacturing
- TPR pads on back of fingers, thumb, and back of the hand help prevent finger pinching, abrasions, and crushing injuries
- Elastic nylon laminated fabric with cut resistant weaving protects the entire hand from laceration injuries
- Anti-slip, nitrile dipped palm offers excellent gripping and abrasion protection
- Reinforced patches in the thumb web area assure long wear
- Palm Material: Nitrile
- Cuff Style: Hook & Loop
- Meets ANSI/ISEA 105:2016 cut resistance level A5 and EN 388:2016, 420:2003 & A1:2009

SGQ893



Model No.	Mfg. No.	Size	Price /Each
SGQ893	NS2920020	7	38.70
SGQ894	NS2920030	8	38.70
SGQ895	NS2920040	9	38.70
SGQ896	NS2920050	10	38.70
SGQ897	NS2920060	11	38.70

## BLACKMAXX VIBRATION DAMPENING GLOVES

- Economical vibration dampening gloves coated with "pods" of lightweight cellular chloroprene
- Uses encapsulated air to cushion and dampen vibration, giving the user good dexterity, a lightweight feel and reduced bunching
- 60% kevlar, 40% cotton seamless knit
- 7 gauge liner to incorporate excellent protection from slash injuries



Model No.	Mfg. No.	Size	Price /Each
SED170	4731	Medium	28.60
SED171	4732	Large	28.60
SED172	4733	X-Large	28.60





# HAND PROTECTION

## LINED GRAIN COWHIDE FITTERS GLOVES

- Cotton-lined palm keeps hands dry
- Resist oil and water absorption better than split leather
- Superior abrasion resistance
- Excellent comfort and durability
- Rubberized cuff
- Gunn cut pattern with wing thumb style
- Full leather-tipped fingers and knuckle strap provide increased protection

**Applications:** Material handling, fabrication, metal handling and construction



SM583



Model No.	Description	Size	Case Qty	Price /Each
SAS502	Standard Quality	Ladies	120	4.95
SM582	Standard Quality	Medium	120	5.05
SAJ023	Standard Quality	Large	120	5.20
SAP232	Standard Quality	X-Large	60	5.95
SM583	Standard Quality, 4" Gauntlet Cuff	Large	120	5.75
SAP223	Double Palm & Index, Premium Quality	Large	120	10.50
SAP233	Premium Quality	Large	120	7.65



SAP223

## GRAIN COWHIDE FITTERS STANDARD QUALITY GLOVES

- Superior abrasion resistance
- Excellent comfort and durability
- Resists oil and water absorption better than split leather
- Rubberized safety cuff
- Gunn cut pattern with wing thumb style
- Full leather-tipped fingers and knuckle strap

**Applications:** Material handling, fabrication, metal handling and construction



SEK242



Model No.	Description	Size	Price /Each
SEK239	High Visibility Green	Large	8.50
SEK242	High Visibility Orange	Large	8.50



SEK239

## STANDARD QUALITY UNLINED GRAIN COWHIDE FITTERS GLOVES

- Unlined palm for improved dexterity and sensitivity
- Resist oil and water absorption better than split leather
- Superior abrasion resistance
- Excellent comfort and durability
- Rubberized cuff
- Gunn cut pattern with wing thumb style
- Full leather-tipped fingers and knuckle strap provide increased protection

**Applications:** Material handling, fabrication, metal handling and construction



SA619



Model No.	Size	Price /Each
SEC139	Ladies	4.95
SEB100	Medium	5.05
SA619	Large	5.20
SEB101	X-Large	5.75
SEB102	X-Large	5.95



SEC139

## GRAIN COWHIDE FURNITURE LEATHER GLOVES

- Standard quality
- Durable construction
- Resists oil and water
- Cotton-lined patch palm style
- Starched safety cuff
- Gunn cut pattern with wing thumb style
- Smooth grain leather finish

**Applications:** Material handling, fabrication, metal handling and construction



Model No.	Size	Price /Each
SAN270	Large	3.95

## STANDARD QUALITY GRAIN COWHIDE LEATHER GLOVES

- Superior abrasion resistance
- Unlined, full grain cowhide palm and index finger
- Full split leather 4" gauntlet cuff
- Gunn cut pattern with wing thumb style

**Applications:** Material handling, fabrication, metal handling and construction



SI842



Model No.	Description	Size	Price /Each
SI842	Split Back	Large	7.05
SDP097	Split Back	X-Large	7.35
SDP098	Split Back	2X-Large	8.35
SM592	Grain Cowhide Back	Large	9.10



SM592

## GRAIN COWHIDE PATCH PALM FITTERS GLOVES

- Smooth grain cowhide leather construction
- Superior abrasion resistance
- Excellent comfort and durability
- Absorbent cotton-lined palm
- Resists oil and water absorption better than split leather
- Patch palm design delivers added savings
- Gunn cut pattern with wing thumb style
- Full leather-tipped fingers and knuckle strap provide increased protection

**Applications:** Material handling, fabrication, metal handling and construction



YC386



Model No.	Description	Size	Price /Each
YC386	Standard Quality, Plasticized Cuff	Large	4.85
SECS94	Standard Quality, 4 3/4" Gauntlet Cuff	Large	5.25
SAP230	Standard Quality, Rubberized Cuff	X-Large	5.30
SAP234	Premium Quality, Rubberized Cuff	X-Large	7.15

## GRAIN COWHIDE DRIVERS GLOVES

- Standard quality
- Excellent comfort, durability and dexterity
- Oil and water resistant
- Smooth leather finish
- Unlined palm
- Gunn cut pattern with keystone thumb style
- Provides a snug fit and a good sense of touch

**Applications:** Forklift and truck driver use, construction and farm equipment handling

Model No.	Description	Size	Price /Each
SG0763	Standard Quality	X-Small	6.60
SM584	Standard Quality	Small	7.00
SM585	Standard Quality	Medium	7.10
SM586	Standard Quality	Large	7.55
SM587	Standard Quality	X-Large	7.90
SGJ101	Standard Quality	2X-Large	8.20
SFV191	Premium Quality	Small	7.90
SFV192	Premium Quality	Medium	8.20
SFV193	Premium Quality	Large	8.50
SFV194	Premium Quality	X-Large	8.85



ZENITH®  
Safety Products

## DRIVER'S GLOVES

- Premium quality goat grain leather provides excellent dexterity and exceptional comfort
- Keystone thumb and elastic wrist band ensure a comfortable fit
- Smooth leather finish
- Leather Palm Type: Grain Goatskin
- Thumb Style: Keystone
- Cuff Style: Hemmed

**Applications:** Forklift and truck driver use, construction and farm equipment handling



Model No.	Size	Price /Each
SGW785	Small	8.10
SGW786	Medium	8.40
SGW787	Large	8.75
SGW788	X-Large	9.10

ZENITH®  
Safety Products

## GRAIN COWHIDE ROPERS GLOVES

- Standard quality
- Oil and water resistant
- Excellent comfort, durability and dexterity
- Snug fit and good sense of touch
- Ropers' style comes with adjustable strap with snap
- Smooth leather finish

**Applications:** Forklift and truck driver use, construction and farm equipment operators

Model No.	Description	Size	Price /Each
SM588	Standard Quality	Small	9.75
SM589	Standard Quality	Medium	9.80
SM590	Standard Quality	Large	9.95
SM591	Standard Quality	X-Large	9.95
SFV183	Premium Quality	Small	9.90
SFV184	Premium Quality	Medium	9.95
SFV185	Premium Quality	Large	10.15
SFV186	Premium Quality	X-Large	10.35



ZENITH®  
Safety Products

## SPLIT COWHIDE FITTERS GLOVES

- Grade: Premium quality
- Top split leather cowhide construction
- Good abrasion resistance
- Absorbent cotton-lined palm
- Full leather-tipped fingers and knuckle strap
- Launderable PE cuff on order SAP226
- Gunn cut pattern with wing thumb style
- SEI496 is sewn with DuPont® Kevlar® stitching for added seam strength and durability

**Applications:** Material handling, fabrication, metal handling and construction



SAP298

SAP227

ZENITH®  
Safety Products

## STANDARD QUALITY DOUBLE PALM SPLIT COWHIDE FITTERS GLOVE

- Double layer of leather for premium protection
- Ultimate abrasion resistance
- Absorbent cotton-lined palm
- Rubberized safety cuff
- Gunn cut pattern with wing thumb style
- Full leather-tipped fingers and knuckle strap

**Applications:** Heavy-duty material handling, fabrication and metal handling



SM578

SD604

SE349

SM579

Model No.	Description	Size	Case Qty	Price /Each
SM578	Outside Double Palm & Index Finger	Large	120	4.60
SM579	Outside Double Palm & Index Finger, 4" Gauntlet Cuff	Large	72	4.95
SD604	Outside Double Palm, Index Finger & Finger Tips	Large	60	6.49
SE349	Inside Double Palm & Index Finger	Large	120	4.40

ZENITH®  
Safety Products

Model No.	Description	Size	Case Qty	Price /Each
SAS503	Rubberized Cuff	Ladies	120	3.80
SG281	Rubberized Cuff	Medium	120	3.75
SD602	Rubberized Cuff	Large	120	4.00
SD603	Rubberized Cuff	X-Large	120	4.25
SAP229	Rubberized Cuff	2X-Large	60	4.45
SAP298	Rubberized 4" Gauntlet Cuff	Large	72	4.55
SAP227	Solid colour cotton and rubberized cuff	Large	120	4.50
SAP226	PE Cuff	Large	120	4.10
SEI496	Rubber cuff, Kevlar, Blue	Large	120	4.95

Stay safe & work confidently with ZENITH®  
Safety Products



# HAND PROTECTION

## STANDARD QUALITY SPLIT COWHIDE LEATHER GLOVES

- Top split cowhide leather construction
- Good abrasion resistance
- Unlined palm
- Gunn cut pattern with wing thumb style
- Full split leather cuff

**Applications:** Material handling, fabrication, metal handling and construction



SAL592



Model No.	Description	Size	Price /Each
SAL592	2" Cuff	Large	4.45
SAL253	4" Cuff	Large	4.60

## SPLIT COWHIDE PATCH PALM FITTERS GLOVES

- Good abrasion resistance
- Absorbent cotton-lined palm
- Patch palm design
- Starched safety cuff
- Gunn cut pattern with wing thumb style
- Full leather-tipped fingers and knuckle straps

**Applications:** Material handling, fabrication, metal handling and construction



SAN636



SAP225



SAN382



Model No.	Description	Size	Price /Each
SAN636	Standard Quality, Denim Cuff	Large	2.90
SAN382	Standard Quality, Striped Cuff	Large	3.00
SAP231	Standard Quality, Striped Cuff	X-Large	3.10
SAP225	Premium Quality, Striped Cuff	Large	3.60

## PREMIUM QUALITY HI VIZ SPLIT COWHIDE FITTERS GLOVES

- Good abrasion resistance
- Absorbent cotton-lined palm
- Full leather-tipped fingers and knuckle strap
- Two gray reflective stripes offer maximum visibility
- Gunn cut pattern with wing thumb style
- Rubberized safety cuff



SEK236

SED160



Model No.	Colour	Size	Price /Each
SED160	Fluorescent Yellow	Large	4.95
SEK236	Fluorescent Orange	Large	4.95

## SPLIT COWHIDE LEATHER PALM GLOVES

- Rugged split cowhide leather construction
- Good abrasion resistance
- Cotton back provides superior breathability
- Clute cut pattern with straight thumb style
- Knit wrist

**Applications:** Material handling, automotive, assembly and construction



SM572



SM573



SAP297



SAP296



Model No.	Description	Size	Price /Each
SM572	Standard Quality, White Back, Patch Palm	Large	2.05
SN266	Standard Quality, White Back	Ladies	2.15
SAP274	Standard Quality, White Back	Medium	2.15
SA616	Standard Quality, White Back	Large	2.15
SAP294	Standard Quality, White Back	X-Large	2.20
SM573	Standard Quality, White Back, Full Index Finger	Large	2.40
SAP297	Standard Quality, Striped Back	Large	2.25
SAP296	Premium Quality, White Back	Large	2.25

## SPLIT COWHIDE FITTERS GLOVES

- Good abrasion resistance
- Absorbent cotton-lined palm
- Starched safety cuff
- Gunn cut pattern with wing thumb style
- Full leather-tipped fingers and knuckle strap

**Applications:** Material handling, fabrication, metal handling and construction



SAP224



SM576



SM575



Model No.	Description	Size	Case Qty	Price /Each
SM575	Standard Quality	Large	120	3.45
SAP228	Standard Quality	X-Large	72	3.60
SM576	Standard Quality, 4" Gauntlet Cuff	Large	120	3.65
SAP224	Premium Quality	Large	120	3.80



## SPLIT BACK DRIVERS GRAIN PALM GLOVES

- Standard quality
- Grain leather provides excellent dexterity and abrasion resistance
- Unlined palm with a split leather back
- Gunn-cut design with keystone thumb and elastic back
- Ideal for use in construction, machine operation utility work, and many other general applications

Model No.	Size	Price /Each
SAJ651	Small	6.20
SAJ652	Medium	6.45
SAJ653	Large	6.55
SAJ654	X-Large	6.95



SAJ651

## SPLIT PIGSKIN FITTERS GLOVES

- Standard quality
- Good abrasion resistance and dexterity
- Superior comfort and breathability
- Performs better than cowhide grain or split leather in wet applications
- Absorbent cotton-lined palm
- Starched safety cuff
- Gunn cut pattern with wing thumb style
- Full leather-tipped fingers and knuckle strap

**Applications:** Material handling, fabrication and construction

Model No.	Size	Price /Each
SAO156	Large	3.80
SAP353	X-Large	4.45



SAO156

## HPPE LINED SPLIT COWHIDE CUT RESISTANT GLOVES

- Seamless fitted 10-gauge HPPE liner
- Made out of extremely strong fibres of HPPE (high performance polyethylene)
- Superior cut, abrasion and tear resistance
- Sewn with Twaron® thread for higher seam strength and resistance
- Rubberized safety cuff
- Full leather-tipped fingers and knuckle strap
- Meets ASTM ANSI Level A6 for cut resistance
- EN 388 Performance Levels: 4X44F

Model No.	Size	Price /Each
SDN114	Large (9)	15.50
SDN162	X-Large (10)	15.50



SDN114

## SPLIT BACK PREMIUM QUALITY GRAIN COWHIDE LEATHER GLOVES

- Superior abrasion resistance
- Unlined, full grain cowhide palm
- Full split leather 4" gauntlet cuff
- Kevlar® stitching improves seam strength and reduces seam burnout
- Gunn cut pattern with wing thumb style

**Applications:** Material handling, fabrication, metal handling and construction

Model No.	Size	Price /Each
SFV121	Small	8.60
SFV122	Medium	9.25
SFV123	Large	9.95
SFV124	X-Large	10.25



SFV121

## DRIVER'S WORK GLOVES

- Comfortable stretch-elastic cuffs provide easy on and off flexibility
- Durahide™ DRY™ leather is water resistant yet breathable, and ready to work with no break-in time
- The Gunn cut finger design repositions vulnerable seams for improved durability
- Comfortable keystone thumb design
- Leather Palm Type: Grain Cowhide



Model No.	Mfg. No.	Size	Price /Each
SHB674	LDCW-75-008	8	34.30
SHB675	LDCW-75-009	9	34.30
SHB676	LDCW-75-010	10	34.30
SHB677	LDCW-75-011	11	34.30
SHB678	LDCW-75-012	12	34.30



SHB674

## GRAIN PIGSKIN FITTERS GLOVES

- Good abrasion resistance and dexterity
- Superior comfort and breathability
- Performs better than cowhide grain or split leather in wet applications
- Starched safety cuff
- Gunn cut pattern with wing thumb style
- Full leather-tipped fingers and knuckle strap

**Applications:** Material handling, fabrication and construction



SM580

Model No.	Description	Size	Price /Each
<b>STANDARD QUALITY</b>			
SM580	Cotton-Lined Palm	Large	5.75
SDP099	Unlined Palm	Large	5.70
SDP100	Unlined Palm	X-Large	6.15
<b>PREMIUM QUALITY</b>			
SAP222	Cotton-Lined Palm, Rubberized Cuff	Large	6.75



SAP222

## HYD-TUF® GLOVES

- Driver's style, with cloth back and soft jersey lining
- Medium to heavy-duty nitrile coated
- Outperform standard cotton and leather gloves
- Nitrile coating resists snags, punctures, abrasions and cuts
- Excellent dry grip and repelling oil, grease and grime
- Snug and comfortable fit
- Safety cuff
- Accepted for use in Canadian food processing facilities



Model No.	Size	Price /Each
SAW956	9	6.67
SAW957	10	6.67



SAW956

# HAND PROTECTION

## STANDARD QUALITY GRAIN COWHIDE LEATHER GLOVES

- Standard quality cow grain palm and index leather
- Top split cowhide leather back and cuff construction
- Hook and loop tab for adjustable fit
- 5" cuff provides superior protection
- Gunn cut pattern with wing thumb style
- Exceptional durability



SEE287



Model No.	Size	Price /Each
SEE287	Small	9.35
SEE288	Medium	10.20
SEE289	Large	10.80
SEE290	X-Large	11.40
SEE291	2X-Large	12.25

## STANDARD QUALITY GOAT GRAIN GLOVES

- Standard quality goat grain palm and index leather
- Top split goatskin leather back and cuff construction
- Hook and loop tab for adjustable fit
- 5" cuff provides superior protection
- Gunn cut pattern with wing thumb style
- Exceptional dexterity



SEB734



Model No.	Size	Price /Each
SEB752	Small	10.65
SEB733	Medium	11.20
SEB734	Large	11.65
SEB735	X-Large	12.15
SEB736	2X-Large	13.10

## GRAIN COWHIDE FURNITURE LEATHER COTTON FLEECE-LINED GLOVES

- Standard quality
- Full cotton fleece lining provides moderate warmth
- Resists oil and water
- Durable, tough furniture leather construction
- Patch palm & safety cuff provides added protection
- Gunn cut pattern with wing thumb style
- Smooth grain leather finish

**Applications:** Material handling, fabrication, metal handling and construction.



Model No.	Size	Price /Each
SEA198	Large	4.95

## GRAIN FURNITURE LEATHER FITTERS ACRYLIC BOA-LINED GLOVES

- Standard quality
- Excellent abrasion resistance
- Provides superior warmth
- Resists oil and water well
- Patch palm design
- Starched safety cuff
- Full leather-tipped fingers and knuckle strap
- Gunn cut pattern with wing thumb style
- Smooth grain leather finish

**Applications:** Extreme cold material handling, fabrication, metal handling and construction.



SAP290



Model No.	Size	Price /Each
SAP290	Large	6.95
SDL886	X-Large	7.20
SDL887	2X-Large	7.60

## GRAIN COWHIDE FITTERS ACRYLIC BOA-LINED GLOVES

- Provides superior warmth
- Superior abrasion resistance
- Excellent comfort and durability
- Resists oil and water well
- Gunn cut pattern with wing thumb style
- Full leather-tipped fingers and knuckle strap

**Applications:** Extreme cold material handling, fabrication, metal handling and construction.



SDL883



Model No.	Description	Size	Price /Each
SEI681	Standard Quality Rubberized Safety Cuff, Patch Palm	Large	7.65
SA0053	Premium Quality Rubberized Safety Cuff	Large	9.89
SDL882	Premium Quality Rubberized Safety Cuff	X-Large	10.40
SDL883	Premium Quality Rubberized Safety Cuff	2X-Large	10.90

## PREMIUM QUALITY HI-VIZ GRAIN COWHIDE FITTERS THINSULATE™-LINED GLOVES

- Premium construction, superior quality
- 100-g Thinsulate™ liner provides superior warmth
- Superior abrasion resistance
- Excellent comfort and durability
- Resists oil and water well
- Full leather-tipped fingers and knuckle strap
- Two gray reflective stripes offer maximum visibility
- Gunn cut pattern with wing thumb style
- Rubberized safety cuff



SED428



Model No.	Colour	Size	Price /Each
SED428	Fluorescent Yellow	Large	12.20
SEK237	Fluorescent Orange	Large	12.20

## THINSULATE™ LINED GRAIN COWHIDE FITTERS GLOVES

- Provides superior warmth
- Superior abrasion resistance
- Excellent comfort and durability
- Provides good dexterity
- Resists oil and water well
- Gunn cut pattern with wing thumb style
- Full leather-tipped fingers and knuckle strap

**Applications:** Extreme cold material handling, fabrication, metal handling and construction.



Model No.	Description	Size	Price /Each
SASS01	Premium Quality, 100-g Thinsulate™	Ladies	10.55
SM613	Premium Quality, 100-g Thinsulate™	Large	11.05
SEH040	Standard Quality, 100-g Thinsulate™	Large	9.55
SAP246	Premium Quality, 100-g Thinsulate™	X-Large	11.45
SDL885	Premium Quality, 100-g Thinsulate™	2X-Large	12.85
SEI642	Standard Quality, Patch Palm, 40-g Thinsulate™	Large	8.40

## GOAT GRAIN STANDARD QUALITY FLEECE-LINED GLOVES

- Standard quality goat grain palm and index leather
- Split cowhide leather back and cuff construction
- Hook and loop tab for adjustable fit
- 5" cuff provides superior protection
- Exceptional dexterity
- Gunn cut pattern with wing thumb style
- Palm and back cotton fleece liner provides added warmth

SEE313



Model No.	Size	Price /Each
SEE313	Medium	13.55
SEE314	Large	13.80
SEE315	X-Large	16.05



## SPLIT COWHIDE FITTERS FULL COTTON FLEECE-LINED GLOVES

- Standard quality
- Good abrasion resistance
- Safety cuff
- Gunn cut pattern with wing thumb style
- Full leather-tipped fingers and knuckle strap

**Applications:** Moderate cold material handling, fabrication, metal handling and construction



SD613

Model No.	Size	Price /Each
SD613	Large	5.85
SAP299	X-Large	6.05



## GRAIN COWHIDE DRIVERS & ROPERS FLEECE-LINED GLOVES

- Superior abrasion resistance
- Resists oil and water well
- Excellent comfort and durability
- Provides moderate warmth
- Drivers' style comes with elastic wrist
- Ropers' style comes with adjustable strap with snap

**Applications:** Forklift and truck drivers, operators of construction and farm equipment.



SAP250

Model No.	Description	Size	Price /Each
<b>STANDARD QUALITY</b>			
SM616	Drivers	Small	8.30
SM617	Drivers	Medium	8.50
SM618	Drivers	Large	8.75
SM619	Drivers	X-Large	9.10
SAP250	Drivers	2X-Large	9.80
SAP215	Ropers	Small	10.30
SAP216	Ropers	Medium	10.80
SAP217	Ropers	Large	11.30
SAP218	Ropers	X-Large	11.90
<b>PREMIUM QUALITY</b>			
SFV195	Drivers	Small	10.10
SFV196	Drivers	Medium	10.20
SFV197	Drivers	Large	11.10
SFV198	Drivers	X-Large	11.40
SFV187	Ropers	Small	11.80
SFV188	Ropers	Medium	12.00
SFV189	Ropers	Large	12.35
SFV190	Ropers	X-Large	12.70



SAP215

## SPLIT COWHIDE FITTERS FOAM FLEECE-LINED GLOVES

- Premium quality
- Provides excellent warmth
- Good abrasion resistance
- Rubberized cuff
- Gunn cut pattern with wing thumb style
- Full leather-tipped fingers and knuckle strap

**Applications:** Moderate/extreme cold material handling, fabrication, metal handling and construction



SAP241

Model No.	Size	Price /Each
SAP240	Medium	6.40
SAP241	Large	6.65
SAP242	X-Large	6.95
SDL884	2X-Large	7.25



## PREMIUM QUALITY HI-VIZ SPLIT COWHIDE FITTERS THINSULATE™-LINED GLOVES

- Good abrasion resistance
- 100-g Thinsulate™ liner provides superior warmth
- Full leather-tipped fingers and knuckle strap
- Two gray reflective stripes offer maximum visibility
- Gunn cut pattern with wing thumb style
- Rubberized safety cuff



SED161

Model No.	Colour	Size	Price /Each
SED161	Fluorescent Yellow	Large	8.70
SEK238	Fluorescent Orange	Large	8.70





# HAND PROTECTION

## THINSULATE™-LINED SPLIT COWHIDE FITTERS GLOVES

- Premium quality
- Good abrasion resistance
- Provides superior warmth
- Good dexterity
- Rubberized safety cuff
- Gunn cut pattern with wing thumb style
- Full leather-tipped fingers and knuckle strap

**Applications:** Extreme cold material handling, fabrication, metal handling and construction



Model No.	Size	Lining Weight g	Price /Each
SAS500	Ladies	100	7.80
SAN637	Medium	100	7.95
SALS44	Large	40	7.75
SM609	Large	100	8.35
SAP248	X-Large	100	8.60
SAP249	2X-Large	100	9.00

## GRAIN COWHIDE FITTERS COTTON FLEECE-LINED GLOVES

- Standard quality
- Full cotton fleece lining provides moderate warmth
- Superior abrasion resistance
- Excellent comfort and durability
- Resists oil and water absorption better than split leather
- Gunn cut pattern with wing thumb style
- Full leather-tipped fingers and knuckle strap

**Applications:** Moderate cold material handling, fabrication, metal handling and construction

SEF236



Model No.	Description	Size	Price /Each
SM610	Rubberized Safety Cuff	Ladies	7.50
SD605	Rubberized Safety Cuff	Large	7.65
SAP245	Rubberized Safety Cuff	X-Large	7.80
SEF236	Gauntlet Cuff	Large	8.20



## SPLIT COWHIDE FITTERS ACRYLIC BOA-LINED GLOVES

- Premium quality
- Provides superior warmth
- Good abrasion resistance
- Rubberized safety cuff
- Gunn cut pattern with wing thumb style
- Full leather-tipped fingers and knuckle strap provide increased protection

**Applications:** Extreme cold material handling, fabrication, metal handling and construction

SD614



Model No.	Size	Price /Each
SD614	Large	6.60
SAP247	X-Large	6.95
SDL890	2X-Large	7.35



## GRAIN COWHIDE LEATHER FLEECE-LINED GLOVES

- Standard quality construction
- Superior abrasion resistance
- Excellent comfort and durability
- Resists oil and water well
- Full leather-tipped fingers and knuckle strap
- Gunn cut pattern with wing thumb style
- 2 1/2" elastic cuff eliminates dirt and debris from entering the glove

SEB613



Model No.	Size	Price /Each
SEH145	Medium	8.15
SEB613	Large	8.35



## GRAIN COWHIDE FITTERS COTTON FLEECE-LINED PATCH PALM GLOVES

- Standard quality
- Superior abrasion resistance
- Provides moderate warmth
- Excellent comfort and durability
- Resists oil and water absorption better than split leather
- Patch palm design
- Rubberized safety cuff
- Gunn cut pattern with wing thumb style
- Full leather-tipped fingers and knuckle strap

**Applications:** Moderate cold material handling, fabrication, metal handling and construction

SR521



Model No.	Size	Price /Each
SR521	Large	6.89
SAM023	X-Large	7.15
SDL881	2X-Large	7.50



## GRAIN PIGSKIN FITTERS COTTON FLEECE-LINED GLOVES

- Standard quality
- Smooth top grain construction
- Good abrasion resistance
- Provides moderate warmth
- Superior comfort and breathability
- Good dexterity
- Performs well in wet applications
- Gunn cut pattern with wing thumb style
- Full leather-tipped fingers and knuckle strap

**Applications:** Moderate cold material handling, fabrication and construction



Model No.	Size	Price /Each
SAP295	Large	7.75



## GRAIN PIGSKIN FITTERS ACRYLIC BOA-LINED GLOVES

- Premium quality
- Good abrasion resistance
- Boa lining provides superior warmth
- Superior comfort and breathability
- Good dexterity
- Performs well in wet applications
- Full leather-tipped fingers and knuckle strap
- Gunn cut pattern with wing thumb style
- Safety cuff

**Applications:** Extreme cold material handling, fabrication and construction

SAP300



Model No.	Description	Size	Price /Each
SAP300	Superior Quality, Rubberized Cuff	Large	9.25
SDL888	Superior Quality, Rubberized Cuff	X-Large	9.70
SDL889	Superior Quality, Rubberized Cuff	2X-Large	10.20



## PREMIUM QUALITY GRAIN PIGSKIN FOAM FLEECE LINED GLOVES

- Fitter glove with shorter driver style cuff
- Premium pigskin leather construction
- Superior performance in wet applications
- Good abrasion resistance
- Full leather tipped fingers and knuckle strap
- Full red foam fleece lining provides excellent warmth

**Applications:** Moderate cold material handling, fabrication and construction



Model No.	Size	Price /Each
SDL465	Small	9.50
SDL021	Medium	9.75
SDS860	Large	9.85
SDS861	X-Large	10.00
SDN053	2X-Large	10.15



## GRAIN COWHIDE FITTERS FOAM FLEECE-LINED GLOVES

- Standard quality
- Provides excellent warmth
- Superior abrasion resistance
- Excellent comfort and durability
- Resists oil and water well
- Full leather-tipped fingers and knuckle strap
- Gunn cut pattern with wing thumb style
- Rubberized safety cuff

**Applications:** Moderate/extreme cold material handling, fabrication, metal handling and construction

SM611



Model No.	Size	Price /Each
SM611	Large	8.85
SDL891	X-Large	9.40



## BOA-LINED PREMIUM GRAIN LEATHER MITTEN

- Full boa lining provides superior warmth and comfort
- Premium grain cowhide leather has excellent abrasion resistance
- Double-shirred elastic front provides optimal fit
- Suitable for cold weather applications and environments
- Thumb Style: Wing

**Applications:** Outdoor recreational activities, railroad maintenance, material handling, equipment and heavy machinery operation, general-purpose and construction



Model No.	Size	Price /Each
SGF640	Large	14.00



## THINSULATE™-LINED GRAIN PIGSKIN FITTERS GLOVES

- Premium quality
- Good abrasion resistance
- Provides superior warmth
- Superior comfort and breathability
- Performs well in wet applications
- Good dexterity
- Full leather-tipped fingers and knuckle strap
- Rubberized safety cuff
- Gunn cut pattern with wing thumb style
- 100-g Thinsulate™ lining

**Applications:** Extreme cold material handling, fabrication and construction

SAP251



Model No.	Size	Price /Each
SM615	Large	10.45
SAP251	X-Large	10.70
SDL892	2X-Large	11.45



## BOA LINED SPLIT GRAIN WINTER MITTS

- Full boa lining provides superior warmth and comfort
- Rugged split cowhide leather construction
- Good abrasion resistance
- Grade: Premium Quality

**Applications:** Recreational activities, railroad maintenance, material handling, equipment and heavy machinery operation, general-purpose and construction



Model No.	Size	Price /Each
SGV409	One Size	6.85



# HAND PROTECTION

## FIREARMOR® STRUCTURAL FIRE GLOVES

- Structural firefighting glove made with cow suede leather
- Extended gauntlet cuff for added protection against debris
- Reinforced thumb saddle and palm for increased durability and abrasion resistance
- NFPA 1971:2018 certified H2X+™ FR moisture barrier (interior layer)
- Shell Material: Kevlar®
- Inner Lining: Nomex®
- Heat Resistance Max. Temperature: 360° F (182° C)
- Cuff Style: Gauntlet



SGX778

**HexArmor**  
the science of safety.

Model No.	Mfg. No.	Size	Price /Each
SGX778	8180-S (7)	Small	181.00
SGX779	8180-M (8)	Medium	181.00
SGX780	8180-L (9)	Large	181.00
SGX781	8180-XL (10)	X-Large	181.00
SGY239	8180-XS (6)	X-Small	209.00
SGY240	8180-XXL (11)	2X-Large	209.00
SGY241	8180-XXXL (12)	3X-Large	209.00
SGY242	8180-XXXXL (13)	4X-Large	209.00

## HOT MILL GLOVES

- Top quality heavy cotton fabric construction
- Heavy cotton-lined palm provides superior heat resistance
- SEF068 32-oz. lined palm for increased heat protection
- 4" gauntlet cuff provides extra protection

**Applications:** Forging, foundries, plastic extrusions and other operations that require heat protection



SEF067



SEF068

**ZENITH**  
Safety Products

Model No.	Heat Protection	Description	Size	Price /Each
SEF067	Up to 482°F (250°C)	24-oz. Yellow Palm	X-Large	3.30
SEF068	Up to 482°F (250°C)	32-oz. Green Palm	X-Large	3.55

## CARBO-KING™ HEAT RESISTANT GLOVES

- Patented Carbo-King™ material
- Gauntlet cuff with Kevlar® knit wrist
- Made in Canada
- Fabric Weight: 15 oz.
- Shell Material: Aramid
- Inner Lining: Melton
- Heat Resistance Max. Temperature: 2100° F (1149° C)
- Cuff Style: Gauntlet, Knit Wrist
- Length: 13"
- Flammability Resistance: EN407 Level 4
- Contact Heat Resistance: EN407 Level 4
- Convective Heat Resistance: EN407 Level 4
- Radiant Heat Resistance: EN407 Level 3

**JOMAC**  
CANADA



SGT770

Model No.	Mfg. No.	Size	Price /Each
SGT770	440CA-S	Small	115.00
SGT771	440CA-M	Medium	115.00
SGT772	440CA-L	Large	115.00
SGT773	440CA-XXL	2X-Large	115.00
SGT774	440CA-XXXL	3X-Large	115.00

## TERRY CLOTH GLOVES

- 24 oz. heavyweight terry knit fabric provides abrasion and heat resistance
- Offers excellent insulation and allows heat to disperse rapidly
- Heat protection up to 390°F (200°C)
- Absorbs liquids and perspiration for added dexterity and comfort
- Ambidextrous design
- Fabric Weight: 24 oz.
- Material: Terry Cloth
- Lining: Unlined

**Applications:** Sharp metal handling, steel manufacturing, foundries, glass handling, heat and general industrial applications



SDP089

**ZENITH**  
Safety Products

Model No.	Cuff Style	Size	Price /Each
SDP089	Slip-On	Large	1.50
SDP090	Knit Wrist	Large	1.65

## CHAR-GUARD™ HEAT-RESISTANT GLOVES

- Comfortable non-woven liner to provide flexibility and fit
- Superior tactile dexterity
- Non-slip grip
- Heat-resistant coating protects up to 500°F
- Can withstand multiple washings
- Black colour extends wearable life as it does not show dirt and grime easily
- Accepted for use in Canadian food processing facilities

**Applications:** Hot castings for intermittent heat, lab sampling with hot glassware or moldings, plastic molding, plant maintenance controls up to 500°F, food processing and service



SAP618

Model No.	Mfg. No.	Size	Length"	Price /Each
SAP618	8814-07	7	14	21.60
SAP619	8814-08	8	14	21.60
SAP620	8814-09	9	14	21.60
SAP621	8814-10	10	14	21.60

**SHOWA**

## TERRY CLOTH LINED TWARON® GLOVES

- 100% Twaron® shell with seamless terry cloth liner
- Flame and cut resistant, will not burn or melt
- Terry cloth liner provides added insulation and comfort
- Excellent protection and dexterity
- Heat protection up to 700°F (371°C)
- Fabric Weight: 32 oz.
- Lining: Terry Cloth
- Cuff Style: Gauntlet/Knit Wrist

**Applications:** Foundries, steel manufacturing, heat and general industrial applications



SDP437

**ZENITH**  
Safety Products

Model No.	Size	Price /Each
SDP437	Large	17.95



## POLY/COTTON INSPECTION GLOVES

- Keep hands clean during inspections
- Protect products from fingerprints, contamination, scratches and static
- Can be used as a perspiration absorbing liner for gloves
- Material: 48% cotton and 52% polyester blend
- SEE783, SEE784 and SHH457 are accepted for use in Canadian food processing facilities

**Applications:** General inspection lines, assembly, glove liner



Model No.	Cuff	Size	Price /Each
<b>LIGHTWEIGHT</b>			
SEE783	Unhemmed	Ladies	0.37
SEE784	Unhemmed	Men's	0.37
SHH457	Hemmed, 12"	Men's	0.75
<b>MEDIUMWEIGHT</b>			
SEE785	Hemmed	Ladies	0.52
SEE786	Hemmed	Men's	0.58
<b>MEDIUMWEIGHT</b>			
SEE789	Knit Wrist	Ladies	0.50
SEE790	Knit Wrist	Men's	0.55

## COTTON INSPECTION GLOVES

- Keep hands clean during inspections
- Protect products from fingerprints, contamination, scratches and static
- Can be used as a perspiration absorbing liner for gloves
- 100% heavyweight cotton
- Accepted for use in Canadian food processing facilities

**Applications:** General inspection lines, assembly, glove liner



Model No.	Cuff	Size	Price /Each
SEE787	Hemmed	Ladies	0.62
SEE788	Hemmed	Men's	0.67



## NYLON INSPECTION GLOVES

- Low-lint nylon yarn offers premium product protection
- Maximum dexterity and sensitivity
- Keep hands clean during inspections
- Protect products from fingerprints, contamination, scratches and static
- Hemmed cuff provides secure fit

**Applications:** Electronics inspection lines and assembly, paint line inspection and low lint applications



Model No.	Size	Price /Each
SDS931	Ladies, X-Small	0.90
SEE791	Ladies	0.95
SEE792	Men's	1.00



## PARADE/WAITER'S GLOVES

- Seaming detail on back
- 100% white cotton
- Hemmed cuff provides secure fit
- Accepted for use in Canadian food processing facilities

**Applications:** Police, waiters, funeral homes, and general inspection



Model No.	Size	Price /Each
SEE793	Small	1.45
SEE794	Medium	1.50
SEE795	Large	1.50
SEE796	X-Large	1.55



## PREMIUM STRING KNIT GLOVES

- Cotton, nylon and spandex blend
- Elastic knit wrist
- Optimal fit
- Superior comfort
- Premium dexterity and sensitivity
- Accepted for use in Canadian food processing facilities

**Applications:** Ideal for automotive assembly, material handling, parts handling, and as a glove liner



Model No.	Size	Price /Each
SED611	Small	1.10
SED612	Medium	1.10
SED613	Large	1.10



## POLY/COTTON STRING KNIT GLOVES

- Seamless string knit design provides excellent comfort and breathability
- 65% cotton and 35% polyester blend, 7 gauge
- Reversible pattern extends wear life and improves savings
- Knit wrist provides secure fit and prevents debris from entering the glove
- Accepted for use in Canadian food processing facilities

**Applications:** Parts handling, maintenance, assembly, glove liner and food processing



Model No.	Size	Price /Each	Model No.	Size	Price /Each
<b>STANDARD WEIGHT</b>			<b>HEAVYWEIGHT</b>		
SDS937	X-Small	0.42	SEE932	X-Small	0.48
SDS938	Small	0.47	SEE933	Small	0.52
SDS939	Medium	0.47	SEE934	Medium	0.53
SDS940	Large	0.52	SEE935	Large	0.58
SDS941	X-Large	0.52	SEE936	X-Large	0.63
SDS942	2X-Large	0.53	SEE937	2X-Large	0.64



# HAND PROTECTION

## POLYESTER STRING KNIT GLOVES

- Seamless string knit design provides excellent comfort and breathability
- 100% polyester
- Elastic knit wrist
- Polyester offers resistance to water absorption remaining lightweight even when wet

**Applications:** Automotive, clean rooms, assembly and parts handling, glove liner and food processing



SEF199

Model No.	Size	Gauge	Price /Each
SGD514	Small	10	0.88
SEF199	Medium	10	0.92
SEF200	Large	10	0.97
SGD515	X-Large	10	1.00
SGC361	X-Small	15	0.77
SGC362	Ladies	15	0.77
SGC363	Men's	15	0.77



## NATURAL POLY/COTTON DOTTED GLOVES

- PVC dots provide excellent grip and abrasion resistance
- 65% cotton and 35% polyester blend, 7 gauge
- Natural colour poly/cotton seamless string knit provides a cool comfortable fit
- Ambidextrous, both sides dotted version extends wear life
- **Heavyweight:** Accepted for use in Canadian food processing facilities

**Applications:** General maintenance, shipping and receiving, assembly and parts handling



SEE941



Model No.	Size	Price/Each
<b>ONE SIDE DOTTED, LIGHTWEIGHT</b>		
SDS943	X-Small	0.60
SDS944	Small	0.60
SDS945	Medium	0.66
SDS946	Large	0.66
SDS947	X-Large	0.71

Model No.	Size	Price/Each
<b>ONE SIDE DOTTED, HEAVYWEIGHT</b>		
SEE938	X-Small	0.66
SEE939	Small	0.71
SEE940	Medium	0.71
SEE941	Large	0.76
SEE942	X-Large	0.82

Model No.	Size	Price/Each
<b>BOTH SIDES DOTTED, HEAVYWEIGHT</b>		
SEE943	Small	0.83
SEE944	Medium	0.93
SEE945	Large	0.94
SEE946	X-Large	0.99

## WHITE POLY/COTTON DOTTED GLOVES

- PVC dots provide excellent grip and abrasion resistance
- Bleached white poly/cotton seamless string knit provides a cool comfortable fit
- Ambidextrous, both sides dotted version extends wear life
- Accepted for use in Canadian food processing facilities

**Applications:** General maintenance, shipping and receiving, assembly and parts handling



SAN489



SAN493



Model No.	Size	Price /Each
<b>ONE SIDE DOTTED</b>		
SAN489	Small	0.81
SAN490	Medium	0.81
SAN491	Large	0.81
SAN492	X-Large	0.86
<b>BOTH SIDES DOTTED</b>		
SAN493	Small	0.92
SAN494	Medium	0.92
SAN495	Large	0.97
SAN496	X-Large	0.97

## MULTICOLOUR POLY/COTTON DOTTED GLOVES

- PVC dots provide excellent grip and abrasion resistance
- Poly/cotton seamless string knit provides a cool comfortable fit
- Multicolour hides the dirt and extends wear life

**Applications:** General maintenance, shipping and receiving, assembly and parts handling



SAM662

Model No.	Size	Price/Each
SAM662	Small	0.66
SAM663	Large	0.66



## COTTON CANVAS DOTTED PALM GLOVES

- PVC dots provide excellent grip and abrasion resistance
- Excellent comfort, dexterity and breathability
- Moderate abrasion resistance
- Knit wrist provides secure fit and prevents debris from entering the glove

**Applications:** Material handling, automotive, assembly and construction



SEE947

Model No.	Size	Price/Each
SEE947	Small	1.25
SEE948	Large	1.25



## THERMAL GLOVE LINERS

- Keep hands warm in cold environments
- Can be used on its own or as a glove liner
- Polyester offers resistance to water absorption, remaining lightweight even when wet
- Ambidextrous
- Gauge: 13



Model No.	Size	Price /Each
SGH425	Large	5.80

## INSULATOR® 78-101/78-150 GLOVES

- Hand warmer in cold, damp working environments
- May be used as an under glove
- Ambidextrous

**Applications:** Handling chilled or refrigerated products, fishing industry, utilities, construction, general maintenance



SEA277

SEA308



Model No.	Colour	Size	Price /Each
SEA277	Blue	One Size	6.51
SEA308	White	One Size	6.51

## PVC PALM COATED GLOVES

- String knit design for excellent breathability and comfort
- PVC palm coating provides superior abrasion resistance, grip and durability
- Knit wrist eliminates dirt and debris from entering the glove
- Black on white

**Applications:** Parts handling, assembly and metal stamping



Model No.	Size	Price /Each
SAP211	Small	1.25
SAP212	Medium	1.25
SAP213	Large	1.25
SAP214	X-Large	1.25



## SALT & PEPPER JERSEY GLOVES

- Durable knit jersey fabric offers premium comfort
- 65% polyester and 35% cotton blend
- Good abrasion resistance
- Knit wrist provides secure fit and prevents debris from entering the glove

**Applications:** Light-duty material handling, assembly, automotive and winter glove liner



Model No.	Size	Price /Each
SEE951	Large	1.40
SEE952	X-Large	1.40



## COTTON CANVAS GLOVES

- Excellent comfort, dexterity and breathability
- Moderate abrasion resistance
- Knit wrist provides secure fit and prevents debris from entering the glove
- Heavier weights provide enhanced protection and extended wear

**Applications:** Material handling, automotive, assembly, construction



Model No.	Fabric Weight oz	Size	Price /Each
SEE846	7	Large	1.05
SEE847	8	Medium	1.10
SEE848	8	Large	1.10
SEE849	8	X-Large	1.10
SEE850	12	Large	1.40



## ORIGINAL SUPER GREEN KING™ GLOVES

- Unique extra heavy weight cotton fleece
- High quality fabric allows for repeated launderings with minimal colour loss
- Excellent comfort and warmth
- Snug green and white knit wrist maintains stretch even after numerous washing
- Made in Canada



Model No.	Mfg. No.	Size	Price /Each
SED899	SGK	Large	11.20



## BROWN JERSEY GLOVES

- Durable knit jersey fabric offers premium comfort
- 65% polyester and 35% cotton blend
- Good abrasion resistance
- Provides moderate warmth

**Applications:** Light-duty material handling, assembly, automotive and winter glove liner



Model No.	Description	Size	Case Qty	Price /Each
SEE949	Slip-On, Red Fleece Lining	Large	144	1.80
SEE950	Knit Wrist	Large	300	0.89



## SQUIDS® GRABBERS

- Easy to use with a comfortable feel
- Keeps gloves close at hand
- Clips to clothing, belts, tool belts and D-rings
- Breakaway feature
- Dielectric/non-conductive material

**Applications:** Carpentry, electrician, contractors, trades, roofing, construction, warehousing, maintenance, mechanics, HVAC, plumbing, mitten security

Model No.	Mfg. No.	Colour	Price /Each
<b>GRABBERS</b>			
SA0180	19112	Black	4.89
SA0181	19117	Blue	4.89
SA0182	19118	Orange	4.89
SA0183	19119	Yellow	4.89
<b>GRABBERS W/BELT CLIP</b>			
SA0184	19122	Black	4.89
SA0185	19127	Blue	4.89
SA0186	19128	Orange	4.89
SA0187	19129	Yellow	4.89



## HAND WARMERS

- Fits easily inside your pocket, mitt or gloves
- Long lasting heat
- Single use
- Qty/Pkg.: 2



Model No.	Price /Each
SG0961	1.35





# FOOT PROTECTION

## 8" MONSTER BOOTS

- Waterproof leather with breathable membrane and comfort-padded top collar
- Corrosion-resistant top hardware and catch-resistant speed lacing system
- Rubber toe guard and TPU external heel counter
- Lateral roll bars and heel cup for high-performance stability
- Insane Comfort Insole
- Dual-density polyurethane mid-sole provides insane comfort
- Anti-fatigue technology absorbs shock and returns energy
- Oil and acid-resistant rubber outsole
- Slip-resistant sole features deep lugs, multi-directional traction and durable contact zones to provide exceptional durability and traction
- Material: Leather
- Toe Type: Non-metallic Toe
- Sole Type: Plain
- Plate Type: Non-metallic
- Certification(s): CSA Green Triangle
- Waterproof: Impermeable



SGE966

Model No.	Mfg. No.	Shoe Size	Model No.	Mfg. No.	Shoe Size	Price/Each
<b>BLACK BOOTS</b>						
SGE966	MNSTMP01-BK1-7	7	SGE977	MNSTMP01-BR1-7	7	292.00
SGE967	MNSTMP01-BK1-8	8	SGE978	MNSTMP01-BR1-8	8	292.00
SGE968	MNSTMP01-BK1-8.5	8-1/2	SGE979	MNSTMP01-BR1-8.5	8-1/2	292.00
SGE969	MNSTMP01-BK1-9	9	SGE980	MNSTMP01-BR1-9	9	292.00
SGE970	MNSTMP01-BK1-9.5	9-1/2	SGE981	MNSTMP01-BR1-9.5	9-1/2	292.00
SGE971	MNSTMP01-BK1-10	10	SGE982	MNSTMP01-BR1-10	10	292.00
SGE972	MNSTMP01-BK1-10.5	10-1/2	SGE983	MNSTMP01-BR1-10.5	10-1/2	292.00
SGE973	MNSTMP01-BK1-11	11	SGE984	MNSTMP01-BR1-11	11	292.00
SGE974	MNSTMP01-BK1-12	12	SGE985	MNSTMP01-BR1-12	12	292.00
SGE975	MNSTMP01-BK1-13	13	SGE986	MNSTMP01-BR1-13	13	292.00
SGE976	MNSTMP01-BK1-14	14	SGE987	MNSTMP01-BR1-14	14	292.00
<b>BROWN BOOTS</b>						

## 6" MONSTER BOOTS

- Waterproof leather with breathable membrane and comfort-padded top collar
- Corrosion-resistant top hardware and catch-resistant speed lacing system
- Rubber toe guard and TPU external heel counter
- Lateral roll bars and heel cup for high-performance stability
- Insane Comfort Insole
- Dual density polyurethane mid-sole provides insane comfort
- Anti-fatigue technology absorbs shock and returns energy
- Oil and acid-resistant rubber outsole
- Slip-resistant sole features deep lugs, multi-directional traction and durable contact zones to provide exceptional durability and traction
- Material: Leather
- Toe Type: Non-metallic Toe
- Sole Type: Plain
- Plate Type: Non-metallic
- Certification(s): CSA Green Triangle
- Waterproof: Impermeable



SGE999

Model No.	Mfg. No.	Shoe Size	Model No.	Mfg. No.	Shoe Size	Price/Each
<b>BLACK BOOTS</b>						
SGE988	MNSTMP02-BK1-7	7	SGE999	MNSTMP02-BR1-7	7	283.00
SGE989	MNSTMP02-BK1-8	8	SGF001	MNSTMP02-BR1-8	8	283.00
SGE990	MNSTMP02-BK1-8.5	8-1/2	SGF002	MNSTMP02-BR1-8.5	8-1/2	283.00
SGE991	MNSTMP02-BK1-9	9	SGF003	MNSTMP02-BR1-9	9	283.00
SGE992	MNSTMP02-BK1-9.5	9-1/2	SGF004	MNSTMP02-BR1-9.5	9-1/2	283.00
SGE993	MNSTMP02-BK1-10	10	SGF005	MNSTMP02-BR1-10	10	283.00
SGE994	MNSTMP02-BK1-10.5	10-1/2	SGF006	MNSTMP02-BR1-10.5	10-1/2	283.00
SGE995	MNSTMP02-BK1-11	11	SGF007	MNSTMP02-BR1-11	11	283.00
SGE996	MNSTMP02-BK1-12	12	SGF008	MNSTMP02-BR1-12	12	283.00
SGE997	MNSTMP02-BK1-13	13	SGF009	MNSTMP02-BR1-13	13	283.00
SGE998	MNSTMP02-BK1-14	14	SGF010	MNSTMP02-BR1-14	14	283.00
<b>BROWN BOOTS</b>						

## 16" ECONOMY BOOTS

- Excellent underfoot protection
- Designed to provide exceptional puncture resistance
- Injected molded seamless construction
- Full steel midsole
- Replaceable cushion insoles
- Pull-ups and kick off lug for easy on and off
- Cut off band for height adjustment
- Excellent for use in orchards, construction, vegetables fields, citrus groves, and agriculture
- Steel toe complies with ASTM F2413-11 and CSA Z195
- CSA Green Patch (sole protection and Grade 1 protective toe)



SAJ689



Model No.	Mfg. No.	Size	Model No.	Mfg. No.	Size	Price/Each
SAJ689	86622-6	6	SAJ693	86622-10	10	62.90
SAJ690	86622-7	7	SAJ694	86622-11	11	62.90
SAJ691	86622-8	8	SAJ695	86622-12	12	62.90
SAJ692	86622-9	9	SAJ696	86622-13	13	62.90

## BLACKHAWK RUBBER BOOTS

- Made with lightweight thermoplastic rubber for better water resistance
- Features removable comfort made insole and self-cleaning outsole
- Colour: Black
- Certifications: CSA/ASTM Approved
- Waterproof



SGG382

Model No.	Mfg. No.	Shoe Size	Model No.	Mfg. No.	Shoe Size	Price/Each
<b>STEEL TOE</b>						
SGG411	LICO-MT01-BR1-7	7	SGG388	LICO-MP01-BR1-7	7	80.10
SGG413	LICO-MT01-BR1-8	8	SGG390	LICO-MP01-BR1-8	8	80.10
SGG415	LICO-MT01-BR1-9	9	SGG392	LICO-MP01-BR1-9	9	80.10
SGG417	LICO-MT01-BR1-10	10	SGG394	LICO-MP01-BR1-10	10	80.10
SGG419	LICO-MT01-BR1-11	11	SGG396	LICO-MP01-BR1-11	11	80.10
SGG421	LICO-MT01-BR1-12	12	SGG398	LICO-MP01-BR1-12	12	80.10
SGG423	LICO-MT01-BR1-13	13	SGG400	LICO-MP01-BR1-13	13	80.10
<b>STEEL TOE/STEEL PLATE</b>						

## SERVUS® PRM™ II PVC BOOTS

- Seamless, injection molded footwear is 100% waterproof
- Flexible steel midsoles provides outstanding under-foot puncture protection
- Steel toe protection
- Open pattern outsole design self-cleans liquid and debris with every step, helping to prevent slip and trip hazards
- Height: 15"
- Colour: Black



SGC051

## SERVUS®

Model No.	Mfg. No.	Size	Model No.	Mfg. No.	Size	Price/Each
SGC051	75125C-7	7	SGC055	75125C-11	11	66.20
SGC052	75125C-8	8	SGC056	75125C-12	12	66.20
SGC053	75125C-9	9	SGC057	75125C-13	13	66.20
SGC054	75125C-10	10	SGC058	75125C-14	14	66.20

## BULLY BOOTS

- Acid and oil-resistant Ultraflex™ compound
- Generous wider fit
- Self-cleaning outsole
- GelFlex fatigue resistant mid sole
- Slip resistant first impact heel strike design
- Also available in white
- Certified to CSA standard Z195



SAL023

### RECOMMENDED APPLICATIONS:



Model No.	Mfg. No.	Shoe Size	Model No.	Mfg. No.	Shoe Size	Price/Each
<b>STEEL TOE</b>						
SAL013	9677-587-7	7	SAL020	9679-587-7	7	89.50
SAL014	9677-587-8	8	SAL021	9679-587-8	8	89.50
SAL015	9677-587-9	9	SAL022	9679-587-9	9	89.50
SAL016	9677-587-10	10	SAL023	9679-587-10	10	89.50
SAL017	9677-587-11	11	SAL024	9679-587-11	11	89.50
SAL018	9677-587-12	12	SAL025	9679-587-12	12	89.50
SAL019	9677-587-13	13	SAL026	9679-587-13	13	89.50
<b>STEEL TOE/STEEL PLATE</b>						

Other sizes available

## HAZMAX® 16" KNEE BOOTS

- Steel toe complies with ASTM F2413-11 and CSA Z195
- CSA Green Patch (sole protection and Grade 1 protective toe)
- Steel toe, steel shank and steel mid-sole for complete protection
- One-piece injection molded construction, eliminates seams
- Boots are constructed of high viscosity and flexible PVC alloy
- Non-absorbent polyester lining for easy cleaning and quick drying
- Replaceable cushioned insoles
- Cut off bands
- Kick off lug
- For use in situations involving dangerous chemicals, gasses or biological hazards and waste
- Exceeds CSA standards for dielectric footwear
- Certified by SEI to meet the requirements of NFPA 1991, 2005 edition



Model No.	Mfg. No.	Size	Price/Each
SC620	87012-6	6	219.00
SC621	87012-7	7	219.00
SC622	87012-8	8	219.00
SC623	87012-9	9	219.00
SC624	87012-10	10	219.00
SC625	87012-11	11	219.00
SC626	87012-12	12	219.00
SC627	87012-13	13	219.00
SAP837	87012-14	14	219.00
SAP838	87012-15	15	219.00

## BOOT COVERS

### 12" LATEX HAZMAT

Made of 0.60 mm, high visibility yellow latex rubber, the Hazmat boot cover offers protection from a broad range of materials. Seamless covers provide a snug fit over existing footwear for an added layer of protection. The ribbed and textured sole provides traction on a variety of slippery surfaces. Strong enough to be worn many times, yet economical enough to be disposed of after a single use. 100% waterproof.



SD638

### 15" PVC BOOT/SHOE COVER

Made of a strong 0.20 mm PVC upper, heat-welded to a hard, embossed 0.50 mm PVC sole for superior slip resistance. Completely waterproof, equipped with an elastic top for easy pullover comfort and a secure snug fit. 100% waterproof.

Model No.	Mfg. No.	Size	Fits Size	Price /Each
<b>12" LATEX HAZMAT</b>				
SD588	97591-L	Large	7 - 9	16.80
SD589	97591-XL	X-Large	10 - 12	16.80
SAP794	97591-2X	2X-Large	13 - 16	16.80

### 15" PVC BOOT/SHOE COVER

SD636	97590-M	Medium	6 - 8	11.80
SD637	97590-L	Large	9 - 11	11.80
SD638	97590-XL	X-Large	12 - 14	11.80

## MINER 49ER PROFESSIONAL MINING BOOTS

- Handcrafted 100% waterproof ozone-resistant natural rubber
- Heavy-duty cotton canvas lining
- Air-cushioned sole pockets
- Achilles tendon and ankle protection
- Oil and chemical-resistant nitrile lug sole
- Removable comfort felt insole
- ANSI MT/75 metatarsal protection
- CSA class #1 steel toe and plate
- CSA Omega – electric shock resistant



Model No.	Mfg. No.	Size	Model No.	Mfg. No.	Size	Price/Each
<b>REGULAR 14"</b>						
SAN663	VW 49-7	7	SAN684	VW49T-7	7	194.00
SAN664	VW 49-8	8	SAN685	VW49T-8	8	194.00
SAN665	VW 49-9	9	SAN686	VW49T-9	9	194.00
SAN666	VW 49-10	10	SAN687	VW49T-10	10	194.00
SAN667	VW 49-11	11	SAN688	VW49T-11	11	194.00
SAN668	VW 49-12	12	SAN689	VW49T-12	12	194.00
SAN669	VW 49-13	13	SAN690	VW49T-13	13	194.00

Other sizes available

## WHITE PVC STEEL TOE BOOTS

- Designed for use where mild chemical resistance is required
- Designed to help processing plants comply with HACCP guidelines
- Injected molded seamless construction
- Steel toe style complies with ASTM F2413-11
- Safety-Lok outsole
- Reinforced steel shank for added safety and comfort
- Replaceable cushion insoles
- Cut-off bands for height adjustment
- Pull-up and kick-off lugs for easy on and off
- Plain toe also available



SC573



Model No.	Mfg. No.	Size	Model No.	Mfg. No.	Size	Price/Each
SC573	81012-6	6	SC577	81012-10	10	65.10
SC574	81012-7	7	SC578	81012-11	11	65.10
SC575	81012-8	8	SC579	81012-12	12	65.10
SC576	81012-9	9	SC580	81012-13	13	65.10

## STEPLITEX SAFETY BOOTS

- Long-lasting, tough-wearing PU remains flexible at -30°C / -22°F
- Anti-clogging sole for added slip resistance
- Anti-bacterial and abrasion-resistant lining
- Kick-off spur for quick removal
- Shock-absorbent heel
- Cut-off line to make shorter boot from 15" to 11.5"
- Lightweight, comfortable and flexible
- Ergonomic, shock-absorbing, washable footbeds
- Resistant to mineral, manure, vegetable and animal oil or fats, blood and various chemical cleaning products
- Boot Type: Dielectric
- Toe Type: Non-metallic
- Material: Polyurethane
- Waterproof: Impermeable
- CSA Omega - Electric Short Resistant 18kV
- Certification(s): CSA Green Triangle/CSA Omega



SGF016



Model No.	Mfg. No.	Size	Model No.	Mfg. No.	Size	Price/Each
<b>GREEN/BLACK BOOTS</b>			<b>WHITE/BLUE BOOTS</b>			
SGF016	X290GB-5	5	SGP516	X290WB-5	5	152.00
SGF017	X290GB-6	6	SGP517	X290WB-6	6	152.00
SGF018	X290GB-7	7	SGP518	X290WB-7	7	152.00
SGF019	X290GB-8	8	SGP519	X290WB-8	8	152.00
SGF020	X290GB-9	9	SGP520	X290WB-9	9	152.00
SGF021	X290GB-10	10	SGP521	X290WB-10	10	152.00
SGF022	X290GB-11	11	SGP522	X290WB-11	11	152.00
SGF023	X290GB-12	12	SGP523	X290WB-12	12	152.00
SGF024	X290GB-13	13	SGP524	X290WB-13	13	152.00
SGF025	X290GB-14	14	SGP525	X290WB-14	14	152.00

# FOOT PROTECTION

## HIP WADERS

- Superior, waterproof protection to the hips
- Steel toe and steel mid sole hip wader with Ultragrip® sipe outsole
- Injected molded seamless boot construction
- CSA Green Patch (sole protection and Grade 1 protective toe)
- Excellent cold weather flexibility
- Lightweight/durable PVC upper with polyester backing
- Adjustable polyester nylon strap
- Can be folded or rolled without cracking
- Resist oil, grease, gasoline, saltwater and ozone
- Non-absorbent lining
- Replaceable cushion insoles
- Measurement from heel to top of wader: Inseam 32", outseam 35"
- Excellent for use in utilities, municipalities, aquaculture and commercial fishing
- Steel toe complies with ASTM F2413-11 and CSA Z195



## CHEST WADERS

- Superior, waterproof protection
- Injected molded seamless boot construction
- Steel toe complies with ASTM F2413-11 and CSA Z195
- CSA Green Patch (sole protection and Grade 1 protective toe)
- Steel midsole
- Ultragrip® sipe outsole
- Excellent cold weather flexibility
- Durable, heavy-duty PVC upper with polyester backing
- Adjustable polyester nylon strap
- Can be folded or rolled without cracking
- Resists oil, grease, gasoline, salt water and ozone
- Top drawstring closure for snug fit
- Non-corrosive, reinforced suspender buttons
- Built-in belt loops with adjustable belt
- Non-absorbent lining
- Replaceable cushion insoles
- For use in utilities, municipalities, aquaculture and commercial fishing



Model No.	Mfg. No.	Size	Model No.	Mfg. No.	Size	Price/Each
SAP602	86856-6	6	SAP606	86856-10	10	274.00
SAP603	86856-7	7	SAP607	86856-11	11	274.00
SAP604	86856-8	8	SAP608	86856-12	12	274.00
SAP605	86856-9	9	SAP609	86856-13	13	274.00



Model No.	Mfg. No.	Size	Model No.	Mfg. No.	Size	Price/Each
SA0732	86867-6	6	SA0736	86867-10	10	332.00
SA0733	86867-7	7	SA0737	86867-11	11	332.00
SA0734	86867-8	8	SA0738	86867-12	12	332.00
SA0735	86867-9	9	SA0739	86867-13	13	332.00

## BUSHWHACKER CHAINSAW BOOTS

- Snug fit design and ergonomic insole
- SBR blended NR upper with cotton canvas lining
- Highly chemical resistant rubber upper
- Nylon cuff to seal out debris and dust
- Abrasion-, chemical-, and oil-resistant NBR lug sole
- Air-cushioned heel with Achilles tendon, ankle and metatarsal protection
- Steel plate
- Compatible with ice studs
- Exceeds 305 000 Flex Rating
- CSA Z195-14 "Green Fir Tree" Chainsaw Protection (Highest Class - Class 3: 28 m/sec chainsaw speed as per EN ISO 17249: 2013)
- Toe Type: Steel
- Certification(s): CSA Green Triangle, CSA Omega, ASTM F2413, CSA Chainsaw Protection
- Impermeable
- Electric Shock Resistance: 18 kV



Model No.	Mfg. No.	Size	Model No.	Mfg. No.	Size	Price/Each
NJE922	VW58-1-6	6	SAQ716	VW58-1-10	10	231.00
SAQ713	VW58-1-7	7	SAQ717	VW58-1-11	11	231.00
SAQ714	VW58-1-8	8	SAQ718	VW58-1-12	12	231.00
SAQ715	VW58-1-9	9	SAQ719	VW58-1-13	13	231.00

## PVC OVERBOOTS

- Four-way cleated outsole
- Heavy Flex-O-Thane PVC construction for added durability
- Premium protection
- Excellent cold weather flexibility
- Self-cleaning, slip resistance outsole
- Kick off lug for easy on and off
- Fits over most work shoes and boots

**Applications:** Construction, farming, utilities and food processing.



SAO188



Model No.	Mfg. No.	Size	Model No.	Mfg. No.	Size	Price/Each
10"			17"			
SED424	86020-XS	X-Small	SED422	86030-XS	X-Small	50.20
SAS322	86020-S	Small	SAO188	86030-S	Small	50.20
SAS323	86020-M	Medium	SAO189	86030-M	Medium	50.20
SAS324	86020-L	Large	SAO190	86030-L	Large	50.20
SAS325	86020-XL	X-Large	SAO191	86030-XL	X-Large	50.20
SED425	86020-2XL	2X-Large	SED423	86030-2XL	2X-Large	50.20

## REFINERY BOOTS

- Acid and oil-resistant oarprene compound
- -40 °C/-40 °F felt inner boot system
- 1" snow cuff
- Long wear self-cleaning outsole
- Steel toe and plate
- Certified to CSA standard Z195
- ESR/EH rated

### RECOMMENDED APPLICATIONS:

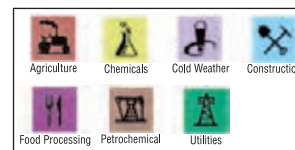

SAP945



## TITAN SAFETY BOOTS

- Fully moulded waterproof boot
- 1" snow cuff
- -100 °C/-148 °F comfort rated inner boot system
- Aggressive, long wearing, self-cleaning outsole design
- Micro cellular waffle foot-bed traps air and moisture
- Protective safety toe and plate
- CSA / ASTM approved
- ESR / EH rated
- Material: Rubber
- Toe Type: Steel
- Plate Type: Steel
- Standard: CSA Standard Z195/ESR/EH Rated
- Waterproof/Not Waterproof: Waterproof
- Temperature Rating: Up to -148 °F (-100 °C)



Model No.	Mfg. No.	Size	Model No.	Mfg. No.	Size	Price/Each
SDP294	2359-0000-7	7	SDP298	2359-0000-11	11	226.00
SDP295	2359-0000-8	8	SDP299	2359-0000-12	12	226.00
SDP296	2359-0000-9	9	SDP300	2359-0000-13	13	226.00
SDP297	2359-0000-10	10	SDP301	2359-0000-14	14	226.00

Model No.	Mfg. No.	Size	Model No.	Mfg. No.	Size	Price/Each
SAP945	8574-001-6	6	SAP950	8574-001-11	11	118.00
SAP946	8574-001-7	7	SAP951	8574-001-12	12	118.00
SAP947	8574-001-8	8	SAP952	8574-001-13	13	118.00
SAP948	8574-001-9	9	SAP953	8574-001-14	14	118.00
SAP949	8574-001-10	10	-	-	-	118.00



## EXPLORER™ GLACIER TREK CLEATS INSULATED OVERSHOES



- Features Glacier Trek™ SPK outsoles with 16 replaceable cleats embedded in the sole to help maintain traction in the harshest winter conditions
- The rugged but lightweight outsoles provide excellent slip resistance on ice and snow while the insulation and internal bootie keep your feet warm
- Specially formulated rubber remains flexible, even at sub-zero temperatures
- Equipped with an adjustable instep strap for a secure, quick fit
- 500 denier nylon upper fabric with waterproof membrane
- 4mm polyurethane foam insulation for additional warmth
- 2.5 mm polyurethane internal bootie
- 100% waterproof
- Tighten cleats with included cleat wrench before wearing outdoors
- If wearing over a work or combat boot, select one size up
- Material: Nylon, Rubber, Polyurethane
- Closure Type: Hook and Loop
- Insole Dimensions: 11"x4.3" • Height: 11"
- Comfort Rating: -29°C • Colour: Black



SHE845

Model No.	Mfg. No.	Size	Fits Size	Price /Each
SHE845	EXGG-S	Small	Men's 5 - 6.5, Women's 6 - 8	201.00
SHE846	EXGG-M	Medium	Men's 7 - 8.5, Women's 8.5 - 10	201.00
SHE847	EXGG-L	Large	Men's 9 - 10.5, Women's 10.5 - 12	201.00
SHE848	EXGG-XL	X-Large	Men's 11 - 12.5	201.00
SHE849	EXGG-2XL	2X-Large	Men's 13 - 14.5	201.00
SHE850	EXGG-3XL	3X-Large	Men's 15 - 16.5	201.00
SHE851	EXGG-4XL	4X-Large	Men's 17	201.00

## VOYAGER™ OVERSHOES



- Glacier Trek™ SPK outsole with 32 replaceable cleats per pair, provide excellent traction on ice and snow (NOT to be used on hard surfaces)
- Durable uppers are waterproof and windproof
- Cleat wrench included with convenient internal pocket to keep wrench handy and available to change cleats on the job
- Adjustable hook-and-loop strap system for a secure and comfortable fit
- Lightweight design to help prevent foot and leg fatigue
- Extra large gusset provides easy on/off
- Compact for convenient storage
- Material: Nylon • Closure Type: Hook and Loop
- Colour: Black • Height: 11"



SGW036

Model No.	Mfg. No.	Size	Fits Size	Price /Each
SGW042	VNG1BLKXSM	X-Small	3.5-5	171.00
SGW041	VNG1BLKSML	Small	5.5-7	171.00
SGW040	VNG1BLKMED	Medium	7.5-9	171.00
SGW039	VNG1BLKLRG	Large	9.5-11	171.00
SGW036	VNG1BLK1XL	X-Large	11.5-13	171.00
SGW037	VNG1BLK2XL	2X-Large	13.5-15	171.00
SGW038	VNG1BLK3XL	3X-Large	15.5-17	171.00

## ADVENTURER ALL SEASON OVERSHOES



- Nylon upper with Perma outsole offers good traction in tough weather conditions
- Calf-high coverage protects footwear and pant legs in snow or mud
- 100% waterproof
- Material: Nylon
- Height: 15"
- Closure Type: Hook and Loop



SEE832

Model No.	Mfg. No.	Size	Fits Size	Price /Each
SDP289	ANN1BLKXSM	X-Small	3.5-5	161.00
SEE832	ANN1BLKSML	Small	5.5-7	161.00
SEE833	ANN1BLKMED	Medium	7.5-9	161.00
SEE834	ANN1BLKLRG	Large	9.5-11	161.00
SEE835	ANN1BLK1XL	X-Large	11.5-13	161.00
SEE887	ANN1BLKXXL	2X-Large	13.5-15	161.00

## NAVIGATOR 5™ GLACIER TREK CLEATS INSULATED OVERSHOES



- The outsoles, with 16 removable cleats per pair, provide excellent traction on ice and snow (not to be used on hard surfaces)
- Cleat wrench included with convenient internal pocket to keep wrench handy and available to change cleats on the job
- Expandable gaiter top can roll-out to increase boot height to 20 inches
- 840 denier polyester polyester upper fabric with waterproof membrane
- 4mm polyurethane foam insulation for additional warmth
- 2.5 mm polyurethane internal bootie
- Duraflex® quick-release closure with adjustable hook-and-loop strap system
- 100% waterproof • Fits orthopedic footwear
- If wearing over a work or combat boot, select one size up
- Material: Polyurethane, Polyester
- Closure Type: Hook and Loop
- Height: 15" (20" with Gaiter)
- Comfort Rating: -29°C
- Colour: Green



SHE854

Model No.	Mfg. No.	Size	Fits Size	Price /Each
SHE854	N5P3G-XS	X-Small	Men's 3 - 4.5/Women's 4.5 - 6	251.00
SHE855	N5P3G-S	Small	Men's 5 - 6.5/Women's 6 - 8	251.00
SHE856	N5P3G-M	Medium	Men's 7 - 8.5/Women's 8.5 - 10	251.00
SHE857	N5P3G-L	Large	Men's 9 - 10.5/Women's 10.5 - 12	251.00
SHE858	N5P3G-XL	X-Large	Men's 11 - 12.5	251.00
SHE859	N5P3G-2XL	2X-Large	Men's 13 - 14.5	251.00
SHE860	N5P3G-3XL	3X-Large	Men's 15 - 16.5	251.00
SHE861	N5P3G-4XL	4X-Large	Men's 17	251.00

## EXPLORER OVERSHOES



- Extremely lightweight and offer durable long lasting overshoes
- Provide warmth to feet, are 100% waterproof and windproof
- Very quick and snug fit adjustment
- Nylon upper fabric, Superlite outsole



SED280

Model No.	Mfg. No.	Size	Fits Size	Price /Each
SED280	EXPGBLKXSM	X-Small	3.5-5	181.00
SED281	EXPGBLKSML	Small	5.5-7	181.00
SED282	EXPGBLKMED	Medium	7.5-9	181.00
SED283	EXPGBLKLRG	Large	9.5-11	181.00
SED284	EXPGBLK1XL	X-Large	11.5-13	181.00
SED285	EXPGBLK2XL	2X-Large	13.5-15	181.00
SED286	EXPGBLK3XL	3X-Large	15.5-17	181.00

## NAVIGATOR 5™ EXPANDABLE OVERSHOES



- Durable polyester upper with waterproof membrane
- Aggressive Vibram® Ninja™ outsole offers superior traction on ice, snow and slush
- Overshoes are lightweight to prevent foot and leg fatigue
- Wide, easily opened gusset provide ease in putting on or taking off overshoes



SED287

Model No.	Mfg. No.	Size	Fits Size	Price /Each
SED287	N5P3GRYXSM	X-Small	3.5-5	226.00
SED288	N5P3GRYSML	Small	5.5-7	226.00
SED289	N5P3GRYMED	Medium	7.5-9	226.00
SED290	N5P3GRYLRG	Large	9.5-11	226.00
SED291	N5P3GRY1XL	X-Large	11.5-13	226.00
SED292	N5P3GRY2XL	2X-Large	13.5-15	226.00
SDP293	N5P3GRY3XL	3X-Large	15.5-17	226.00

# FOOT PROTECTION

## ICE BEAR WINTER SAFETY BOOTS

- Light weight abrasion resistant polyurethane molded boot
- Acid and oil resistant rubber outsole provides superior traction at extreme cold temperatures
- New lug outsole design provides added traction on packed snow and icy conditions
- Temperature comfort rating: -50 °C/-58 °F
- Certified to CSA standard
- ESR/EH rated



**BAFFIN**  
INDUSTRIAL

Model No.	Mfg. No.	Size	Price /Each
SEI704	5157-0000-672-07	7	283.00
SEI705	5157-0000-672-08	8	283.00
SEI706	5157-0000-672-09	9	283.00
SEI707	5157-0000-672-10	10	283.00
SEI708	5157-0000-672-11	11	283.00
SEI709	5157-0000-672-12	12	283.00
SEI710	5157-0000-672-13	13	283.00
SEI711	5157-0000-672-14	14	283.00

Other sizes available

## HEAVY-DUTY ANTI-SLIP ICE CLEATS

- Hexagonal, non-slip studs offer excellent traction on ice and snow
- Non-slip heavy duty flexible rubber boot
- Includes 12 durable spikes
- Made from thermoplastic elastomer
- Flexible up to -40°C



**ZENITH**<sup>®</sup>  
Safety Products

Model No.	Fits Shoe Size	Price /Each
SDN085	5-8	24.95
SDN086	8-11	24.95
SDN087	11-13	24.95

## ANTI-SLIP ICE CLEATS

- Special non-slip studs offer excellent traction on ice and snow
- Non-slip flexible ice cleats
- Includes 10 durable spikes
- Made from thermoplastic elastomer
- Flexible up to -40°C



Boot not included

**ZENITH**<sup>®</sup>  
Safety Products

Model No.	Fits Shoe Size	Price /Each
SEA004	5-8	19.95
SEA005	8-11	19.95
SEA006	11-13	19.95

## ANTI-SLIP SPARK-PROOF ICE CLEATS

- Non-slip studs offer excellent traction on ice and snow
- Includes 10 durable brass spikes
- Made from thermoplastic elastomer
- Flexible up to -40°C
- Non-slip, heavy-duty, flexible rubber boot



**ZENITH**<sup>®</sup>  
Safety Products

Model No.	Fits Shoe Size	Price /Each
SG0246	5-8	28.25
SG0247	8-11	28.25
SG0248	11-13	28.25

## GRIPPRO™ SPIKELESS TRACTION AIDS

- 11 (22/pair) patented hi-viz chevrons are strategically placed to increase grip and reduce the risk of slips and falls
- Specially designed treads channel water away to deliver enhanced traction
- Natural rubber material with proprietary polymer blend maintains flexibility even in sub-zero temperatures
- Slip-on design fits snugly over boots and shoes
- Easy on-off pull tab provides quick adjustment
- Can be worn while driving, climbing ladders, and walking on grates
- Ideal for warehousing, delivery, construction, first responders, and much more
- Traction Type: Grooved
- Traction Material: Rubber



Boot not included

**dn**  
duenorth

Model No.	Mfg. No.	Size	Price /Each
SHA880	V3553570-S/M	Small, Medium	60.90
SHA881	V3553570-L/XL	Large, X-Large	60.90

## HEEL TRACTION AID

- Convenient hook and strap with adjustment system provides a quick, easy, comfortable, and secure fit on a wide variety of footwear
- The Ice Diamond™ spikes and bi-directional tread provide powerful traction with maximum grip
- Ideal for drivers, delivery personnel, or anyone operating machinery where use of conventional, full coverage traction aids may interfere with driving capabilities
- Traction pad can be flipped or slid from underneath the heel to avoid damage to walking surfaces
- Size: One Size
- Traction Type: Stud
- Traction Material: Tungsten Carbide

Model No. SGQ698  
Mfg. No. V3550470-O/S  
Price/Each \$43.90



Boot not included

**dn**  
duenorth

## K1 SERIES MID-SOLE ICE CLEATS

- The ice-penetrating tungsten carbide spikes maximize grip while the rotatable design provides seamless transition when traction is not required (driving, climbing, and indoor use)
- Strategically placed ice-penetrating tungsten carbide spikes provide maximum traction on ice and snow
- Specially formulated rubber pad provides maximum comfort and durability even in extreme cold weather conditions



Boot not included

NJM116

**K1**  
SERIES

Model No.	Mfg. No.	Description	Colour	Price /Each
NJM116	K1MID	Original Profile	Orange/Black	42.80
SGP207	K1MID-BLK	Mid-Sole	Black	42.80
SGP205	K1MID-LP	Low Profile	Orange	42.80
SGP208	K1MID-LP-BLK	Low Profile	Black	42.80
SGP206	K1MID-HP	High Profile	Orange	42.80
SGU817	K1MID-HP-BLK	High Profile	Black	42.80

## TOE GUARDS

- Resistant 15-gauge carbon steel construction for maximum toe protection
- 75-lb. impact rating
- Adjustable straps permit adjustability and optimal fit
- Weight: 21 oz. per pair
- 4.5" W
- One size fits all
- Sold per pair

Model No. SEE903  
Price/Each \$24.95



Shoe not included



## FOOT GUARDS

- Lightweight and resistant plastic construction
- 30-lb. impact rating
- Rubber straps on heel and sole permit adjustability and optimal fit
- Weight: 14 oz. per pair
- Colour: Green
- 4.5" W
- One size fits all
- Sold per pair

Model No. SEE902  
Price/Each \$19.75



Shoe not included



## METATARSAL GUARDS

- Lightweight and resistant aluminum construction
- Designed to fit on work boot laces
- Spring fasteners permit adjustability and optimal fit
- Contains a foam pad to hold in place while protecting against impact
- Impact Rating: 33-lb.
- Weight: 7 oz. per pair
- One size fits all
- Sold per pair

Model No. SEE904  
Price/Each \$25.50



Boot not included



## TOE WARMERS

- Fits easily inside your boots or shoes
- Long lasting heat
- Do not use directly on skin
- Hours of Effective Warmth: 6 hrs.
- Qty/Pkg.: 2
- Type: Single Use

Model No. SGU490  
Price/Each \$1.65



## TURBOTOE SAFETY TOE CAPS

- 100% waterproof, will not harden, stiff or crack
- Perfect for visitors, casual or temporary workers, management, clerical staff and sales people
- Can be comfortably worn over low-heel, dress and running shoes, and most boots
- Ideal for many working environment that carry a risk of toe damage, or has a steel toe cap requirement
- Certified to CSA standard Z334-14 Protective Footwear Grade 1 protection



IMPACTO  
PROTECTIVE PRODUCTS



Sold per Pair



Model No.	Mfg. No.	Size	Fits Size	Colour	Price /Each
SED175	TTCASXS	X-Small	4-5	Grey	47.30
SED176	TTCASAS	Small	6-7	White	47.30
SED177	TTCASAM	Medium	8-9	Yellow	47.30
SED178	TTCASAL	Large	10-11	Red	47.30
SED179	TTCASAXL	X-Large	12-13	Blue	47.30
SED180	TTCASAXXL	2X-Large	13-14	Green	47.30
SDS772	TTCASXXXL	3X-Large	15-16	Black	47.30

## TOES2GO® STEEL TOE CAP

- Made of flexible and stretchy, pliable PVC
- Threads under sole to prevent slipping and help liquid flow away from the foot
- Fully-adjustable rear 18" X 1" strap and hoop & loop closure allow for versatility of use
- 100% waterproof
- Will not harden, stiffen or crack
- Can be comfortably worn over dress shoes, running shoes, most boots and even shoes with low heels
- Certification(s): CSA Z334-14
- Sold per pair



IMPACTO  
PROTECTIVE PRODUCTS



Model No.	Mfg. No.	Size	Fits Shoe Size	Colour	Price /Each
SGS894	T2GCSAS	Small	2-7	White	61.80
SGS895	T2GCSAM	Medium	8-13	Red	61.80
SGS896	T2GCSAL	Large	13-16	Green	61.80

## NON-CONDUCTIVE METATARSAL GUARDS

- Unlike traditional metatarsal guards, the Metguard is non-conductive for heat and electricity
- Fits all safety shoes and boots with optional attachment straps sold separately
- Used with existing footwear and transferable between users and footwear
- Practical, comfortable, easy to fit and simple to use
- Suitable for use in all workplaces and industries including mining, construction, manufacturing, transport, storage, forestry, retail trade, warehousing, storage, forestry, retail trade
- Tested to conform with stringent Worldwide Safety Footwear Standards
- Sold per pair

Model No. SED173  
Mfg. No. METGUARD  
Price/Each \$62.20

### OPTIONAL METSTRAP

Model No. SED174  
Mfg. No. METSTRAP  
Price/Each \$11.90



IMPACTO  
PROTECTIVE PRODUCTS



# KNEE & KNEELING PADS

## GEL KNEE PADS

### LIGHTWEIGHT GEL

- Non-slip rubber cap grips kneeling surface
- Lightweight gel and EVA foam for mobile comfort
- Plastic clips cinch tight and keep straps secure



### Short Cap

- Short cap design for mobility when kneeling
- Bottom webbing and top elastic straps

### Long Cap

- Long cap design provides protection and stability
- Bottom webbing and top elastic straps

### Round Cap

- Round cap for highest degree of kneeling mobility
- Breathable perforated neoprene bottom strap

### INJECTED GEL

- Non-slip rubber cap grips kneeling surface
- injected gel and PU foam for all-day comfort
- Plastic clips cinch tight and keep straps secure

### Short Cap

- Short cap for mobility when kneeling
- **SFU727:** Padded straps on thigh and calf will not bind up

### Long Cap

- Long cap design provides protection and stability
- Bottom webbing and top elastic straps

### Extra Long Cap

- Extra long cap for maximum coverage and stability
- Breathable perforated neoprene top strap
- Bottom elastic strap secures knee pad around calf
- Extended shin protection optimizes stability

SFU731



SFV095



SFV096



SFU726



SFU730



SFU727



SFU733



Priced per Pair

Model No.	Mfg. No.	Description	Price /Each
SFV095	18457	Short Cap	51.30
SFU731	18447	Long Cap	80.40
SFV096	18467	Round Cap	61.30

Priced per Pair

Model No.	Mfg. No.	Description	Price /Each
SFU733	18455	Short Cap	71.10
SFU727	18444	Short Cap, Padded Straps	112.00
SFU730	18445	Long Cap	99.50
SFU726	18442	Extra Long Cap	142.00

## KNEELING MAT

- Provides comfort during long kneeling situations
- Built-in carrying handle makes transport easy and convenient
- Length: 14"
- Width: 21"
- Thickness: 1"

Model No. SHF157  
Price/Each \$26.95



## KNEE PADS

- Hook and loop strap for easy donning and removal
- Durable, lightweight construction
- Comfortable, thick-molded foam
- Pad Type: Foam
- Cap Material: Foam

Model No. SHF156  
Price/Each \$10.95



## KNEELING PADS

- Comfort for static kneeling situations
- Closed cell foam is non-conductive, resistant to petroleum and silicon-free
- Convenient handle included

SEB125



Model No.	Mfg. No.	Dimensions"	Price /Each
SEB125	18380	14 x 21 x 1	59.10
SEB479	18385	16 x 28 x 1	94.60
SEB480	18390	18 x 36 x 1	119.00



## PROFLEX® 375 COMPACT KNEELING PAD

- Compact size for optimal portability
- Convenient handle also allows for hanging storage
- Fits in most standard toolboxes/toolbags



Model No.	Mfg. No.	Dimensions"	Price /Each
SEM546	18376	18 x 8 x 1	33.90



## PROFLEX® 260 SOFT SLIP-ON KNEE PADS

- Lightweight
- Soft outer cloth and foam padding
- Woven elastic sleeve for easy on and off
- Wear over or under clothing
- Machine washable



Sold per Pair

Model No.	Mfg. No.	Closure Type	Pad Material	Price /Each
SEL575	18260	Slip-on	Foam	24.70

## FOAM KNEE PADS

- Durable copolymer foam padding provides excellent protection and value
- Form fitted, lightweight molded pad with ribbed kneeling surface
- One hook and loop strap for easy donning
- One size fits all



Sold per Pair

Model No.	Mfg. No.	Description	Price /Each
SEB475	18200	Light-Duty Copolymer Single Strap	18.20

## PVC CAP KNEE PADS

- Polyester shell with a neoprene lining for superior abrasion resistance
- Embossed PVC cap provides optimal kneeling grip and stability
- EVA foam padding provides superior comfort while kneeling



Sold per Pair

Model No.	Closure Type	Pad Material	Price /Each
SGF756	Buckle/Hook & Loop	Foam	27.45



## PROFLEX® 350 GEL FOAM KNEE PAD

- 12 mm NBR Gel padding & 20 mm EVA padding
- 1680D ballistic nylon outer shell for puncture resistance
- 420D nylon & Hypalon rubber composite pad
- Slip-resistant durable nylon-rubber surface
- Adjustable, breathable neoprene stretch strap



Sold per Pair

Model No.	Mfg. No.	Closure Type	Pad Material	Price /Each
SEL563	18350	Hook & Loop	Gel	79.20

## PROFLEX® 335 SLIP RESISTANT RUBBER CAP KNEE PADS

- 12 mm NBR foam padding cut to hug the knee
- 840D nylon fabric cover
- Slip-resistant long rubber cap grips wet or dry work surfaces
- Anti-odour treatment
- Nickel-plated grommets
- Pad material: Foam



SEL570



Sold per Pair

Model No.	Mfg. No.	Closure Type	Price /Each
SEL570	18335	Buckle	47.50
SEL571	18336	Hook & Loop	45.80

## PROFLEX® 230 WIDE SOFT CAP KNEE PADS

- Durable 600D polyester fabric cover
- 15 mm closed cell foam padding
- Slightly wider and longer for wraparound comfort
- Anti-odour treatment
- One size adjusts for exact fit
- Thick padding and durable covers
- Pad Material: Foam
- Number of Straps: 2



SEL573

Sold per Pair

Model No.	Mfg. No.	Closure Type	Price /Each
SEL573	18230	Buckle	37.60
SEL574	18231	Hook & Loop	35.80

## TURBOKNEE KNEE PADS

- Durable yet lightweight 1" EVA molded foam padding provides superior comfort and knee support
- Hinged design protects from impact while keeping dirt and debris away from the knee
- Maximum protection from cumulative trauma when working on your knees for long periods
- Strapping system eliminates discomfort behind the knee
- Ideal for work in heavy duty environments such as roofing, construction, mining and shipbuilding
- Made with 100% PVC-Free materials
- Cap Material: Plastic



IMPACTO  
PROTECTIVE PRODUCTS



Sold per Pair

Model No.	Mfg. No.	Closure Type	Pad Material	Price /Each
SGJ668	895-00	Buckle	Foam	46.30

## KNEE PADS

- High density foam padding
- Nylon outer cover

### FLEXIBLE

- Rounded elastic cap with grommets
- Double elastic straps with adjustable hook and loop closure

### PLASTIC CAP

- Sewn-on ribbed plastic cover to protect from impact
- Double straps with adjustable plastic buckle closure



IMPACTO  
PROTECTIVE PRODUCTS



SEE110

SEE112

Sold per Pair

Model No.	Mfg. No.	Description	Price /Each
SEE110	827-00	Flexible Knee Pads	29.80
SEE112	826-00	Plastic Cap Knee Pads	33.40

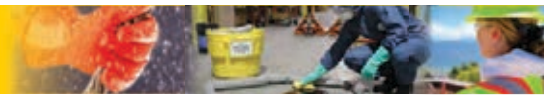

## THERMO WRAP WRIST SUPPORTS

- Non-porous rubberized material captures body heat
- Lining wicks away moisture which helps prevent skin irritation
- Increases circulation and provides compression and support
- Loops around thumb
- Hook and loop closure



Model No.	Mfg. No.	Measurement"	Price /Each
SEE128	TS226SS	4.5 to 6.25	31.90
SEE129	TS226M	6.5 to 7.5	31.90
SEE130	TS226LXL	7.75 to 10	31.90

## ELASTIC WRIST SUPPORTS

- Limits the wrist from over flexing and over extending to help prevent repetitive strain injuries
- Flexible spiral stays provide support
- Loops around thumb to keep in place
- Elastic strap with hook and loop closure
- Available with single or double strap closures
- Single strap has stays on palm side
- Double straps has stays on palm and dorsal side



Left Model No.	Mfg. No.	Right Model No.	Mfg. No.	Measurement"	Price /Each
<b>SINGLE STRAP</b>					
SEE131	EL40SL	SEE135	EL40SR	4.5 to 5.5	26.50
SEE132	EL40ML	SEE136	EL40MR	6.5 to 7.5	26.50
SEE133	EL40LL	SEE137	EL40LR	7.5 to 8.5	26.50
SEE134	EL40XLL	SEE138	EL40XLR	8.5 to 11	26.50
<b>DOUBLE STRAP</b>					
SEE139	EL41SL	SEE143	EL41SR	4.5 to 5.5	36.50
SEE140	EL41ML	SEE144	EL41MR	6.5 to 7.5	36.50
SEE141	EL41LL	SEE145	EL41LR	7.5 to 8.5	36.50
SEE142	EL41XLL	SEE146	EL41XLR	8.5 to 11	36.50

## GEL-PADDED WORK GLOVES

- General purpose half finger glove
- Abrasion and impact protection
- Padding in the palm and index finger
- Terry cloth and grey spandex back
- Terry cloth thumb, black leather palm
- Wrist tab with hook and loop closure
- Open back for cool comfort



SAR673



Priced per Pair

Model No.	Mfg. No.	Size	Price /Each
SAR673	400-00S	Small	29.40
SAR674	400-00M	Medium	29.40
SAR675	400-00L	Large	29.40
SAR676	400-00XL	X-Large	29.40
SDP613	400-00XXL	2X-Large	29.40

## PROFLEX® 400 UNIVERSAL WRIST WRAP

- Hook & loop closure
- Ambidextrous
- Size: One Size



Model No.	Mfg. No.	Colour	Price /Each
SEL632	72102	Black	4.73
SEL633	72103	Tan	4.73

## UNIVERSAL ELASTIC WRIST SUPPORTS

- Sorbothane® padding absorbs impact and vibration
- Universal 3" elastic wrist support with a poly/cotton covered Sorbothane® strip
- Adjustable hook and loop closure



Model No.	Mfg. No.	Price /Each
SEE126	ERWW	14.70

## THERMAL WRIST WRAPS

- Relieves stress, strains, swelling and tendinitis by providing a wrist joint compression support
- Allows for free hand movement
- Jersey-covered neoprene retains body heat
- Hook and loop closure



Model No.	Mfg. No.	Price /Each
SEE127	ERT01	21.60

## PROFLEX® 4010 DOUBLE STRAP WRIST SUPPORT

- Supplemental support to help relieve stress associated with repetitive strain and overuse injuries
- Limits downward and upward (flexion and extension) movements
- Patented Open-Center Stay™
- Three-stage hook & loop closure
- Anti-odour treatment



Model No.	Mfg. No.	Size	Price /Each
<b>LEFT</b>			
SEE764	70032	Small	32.10
SEE765	70034	Medium	32.10
SEA576	70036	Large	32.10
SEE766	70038	X-Large	32.10
<b>RIGHT</b>			
SEE767	70022	Small	32.10
SEA327	70024	Medium	32.10
SEA574	70026	Large	32.10
SEA575	70028	X-Large	32.10

## PROFLEX® 4000 SINGLE STRAP WRIST SUPPORT

- Limits downward (flexion) wrist movements
- Patented Open-Center Stay™
- Three-stage hook & loop closure
- Anti-odour treatment



Model No.	Mfg. No.	Size	Price /Each
<b>LEFT</b>			
SEE756	70112	Small	20.60
SEE757	70114	Medium	20.60
SEE758	70116	Large	20.60
SEE759	70118	X-Large	20.60
<b>RIGHT</b>			
SEE760	70102	Small	20.60
SEE761	70104	Medium	20.60
SEE762	70106	Large	20.60
SEE763	70108	X-Large	20.60

## PROFLEX® 420 WRIST WRAP WITH THUMB LOOP

- Hook & loop closure
- Ambidextrous



Model No.	Mfg. No.	Size	Price /Each
<b>BLACK</b>			
SEL634	72222	Small/Medium	5.46
SEL635	72224	Large/X-Large	5.46
<b>TAN</b>			
SEL636	72232	Small/Medium	5.46
SEL637	72234	Large/X-Large	5.46



## TENNIS ELBOW BRACES

- Supports the upper forearm during activities involving repeated hand motion
- Provides relief and prevention of pain related to muscle strain, tendinitis, repetitive motion, carpal tunnel syndrome, lateral epicondylitis
- Adjustable strap with hook and loop closure



Model No.	Mfg. No.	Measurement"	Price /Each
SEE114	EL5002S	9 to 10.5	32.30
SEE115	EL5002M	11 to 12	32.30
SEE116	EL5002L	12 to 14	32.30
SEE117	EL5002XL	14 to 16.5	32.30



## THERMO WRAP TENNIS ELBOW SUPPORTS

- Layered heat retaining materials
- Soft lining wicks away moisture and keeps skin warm
- Aids in the prevention and treatment of medical-lateral epicondylitis
- Prevents overloading where forearm strain is an occupational hazard
- Padding provides localized compression to the problem area
- Adjustable hook and loop closure



Model No.	Mfg. No.	Measurement"	Price /Each
SEE118	TS205S	9 to 10.5	38.90
SEE119	TS205M	11 to 12	38.90
SEE120	TS205L	12 to 14	47.30
SEE121	TS205XL	14 to 16.5	38.90



## FOREARM PROTECTORS

- Layered foam and viscoelastic pad
- Protects forearm from impact or pressure points
- Tubular poly/cotton lycra sleeve with leather cover



Model No.	Mfg. No.	Size	Price /Each
<b>SPLIT LEATHER</b>			
SR317	805-10S	Small	37.40
SR318	805-10M	Medium	37.40
SR319	805-10L	Large	37.40
SR320	805-10XL	X-Large	37.40
<b>GRAIN LEATHER</b>			
SR313	805-20S	Small	41.10
SR314	805-20M	Medium	41.10
SR315	805-20L	Large	41.10
SR316	805-20XL	X-Large	41.10

## ELBOW PROTECTORS

- Made from stretch fabric with leather cover for abrasion protection
- Pull-on style, viscoelastic elbow pad provides excellent protection from impacts and pressure points



Model No.	Mfg. No.	Size	Price /Each
<b>SPLIT LEATHER</b>			
SR325	806-10S	Small	25.20
SR326	806-10M	Medium	25.20
SR327	806-10L	Large	25.20
SR328	806-10XL	X-Large	25.20
<b>GRAIN LEATHER</b>			
SR321	806-20S	Small	29.00
SR322	806-20M	Medium	29.00
SR323	806-20L	Large	29.00
SR324	806-20XL	X-Large	29.00

## PROFLEX® 650 NEOPRENE ELBOW SLEEVE

- Spandex mesh in elbow crease
- Ambidextrous
- Binding and pre-curve design
- Perforated neoprene body for enhanced breathability



Model No.	Mfg. No.	Size	Price /Each
SEL650	16572	Small	18.30
SEL651	16573	Medium	18.30
SEL652	16574	Large	18.30
SEL653	16575	X-Large	18.30
SEL654	16576	2X-Large	18.30



## PROFLEX® 500 ELBOW SUPPORT

- Strap with hook & loop closure
- Ambidextrous
- Neoprene four-way stretch fabric provides uniform support and warmth



Model No.	Mfg. No.	Size	Price /Each
SEL638	16001	X-Small	20.80
SEA542	16002	Small	20.80
SEA318	16003	Medium	20.80
SEA317	16004	Large	20.80
SEL639	16005	X-Large	20.80



## PROFLEX® 670 AMBIDEXTROUS SINGLE STRAP WRIST SUPPORT

- Reversible hook & loop strap
- Ambidextrous
- Supplemental support to help relieve stress associated with repetitive strain and overuse discomfort



Model No.	Mfg. No.	Size	Price /Each
SEI541	16612	Small	15.90
SEI542	16613	Medium	15.90
SEI543	16614	Large	15.90
SEI544	16615	X-Large	15.90



## LEATHER WRIST SUPPORTS

- Provides repetitive strain protection
- Helps prevent over extension and over flexion of the wrist
- Fingerless nylon/lycra palm
- Grain leather wrist support with hook and loop closure



Left Model No.	Mfg. No.	Right Model No.	Mfg. No.	Size	Price /Each
SAS168	705-20S-L	SAR677	705-20S-R	Small	29.00
SAS169	705-20M-L	SAR678	705-20M-R	Medium	29.00
SAS170	705-20L-L	SAR679	705-20L-R	Large	29.00
SAS171	705-20XL-L	SAR680	705-20XL-R	X-Large	29.00

# BRACES & SUPPORTS

## BACK SUPPORTS

- Reduces risk of lower back injury and offers added support
- Encourages proper lifting posture
- Adjustable two-stage straps permit optimal level of tension
- Double closure on cinch strap permits more adjustment options
- Adjustable elastic suspenders for maximum comfort and fit
- 8" reinforced primary belt
- Machine washable



Model No.	Size	Fits Waist	Price /Each
SEE905	Small	25" to 30"	14.75
SEE906	Medium	30" to 34"	14.75
SEE907	Large	34" to 38"	14.75
SEE908	X-Large	38" to 42"	14.75
SEE909	2X-Large	42" to 46"	14.75

## PROFLEX® 1051 MESH W/LUMBAR PAD

- Breathable mesh outer shell provides a cool, comfortable wear
- Uniquely designed with ventilated lumbar pad to fill the gap in the back's natural curve for comfortable support
- Adjustable two-stage closure helps remind wearers to lift properly
- Power panel positioner keeps elastic bands close to sides for ease of use - will not fall out of reach when not in use
- Machine washable
- Colour : Black



Model No.	Mfg. No.	Size	Price /Each
SAI223	20183	Small	54.50
SAI224	20184	Medium	54.50
SAI225	20185	Large	54.50
SAI226	20186	X-Large	54.50
SAI227	20187	2X-Large	54.50

## PROFLEX® 1505 LOW-PROFILE WEIGHT LIFTERS BACK SUPPORTS

- Flexible soft foam core provides support when lifting
- Low-profile design allows for superior mobility
- 6.25" (16 cm) low-profile tapered design
- Nylon jersey body fabric
- Easy cam buckle closure system
- Rubber track webbing
- Colour : Black



**Applications:** Material handling, construction, warehousing/distribution, maintenance, freight/baggage, assembly/fabrication, landscaping/grounds

Model No.	Mfg. No.	Size	Price /Each
SEI856	11491	Small	48.10
SEI857	11492	Medium	48.10
SEI858	11493	Large	48.10
SEI859	11494	X-Large	48.10
SEI860	11495	2X-Large	48.10

## PROFLEX® 2000SF PERFORMANCE SPANDEX

- Patented Sticky Fingers® stays deliver firm, continuous lower back and abdominal support, and have greater durability and gripping properties than industry-standard, rubber-tracked tape
- Patented contoured design comfortably hugs the body and naturally positions support on wearer
- 1 1/4" premium woven elastic suspenders are adjustable and detachable to improve comfort and fit
- Power panel positioner keeps elastic bands close to sides for ease of use and will not fall out of reach when not in use
- Woven cinch tabs are reinforced to stand up to daily wear
- Durable Spandex body cloth provides an ideal combination of breathability and consistent stretch
- Adjustable two-stage closure helps remind wearers to lift properly
- Machine washable
- Colour: Black



Model No.	Mfg. No.	Size	Price /Each
SAI207	11281	X-Small	79.60
SAI208	11282	Small	79.60
SAI209	11283	Medium	79.60
SAI210	11284	Large	79.60
SAI211	11285	X-Large	79.60
SAI212	11286	2X-Large	79.60
SAI213	11287	3X-Large	79.60
SAI214	11288	4X-Large	79.60

## PROFLEX® 1600 STANDARD ELASTIC

- 9" (22.8 cm) premium all-elastic body for extra firm support
- Contoured high-cut front panel
- Rubber track webbing
- Adjustable and detachable suspenders
- Non-conductive polypropylene stays
- Stretchable bias binding with zig-zag stitching



Model No.	Mfg. No.	Size	Price /Each
SEL586	11101	X-Small	43.60
SEE282	11102	Small	43.60
SEE283	11103	Medium	43.60
SEE284	11104	Large	43.60
SEE285	11105	X-Large	43.60
SEL587	11106	2X-Large	43.60
SEL588	11107	3X-Large	43.60
SEL589	11108	4X-Large	43.60

## PROFLEX® 1650 ECONOMY ELASTIC BACK SUPPORTS

- All-elastic 7.5-inch body for extra firm support
- 5-inch single strap closure
- Adjustable, detachable suspenders
- Stretchable bias binding with zig-zag stitching
- Rubber track webbing
- Material: Elastic



Model No.	Mfg. No.	Size	Price /Each
SAI215	11091	X-Small	28.60
SAI216	11092	Small	28.60
SAI217	11093	Medium	28.60
SAI218	11094	Large	28.60
SAI219	11095	X-Large	28.60
SAI220	11096	2X-Large	28.60
SAI221	11097	3X-Large	28.60
SAI222	11098	4X-Large	28.60

## WET-BULB GLOBE TEMPERATURE (WBGT) HEAT STRESS METERS

- Measures ambient temperature, humidity, wet bulb temperature, black globe temperature, WBGT (wet bulb global temperature), heat stress index, dew point and pressure
- Multi-line backlit LCD display simultaneously displays 4 measurements—maximum, minimum, average and data hold functions
- Internal memory stores up to 99 measurements
- User-adjustable WBGT threshold alarm (audible)
- Tripod mountable for long-term monitoring
- Low battery indicator and auto shut-off after 15 minutes
- Power Supply: 4 x AAA Batteries (included), Optional AC Adapter



### SPECIFICATIONS:

**Air Temp. Range:** 0 to 50°C (32 to 122°F)

**WBGT Temp. Range:** 15° - 59°C (59° - 138.2°F)

**Humidity Range:** 0 to 99.9% RH

**REED**

Model No.	Mfg. No.	Description	Price/Each
IB908	R6200	WBGT Heat Stress Meter	219.00
IB909	R6200-NIST	WBGT Heat Stress Meter with ISO Certificate	524.00
IB820	R1500	Tripod with Instrument Adapter	109.00
HN416	CA-05A	Carrying Case	32.00
IB914	R9933	Humidity Calibration Standard, 33 %	99.00
IB915	R9975	Humidity Calibration Standard, 75 %	99.00
IB916	R9980	Humidity Calibration Kit, 33 % and 75 %	189.00

## HEAT STRESS METER/DATA LOGGER

- Measures indoor and outdoor WBGT (Wet Bulb Globe Temperature), Black Globe (TG) temperature, humidity, wet bulb, dew point and air temperatures
- Adjustable audible WBGT alarm setting
- Real time data logger with integral SD memory card (IC495 optional)
- Temperature is measured in °C or °F



### SPECIFICATIONS

**Indoor WBGT Range:** 0° to 59 °C

**Outdoor WBGT Range:** 0° to 56 °C

**TG Temp. Range:** 0° to 80 °C

**Air Temp. Range:** 0° to 50 °C

**Humidity Range:** 5 % to 95 % RH

**Model No. IC502**

**Mfg. No. R6250SD**

**Price/Each \$539.00**

**REED**

## HEAT STRESS STOP WATCH

- Measures temperature and humidity, and calculates heat index as well as dew point
- Combines air temperature and relative humidity measurements in an attempt to determine the human-perceived equivalent temperature or "how hot it feels"
- Full LCD display with LED backlight
- Silent operation option
- Dual power: Solar panel and battery
- 1 ATM water resistant (IPX4 rated)



**Model No. IA987**

**Mfg. No. SW700**

**Price/Each \$59.00**

**REED**

## COOLING BANDANAS

- Helps fight heat stress and fatigue
- Soak 2-5 minutes in water to activate
- Remains hydrated for at least 4 hours
- Just re-wet to reactivate the cooling beads
- One size fits all
- Material: Cotton



Model No.	Colour	Price/Each
SGO333	Blue	3.95
SGO334	Red	3.95

**ZENITH®**  
Safety Products

## CHILL-ITS® 6700CT COOLING BANDANAS & 6710CT COOLING TRIANGLE HATS

- Advanced PVA towel material keeps you cool without the bulk
- Activates quickly and easily when run under water for one minute
- Lightweight and low profile for use with hard hats and helmets
- Tie closure for personal fit
- Reusable, just re-soak
- One size



SEI648

Model No.	Mfg. No.	Colour	Price/Each
-----------	----------	--------	------------

### BANDANAS

SEC683	12566	Hi-Vis Lime	7.63
SGP160	12569	Skulls	7.63
SEI645	12562	Camouflage	7.63
SEI646	12563	Red Western	7.63
SEI647	12564	Navy Western	7.63
SEI648	12568	Flames	7.63



SEC685

### TRIANGLE HATS

SEC685	12586	Hi-Vis Lime	16.90
SGS355	12589	Skulls	16.90
SEI649	12582	Camouflage	16.90
SEI650	12583	Red Western	16.90
SEI651	12584	Navy Western	16.90
SEI652	12588	Flames	16.90



## CHILL-ITS® 6700 COOLING BANDANAS & 6710 COOLING TRIANGLE HATS

- Soak in cold water to activate
- Remains hydrated up to four hours
- Activated cooling polymers bring cooling power where you need it most to fight heat stress and fatigue
- Reusable, just re-soak



SGP152

Model No.	Mfg. No.	Colour	Price/Each
-----------	----------	--------	------------

### BANDANAS

SEB128	12306	Navy Western	3.65
SEB134	12304	Camouflage	3.65
SGP151	12565	Black	7.63
SGP152	12329	Skulls	3.65
SEB139	12341	Flames	3.65

### TRIANGLE HATS

SAP942	12326	Navy Western	8.44
SAP941	12325	Red Western	8.44
SAP943	12324	Camouflage	8.44



SAP942





# HEAT STRESS PREVENTION

## CHILL-ITS® 6602 COOLING TOWELS

- Dampen this synthetic space age towel to create a cooling aid significantly cooler than ambient air
- Advanced PVA material holds water without feeling heavy
- Super-evaporative, reduces the effect of heat stress and fights fatigue
- Wear for hours, or wipe for quick relief
- Simply re-wet the towel to reactivate
- Machine washable

SEB126



Model No.	Mfg. No.	Colour	Price/Each
SEB126	12420	Blue	11.70
SEI753	12439	Hi-Vis Lime	11.70
SEI754	12441	Orange	11.70
SEI755	12442	Pink	11.70
SEI756	12438	Grey	11.70

## CHILL-ITS® 6602MF MICROFIBER COOLING TOWELS

- Microfibre material is soft and absorbent
- Super-evaporative, feels significantly cooler than ambient air
- Non toxic and chemical free
- Machine washable
- 2-sided colour, grey on reverse
- Size: 9.8" x 40.9"
- UPF 50 for protection against harmful UV

SDL619



SDL618



Model No.	Mfg. No.	Colour	Price/Each
SDL618	12660	Blue	18.30
SDL619	12668	Black	18.30
SDL620	12669	Hi-Vis Lime	18.30
SDL621	12661	Orange	18.30

## CHILL-ITS® 6665 WET EVAPORATIVE COOLING VESTS

- Soak in cold water 2-5 minutes to activate
- Enjoy cooling relief and comfort for up to four hours
- V-neck with zipper closure
- Quilted nylon outer layer
- Activated, polymer-embedded fabric inside
- Water-repellent liner and black cotton-poly elastic trim
- Lightweight, durable and washable
- 100% nylon
- Reusable, just re-soak

SAP936



SEC688



Model No.	Mfg. No.	Size	Price/Each
<b>HI-VIS LIME-YELLOW</b>			
SAP936	12533	Medium	77.50
SAP937	12534	Large	77.50
SAP938	12535	X-Large	77.50
SAP939	12536	2X-Large	77.50
SEC687	12537	3X-Large	77.50

Model No.	Mfg. No.	Size	Price/Each
<b>GREY</b>			
SEC688	12543	Medium	77.50
SEC689	12544	Large	77.50
SEC690	12545	X-Large	77.50
SEC691	12546	2X-Large	77.50
SEC692	12547	3X-Large	77.50

## CHILL-ITS® 6717 HARD HAT PADS & SHADES

- Soak in cold water 2-5 minutes to activate
- Remains hydrated up to four hours
- Conveniently attaches to standard hard hat suspension with hook and loop closures
- Activated cooling polymers bring cooling power where you need it most to fight heat stress and fatigue
- Protects neck from harmful UV rays
- Reusable, just re-soak

Model No. SAP940  
Mfg. No. 12336  
Price/Each \$7.93



## CHILL-ITS® 6700FR COOLING BANDANAS

- Modacrylic cotton blend fabric
- Soak in water 2-5 minutes to activate
- Remains hydrated for up to four hours
- Meets ASTM F2302 for flame resistance
- Fabric meets ASTM F1506 performance requirements
- ATPV rating: 7.1 cal/cm², CAT 1

SEI655



Model No.	Mfg. No.	Colour	Price/Each
SEI655	12601	Hi-Vis Lime	9.68
SEI656	12607	Blue	9.68

**COLOURS & PATTERNS**  
All colours not necessarily available in all styles.



## CHILL-ITS® 6685 DRY EVAPORATIVE COOLING VESTS

- Provides immediate and long lasting cooling
- Up to 3 days of cooling ability each time the vest is filled
- Easy to use watertight filling cap
- Fill with 13-20 oz. (400-600 ml) of water to activate
- Lightweight, durable and washable
- V-neck with zip closure
- Mesh side panels provide additional ventilation and stretch
- Patented • Colour: Lime
- Do not clean the inside reservoir; cooling material is treated with an anti-microbial that inhibits mold growth
- Keep cap closed at all times to maintain effectiveness



Model No.	Mfg. No.	Size	Price/Each
SDN598	12673	Medium	308.00
SDN599	12674	Large	308.00
SDN600	12675	X-Large	308.00
SDN601	12676	2X-Large	308.00
SDN602	12677	3X-Large	308.00
SGS356	12678	4X-Large	308.00

## CHILL-ITS® 6687 ECONOMY DRY EVAPORATIVE COOLING VESTS

- Exclusive patented dry technology keeps wearer completely dry and comfortable during the entire evaporative cooling process
- Up to 3 days of cooling power to help maintain a healthy body temperature
- Fill vest with 13.5oz - 15.5oz / 400ml - 450ml of water
- Made of industrial grade quality nylon and elastic wrap waist closure
- Cooling material is treated with an anti-microbial that prevents mold growth
- Reduces the effect of heat exhaustion and fights fatigue while working or playing in the summer outdoor heat
- Colour: Hi-Vis Lime



Model No.	Mfg. No.	Size	Price/Each
SG0695	12683	Small/Medium	219.00
SG0696	12685	Large/X-Large	219.00

## CHILL-ITS® 6670CT COOLING NECK SHADES

- Advanced PVA material activates easily and quickly when run under water for one minute
- Super-evaporative cooling process helps keep you cool
- Hook and loop straps for easy attachment
- Re-usable, just re-soak
- Patented design

Model No. SEI653  
Mfg. No. 12523  
Price/Each \$30.30



## 6215 & 6215HV PHASE CHANGE COOLING VESTS

- Maintains constant 64°F / 18°C
- Cooling lifecycle lasts up to four hours
- Comfortable cotton construction with hook & loop closure
- Extended vest surface area to enhance cooling power
- Non-toxic, non carcinogenic, dielectric substance
- Elastic pen loop
- Modacrylic cotton blend FR fabric meets ASTM F1506 performance requirements
- ATPV rating: 7.1 cal/cm<sup>2</sup>, CAT 1



Model No.	Mfg. No.	Colour	Size	Price /Each
SDN603	12200	Khaki	Small/Medium	564.00
SDN604	12210	Khaki	Large/X-Large	564.00
W/REFLECTIVE ACCENTS				
SDN605	12220	Orange	Small/Medium	582.00
SDN606	12221	Orange	Large/X-Large	582.00

## SHAX® 6000 HEAVY-DUTY WORK TENTS

- Versatile and durable instant shelter provides fast, long lasting relief from the sun, wind, and rain
- 300D polyester top with polyurethane and UV coatings
- Powder coated tenacious steel frame
- ABS plastic sliders for convenient height adjustment
- 10' x 10' foot-print, peak height 14'
- Double vented top for maximum airflow
- Reflective accents and reinforced corners
- Includes: Heavy-duty ground stakes, ropes and wheeled bag for easy transport and storage
- Meets CPAI-84 flame resistance standard
- Optional side panel available



Model No.	Mfg. No.	Description	Price /Each
SEC718	12900	Tent, High Visibility Lime	698.00
SEC719	12998	Side Panel, High Visibility Lime	90.40
SHB418	12978	Sidewall with Zipper	105.00
SHB421	12989	Sidewall with Mesh Window	99.20
SEI654	12994	Tent Weights	81.50

\*Also available in blue

## SHAX® 6010 LIGHT-WEIGHT TENTS

- Instant pop-up shelter provides fast relief from elements at a cost effective price
- 210D polyester top with PU coating
- Hammer tone steel frame
- Pull pin sliders for convenient height adjustment between 10'-14' (3.05 m - 4.27 m)
- 10' x 10' (3 m x 3 m) foot print, peak height of 14' (4.27 m)
- Reinforced corners
- Wheeled storage bag
- Meets CPAI-84 flame resistance standard
- Colour: High Visibility Lime
- Weight: 44 lbs.
- Optional side panel available



Model No.	Mfg. No.	Description	Price /Each
SEJ785	12910	Tent	512.00
SEC719	12998	Side Panel	90.40
SHB418	12978	Sidewall with Zipper	105.00
SHB421	12989	Sidewall with Mesh Window	99.20
SEI654	12994	Tent Weights	81.50



## ABSORPTIVE SERIES

Ergodyne's Chill-It's® Absorptive Series cooling products sop up sweat, and provide cooling relief. Keeping sweat off your eyes and hands is not only smart, it's safe.

## CHILL-ITS® 6605 COOLING HEADBANDS & 6615 COOLING DEW RAGS

- Hi Cool® moisture management performance fabric transports moisture away
- Absorbent terrycloth band
- Machine washable



Model No.	Mfg. No.	Colour	Price /Each
HEADBANDS			
SEC694	12425	Solid Blue	11.40
SEL847	12431	High Visibility Lime-Yellow	11.40
DEW RAGS			
SEC675	12481	Solid Blue	13.20
SEC676	12478	Camouflage	13.20
SEC678	12485	Flames	13.20
SEC680	12480	Navy Western	13.20



COLOURS & PATTERNS  
All colours not necessarily available in all styles.



## CHILL-ITS® 6660 HARD HAT BRIMS

- 100% polyester fabric
- Universal design - elastic inner rim to fit most hard hats
- Blocks the sun's rays keeping workers comfortable in environments absent from other forms of shade
- Patented



Model No.	Mfg. No.	Colour	Price /Each
SEI751	12640	Hi-Vis Lime	19.60
SEI752	12641	Hi-Vis Orange	19.60

## CHILL-ITS® 6650 COOLING HATS WITH NECK SHADES

- Hi Cool® moisture management performance fabric transports moisture away
- Absorbent terrycloth headband
- Wide panel neck protection
- Adjustable cinch cord for a great fit



Model No.	Mfg. No.	Colour	Price /Each
SEC712	12520	Hi-Vis Lime	31.90
SEC713	12521	Hi-Vis Orange	31.90

## CHILL-ITS® 5155 & 5155HV LOW-PROFILE HYDRATION PACKS

- Keeps workers hydrated when they are away from water sources
- Durable 600D water-resistant rip stop polyester shell
- Zip-up cap cover keeps debris and contaminants at bay
- Insulated pack and tube keeps water cool
- 100% anit-microbial Microban® bite valve
- Bite valve cover for protection from contaminants
- Breakaway shoulder straps for extra security
- DualCap bladder featuring smaller (60 mm) cap nestled into large (80 mm) cap for easy water and ice filling
- Capacity: 2 litres



Model No.	Mfg. No.	Colour	Price /Each
SEC701	13155	Black	102.00
SEC702	13156	Hi-Vis Lime	113.00
SEM748	13157	Hi-Vis Orange	113.00



# HEAT STRESS PREVENTION

## SQWINCHER® LIQUID CONCENTRATE

- Yields large quantities to cover your whole crew
- Mixes instantly when water is added – no stirring required
- Screw-on cap allows you to reseal the bottle



Model No.	Mfg. No.	Flavour	Package Size oz.	Package Yield gal.	Price /Each
SAF862	11025	Grape	64	5	36.70
SAP552	11027	Mixed Berry	64	5	36.70
SR933	11020	Lemonade	64	5	36.70
SR934	11021	Orange	64	5	36.70
SR935	11022	Fruit Punch	64	5	36.70
SR936	11023	Lemon Lime	64	5	36.70
SR937	11024	Tropical Cooler	64	5	36.70

## SQWINCHER® FAST PACK®

- Packet can be used as a drinking cup; simply open it and add water to fill
- Handy, portable size lets you take Sqwincher® almost anywhere



Model No.	Mfg. No.	Flavour	Packet Size oz.	Packet Yield oz.	Qty /Box	Price /Each
SAF872	11080	Lemonade	0.6	6	50	55.30
SAF873	11081	Fruit Punch	0.6	6	50	55.30
SAF874	11082	Lemon-Lime	0.6	6	50	55.30
SAF878	11086	Orange	0.6	6	50	55.30

## SQWINCHER® SQWEEZE FREEZER POPS

- The great taste and performance of Sqwincher® in a refreshing frozen treat
- Simply freeze each package, then Sqweeze!



Model No.	Mfg. No.	Flavour	Package Size oz.	Package Yield	Qty /Box	Price /Each
SAM804	11130	Various*	3	3-oz. Popsicle	150	208.00

\* Mixed case consists of orange, grape, lemon-lime, cherry and mixed berry flavours.

## SQWINCHER ZERO® LIQUID CONCENTRATE

- Solution formulated for diabetics or consumers watching their daily carbohydrate intake
- Get the same benefits as regular Sqwincher® without any calories or sugar
- Yields large quantities to cover your whole crew
- Mixes instantly when water is added – no stirring required
- Screw-on cap allows you to reseal the bottle



Model No.	Mfg. No.	Flavour	Package Size oz.	Package Yield gal.	Price /Each
SAN533	11050502-FP	Fruit Punch	64	5	32.60
SAN534	11050504-LL	Lemon-Lime	64	5	32.60
SAN536	11050507-OR	Orange	64	5	32.60

## SQWINCHER ZERO® QWIK STIK™

- Calorie and sugar free single-serve pouches
- Simply tear open the pouch, pour the powder into a 20-oz. bottle of water, and shake



Model No.	Mfg. No.	Flavour	Pouch Size oz.	Pouch Yield oz.	Qty /Box	Price /Each
SAN505	11060100-OR	Orange	0.11	20	50	71.40
SAN506	11060102-FP	Fruit Punch	0.11	20	50	71.40
SAP496	11060101-MB	Mixed Berry	0.11	20	50	71.40
SEI282	11060453-SL	Strawberry Lemonade	0.11	20	50	71.40

## SQWINCHER LITE QWIK STIK™ KWIK PAK™

- Plastic container has a snap lock and hold four of each flavour of the Qwik Stiks
- Ideal size fits almost anywhere including pockets, glove compartments, first aid kits, tool boxes and vending machines
- Multiple flavours help to reduce flavour fatigue to ensure the worker enjoys the drink and hydrates properly
- Can be refilled from the 50 Qwik Stik bag, controlling consumption
- Calorie and sugar free single-serve pouches
- Simply tear open the pouch, pour the powder into a 20-oz. bottle of water and shake
- Cost effective and convenient for people on the go
- Each Qwik Pak contains 16 assorted 0.11 oz. Qwik Stiks, yielding 20 oz. each



Model No.	Mfg. No.	Price /Each
SEI283	110WKP-MF	28.70



# FIRE EXTINGUISHING PRODUCTS

## FOAM FIRE EXTINGUISHERS

- Rapidly and efficiently puts out the fire by covering and cooling the flames at the source
- Lightweight, easy to handle and highly effective to instantly put out any incipient fire
- Can be safely used on electrical and grease fire
- Foam will not damage equipment and is completely safe for both the health and the environment
- Non-toxic; contact with the skin is completely harmless
- Comes ready to use with glow-in-the-dark fluorescent stand
- Reusable until the can is empty
- The foam formula cleans easily
- 3 to 5 years service life
- Type: Class A/Class B/Class C/Class K
- Standard(s) Met: None
- Not for sale in the province of Alberta, does not meet provincial law

Model No.	Mfg. No.	Capacity lbs.	Rating	Length"	Dimensions Width"	Height"	Discharge Duration	Price /Each
SGC460	REI500SUP	1.5	3A 13B C K	2.8	x 3	x 9.75	19 Seconds	40.80
SGC461	REI750SUP	2	3A 21B C K	3.25	x 3.5	x 12.5	25 Seconds	52.50

SGC460



## DRY CHEMICAL ABC FIRE EXTINGUISHERS

- Steel cylinder complete with cylinder skirt
- Industrial-strength cylinder has high corrosion and impact-resistant polyester powder paint finish
- Waterproof stainless steel gauge
- Anodised aluminum valve
- Strong polyester powder-coated steel handles
- Completely rechargeable
- Full hand grip for ease of operation
- UL/ULC listed

SC951  
Wall Hooks



Model No.	Mfg. No.	Cap. lbs.	Rating	Range Feet	Discharge Time Sec.	PSI	H"	Dia."	Included Bracket	Wt. lbs.	Price /Each
SAQ814	SFABC110STVB	2.5	1A:10BC	8 - 10	12-14	150	15 1/2	3 1/8	Vehicle	4 1/4	72.50
SA445	WBDL-ABC310LV	5	3A:10BC	8 - 10	13 - 14	195	16	4 1/4	Wall	10 1/2	87.90
SC946	SFABC310VB	5	3A:10BC	8 - 10	13 - 14	195	16	4 1/4	Wall & Vehicle	10 1/2	97.90
SED109*	SFABC340VB	5	3A:40BC	8 - 10	13 - 14	195	16	4 1/4	Wall & Vehicle	10 1/2	109.00
SA443	SFABC680	10	6A:80BC	10 - 15	14 - 16	235	21 1/4	5 1/8	Wall	19 1/4	149.00
SA444	SFABC1020	20	10A:120BC	10 - 15	20 - 22	235	24	7 1/8	Wall	35 1/4	269.00
SED110	SFABC30	30	10A:120BC	10 - 15	28	195	30 3/4	7 1/8	Wall	50 1/3	565.00

\*Meets requirements for forklifts



## ACCESSORIES

Model No.	Mfg. No.	Description	Fits	Price/Each	Model No.	Mfg. No.	Description	Fits	Price/Each
SC951	C160738	Wall Hook	5 lbs.	4.29	SA442	UP2	Vehicle Bracket	2.5 lbs.	8.09
SC952	C160752	Wall Hook	10 lbs.	4.39	SC955	UB5	Vehicle Bracket	5 lbs.	9.79
SC953	C160791	Wall Hook	20 lbs.	4.59	-	-	-	-	-

## ALUMINUM CYLINDER CARBON DIOXIDE (CO<sub>2</sub>) FIRE EXTINGUISHERS

- Well suited for corrosive environments
- Industrial-strength aluminum cylinder is up to 30% lighter than steel
- Stainless steel hose band
- Strong impact-resistant horn
- Bar-coded label
- Easy to service
- Comes with wall hook
- ULC listed



Model No.	Mfg. No.	Cap. lbs.	Rating	Range Feet	Discharge Time Sec.	H"	Dia."	Wt. lbs.	Price /Each
SAJ098	SF-5CO2	5	5BC	6-12	10	17 1/4	5 3/4	13 1/4	365.00
SAJ099	SF-10CO2	10	10BC	6-12	10	19 3/4	6 3/4	27	555.00
SAJ100	SF-15CO2	15	10BC	6-12	15	26 3/4	6 3/4	37	735.00
SAL344	SF-20CO2	20	10BC	6-12	20	26 3/4	8	48 1/8	749.00

## ACCESSORIES

Model No.	Mfg. No.	Description	Fits	Price/Each	Model No.	Mfg. No.	Description	Fits	Price/Each
SAM953	SF5WH	Wall Hook	5 lbs.	3.39	SAP900	HDVB-2	Vehicle Bracket	5 lbs.	68.90
SAM954	SF1015WH	Wall Hook	10-15 lbs.	3.39	SAM957	HDVB-3	Vehicle Bracket	10 lbs.	76.90
SAM955	SF20WH	Wall Hook	20 lbs.	3.79	SED313	HDVB-4	Vehicle Bracket	15 lbs.	209.00



## K CLASS WET CHEMICAL EXTINGUISHERS

- Brass valve construction
- Specially designed and tested to address fires in restaurants and commercial fryers
- Very effective on cooking oil and grease fires
- Ideal for restaurants, kitchens, cafeterias, food courts, and other locations with high temperature cooking materials
- Nozzle designed to prevent splashing
- Designed to be used in conjunction with a kitchen suppression system



Model No.	Mfg. No.	Cap. Liters	Rating	Range Feet	Discharge Time Sec.	PSI	H"	Dia."	Included Bracket	Wt. lbs.	Price /Each
SED438	SF6K	6	1-A:K	10-12	60	100	21 1/2	7	Wall	25	445.00



# FIRE EXTINGUISHING PRODUCTS

## STANDARD VEHICLE & MARINE BRACKETS FOR ABC EXTINGUISHERS

- Black polyester powder-coated with stainless steel strap
- ULC listed



Model No.	Mfg. No.	Fits	Price /Each
SA442	UP2	2.5 lbs.	8.09
SC955	UB5	5 lbs.	9.79

## HEAVY-DUTY VEHICLE & MARINE BRACKETS

- Ideal for construction equipment, industrial and commercial trucks
- Corrosion-resistant
- Uni-body steel construction
- Rounded corners for added safety



Model No.	Mfg. No.	Colour	Fits ABC	Fits CO <sub>2</sub>	Price /Each
SAP900	HD-5	Red	5 lbs.	-	68.90
SAM956	HD-10	Red	10 lbs.	5 lbs.	73.50
SAM957	HD-20	Red	20 lbs.	10 lbs.	76.90
SED313	HDVB-4	Black	30 lbs.	15 lbs.	209.00

## SURFACE-MOUNTED FIRE EXTINGUISHER CABINETS

- Extinguishers are readily available while keeping them safe from potential vandals
- Complete with cylinder lock keyed alike
- Baked white enamel finish with acrylic plastic viewing panel
- Break glass hammer and chain with "break glass" sticker



Model No.	Mfg. No.	Dimensions W" x D" x H"	Accommodates	Price /Each
SAS062	C-100	8-1/2 x 6 x 20-1/2	5-lb Dry Chemical	119.00
SD028	C-999	10-9/16 x 6-9/16 x 24-5/16	10-lb Dry Chemical	155.00
SD027	C-104	14-1/8 x 9-1/16 x 30-1/8	20-lb Dry Chemical or 10-lb CO <sub>2</sub>	229.00

## MEDIUM-DUTY VEHICLE & MARINE BRACKETS FOR ABC EXTINGUISHERS

- Black polyester powder-coated with two stainless steel straps
- Ideal for forklifts, industrial equipment and warehouse retail
- ULC listed



Model No.	Mfg. No.	Fits	Price /Each
SED311	UB5-MD	5 lbs.	29.50
SED312	UP10	10 lbs.	44.90

## HEAVY-DUTY OUTDOOR EXTINGUISHER CABINETS

- 16-gauge cold-rolled steel
- Welded construction with sloped roof
- Full-length stainless steel piano hinge and weatherproof gasket around door jam
- Full metal door with keyed paddle latch
- Baked red acrylic enamel over phosphate treated steel
- Accommodates up to a 30-lb dry chemical ABC extinguisher



Model No.	Mfg. No.	Inside Dimensions W" x D" x H"	Price /Each
SAN296	OEC	14 x 10 x 28	625.00

## FIRE EXTINGUISHER CABINETS

- FT-Series polystyrene cabinets work well indoors and out
- Ultraviolet inhibitors prevent colour fading
- Each cabinet includes an injection molded frame, scored break front, plastic cam lock with key, break-front striker and screen printed pictogram



Model No.	Mfg. No.	Description	Dimensions W" x D" x H"	Weight lbs.	Price /Each
SGL076	FTC-05	5 lb Extinguisher Cabinet	8 x 6-3/8 x 19	6	83.50
SGL077	FTC-10	10 lb Extinguisher Cabinet	9 x 7 x 23	9	109.00
SGL078	FTC-20	20 lb Extinguisher Cabinet	11 x 9 x 28	12	239.00

### REPLACEMENT PARTS

SGL079	FTC-05-PF	5 lb Plexi Front & Frame	49.50
SGL080	FTC-10-PF	10 lb Plexi Front & Frame	50.90
SGL081	FTC-20-PF	20 lb Plexi Front & Frame	139.00
SGL082	FT-Hammer	Replacement Break Hammer & Wire	37.90

# FIRE EXTINGUISHING PRODUCTS

## KEY BOXES

- Durable ABS red plastic
- Unique snap-in design
- Pre-slotted mounting holes
- Printed glass, "Break Glass For Key"
- Replacement glass available
- 4 1/4" W x 1 1/4" D



Model No.	Mfg. No.	Description	Price /Each
SAG771	KB	Key Box	58.90
SAG772	RSKBC	Replacement Glass	19.90

## EMERGENCY ESCAPE LADDERS

- Quickly and easily attaches to any window
- No tools or assembly required
- Tangle-free design
- Constructed of durable and flame-resistant aluminum
- Anti-slip rungs
- Tested to 1000 lbs.
- Available in two-story (13') or three-story (25') ladder
- 5-year limited warranty



SAF946

**herbertwilliams**  
FIRE EQUIPMENT LTD.

Model No.	Mfg. No.	Length'	Price /Each
SAF946	HW2D	13	219.00
SAF947	HW3D	25	385.00

## FIRE EXTINGUISHER COVERS

- Reinforced vinyl covers fasten over wall-mounted extinguishers
- Protect valves, fittings and gauges from dust and corrosive fumes
- Hook and loop closure on back provides quick and easy removal with a quick jerk of pull handle
- Fluorescent red colour provides high visibility
- Available with or without window to check pressure gauge
- Available in English, French or bilingual



SD019

**nosredna**  
FIRE PRODUCTS

Model No.	Mfg. No.	Description	Dimensions			Fits	Price /Each
			W"	x	H"		
SD019	E-FEC10	English w/window	12	x	20	10 lbs.	27.50
SD020	E-FEC10NW	English w/out window	12	x	20	10 lbs.	27.50
SD021	E-FEC20	English w/window	16	x	25	20 & 30 lbs.	30.90
SD022	E-FEC20NW	English w/out window	16	x	25	20 & 30 lbs.	31.50
SE271	F-FEC10	French w/window	12	x	20	10 lbs.	26.90
SE272	F-FEC10NW	French w/out window	12	x	20	10 lbs.	27.50
SE273	F-FEC20	French w/window	16	x	25	20 & 30 lbs.	31.50
SE274	F-FEC20NW	French w/out window	16	x	25	20 & 30 lbs.	31.50
SD023	B-FEC10	Bilingual w/window	12	x	20	10 lbs.	24.90
SD024	B-FEC10NW	Bilingual w/out window	12	x	20	10 lbs.	24.90
SD025	B-FEC20	Bilingual w/window	16	x	25	20 & 30 lbs.	28.50
SD026	B-FEC20NW	Bilingual w/out window	16	x	25	20 & 30 lbs.	29.50

## FIRE BLANKET

- Made of 100% compact structure fibreglass fabric
- Suitable for extinguishing small fires or burning clothes
- Can be used as a radiant heat shield to aid in escaping fires
- Comes in a nylon storage bag with hanging hook
- Quick release tabs for easy use in an emergency
- Dimensions: 60" W x 71" L
- Standard(s) Met: EN1869:2019

Model No. SEL048  
Price/Each \$89.75



**ZENITH**  
Safety Products

## WATER JEL® FIRE BLANKETS

- Multipurpose fire blanket made of 100% wool, saturated with Water Jel® gel
- Packaged in a high-density, water-resistant, polyethylene case
- Size: 60" x 72"

### Uses:

- emergency burn victim care and fire protection
- to extinguish small fires
- to construct an escape route
- to shield and protect a rescuer from intense heat and flames

Model No. SAY460  
Mfg. No. 06622  
Price/Each \$485.00



SAY460

SAY461

### MOUNTING BRACKET

Model No. SAY461  
Mfg. No. 06623  
Price/Each \$199.00



# SAFETY CABINETS



## FLAMMABLE STORAGE CABINETS

- Double-wall 18-gauge welded steel construction with 1 1/2" air space
- Dual 2" capped vents with flame arrestors
- Full-height piano hinges open a full 180° for easy access
- Recessed handle
- 2" high leak proof door sill
- All shelves are adjustable on 2 1/2" centers
- Adjustable leveling feet
- Tough corrosive resistant finish
- Standard Met: FM/NFPA/OSHA
- Meets NFPA Code 30 and OSHA standard 1910 106 for storage for class I, II and III liquids



SGU465



SDN647

Model No.	Door Type	Capacity Gallons	No. of Shelves	No. of Doors	Exterior Dimensions W" x D" x H"	Price /Each
SGU465	Self-Closing	30	1	2	43 x 18 x 44	1795.00
SDN646	Manual	30	1	2	43 x 18 x 44	1460.00
SGU466	Self-Closing	45	2	2	43 x 18 x 65	2095.00
SDN647	Manual	45	2	2	43 x 18 x 65	1800.00
SGU467	Self-Closing	60	2	2	34 x 34 x 65	2425.00
SDN648	Manual	60	2	2	34 x 34 x 65	2100.00
SGU586	Manual	90	2	2	43 x 34 x 66	2785.00

### ACCESSORIES

Model No.	Type	For use with cabinet capacity	Dim. W" x D"	Price /Each
SAQ328	Extra Shelves	30 & 45 Gal. Cabinets	39 3/8 x 14	109.00
SAS574	Extra Shelves	60 Gal.	30 3/8 x 30	149.00
SGW861	Extra Shelves	90 Gal.	39 1/2 x 30	165.00
SDN844	Poly Tray	All size cabinets	15 3/4 x 14	82.00

## SPECIALTY SIZED FLAMMABLE STORAGE CABINETS

- Double-wall 18-gauge welded steel construction with 1 1/2" air space
- Dual 2" capped vents with flame arrestors
- Full-height piano hinges open a full 180° for easy access
- Recessed handle
- 2" high leak proof door sill
- All shelves are adjustable on 2 1/2" centers
- Adjustable leveling feet
- Tough corrosive resistant finish
- Meets NFPA Code 30 and OSHA standard 1910 106 for storage for class I, II and III liquids



SDN642



SDN644

Model No.	Door Type	Capacity Gallons	No. of Shelves	No. of Doors	Exterior Dimensions W" x D" x H"	Price /Each
SGU584	Manual	4	1	1	17 x 18 x 22	775.00
SGU463	Self-Closing	12	1	1	23 x 18 x 35	1270.00
SDN642	Manual	12	1	1	23 x 18 x 35	925.00
SGU585	Manual	12	1	2	43 x 18 x 18	1155.00
SDN643	Manual	16	1	1	23 x 18 x 44	1250.00
SGU464	Self-Closing	22	1	2	35 x 22 x 35	1710.00
SDN644	Manual	22	1	2	35 x 22 x 35	1360.00
SDN645	Manual	24	3	2	43 x 12 x 44	1350.00

### ACCESSORIES

Model No.	Type	For use with cabinet capacity	Dim. W" x D"	Price /Each
SEE922	Extra Shelves	12 & 16 Gal.	19 1/2 x 14	65.50
SEE923	Extra Shelves	22 Gal.	31 1/2 x 18	96.25
SEE924	Extra Shelves	24 Gal.	39 1/2 x 8	61.50
SDN844	Poly Tray	All sizes	15 3/4 x 14	82.00

## VERTICAL DRUM STORAGE CABINET

- Safely stores up to two drums, easy glide rollers for convenient drum access
- Half-depth shelf allows additional storage
- Rollers at bottom of cabinet facilitate drum movement
- Includes two polyethylene trays
- Double-wall 18-gauge welded steel construction with 1 1/2" air space
- Dual 2" capped vents with flame arrestors
- Full-height piano hinges open a full 180° for easy access
- Adjustable leveling feet
- Standard(s) Met: NFPA/OSHA/FM
- Meets NFPA Code 30 and OSHA standard 1910 106 for storage for class I, II and III liquids
- Door Type: 2 doors, manual with drum rollers
- Weight: 480 lbs.



Model No.	Drum Capacity (US)	Capacity Gallons	No. of Drums	Material	Exterior Dimensions W" x D" x H"	Price /Each
SGC540*	2-55 gallons	110	2	Steel	59 x 34 x 65	4995.00

### ACCESSORIES

SGC865	Additional Shelf for Drum Cabinet	55-5/16 x 14-1/16	165.00
--------	-----------------------------------	-------------------	--------

\*Codes state that not more than 60 gallons of Category I, II or III flammable liquids, nor more than 120 gallons of Category IV flammable liquids may be stored in a safety cabinet

## PAINT/INK CABINETS

- Double-wall 18-gauge welded steel construction with 1 1/2" air space
- Dual 2" capped vents with flame arrestors
- Full-height piano hinges open a full 180° for easy access
- Recessed handle
- 2" high leak proof door sill
- All shelves are adjustable on 2 1/2" centers
- Adjustable leveling feet
- Tough corrosive resistant finish
- Standard Met: FM/NFPA/OSHA
- Meets NFPA Code 30 and OSHA standard 1910 106 for storage for class I, II and III liquids



SDN651



SDN649

Model No.	Door Type	Capacity Gallons	No. of Shelves	No. of Doors	Exterior Dimensions W" x D" x H"	Price /Each
SDN649	Manual	20	1	1	23 x 18 x 44	1280.00
SDN650	Manual	45	3	2	43 x 18 x 44	1585.00
SDN651	Manual	60	5	2	43 x 18 x 65	2135.00
SDN652*	Manual	96	5	2	34 x 34 x 65	2625.00

\*Codes state that not more than 60 gallons of Category I, II or III flammable liquids, nor more than 120 gallons of Category IV flammable liquids may be stored in a safety cabinet

### ACCESSORIES

Model No.	Type	For use with cabinet capacity	Dim. (W" x D")	Price/Each
SEE922	Extra Shelves	12 & 16 Gal. Cabinet or 20 Gal. Paint Cabinets	19 1/2 x 14	65.50
SEE923	Extra Shelves	22 Gal.	31 1/2 x 18	96.25
SEE924	Extra Shelves	24 Gal.	39 1/2 x 8	61.50
SAQ328	Extra Shelves	60 & 96 Gal. Cabinets or 45 & 60 Gal. Paint Cabinets	39 3/8 x 14	109.00
SAS574	Extra Shelves	60 & 96 Gal.	30 3/8 x 30	149.00
SDN844	Poly Tray	22, 30 & 45 Gal. (2 trays per cabinet)	15 3/4 x 14	82.00

## CORROSIVE LIQUIDS CABINETS

- Includes two polyethylene trays
- Double-wall 18-gauge welded steel construction with 1 1/2" air space
- Dual 2" capped vents with flame arrestors
- Full-height piano hinges open a full 180° for easy access
- Recessed handle
- 2" high leak proof door sill
- All shelves are adjustable on 2 1/2" centers
- Adjustable leveling feet
- Tough corrosive resistant finish
- Standard Met: FM/NFPA/OSHA
- Meets NFPA Code 30 and OSHA standard 1910 106 for storage for class I, II and III liquids

Model No.	Door Type	Capacity Gallons	No. of Shelves	No. of Doors	Exterior Dimensions W" x D" x H"	Price /Each
SDN653	Manual	22	1	2	35 x 22 x 35	1365.00
SDN654	Manual	30	1	2	43 x 18 x 44	1760.00
SDN655	Manual	45	2	2	43 x 18 x 65	1975.00
SHI433	Self-Closing	22	1	2	35 x 22 x 35	1890.00
SHI434	Self-Closing	30	1	2	43 x 18 x 44	2020.00
SHI435	Self-Closing	45	2	2	43 x 18 x 65	2620.00

### ACCESSORIES

Model No.	Type	For use with cabinet capacity	Dim. (W" x D")	Price/Each
SEE923	Extra Shelves	22 Gal.	31 1/2 x 18	96.25
SAQ328	Extra Shelves	60 & 96 Gal. Cabinets or 45 & 60 Gal. Paint Cabinets	39 3/8 x 14	109.00
SDN844	Poly Tray	22, 30 & 45 Gal. (2 trays per cabinet)	15 3/4 x 14	82.00

## PESTICIDE STORAGE CABINETS

- Provides safe, secure and controlled storage for pesticides, insecticides, herbicides and other turf chemicals
- Includes two polyethylene trays
- Double-wall 18-gauge welded steel construction with 1 1/2" air space
- Dual 2" capped vents with flame arrestors
- Full-height piano hinges open a full 180° for easy access
- Recessed handle
- 2" high leak proof door sill
- All shelves are adjustable on 2 1/2" centers
- Adjustable leveling feet
- Tough corrosive resistant finish
- Standard Met: FM/NFPA/OSHA
- Meets NFPA Code 30 and OSHA standard 1910 106 for storage for class I, II and III liquids

Model No.	Door Type	Capacity Gallons	No. of Shelves	No. of Doors	Exterior Dimensions W" x D" x H"	Price /Each
SGD359	Manual	22	1	2	35 x 22 x 35	1365.00
SGD360	Manual	30	1	2	43 x 18 x 44	1760.00
SGD361	Manual	45	2	2	43 x 18 x 65	1975.00



SDN655



SGD361

# SAFETY CABINETS

## FLAMMABLE AEROSOL STORAGE CABINET

- 24-gauge galvanized steel roll-out shelves
- Reduce risks and protect workers by storing flammable chemicals in safety cabinets
- High-performance, self-latching doors close easily and securely for maximum protection under fire conditions
- Two fixed position shelves with (30) 2-3/4" diameter openings
- Fail-safe closing mechanism ensures three-point stainless steel bullet latching system works every time
- Handle comes with a cylinder lock and key set or accepts an optional padlock
- Warning labels are highly visible under fire conditions or during power outages when illuminated with a flashlight
- Features a leak-proof 2" bottom sump, four adjustable self-leveling feet, grounding connector and trilingual warning label
- Durable lead-free epoxy/polyester powder-coat finish provides excellent chemical resistance
- Accepts cans up to 10" tall and are removable for easy cleaning
- The cabinet can store up to 30 cans



Model No.	Door Type	Capacity Gallons	No. of Shelves	No. of Doors	Standard(s) Met	Ext. Dim. W" x D" x H"	Manufacturer's Warranty	Price /Each
SGX675	Manual	12	2	1	NFPA, OSHA	23 x 18 x 35	10-Year Limited Warranty	1995.00

## SURE-GRIP® EX FLAMMABLE STORAGE CABINETS

- Double wall welded 18-gauge steel construction with 1 1/2" of insulating air space
- Doors self-latch for easy and secure closure with 3-point stainless steel bullet latches
- U-Loc™ handle comes with 2 keys or accepts optional padlock for greater security
- Two flame arrester vents and ground wire connection screw
- 2" deep leak proof sill
- Adjustable leveler legs, and galvanized SpillSlope™ shelves that adjust on 3" centres
- Durable yellow powder coat paint finish provides long life and exceptional chemical resistance
- Haz-Alert™ reflective warning labels offer visibility under dark conditions
- Meets NFPA and OSHA requirements
- FM approved



SEG859



SAP510

SAP509



Cabinet Cover



SAQ024

Model No.	Mfg. No.	Door Type	Capacity Gallons	Adjustable Shelves	Ext. Dim. W" x D" x H"	Wt. lbs.	Price /Each
SAP509	893000	2 Doors, Manual	30	1	43 x 18 x 44	193	2006.00
SAQ020	893080	Sliding, Self-Closing	30	1	43 x 18 x 44	224	3164.00
SAQ021	893020	2 Doors, Self-Closing	30	1	43 x 18 x 44	198	2371.00
SAP510	894500	2 Doors, Manual	45	2	43 x 18 x 65	266	2626.00
SAQ022	894580	Sliding, Self-Closing	45	2	43 x 18 x 65	305	4469.00
SAQ023	894520	2 doors, Self-Closing	45	2	43 x 18 x 65	272	3039.00
SAQ024	896000	2 Doors, Manual	60	2	34 x 34 x 65	328	3021.00
SAQ025	896020	2 doors, Self-Closing	60	2	34 x 34 x 65	330	3575.00
SAQ026*	899000	2 Doors, Manual	90	2	43 x 34 x 65	390	3754.00
SAQ027*	899020	2 doors, Self-Closing	90	2	43 x 34 x 65	383	4469.00

\*Codes state that not more than 60 gallons of Category I, II or III flammable liquids, nor more than 120 gallons of Category IV flammable liquids may be stored in a safety cabinet

## SURE-GRIP® EX HIGH SECURITY FLAMMABLE SAFETY CABINETS

- The same durable construction as Justrite's regular Sure-Grip® cabinet with added layers of security
- Safely store and protect costly fuels or chemicals from tampering or theft
- Security system includes 1/4" x 2" steel bar stock, a high visibility barrier bar secured across both doors
- Crossbar is firmly supported by two brackets welded across the front of the cabinet doors and interlocks onto two sidewall brackets
- Padlock lugs on crossbar and side bar channel accept 2 x No. 5 Master Lock™ keyed-alike (SR867, sold separately)
- Lockable doors with Sure-Grip® handle are designed with a three-point latch for an extra measure of security
- Capacity: 45 gallons
- FM approved



Support brackets are firmly welded to cabinet door for extra tamper resistance.



Contrasting crossbar can be completely removed from the cabinet when not in use.



Model No.	Mfg. No.	Door Type	Adjustable Shelves	W" x D" x H"	Price /Each
SAN578	29884Y	2 Doors, Manual, Yellow	2	43 x 18 x 65	3432.00
SAN605	SC29884Y	2 Doors, Self-Close, Yellow	2	43 x 18 x 65	4112.00
SAN580	29884R	2 Doors, Manual, Red	2	43 x 18 x 65	3754.00
SAN607	SC29884R	2 Doors, Self-Close, Red	2	43 x 18 x 65	4290.00



SAN578



## SURE-GRIP® EX SPECIALTY CABINETS

### STORE SMALLER QUANTITIES NEARBY!

When storing smaller quantities of flammable liquids at a work station or adding to existing storage capacities, specialty cabinets make it possible to store flammables safely even when available space is at a minimum. These cabinets offer U-Loc™ handles and come with a double key set or accept an optional padlock for greater security. Chemical resistant powder coat paint resists corrosion for years of service. They also have Haz-Alert™ reflective warning labels to offer visibility under dark conditions. Meet NFPA and OSHA regulations.

#### MINI SAFETY CABINETS

- Offers the smallest footprint
- Hold small quantities of flammables for cleaning and maintenance at point-of-use
- Three bungee cords keep contents in place during transportation on service vehicles or carts

#### COUNTERTOP & COMPAC SAFETY CABINETS

- Improved access to often used liquids, without compromising safety
- Portable size keeps work areas flexible

#### SLIMLINE SAFETY CABINETS

- Small footprint allows placement almost anywhere

#### STACKABLE PIGGYBACK CABINETS

- Can be used singly or stacked to provide expanded or segregated storage
- Suitable for wall mounting or countertop
- Wall brackets not included

#### WALL MOUNT SAFETY CABINETS

- Store small containers without taking up extra floor space
- Mounts easily with furnished brackets

#### UNDERCOUNTER SAFETY CABINETS

- Designed to fit under most counters
- Designed with a kick plate to match existing casework



Model No.	Mfg. No.	Cabinet Type	Door Type	Capacity Gallons	Adjustable Shelves	Ext. Dim. W" x D" x H"	Listing /Approvals	Wt. lbs.	Price /Each
SEG862	890200	Mini	1 Door, Manual	Aerosols	1	17 x 8 x 22	-	23	1081.00
SAQ034	890400	Countertop	1 Door, Manual	4	1	17 x 17 x 22	-	54	1197.00
SAQ030*	891300	Piggyback	2 Doors, Manual	12	-	43 x 18 x 18	FM	99	1701.00
SAQ036	891200	Compac	1 Door, Manual	12	1	23 1/4 x 18 x 35	FM	103	1494.00
SAQ037	891220	Compac	1 Door, Self-Closing	12	1	23 1/4 x 18 x 35	FM	100	1898.00
SAQ031*	891700	Piggyback	2 Doors, Manual	17	1	43 x 18 x 24	FM	124	1954.00
SAQ040	893400	Wall Mount	2 Doors, Manual	20	5	43 x 12 x 44	FM	189	2298.00
SAQ041	892300	Undercounter	2 Doors, Manual	22	1	35 x 22 x 35	FM	163	1988.00
SAQ032	892200	Slimline	1 Door, Manual	22	3	23 1/4 x 18 x 65	FM	176	2188.00
SAQ033	892220	Slimline	1 Door, Self-Close	22	3	23 1/4 x 18 x 65	FM	178	2590.00

#### EXTRA SHELVES

Model No.	Mfg. No.	Description	Wt. lbs.	Price /Each
SAQ043	29936	12 and 15-Gallon Compac Cabinets	4	129.00
SAQ044	29939	22-Gallon Undercounter Cabinets	7	227.00

\*Piggyback cabinets are not to be used with sliding door cabinets.

## SURE-GRIP® EX PAINT & INK SAFETY STORAGE CABINETS

Separate and identify Class III combustibles in high performance paint and ink safety storage cabinets. They have the same safety and quality features and options that are available in Justrite's safety cabinets for flammables with additional shelves.

- Multiple shelves are ideal for 1-gallon paint cans (Class III liquids)
- Cabinets are available in 20, 40, 60 and 96-gallon capacities
- U-Loc™ handle comes with double key set or accepts optional padlock for greater security
- Haz-Alert™ reflective warning labels offer visibility under dark conditions
- Durable red powder coat paint finish easily identifies contents and is highly chemical resistant
- Meets NFPA and OSHA regulations
- FM approved

Model No.	Mfg. No.	Door Type	Capacity Gallons	Adjustable Shelves	Ext. Dim. W" x D" x H"	Wt. lbs.	Price /Each
SAQ079	891511	1 Door, Manual, Compac	20	2	23 1/4 x 18 x 44	116	2079.00
SAQ080	891531	1 Door, Self-Closing, Compac	20	2	23 1/4 x 18 x 44	139	2553.00
SAQ081	893011	2 Doors, Manual	40	3	43 x 18 x 44	240	2462.00
SAQ082	893091	Sliding, Self-Closing	40	3	43 x 18 x 44	236	3754.00
SAQ083	893031	2 Doors, Self-Closing	40	3	43 x 18 x 44	245	2827.00
SAQ084	894511	2 Doors, Manual	60	5	43 x 18 x 65	265	3129.00
SAQ085	894591	Sliding, Self-Closing	60	5	43 x 18 x 65	313	4641.00
SAQ086	894531	2 Doors, Self-Closing	60	5	43 x 18 x 65	268	3754.00
SAQ087*	896011	2 Doors, Manual	96	5	34 x 34 x 65	334	3754.00
SAQ088*	896031	2 Doors, Self-Closing	96	5	34 x 34 x 65	336	4290.00

#### ACCESSORIES

Model No.	Mfg. No.	Description	Dimensions"	Price /Each
SAP839	29937	Extra Shelf for 40-Gallon Cabinets	39 3/8 x 14	180.00
SAQ028	29944	Extra Shelf for 60-Gallon Cabinets	30 3/8 x 29	300.00
SAR311	84000	Seismic Bracket Kit to Secure Cabinet to Wall	48	455.00
SAR313	84001	Rolling Cart for 40-Gallon Cabinet	18 1/4 x 43	1040.00

\*Codes state that not more than 60 gallons of Category I, II or III flammable liquids, nor more than 120 gallons of Category IV flammable liquids may be stored in a safety cabinet



SAQ084



SAQ081



# SAFETY CABINETS

## SURE-GRIP® EX AEROSOL CAN BENCHTOP CABINETS

- Fits virtually anywhere
- Double-wall, 18-gauge welded steel with 1 1/2" of insulating air space
- 24-gauge galvanized steel roll-out shelves with stop-guard protection
- Two fixed position shelves have twelve 2 3/4" dia. openings and accept cans up to 10" tall
- Shelves are removable for easy cleaning
- U-Loc™ handle comes with double key set or accepts optional padlock for greater security
- Haz-Alert™ reflective warning labels
- Durable yellow powder coat paint finish
- Meets NFPA and OSHA regulations



**Justrite™**

**10 Year**  
Limited Warranty

Model No.	Mfg. No.	Door Type	Capacity	Ext. Dim.			Wt. lbs.	Price /Each		
				W"	x	D"			x	H"
SAQ045	890500	1 Door, Manual	24 Aerosol Cans	21	x	18	x	27	91	2717.00

## DRUM STORAGE SURE-GRIP® EX SAFETY CABINETS

Suitable for storage of larger quantities of flammable liquids and have all the same features as Justrite's standard safety cabinets.

### SURE-GRIP® EX VERTICAL DRUM STORAGE CABINETS

- Safely store one or two 30 to 55-gallon US drums
- Half-depth shelf allows additional storage of Class III flammables
- Accommodates drums equipped with pumps or funnels so cabinet can be used for waste accumulation or as a pumping station
- Rollers at bottom of cabinet facilitate drum movement
- Ramp for drum cabinets (sold separately) aids in loading drums with a hand truck

### SURE-GRIP® EX HORIZONTAL DRUM STORAGE CABINETS

- Designed to house drums being used for gravity flow dispensing
- Interior provides room for a drip can and includes tracks to guide a cradle into position. Drum cradle is not included

### SURE-GRIP® EX DOUBLE-DUTY SAFETY CABINET

- Combines vertical drum and safety storage into one partitioned cabinet
- Safely stores up to twelve 5-gallon US safety cans on the left side, and one vertical 30 or 55-gallon US drum on the right side
- Both compartments have an independently self-latching, locking door for maximum protection under fire conditions

SAQ046



SAQ052



SAQ053



**Justrite™**

**10 Year**  
Limited Warranty

Model No.	Mfg. No.	Door Type	Drum US Cap.	Ext. Dim.			Listings & Approvals	Wt. lbs.	Price /Each	
				W"	x	D"				x
<b>VERTICAL DRUM STORAGE CABINETS</b>										
SAQ046	896260	2 Doors, Manual	1-55 Gallons	34	x	34	x	65	391	3754.00
SAQ047	896270	2 Doors, Self-Close	1-55 Gallons	34	x	34	x	65	393	4469.00
SAQ048*	899160	2 Doors, Manual	2-55 Gallons	59	x	34	x	65	661	6299.00
SAQ049	899060	2 Doors, Manual	2-30 Gallons	43	x	34	x	65	476	4641.00
SAQ050	899070	2 Doors, Self-Close	2-30 Gallons	43	x	34	x	65	478	5470.00
<b>HORIZONTAL DRUM STORAGE CABINETS</b>										
SAQ051	899300	2 Doors, Manual	1-55 Gallons	30	x	48	x	50	361	4290.00
SAQ052	899320	2 Doors, Self-Close	1-55 Gallons	30	x	48	x	50	363	4807.00
<b>DOUBLE-DUTY SAFETY CABINETS</b>										
SAQ053	899260	2 Doors, Manual	1-55 Gallons	59	x	34	x	65	672	7956.00
SAQ054	899270	2 Doors, External Self-Close	1-55 Gallons	59	x	34	x	65	674	10111.00
<b>ACCESSORIES</b>				<b>Capacity lbs.</b>		<b>Dimensions*</b>				
SAI480	25932 Drum Ramp for all Justrite® Drum Cabinets -				24	x	24 1/2		35	1247.00
SAK286	25989 Cabinet Cover for SAQ046 and SAQ047 -				-		-		58	1916.00
SEE311	25920 Drum Rollers for Single Drum Vertical Cabinets			1250	29 1/2	x	30		54	970.00
SEE312	25922 Drum Rollers for Double Drum Vertical Cabinets			2000	55 1/2	x	30		96	1802.00

\*Codes state that not more than 60 gallons of Category I, II or III flammable liquids, nor more than 120 gallons of Category IV flammable liquids may be stored in a safety cabinet

## SURE-GRIP® EX HAZARDOUS MATERIAL SAFETY CABINETS

- Double-wall construction, dual vents, grounding wire connections, adjustable shelves, leak-proof sills, three-point self-latching doors and leveling feet
- Self-close doors shuts and latches automatically when a fusible link melts at 165 °F (74 °C) under fire conditions
- Unique, concealed self-closing mechanism offer obstruction-free access to contents
- Includes polyethylene trays that sit on top of galvanized steel shelves and a separate polyethylene liner for the bottom sump to resist aggressive chemicals
- Liner can easily be removed for quick cleaning of drips and leaks
- All epoxy baked-on powder-coat finish, inside and out, provides increased chemical resistance
- Cabinet comes with a "Hazardous - Keep Fire Away" label, as well as a pack of ten application-specific labels to choose from and apply to the cabinet in order to indicate its contents
- FM approved

### COUNTERTOP & COMPAC CABINETS

- Countertop and compact cabinets let you customize your work area and make the most of available space

### PIGGYBACK CABINETS

- Designed to mount on top of standard 30- and 45-gallon safety cabinets
- Piggyback cabinets create a safe storage space without taking up any valuable floor space or can also be used independently as a wall-mount unit or on a countertop

### SLIMLINE CABINETS

- Ideal for areas with limited floor space or to expand current storage conditions

### UNDERCOUNTER CABINETS

- Undercounter safety cabinets allows for storage under a workbench or lab counter for quick and easy access

SEL025



SEL029



SEL036



SEL034



SEL032



SEL030



**10 Year**  
Limited Warranty

Model No.	Mfg. No.	Capacity Gallons	Adjustable Shelves	No. of Doors	Ext. Dim.			Int. Dim.			Price /Each				
					W"	x	D"	x	H"	W"		x	D"	x	H"
<b>STANDARD</b>															
SEL025	863028	30	1	2	43	x	18	x	44	39 1/2	x	14.562	x	39 5/8	2986.00
SEL026	864528	45	2	2	43	x	18	x	65	39.5	x	14.562	x	60 1/2	3933.00
SEL027	866028	60	2	2	34	x	34	x	65	30 3/4	x	30.34	x	60 1/2	4559.00
SEL028*	869028	90	2	2	43	x	34	x	65	43	x	30	x	60 1/2	5304.00
<b>COUNTERTOP</b>															
SEL029	860428	4	1	1	17	x	17	x	22	13 3/4	x	13 3/4	x	18 1/2	1813.00
<b>COMPAC</b>															
SEL030	861228	12	1	1	23 1/4	x	18	x	35	20	x	14.562	x	30 1/2	2371.00
SEL031	861528	15	1	1	23 1/4	x	18	x	44	20	x	14.562	x	39 5/8	2571.00
<b>PIGGYBACK</b>															
SEL032	861328	12	0	2	43	x	18	x	18	39 1/2	x	14.562	x	13	2462.00
SEL033	861728	17	1	2	43	x	18	x	24	39 1/2	x	14.562	x	19 1/2	2899.00
<b>SLIMLINE</b>															
SEL034	862228	22	3	1	23 1/4	x	18	x	65	20	x	14.562	x	60.5	3236.00
SEL035	865428	54	3	1	23 1/4	x	34	x	65	20	x	30.34	x	60.5	4973.00
<b>UNDERCOUNTER</b>															
SEL036	862328	22	1	2	35	x	22	x	35	31 3/4	x	18 3/4	x	27 3/8	3146.00

\*Codes state that not more than 60 gallons of Category I, II or III flammable liquids, nor more than 120 gallons of Category IV flammable liquids may be stored in a safety cabinet



# SAFETY CABINETS



## CORROSIVE LIQUIDS CABINETS

- Includes two polyethylene trays
- Double-wall 18-gauge welded steel construction with 1 1/2" air space
- Dual 2" capped vents with flame arrestors
- Full-height piano hinges open a full 180° for easy access
- Recessed handle
- 2" high leak proof door sill
- All shelves are adjustable on 2 1/2" centers
- Adjustable leveling feet
- Tough corrosive resistant finish
- Standard Met: FM/NFPA/OSHA
- Meets NFPA Code 30 and OSHA standard 1910 106 for storage for class I, II and III liquids



SDN653

### ACCESSORIES

Model No.	Door Type	Capacity Gallons	No. of Shelves	No. of Doors	Exterior Dimensions W" x D" x H"	Price /Each
SDN653	Manual	22	1	2	35 x 22 x 35	1365.00
SDN654	Manual	30	1	2	43 x 18 x 44	1760.00
SDN655	Manual	45	2	2	43 x 18 x 65	1975.00

Model No.	Type	For use with cabinet capacity	Dim. W" x D"	Price /Each
SEE923	Extra Shelves	22 Gal.	31 1/2 x 18	96.25
SAQ328	Extra Shelves	30 & 45 Gal.	39 3/8 x 14	109.00
SDN844	Poly Tray	All size cabinets	15 3/4 x 14	82.00

## SURE-GRIP® EX ACID/CORROSIVE STORAGE CABINETS

Built to the same standards as Justrite's flammable storage cabinets with the addition of poly tray liners and a specially formulated epoxy, powder coat paint.

- Poly liners on shelves and poly sump liner are removable for easy cleaning
- 30-gallon cabinet is also equipped with a poly cabinet top work tray
- All cabinets come with the stylish flush-mounted U-Loc™ handle that offers easy fingertip access and accepts optional padlock
- Haz-Alert™ reflective warning labels
- Undercounter model has a 3 1/2" H x 2 1/2" D kick plate to mount flush with other cabinetry
- Meets NFPA and OSHA regulations
- FM approved

**Note: Not to be used with phenol, nitric and sulfuric acids.**



SAQ055

Model No.	Mfg. No.	Door Type	Capacity Gallons	Adjustable Shelves	Ext. Dim. W" x D" x H"	Wt. lbs.	Price /Each
SAQ055	892302	2 Doors, Manual, Undercounter	22	1	35 x 22 x 35	154	2535.00
SAQ056	892202	1 Door, Manual, Slimline	22	3	23 1/4 x 18 x 65	180	2790.00
SAQ057	893002	2 Doors, Manual	30	1	43 x 18 x 44	197	2571.00
SAQ058	893082	Sliding, Self-Closing	30	1	43 x 18 x 44	224	3933.00
SAQ059	893022	2 Doors, Self-Closing	30	1	43 x 18 x 44	201	2896.00
SAQ060	894502	2 Doors, Manual	45	2	43 x 18 x 65	268	3272.00
SAQ061	894582	Sliding Door, Self-Closing	45	2	43 x 18 x 65	305	5139.00
SAQ062	894522	2 doors, Self-Closing	45	2	43 x 18 x 65	273	3754.00

### ACCESSORIES

SAQ044	29939	Extra Shelf for 22-Gallon Undercounter Cabinets	-	-	31 11/20 x 18	7	227.00
SAP839	29937	Extra Shelf for 30 and 45-Gallon Cabinets	-	-	39 3/8 x 14	7	180.00

## CHEMCOR® LINED ACID/CORROSIVE STORAGE CABINETS

Unique, flame-coated ChemCor® thermoplastic liner is applied to Justrite's acid/corrosive safety cabinets for unsurpassed corrosion protection and fire protection.

- 100% seamless liner on all interior walls, ceiling, sump, inside doors and shelves protects exposed cabinet surfaces without gaps
- Seam-free surface eliminates the need for rivets or fasteners which risk corrosion from seep-through chemicals
- U-Loc™ handle comes with double key set or accepts optional padlock for greater security
- Haz-Alert™ reflective warning labels
- Durable, thermoplastic non-porous interior coating resists staining and cleans-up easily
- Maximum protection from harsh acids and corrosive chemicals plus fire protection and code compliance in a wide variety of double-wall steel safety cabinets
- FM approved



SAQ067



Seamless liner

Model No.	Mfg. No.	Door Type	Capacity Gallons	Adjustable Shelves	Ext. Dim. W" x D" x H"	Wt. lbs.	Price /Each
SAQ065	8923022	2 Doors, Manual, Undercounter	22	1	35 x 22 x 35	165	4112.00
SAQ066	8922022	1 Door, Manual, Slimline	22	3	23 1/4 x 18 x 65	190	4469.00
SAQ067	8930022	2 Doors, Manual	30	1	43 x 18 x 44	192	4112.00
SAQ068	8930822	Sliding, Self-Closing	30	1	43 x 18 x 44	238	5967.00
SAQ069	8930222	2 Doors, Self-Closing	30	1	43 x 18 x 44	200	4476.00
SAQ070	8945022	2 Doors, Manual	45	2	43 x 18 x 65	193	4973.00
SAQ071	8945822	Sliding, Self-Closing	45	2	43 x 18 x 65	312	7791.00
SAQ072	8945222	2 Doors, Self-Closing	45	2	43 x 18 x 65	274	5802.00

## POLYETHYLENE CORROSIVE/ACID CABINETS

- Store strong acids such as hydrochloric, sulfuric, or nitric acid; or bases such as sodium, potassium, or calcium hydroxide in this durable, high-density polyethylene (HDPE) cabinet
- With no metal parts to corrode, this cabinet offers chemical resistance against spills or potential damaging vapors when storing acids or bases
- A removable yet sturdy sump cover, which also serves as a bottom shelf, conceals the fully integrated, leakproof sump, 8.5 gal. capacity
- Recessed channels in shelf and base help direct spills to the back of the cabinet and down into the sump
- Three application-specific labels identify contents to safely store and segregate incompatible chemicals (ACID, BASE, and CORROSIVE)
- Doors open nearly 180 degrees for easy access, engage firmly with the body when closed, and accept a padlock (not included) for added security



SGB948  
Countertop



SDS951



Model No.	Mfg. No.	Capacity	No. of Shelves	No. of Doors	Door Type	Exterior Dimensions				Price /Each	
						W"	x	D"	x		H"
SGB948	24080	2 gal.	-	1	Manual	14 1/4	x	17 1/8	x	19 3/4	1234.00
SDS951	24180	24 gal. (Thirty-Six 2.5 L Bottles)	1	2	Manual	36	x	25	x	35	2772.00

## HAZARDOUS WASTE SAFETY CABINETS

- For temporary on-site accumulation and storage of waste liquids
- All-welded 18-gauge double wall construction with 1 1/2" air space
- 2" leakproof sill and 2" flame arrester vents
- One galvanised steel, half-depth shelf adjustable on 3" centres
- U-Loc™ handle comes with double key set or accepts optional padlock for greater security
- Rollers at bottom of cabinet facilitate drum movement (**Sold separately**)
- All models have 2 doors
- Haz-Alert™ reflective warning labels
- Meets OSHA and NFPA regulations
- FM approved



Model No.	Mfg. No.	Door Type	Drum Capacity	Ext. Dim. W" x D" x H"	Wt. lbs.	Price /Each
SAQ073	8962053	Manual	1-55 gallon	34 x 34 x 65	391	3754.00
SAQ074	8962253	Self-Closing	1-55 gallon	34 x 34 x 65	393	4290.00
SAQ075	8991053	Manual	2-55 gallon	59 x 34 x 65	610	6133.00

Model No.	Mfg. No.	Description	Dimension L" x W"	Wt. lbs.	Price /Each
SEE311	25920	Rollers for Single Cabinet	29 1/2 x 30	52	970.00
SEE312	25922	Rollers for Double Cabinet	55 1/2 x 30	99	1802.00

\*Codes state that not more than 60 gallons of Category I, II or III flammable liquids, nor more than 120 gallons of Category IV flammable liquids may be stored in a safety cabinet



SAQ075

## GAS CYLINDER CABINETS

- Heavy-duty construction
- 2" x 2" 10-gauge formed steel angle posts
- 9-gauge wire mesh doors and walls for venting
- 14-gauge checker plate shelves and roof
- English and French warning labels included
- Padlock hasp for added security
- Innovative door design allows for left or right opening installation
- Easy assemble, knock-down feature saves on shipping costs

**Note:** Constructed to meet or exceed strict CSA International B149.2-0 Propane Storage and Handling Code. Cylinders must be stored vertically at all times.



SAF848



SAF837



SEB837



SEB838



SAF847



## LIQUID PROPANE (35-LB CYLINDERS)

### COMPRESSED GAS (9" DIAMETER CYLINDERS)

Model No.	Dimensions				Cylinder Capacity	Wt. lbs.	Price /Each
	W"	x	D"	x			
SAF837	44	x	30	x	74	10	1379.00
SAF848*	88	x	30	x	74	20	2283.00

\*Consists of two units of the SAF837

Model No.	Dimensions				Cylinder Capacity	Wt. lbs.	Price /Each
	W"	x	D"	x			
SEB837*	30	x	17	x	37	2	639.00
SEB838*	17	x	17	x	69	2	769.00
SAF836	44	x	30	x	37	6	1155.00
SAF847	44	x	30	x	74	12	1436.00

\*All-welded, fully assembled

# SAFETY CONTAINERS

## D.O.T. ACCUFLOW™ SAFETY CANS

- Hold-down bracket with easy-to-grip tightening screw prevents vapour release and spills during transport
- Easy-to-engage fusible link bracket melts at 165°F (75°C) to prevent dangerous pressure build-up
- AccuFlow's™ exclusive Safe-Squeeze® trigger mechanism allows for smooth flow and accurate pouring
- Leak-tight, self-closing lid automatically vents between 3 and 5 PSIG
- Heavy roll bars protect the spout
- D.O.T. compliant and FM approved



**10 Year**  
Limited Warranty

SED121



SED119



Red Model No.	Mfg. No.	Yellow Model No.	Mfg. No.	Capacity Gal.	Hose Width"	Can Dim.			Price /Each
						Outer Dia."	x	H"	
SED117	7325120	SED121	7325220	2.5	5/8	11 3/4	x	13	622.00
SED118	7325130	SED122	7325230	2.5	1	11 3/4	x	13	622.00
SED119	7350110	SED123	7350210	5	5/8	11 3/4	x	18 1/2	633.00
SED120	7350130	SED124	7350230	5	1	11 3/4	x	18 1/2	633.00

## TYPE II ACCUFLOW™ SAFETY CANS

- AccuFlow™ exclusive Safe-Squeeze® trigger mechanism allows for smooth flow and accurate pouring
- Auto-venting pressure relief cap
- Leak-proof self-closing gasketed lid controls vapours and spills
- Long lasting stainless steel flame arrester dissipates heat and prevents flashback ignition
- Extra large ID zone reduces misuse and has warning in three languages
- FM approved, UL/ULC listed
- 10-year limited warranty

**10 Year**  
Limited Warranty



Red Model No.	Mfg. No.	Yellow Model No.	Mfg. No.	Blue Model No.	Mfg. No.	Green Model No.	Mfg. No.	Capacity US Gal.	Ext. Dim.			Price /Each
									Dia."	x	H"	
<b>5/8" HOSE WIDTH</b>												
SEA217	7210120	SEA218	7210220	SEA219	7210320	SEA220	7210420	1	9 1/2	x	10 1/2	219.00
SEA221	7220120	SEA222	7220220	SEA253	7220320	SEA223	7220420	2	9 1/2	x	13 1/4	217.00
SEA224	7225120	SEA226	7225220	SEA228	7225320	SEA230	7225420	2.5	11 3/4	x	12	223.00
SEA232	7250120	SEA234	7250220	SEA236	7250320	SEA238	7250420	5	11 3/4	x	17 1/2	227.00
<b>1" HOSE WIDTH</b>												
SEA225	7225130	SEA227	7225230	SEA229	7225330	SEA231	7225430	2.5	11 3/4	x	12	223.00
SEA233	7250130	SEA235	7250230	SEA237	7250330	SEA239	7250430	5	11 3/4	x	17 1/2	227.00

## TYPE I SAFETY CANS

- Compliant Type I Safety Cans are designed with a single spout for filling and pouring of all types of flammable liquids
- High performance, chemical resistant stainless steel flame arrester that stops flashback ignition, provides faster liquid flow, and offers exceptional durability and corrosion protection for long life
- Self-venting, self-closing leak tight lid prevents ruptures from pressure build-up and controls vapours and spills
- Unique counterbalance design with full-fisted grip handle offers gravity-assisted pouring
- Warning label includes large ID zone for user labelling to avoid misuse, reduce the potential for incompatible mixtures, or may be used to designate department or individual owner
- Optional poly funnel offers targeted pouring
- Finished in a tough powder coat paint, Justrite® cans resist chemicals and stand up to heavy abuse
- FM approved, UL/ULC listed
- 10-year limited warranty



SEA213



Red Model No.	Mfg. No.	Yellow Model No.	Mfg. No.	Blue Model No.	Mfg. No.	Green Model No.	Mfg. No.	Capacity	Ext. Dim.			Price /Each
									Dia."	x	H"	
<b>WITH FUNNEL</b>												
SEA240	7110110	SEA241	7110210	SEA242	7110310	SEA243	7110410	1 US Gal.	9 1/2	x	11	122.00
SEA204	7120110	SEA244	7120210	SEA245	7120310	SEA246	7120410	2 US Gal.	9 1/2	x	13 3/4	129.00
SEA208	7125110	SEA247	7125210	SEA248	7125310	SEA249	7125410	2.5 US Gal.	11 3/4	x	11 1/2	137.00
SEA213	7150110	SEA250	7150210	SEA251	7150310	SEA252	7150410	5 US Gal.	11 3/4	x	16 7/8	140.00
<b>WITHOUT FUNNEL</b>												
SAI516	10001	-	-	-	-	-	-	1 Pint	4 5/8	x	6 3/4	228.00
SAI517	10101	-	-	-	-	-	-	1 Quart	4 5/8	x	8 1/4	210.00
SEA199	7110100	SEA200	7110200	SEA201	7110300	SEA202	7110400	1 US Gal.	9 1/2	x	11	97.00
SEA203	7120100	SEA205	7120200	SEA206	7120300	SEA208	7120400	2 US Gal.	9 1/2	x	13 3/4	105.00
SEA207	7125100	SEA209	7125200	SEA210	7125300	SEA211	7125400	2.5 US Gal.	11 3/4	x	11 1/2	113.00
SEA212	7150100	SEA214	7150200	SEA215	7150300	SEA216	7150400	5 US Gal.	11 3/4	x	16 7/8	115.00

**10 Year**  
Limited Warranty





## LABORATORY SAFETY CANS IN STEEL & POLYETHYLENE

- Convenient dispensing in two styles for use on shelves or in tilt stands.
- Self-closing faucets offer controlled dispensing of hazardous liquids
- Fill spouts have self-closing pressure relief caps with built-in vacuum breakers and double mesh flame arresters
- The lab faucet allows easier dispensing into containers with small openings
- FM approved
- Capacity: 5 US Gal.



Model No.	Mfg. No.	Description	Faucet	Price /Each
SEC080	7150140	Steel shelf can	Control flow lab, 3/4" brass	429.00
SEC081	7150150	Steel plate shelf can	3/4" NPT rigid brass	326.00
SEC082	7150146	Steel plate tilt can w/stand	Control flow lab, 3/4" brass	546.00
SEC083	7150156	Steel plate tilt can w/stand	3/4" NPT rigid brass	551.00
SEC084	14545	Polyethylene shelf can	Control flow lab, 3/4" brass	518.00
SEC085	14535	Polyethylene tilt can w/stand	Control flow lab, 3/4" brass	691.00



## TYPE I POLYETHYLENE SAFETY CANS

- Choose type I nonmetallic safety cans when dent and chemical resistance are important. Type I safety cans constructed of high-density polyethylene offer distinct advantages over steel units.
- Dent, chip and puncture-resistant polyethylene stands up to harsh corrosives
- Current carrying carbon insert grounds the opening and flame arrester
- Self-close spout and pressure relief mechanism
- Flame arrester prevents ignition sources from entering the can
- Stainless steel hardware provides chemical protection
- FM approved



FM APPROVED - OVAL

Model No.	Mfg. No.	Capacity US Gal.	Dimensions				Price /Each	
			L"	x	W"	x		H"
SC291	14160	1	7 5/8	x	4 5/8	x	12 3/4	175.00

FM, UL, ULC APPROVED - ROUND

Model No.	Mfg. No.	Capacity US Gal.	Dimensions			Price /Each
			Outer Dia."	x	H"	
SC293	14261	2 1/2	10 3/4	x	14 1/4	273.00
SC295	14561	5	12 3/4	x	16	346.00



## POLYETHYLENE LIQUID DISPOSAL CANS

- High-density polyethylene cans contain corrosives and flammable liquids better than conventional metal cans
- Large opening for better control when disposing of liquids
- Fixed position handle allows lid to stay open for easier pouring
- Flame arrester guards against outside sources
- When closed, the cap automatically vents between 3 and 5 PSIG
- Stainless steel hardware provides chemical protection
- FM approved

SC306



Model No.	Mfg. No.	Capacity US Gal.	Dimensions			Price /Each
			Outer Dia."	x	H"	
SC306	14762	2	12	x	14 3/4	409.00
SC308	14765	5	12	x	20	448.00

## QUICK-DISCONNECT SAFETY DISPOSAL CANS

- Collect waste liquid easily and safely with FM approved quick-disconnect safety disposal cans
- Ideal for HPLC applications
- Safeguard against spills and accidents associated with common collection practices
- Stainless steel fittings with Teflon® O-rings for chemical resistance or economically priced polypropylene fittings
- FM approved



Solvents flow freely into can through 3/8" tubing and can is easily disconnected with a special valved fitting without vapour release or solvent leakage.



Model No.	Mfg. No.	Fitting Material	Capacity US Gal.	Dimensions			Material	Price /Each
				Outer Dia."	x	H"		
SAI569	PP12752	Polypropylene	2	12	x	14 3/4	EPDM	738.00
SAI570	TF12752	Stainless Steel	2	12	x	14 3/4	Teflon®	1433.00
SAI571	PP12755	Polypropylene	5	12	x	20	EPDM	795.00
SAI572	TF12755	Stainless Steel	5	12	x	20	Teflon®	1489.00

# SAFETY CONTAINERS

## OILY WASTE CANS

- OSHA compliant oily waste cans are essential whenever solvent cloths and wiping rags are used
- Self-closing cover reduces oxygen source to prevent fire from starting
- Round construction and raised bottom encourage air circulation to disperse heat and prevent rust
- Rugged galvanized steel body in a variety of sizes accommodate any work area
- Carrying handle for portability
- 2 US gallon hand-operated, countertop model is FM approved
- 6 - 21 US Gal. foot-operated models are FM approved and UL listed



SR357



SoundGard™ Silver Model No.	Mfg. No.	Yellow Model No.	Mfg. No.	Red Model No.	Mfg. No.	Capacity US Gal.	Dimensions			Wt. lbs.	Price /Each
							Outer Dia.™	x	H™		
-	-	SR361	09200Y	SR356	09200	2	9 5/8	x	9 1/8	6	167.00
SAR304	09104	SR362	09101	SR357	09100	6	11 7/8	x	15 7/8	10	218.00
SAR305	09304	SR363	09301	SR358	09300	10	13 15/16	x	18 1/4	13	250.00
SAR306	09504	SR364	09501	SR359	09500	14	16 1/16	x	20 1/4	16	289.00
SAR307	09704	SR365	09701	SR360	09700	21	18 3/8	x	23 7/16	22	407.00

## MINI BENCH-TOP OILY WASTE CANS

- Small footprint is convenient in confined work areas
- Constructed of durable galvanized steel
- Easily accommodates counter top applications
- Specially designed SoundGard™ lid significantly reduces lid closure noise
- Fire resistant design makes it ideal for disposing of hazardous waste materials like swabs or wipes that contain flammable solvents, adhesives, or cleaning agents
- Compact height easily accepts standard long cotton-tip applicators used for cleaning parts
- Lid opens to a maximum 60° and is self closing to minimize the chance of fire caused by spontaneous combustion
- Chemically resistant red powder coat paint finish for extended service life
- Leak-proof 0.45 Gal. (1.7-L) capacity container
- Reusable, will not rust or puncture
- Fire tested and FM and OSHA approved



Model No.	Mfg. No.	Dia.*	Dimensions x H	Wt. lbs.	Price /Each
SAS238	09410	4 5/8" base	x 6 1/2"	6	205.00

\* 6 1/2" (165 mm) diameter across the top including the limit stop

## DRIP CANS

- Ideal for placement below drum faucets, drains or valves to catch drips or overflows of liquids
- Perforated metal fire bafflects as a flame arrester to protect contents from fire exposure
- Catches up to one US gallon of liquid
- Top removes for quick cleaning
- Made of 24-gauge steel with a durable powder coat paint finish
- Easily portable with handy side handles
- 9 3/8" O.D. x 4 1/2" H
- Weight: 4 lbs.
- FM approved

Model No. SAH514  
Mfg. No. 10376  
Price/Each \$150.00



## PLUNGER CANS

- Dispense flammable liquids and solvents safely onto cloths or swabs without waste or exposure
- Plunger fills upper pan for soaking
- Surplus liquid drains safely back into can
- Brass pump parts resist corrosion
- Steel and polyethylene cans available
- FM approved

SC309



SC310

## FUSIBLE LINK SELF-CLOSING DRUM COVERS

- Convert open top 55 US gallon steel drums into fire-safe receptacles for combustible trash
- Replaceable fusible link assembly inside the cover melts at 165°F, automatically slamming the cover shut if a fire occurs in the drum
- Steel construction
- Solvent resistant, red baked-on enamel finish
- Fits drums from 22 1/2" to 22 3/4" in diameter
- Weight: 10 lbs.
- FM approved

Model No. DA097  
Mfg. No. 26750  
Price/Each \$376.00



Model No.	Mfg. No.	Capacity	Dimensions			Price /Each
			Outer Dia.™	x	H™	
<b>STEEL PLUNGER CANS</b>						
SA129	10008	1 pint	4 7/8	x	5 1/4	122.00
SA130	10108	1 quart	7 1/4	x	7 5/8	131.00
SC309	10308	1 US gallon	7 1/4	x	10 1/2	148.00
<b>POLYETHYLENE PLUNGER CANS</b>						
SC310	14018	1 quart	5 1/2	x	8 1/4	183.00

## DISPENSER BOTTLES

- Dispense flammable liquids and solvents safely without waste or exposure.
- Small size allows for easy, one-handed dispensing of liquids directly onto work surface
- Brass dispenser valves are leak-proof and self-closing
- Minimizes spills and waste
- Bottle design is textured for firm gripping
- FM approved for flammables



Model No.	Mfg. No.	Capacity	Dimensions			Approval Listing	Price /Each
			Outer Dia.,"	x	H"		
SC311	14002	4 oz.	2 1/4	x	5 1/2	FM	126.00
SA131	14004	8 oz.	3 1/8	x	5 1/2	FM	90.80
SA133	14010	1 quart	4	x	10 1/2	FM	106.00

## DISPENSING SQUEEZE BOTTLES

- Allow safe dispensing of liquid small components or sub-assemblies with a minimum of over-spray. Squeezing the bottle produces a fine stream of liquid.
- Low-density polyethylene with stainless steel wire that allows stem to be shaped to reach hard-to-reach areas



Model No.	Mfg. No.	Capacity oz.	Dimensions			Price /Each
			Outer Dia.,"	x	H"	
SA132	14009	16	3	x	7 1/2	60.60
SA134	14011	32	3 1/2	x	9 1/8	62.20

## ECO® GAS CANS

- The safest, most environmentally-friendly cans available
- Uses patented DuPont® Laminar Technology resulting in a permeation level well below the CARB required rate of 0.40 grams/gallon/day
- Equipped with self-venting spout that automatically shuts off when gas tank is full
- Rustproof, unbreakable and non-corroding
- ULC and CSA approved



Model No.	Mfg. No.	Colour	Capacity US Gal.	Capacity Litres	Price /Each
SA0955	07378	Red	2 1/2	10	35.90

SA0955



## JERRY CANS

- Made from high-density polyethylene
- Lightweight, crushproof design with extra headspace built-in to accommodate expansion
- User-friendly "easy pour" design, self-venting spouts and child-resistant closures
- Cans are rustproof, unbreakable and non-corroding
- 5 US gallon available in two colours; red for gasoline and yellow for diesel
- SAK857 is a combo can, gasoline and oil
- ULC and CSA approved



Model No.	Mfg. No.	Colour	Application	Capacity US Gal.	Capacity Litres	Price /Each
SAP356	07081	Red	Gasoline	1.25	5	14.60
SAP357	07079	Red	Gasoline	2.5	10	18.50
SA0958	07622	Red	Gasoline	5.3	20.06	29.90
SAK856*	03609	Red	Gasoline	5.3	20.06	36.80
SAK857	03615	Red	Gasoline/oil	1.58 and 0.59	6 and 2.5	40.90
SAP399	07649	Yellow	Diesel	5.3	20.06	29.90

\* Unique profile carries a smaller footprint making it easy to store in smaller spaces

### REPLACEMENT PARTS

Model No.	Mfg. No.	Description	Price/Each
SAS112	03647	Black cap, yellow stopper, spout and vent cap	14.10

SAK856

SAP399



SAK857

SA0958

SAP356

SAP357





# ASHTRAYS

## HEAVY-DUTY BUTT CANS

- Rugged heavy-duty fire safe galvanized steel base and neck tube finished in a tough powder-coated red paint
- Polyethylene topper with molded-in graphics for cigarette butt disposal
- Self-extinguishing design offers maximum convenience and reduces the risk of fire



Model No.	Dimensions			Capacity US Gallons	Wt. Lbs.	Price /Each
	Dia."	x	H"			
JB906	11 1/2	x	34	2.5	9.6	175.00
JB907	11 1/2	x	38 1/2	5	10.5	195.00

## ELITE™ SMOKERS CEASE FIRE®

- Polyethylene receptacle that will not rust and features a patented oxygen-restricting, self-extinguishing design to safely collect burning butts
- Stainless steel perforated snuffer and restricted entry design reduces unwanted trash
- Quick and easy assembly with snap-lock closures – no tools required, easy maintenance
- Packaged in a small 18" cube carton, sized to average a 34% cost savings on shipping, and reduces inventory space
- Liner and smoke receptacle are FM approved
- 12" Dia. x 38" H
- Capacity: 4 US gal/15 L
- Weight: 11 lbs/5 kg

JC064



Model No.	Colour	Price /Each
JC064	Cool Grey	330.00
JC065	Sierra Tan	335.00
JC066	Deco Black	320.00

Model No.	Description	Price /Each
JC069	Padlock	56.90
JC070	Replacement Pail	93.50

## SMOKERS CEASE-FIRE®

- Flame-retardant, high-density polyethylene construction
- Low maintenance will not rust, dent, crack or peel
- Innovative design limits the flow of oxygen to safely and quickly extinguish cigarettes and reduce the risk of fire
- Molded-in graphics clearly identify unit for cigarette butt disposal
- Complete with large 16 qt. (15 L) capacity galvanised steel liner pail for easy cleaning excluding Personal Smokers Cease-Fire®
- FM approved



Product Description	Dimensions			Capacity US Gal.	Wt. lbs.	Pewter Grey	Adobe Beige	Deco Black	Terra Cotta	Forest Green	Price /Each
	Dia."	x	H"			Model No.	Model No.	Model No.	Model No.	Model No.	
Original Smokers Cease-Fire®	16 1/2	x	38 1/2	4	11	NH832	NI378	NI694	NI587	NI695	199.00
Personal Smokers Cease-Fire®	11	x	30	1	6	NI701	NI702	NI703	NI705	NI704	179.00

## CEASE-FIRE® WASTE CANS

- Specially designed contoured head directs smoke and gas from any fire inside the container back into the combustion area
- Air supply is limited and flames are extinguished in seconds
- Drum bodies made of heavy gauge steel with a grey enamel exterior and a rust preventive interior coating
- FM approved, corrosion-free aluminum heads provide easy clean-up and can be used with standard steel drums
- Aluminum heads can be easily replaced and are available separately



Model No.	Capacity US Gal.	Dimensions Dia." x H"		Opening Dia."	Wt. lbs.	Price /Each
NC444	4.5	12 1/8	x 14 1/4	5	6	245.00
NC445	6	12 1/8	x 16 3/4	5	6	249.00
NC446	12	14 1/2	x 21 3/4	5 1/4	10	287.00
NC447	15	14 1/2	x 25 3/4	5 1/4	12	299.00
NC448	30	19 1/4	x 29 3/4	7	28	469.00
NC449	55	23 3/4	x 35 1/2	7 7/8	35	759.00

### ALUMINUM HEAD

Model No.	Description	Price/Each
NI416	Aluminum Head for 4.5 to 6-Gallon Receptacles	85.50
NI417	Aluminum Head for 12 to 15-Gallon Receptacles	119.00
NI418	Aluminum Head for 30-Gallon Receptacles	149.00
NI419	Aluminum Head for 55-Gallon Receptacles	175.00



## FINE FIBRE SORBENT PADS & ROLLS – INDUSTRIAL GRADE

- Premium industrial grade fine fibre
- Bonded tri layered construction offers a smooth lint free finish that does not leave fibre residue behind
- Quickest absorption rate and increased durability
- Offers maximum absorbency and strength
- Adheres well to floors to offer a secure footing
- All universal and hazmat pads and rolls are static resistant and made of up to 90% recycled materials
- All sorbent pads and rolls have absorption capacities of more than 25x their weight
- Rolls are perforated along the middle & cross direction every 18"

Heaviest grade of fine fibre finish in the industry

### OIL ONLY

Priced per Package

Model No.	Weight	Dimensions L x W	Absorbency/Pkg. Gallons	Qty /Pkg.	Price /Each
<b>PADS – OIL ONLY</b>					
SEI956	Heavy	15" x 17"	40	100	158.00
SEI957	Medium	15" x 17"	35	100	139.00
SEI958	Light	15" x 17"	40	200	150.00
<b>ROLLS – OIL ONLY</b>					
SEI959	Heavy	150' x 30"	70	1	315.00
SEI960	Heavy	150' x 15"	35	1	150.00
SEI961	Medium	150' x 30"	50	1	246.00
SEI962	Medium	150' x 15"	25	1	129.00

SEI956



SEI959

### UNIVERSAL

Priced per Package

Model No.	Weight	Dimensions L x W	Absorbency/Pkg. Gallons	Qty /Pkg.	Price /Each
<b>PADS – UNIVERSAL</b>					
SEI963	Heavy	15" x 17"	40	100	170.00
SEI964	Medium	15" x 17"	35	100	152.00
SEI965	Light	15" x 17"	40	200	170.00
<b>ROLLS – UNIVERSAL</b>					
SEI966	Heavy	150' x 30"	70	1	329.00
SEI967	Heavy	150' x 15"	35	1	175.00
SEI968	Medium	150' x 30"	50	1	299.00
SEI969	Medium	150' x 15"	25	1	152.00

SEI963



SEI966

### HAZMAT

Priced per Package

Model No.	Weight	Dimensions L x W	Absorbency/Pkg. Gallons	Qty /Pkg.	Price /Each
<b>PADS – HAZMAT</b>					
SEI970	Heavy	15" x 17"	40	100	177.00
SEI971	Medium	15" x 17"	35	100	155.00
SEI972	Light	15" x 17"	40	200	177.00
<b>ROLLS – HAZMAT</b>					
SEI973	Heavy	150' x 30"	70	1	335.00
SEI974	Heavy	150' x 15"	35	1	178.00
SEI975	Medium	150' x 30"	50	1	293.00
SEI976	Medium	150' x 15"	25	1	150.00

SEI963

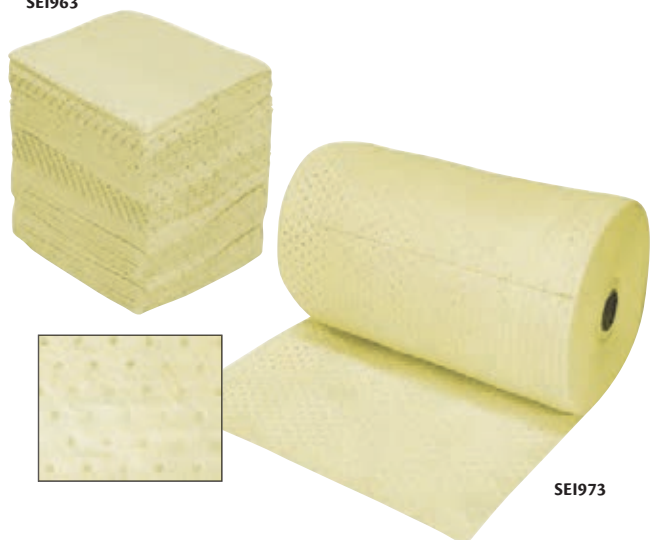

SEI973

## FINE FIBRE SORBENT PADS & ROLLS

- Premium fine fibre
- Bonded tri layered construction offers a smooth lint free finish that does not leave fibre residue behind
- Quickest absorption rate and increased durability
- Offers superior absorbency and strength
- Adheres well to floors to offer a secure footing
- All universal and hazmat pads and rolls are antistatic and made of up to 90% recycled materials
- All sorbent pads and rolls have absorption capacities of more than 25x their weight
- Rolls are perforated along the middle & cross direction every 18"



### OIL ONLY

Priced per Package

Model No.	Weight	Dimensions L x W	Absorbency/Pkg. Gallons	Qty /Pkg.	Price /Each
<b>PADS – OIL ONLY</b>					
SEH974	Heavy	15" x 17"	30	100	125.00
SEH975	Medium	15" x 17"	25	100	119.00
SEI977	Light	15" x 17"	30	200	130.00
<b>ROLLS – OIL ONLY</b>					
SEH976	Heavy	150' x 30"	50	1	256.00
SEH977	Heavy	150' x 15"	25	1	140.00
SEH978	Medium	150' x 30"	40	1	218.00
SEH979	Medium	150' x 15"	20	1	117.00



### UNIVERSAL

Priced per Package

Model No.	Weight	Dimensions L x W	Absorbency/Pkg. Gallons	Qty /Pkg.	Price /Each
<b>PADS – UNIVERSAL</b>					
SEJ936	Heavy	15" x 17"	30	100	133.00
SEH981	Medium	15" x 17"	25	100	118.00
SEI978	Light	15" x 17"	30	200	140.00
<b>ROLLS – UNIVERSAL</b>					
SEH982	Heavy	150' x 30"	50	1	267.00
SEH983	Heavy	150' x 15"	25	1	145.00
SEH984	Medium	150' x 30"	40	1	233.00
SEH985	Medium	150' x 15"	20	1	122.00

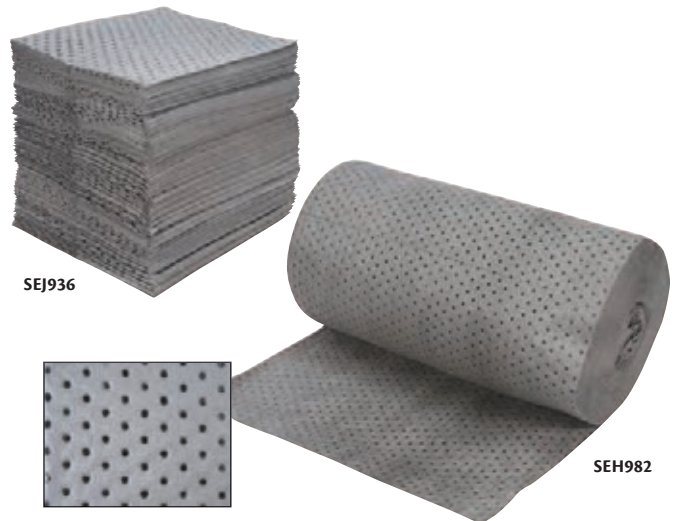

### HAZMAT

Priced per Package

Model No.	Weight	Dimensions L x W	Absorbency/Pkg. Gallons	Qty /Pkg.	Price /Each
<b>PADS – HAZMAT</b>					
SEH986	Heavy	15" x 17"	30	100	133.00
SEI979	Medium	15" x 17"	25	100	119.00
SEH987	Light	15" x 17"	30	200	140.00
<b>ROLLS – HAZMAT</b>					
SEH988	Heavy	150' x 30"	50	1	275.00
SEI980	Heavy	150' x 15"	25	1	140.00
SEI981	Medium	150' x 30"	40	1	260.00
SEI982	Medium	150' x 15"	20	1	140.00

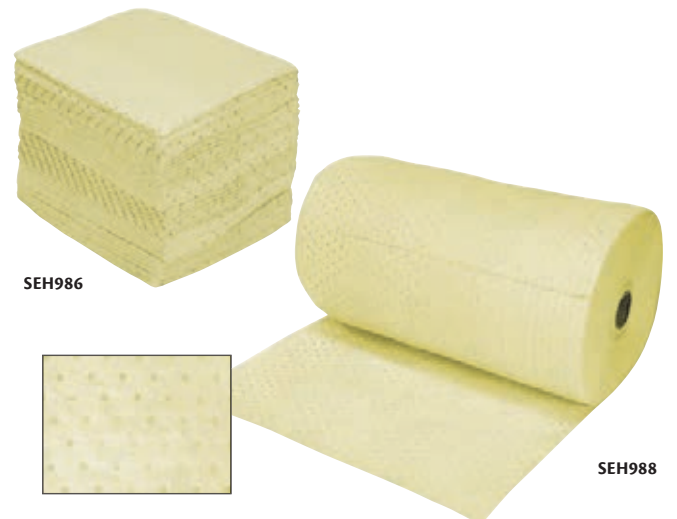



## LAMINATED (SMS) SORBENT PADS & ROLLS

- Three layer spun bonded/melt blown/spun bonded finish (SMS)
- Extra strength polypropylene outer layer
- Laminated sorbents are lint free and permit a fast and easy clean up
- Premium durability; ideal for high traffic surfaces
- All universal and hazmat pads and rolls are antistatic and made of up to 90% recycled materials
- All sorbent pads and rolls have absorption capacities of more than 25x their weight
- Rolls are perforated along the middle & cross direction every 18"

### OIL ONLY

Priced per Package

Model No.	Weight	Dimensions L x W	Absorbency/Pkg. Gallons	Qty /Pkg.	Price /Each
<b>PADS – OIL ONLY</b>					
SEH990	Heavy	15" x 17"	30	100	117.00
SEI983	Medium	15" x 17"	25	100	97.50
SEI984	Light	15" x 18"	30	200	139.00
<b>ROLLS – OIL ONLY</b>					
SEH991	Heavy	150' x 30"	50	1	240.00
SEH992	Heavy	150' x 15"	25	1	125.00
SEI986	Medium	150' x 30"	40	1	229.00
SEI987	Medium	150' x 15"	20	1	122.00

SEH990



SEH991

### UNIVERSAL

Priced per Package

Model No.	Weight	Dimensions L x W	Absorbency/Pkg. Gallons	Qty /Pkg.	Price /Each
<b>PADS – UNIVERSAL</b>					
SEH996	Heavy	15" x 17"	30	100	118.00
SEI988	Medium	15" x 17"	25	100	110.00
SEI989	Light	15" x 17"	30	200	140.00
<b>ROLLS – UNIVERSAL</b>					
SEH994	Heavy	150' x 30"	50	1	245.00
SEH995	Heavy	150' x 15"	25	1	145.00
SEI990	Medium	150' x 30"	40	1	229.00
SEI991	Medium	150' x 15"	20	1	122.00

SEH996

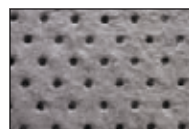

SEH994

### HAZMAT

Priced per Package

Model No.	Weight	Dimensions L x W	Absorbency/Pkg. Gallons	Qty /Pkg.	Price /Each
<b>PADS – HAZMAT</b>					
SEI992	Heavy	15" x 17"	30	100	135.00
SEI993	Medium	15" x 17"	25	100	123.00
SEI994	Light	15" x 17"	30	200	140.00

SEI992



# SPILL CONTROL MANAGEMENT SUPPLIES

## BONDED SORBENT PADS & ROLLS

- 100% bonded polypropylene fibre
- Ideal for applications that require increased tensile strength
- More durable than traditional meltblown sorbents
- Bonded pads offer low linting and permit an easy clean up
- All universal and hazmat pads and rolls are static resistant and made of up to 90% recycled materials
- All sorbent pads and rolls have absorption capacities of more than 25x their weight
- Rolls are perforated along the middle & cross direction every 18"



### OIL ONLY

Priced per Package

Model No.	Weight	Dimensions L x W	Absorbency/Pkg. Gallons	Qty /Pkg.	Price /Each
<b>PADS – OIL ONLY</b>					
SEJ934	Heavy	15" x 18"	30	100	88.50
SEH968	Heavy	15" x 17"	8	25	31.50
SEH969	Medium	15" x 17"	25	100	61.50
SEI999	Light	15" x 17"	15	100	58.25
SEH970	Light	15" x 17"	30	200	93.00
<b>ROLLS – OIL ONLY</b>					
SEH972	Heavy	150' x 30"	50	1	236.00
SEH971	Heavy	150' x 15"	25	1	128.00
SEJ001	Medium	150' x 30"	40	1	195.00
SEJ002	Medium	150' x 15"	20	1	118.00
SEH973	Light	300' x 30"	55	1	218.00

SEJ934



SEH972

### UNIVERSAL

Priced per Package

Model No.	Weight	Dimensions L x W	Absorbency/Pkg. Gallons	Qty /Pkg.	Price /Each
<b>PADS – UNIVERSAL</b>					
SEJ935	Heavy	15" x 17"	30	100	95.00
SEH959	Heavy	15" x 17"	8	25	38.95
SFU959*	Heavy	15" x 17"	30	100	96.00
SEJ940	Medium	15" x 18"	25	100	84.50
SEH961	Light	15" x 17"	15	100	63.00
SEH962	Light	15" x 17"	30	200	126.00
<b>ROLLS – UNIVERSAL</b>					
SEH966	Heavy	150' x 30"	50	1	220.00
SEH965	Heavy	150' x 15"	25	1	129.00
SEH964	Medium	150' x 30"	40	1	196.00
SEH963	Medium	150' x 15"	20	1	108.00

\* Comes in a box

SEH959

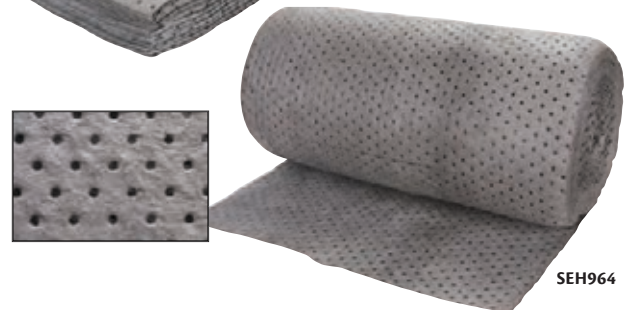

SEH964

### HAZMAT

Priced per Package

Model No.	Weight	Dimensions L x W	Absorbency/Pkg. Gallons	Qty /Pkg.	Colour	Price /Each
<b>PADS – HAZMAT</b>						
SEI007	Heavy	15" x 18"	30	100	Yellow	120.00
SGC512	Heavy	15" x 18"	30	100	Green	120.00
SEJ004	Medium	15" x 17"	25	100	Yellow	104.00
SGC515	Medium	15" x 18"	25	100	Green	88.50
SEJ005	Light	15" x 17"	15	100	Yellow	69.50
SEJ006	Light	15" x 18"	30	200	Yellow	132.00
SGC514	Light	15" x 18"	30	200	Green	132.00
<b>ROLLS – HAZMAT</b>						
SEI009	Heavy	150' x 30"	50	1	Yellow	255.00
SGC513	Heavy	150' x 30"	50	1	Green	232.00
SEI008	Heavy	150' x 15"	25	1	Yellow	140.00
SEJ008	Medium	150' x 30"	40	1	Yellow	240.00
SEJ009	Medium	150' x 15"	20	1	Yellow	129.00

SEI007



SGC512

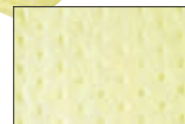

## BLUE BONDED SORBENT PADS & ROLLS

- 100% bonded polypropylene fibre
- Ideal for applications that require increased tensile strength
- More durable than traditional meltblown sorbents
- Bonded pads offer low linting and permit an easy clean up
- All sorbent pads and rolls have absorption capacities of more than 25x their weight
- Blue pads and rolls are excellent for snow conditions, where distinguishing colour is needed
- Same quality and finish as the white pads and rolls
- Rolls are perforated along the middle & cross direction every 18"

Also available in fine fibre and laminated



Priced per Package

Model No.	Weight	Dimensions L x W	Absorbency/Pkg. Gallons	Qty /Pkg.	Price /Each
<b>BLUE PADS – OIL ONLY</b>					
SEJ186	Heavy	15" x 18"	30	100	88.50
SEJ187	Heavy	15" x 17"	8	25	31.50
SEJ188	Medium	15" x 17"	25	100	69.50
SEJ189	Light	15" x 17"	15	100	55.95
SEJ190	Light	15" x 17"	30	200	96.25
<b>BLUE ROLLS – OIL ONLY</b>					
SEJ191	Heavy	150' x 30"	50	1	225.00
SEJ192	Heavy	150' x 15"	25	1	129.00
SEJ193	Medium	150' x 30"	40	1	204.00
SEJ194	Medium	150' x 15"	20	1	112.00
SEJ195	Light	300' x 30"	55	1	218.00

SEJ186

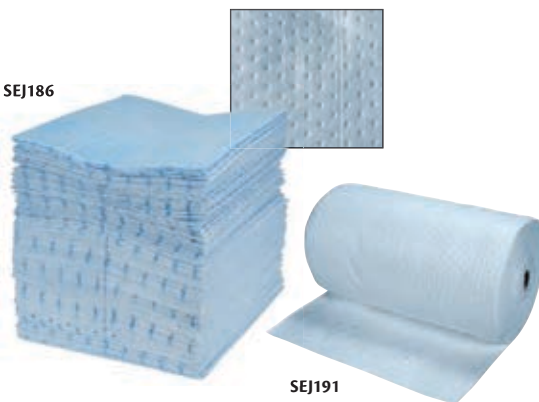

SEJ191

## CAUTION - HIGH VISIBILITY ABSORBENTS

- High visibility yellow with the international symbol for slip hazard helps reduce slips, trips and falls
- Spunbond side is abrasion-resistant, great for foot traffic and fine fibre side grips to smooth surfaces
- Quick and effective solution to absorb non-hazardous types of liquids
- Perforated to help reduce waste

SGC496

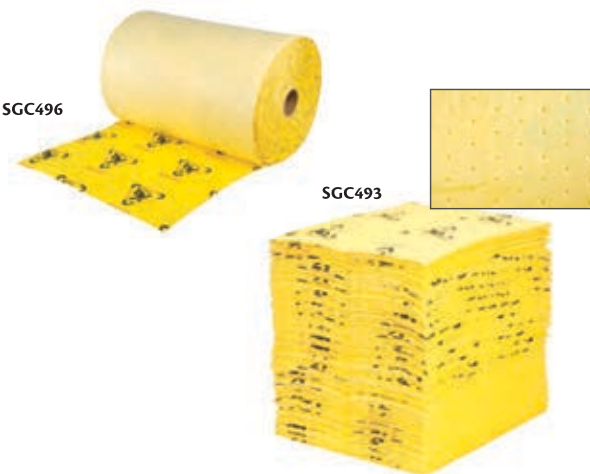

SGC493



Priced per Package

Model No.	Weight	Dimensions L x W	Absorbency/Pkg. Gallons	Qty /Pkg.	Price /Each
<b>PADS - UNIVERSAL</b>					
SGC493	Heavy	15" x 18"	24.4	100	236.00
<b>ROLLS - UNIVERSAL</b>					
SGC495	Heavy	150' x 36"	57	1	524.00
SGC494	Heavy	150' x 30"	57	1	295.00
SGC496	Heavy	150' x 24"	37.6	1	358.00

## CAMOUFLAGE UNIVERSAL SORBENTS

- Three layer spun bonded/melt blow/spun bonded finish (SMS)
- Strong tensile strength is ideal for wiping and MRO applications
- Military camouflage design and colour offers maximum spill and dirt concealment
- All universal and hazmat pads and rolls are static resistant and made of up to 90% recycled materials
- All sorbent pads and rolls have absorption capacities of more than 25x their weight

SEI057

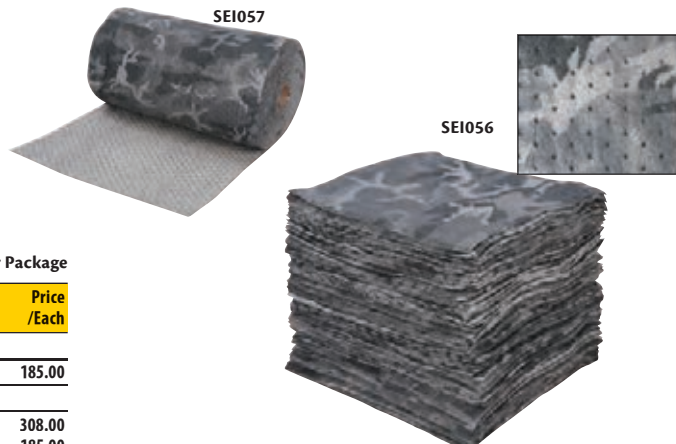

SEI056



Priced per Package

Model No.	Weight	Dimensions L x W	Absorbency/Pkg. Gallons	Qty /Pkg.	Price /Each
<b>PADS - UNIVERSAL</b>					
SEI056	Heavy	15" x 17"	25	100	185.00
<b>ROLLS - UNIVERSAL</b>					
SEI057	Heavy	150' x 30"	50	1	308.00
SEI058	Heavy	150' x 15"	25	1	185.00



# SPILL CONTROL MANAGEMENT SUPPLIES

## MELTBLOWN SORBENT PADS & ROLLS

- 100% meltblown polypropylene fibre
- Most cost effective sorbent in the industry
- Permit an easy and quick clean up
- Quick and effective solution for oil spills or leaks
- All sorbent pads and rolls have absorption capacities of more than 25x their weight



Priced per Package

Model No.	Weight	Dimensions			Absorbency/Pkg. Gallons	Qty /Pkg.	Price /Each
L	x	W					
<b>PADS - OIL ONLY</b>							
SEH942	Heavy	15"	x	17"	30	100	77.00
SEH943	Heavy	15"	x	17"	8	25	28.50
SEH944	Medium	15"	x	17"	25	100	70.50
SEH946	Medium	30"	x	30"	50	50	252.00
SEH945	Light	15"	x	18"	15	100	56.95
SEI620	Light	15"	x	17"	30	200	85.75
<b>ROLLS - OIL ONLY</b>							
SEH947	Heavy	150'	x	30"	50	1	232.00
SEH948	Heavy	150'	x	15"	25	1	126.00
SEH949	Medium	150'	x	30"	40	1	200.00
SEH950	Medium	150'	x	15"	20	1	110.00



SEH942



SEH947



## MELTBLOWN SORBENT PADS - UNIVERSAL

- 100% meltblown polypropylene fibre
- Permits an easy and quick clean up
- Quick and effective solution to absorb non-hazardous types of liquids
- These sorbents have absorption capacities of more than 25x their weight
- Spill Type: Universal



Priced per Package

Model No.	Weight	Dimensions			Absorbency/Pkg. Gallons	Qty /Pkg.	Price /Each
L	x	W					
SGC489	Heavy	15"	x	18"	30	100	92.95
SGC490	Medium	15"	x	18"	25	100	74.95
SGC491	Light	15"	x	18"	30	200	122.00



SGC489

## ANTI STATIC SORBENT PADS

- 100% meltblown polypropylene fibre
- Chemically treated with anti static agent
- Permit an easy and quick clean up
- Ideal for cold conditions or highly flammable environments, will not spark
- All sorbent pads have absorption capacities of more than 25x their weight



Priced per Package

Model No.	Weight	Dimensions			Absorbency/Pkg. Gallons	Qty /Pkg.	Price /Each
L"	x	W"					
<b>PADS - OIL ONLY</b>							
SEI577	Heavy	15	x	18	25	100	170.00
SEJ014	Heavy	30	x	30	55	50	342.00



SEI577

## HIGH TRAFFIC UNIVERSAL SORBENTS

- Three layer spun bonded/melt blow/fine fibre finish (SMF)
- Best suited for problem areas with high traffic
- Conceived for added durability and absorbency
- Offers the top layer strength of laminated sorbents, with the bottom layer floor adherence of fine fibre sorbents
- Ideal for use in forklift traffic areas
- All universal rolls are static resistant and made of up to 90% recycled materials
- All sorbent rolls have absorption capacities of more than 25x their weight

Also available in laminated, bonded and meltblown



Model No.	Weight	Dimensions			Absorbency/Pkg. Gallons	Qty /Pkg.	Price /Each
		L	x	W			
<b>ROLLS - UNIVERSAL</b>							
SEJ015	Heavy	150'	x	30"	60	1	330.00
SEJ016	Heavy	150'	x	15"	30	1	180.00
SEJ017	Light	150'	x	30"	40	1	290.00
SEJ018	Light	150'	x	15"	20	1	162.00

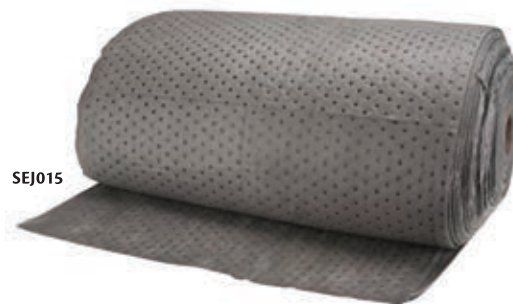

SEJ015

## RAG RUGS

- Made of 100% recycled cotton and polyester, with a binder on one side
- Provides an excellent non-slip surface for work spaces
- Best suited for busy areas with leaks and drips
- Protects floor by preventing damage, and keeps it dry and clean
- Absorbs more than 12 times its weight in oil, water, or chemicals



Model No.	Weight	Dimensions			Absorbency/Pkg. Gallons	Qty /Pkg.	Price /Each
		L	x	W			
<b>ROLLS - UNIVERSAL</b>							
SEI055	Heavy	150'	x	36"	61	1	245.00

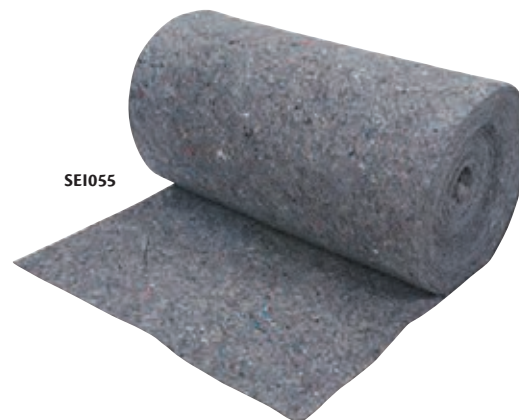

SEI055

## INDUSTRIAL RUGS

- Needle punched 100% polypropylene fibre
- Provides an excellent non-slip surface for work spaces
- Best suited for busy areas with leaks and drips
- Protects floor by preventing damage, while keeping it dry and clean
- Absorbs more than 12 times its weight in oil, water, or chemicals



Model No.	Weight	Dimensions			Absorbency/Pkg. Gallons	Qty /Pkg.	Price /Each
		L	x	W			
<b>ROLLS - UNIVERSAL</b>							
SEJ019	Heavy	100'	x	36"	25	1	240.00
SEJ020	Heavy	150'	x	36"	35	1	319.00
SEJ021	Heavy	300'	x	36"	70	1	579.00



SEJ019

# SPILL CONTROL MANAGEMENT SUPPLIES

## POLY BACKED INDUSTRIAL RUGS

- Needle punched 100% polypropylene fibre
- Poly backing prevents absorbed fluids from penetrating through to the floor
- Provides an excellent non-slip surface for work spaces
- Best suited for busy areas with leaks and drips
- Protects floor by preventing damage, while keeping it dry and clean
- Absorbs more than 12 times its weight in oil, water, or chemicals



Model No.	Weight	Dimensions L x W	Absorbency/Pkg. Gallons	Qty /Pkg.	Price /Each
<b>ROLLS - UNIVERSAL</b>					
SEJ022	Heavy	50' x 36"	25	1	222.00
SEJ023	Heavy	100' x 36"	35	1	375.00
SEJ024	Heavy	150' x 36"	70	1	554.00

## ADHESIVE SORBENT MAT

- Adhesive backing ensures that the mat won't shift from foot or forklift traffic
- Easy to cut and apply to all types of work surfaces
- Fast-drying and easy to clean
- Great absorbency and highly durable
- Weight: Medium



Model No.	Dimensions L x W	Absorbency/Pkg. Gallons	Qty /Pkg.	Price /Each
<b>MAT - UNIVERSAL</b>				
SGE697	50' x 18"	6.25	1	229.00
SGE695	50' x 36"	12.5	1	435.00
SGE698	100' x 18"	12.5	1	419.00
SGE696	100' x 36"	25	1	730.00

## OIL ONLY SWEEP

- Made of durable laminated polypropylene
- 2" nylon webbing for additional strength is added on the length of the sweep
- Ideal for marine spill, fine sheen and surface spill removal
- Sorbent sweep absorbs oil, and repels water
- Looping straps at each end to tie sweep across waterways or on boats for dragging
- Easily attaches to sorbent booms



Model No.	Dimensions L x W	Absorbency/Pkg. Gallons	Qty /Pkg.	Price /Each
<b>SWEEP - OIL ONLY</b>				
SEI049	100' x 19"	33	1	185.00

## OIL ONLY BILGE BOOMS

- 100% polypropylene
- Will not sink when fully saturated permitting easy retrieval
- Can be used indoors or outdoors, and will not absorb water
- Prevents odors by absorbing bacteria breeding oily residues



Model No.	Dimensions L x W	Absorbency/Pkg. Gallons	Qty /Pkg.	Price /Each
<b>BILGE BOOM - OIL ONLY</b>				
SEI051	18" x 5"	31	12	151.00
SEJ294	18" x 8"	31	10	205.00

## PREMIUM SORBENT BOOMS

- Made of a durable spunbond sock and net filled with 100% polypropylene particulate
- Oil only booms are used for marine spills, universal booms are used for large land spills
- Durable rope runs between the sock and net allowing all tension to remain on the rope
- Hooks and clips at ends and 18" provide overlap at connection points
- Quick snaps provide easy handling and permit to attach multiple lengths together
- UV resistant for up to 12 months
- Oil only booms are made from 100% polypropylene, and absorb more than 25x their weight
- Universal booms are made from a polypropylene and cellulose blend, and absorb more than 18x their weight
- Polypropylene and cellulose blend absorption capacities far exceed those of 100% cellulose sorbents



Model No.	Dimensions L x W	Absorbency/Pkg. Gallons	Qty /Pkg.	Price /Each
<b>BOOMS - OIL ONLY</b>				
SDK911	120" x 5"	35	4	163.00
SEH952	120" x 8"	70	4	225.00
<b>BOOMS - UNIVERSAL</b>				
SEH999	120" x 5"	35	4	165.00
SEI001	120" x 8"	70	4	225.00



## SORBENT SOCKS

- Durable polypropylene shell prevents tearing and offers maximum flexibility
- Perfect for surrounding leaking machinery and drains
- Best suited to surround spills when easy containment and clean up is required
- Oil only and hazmat socks are made from 100% polypropylene, and absorb more than 25x their weight
- Universal socks are made from a polypropylene and cellulose blend, and absorb more than 18x their weight
- Polypropylene and cellulose blend absorption capacities far exceed those of 100% cellulose sorbents



Model No.	Dimensions			Absorbency/Pkg. Gallons	Qty /Pkg.	Price /Each
	L"	x	W"			
<b>OIL ONLY</b>						
SEH953	48	x	3	25	12	79.50
SEJ937	48	x	3	45	25	156.00
SEH955	120	x	3	45	10	129.00
<b>UNIVERSAL</b>						
SEJ938	48	x	3	20	12	63.95
SEI002	48	x	3	40	25	122.00
SEI047	48	x	3	50	30	134.00
SEJ025	48	x	3	65	40	165.00
SEJ026	96	x	3	65	20	160.00
SEI048	120	x	3	40	10	95.00
<b>HAZMAT</b>						
SEJ941	48	x	3	40	25	228.00
SEI011	96	x	3	50	15	168.00
SEI004	120	x	3	45	10	134.00



SEJ937



SEI002



SEI004

## DRUM COVER ABSORBENT PADS

- 100% polypropylene
- Precut to fit 55-gallon drums perfectly with a cut out bung hole
- Retains pump drips and drum leaks at the source and away from surrounding areas
- Keeps drum tops and floors clean and dry



SEI050

SEI053



Model No.	Diameter"	Absorbency/Pkg. Gallons	Qty /Pkg.	Price /Each
SEI050	22	10	25	145.00
<b>UNIVERSAL</b>				
SEI053	22	10	25	150.00

## DRIP PANS

- Pans are filled with sorbent pillows which keep liquids contained and prevents splashing
- Convenient, versatile, and easy to use around the work environment
- Best suited for placing under drums or machinery, and any other areas where drips occur
- The perfect solution for continuous leaks



SEI052

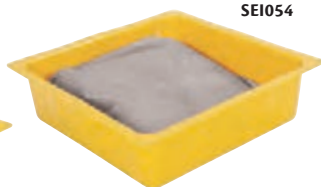

SEI054



Model No.	Dimensions				Absorbency/Pkg. Gallons	Qty /Pkg.	Price /Each
	L"	x	W"	H"			
<b>OIL ONLY</b>							
SEI052	10 1/2	x	10 1/2	x	3	1	14.50
<b>UNIVERSAL</b>							
SEI054	10 1/2	x	10 1/2	x	3	1	19.50

## SORBENT PILLOWS

- The perfect sorbent solution to trap drips and leaks
- Designed to recover and absorb large volumes of liquid
- Pillows can slide underneath dispensing units and machines to contain constant drips
- Oil only pillows are made from 100% polypropylene, and absorb more than 25x their weight
- Universal pillows are made from a polypropylene and cellulose blend, and absorb more than 18x their weight
- Polypropylene and cellulose blend absorption capacities far exceed those of 100% cellulose sorbents



SEH956



SEI005



Model No.	Dimensions			Absorbency/Pkg. Gallons	Qty /Pkg.	Price /Each
	L"	x	W"			
<b>OIL ONLY</b>						
SEH956	18	x	8	25	10	78.50
SEH957	18	x	18	40	10	144.00
<b>UNIVERSAL</b>						
SEJ028	18	x	8	30	10	99.00
SEJ029	18	x	18	45	10	155.00
<b>HAZMAT</b>						
SEI006	18	x	8	30	10	92.00
SEI005	18	x	18	45	10	150.00

# SPILL CONTROL MANAGEMENT SUPPLIES

## ECOPOLYBLEND™ SPILL TRAY

- Lightweight and low-profile design for small-scale spill control
- Made of 100% recycled polyethylene, these eco-friendly spill trays will not rust or corrode
- Raised rib bottom adds rigidity and keeps contents out of spills
- Perfect for pouring and filling applications
- Rated for service temperatures between -30° to 120°F (-34 to 49°C)



Model No.	Mfg. No.	Dimensions				Spill Capacity gal.	Price /Each
		L"	x	W"	x H"		
SEB201	28715	46	x	16	x 5 1/2	12	180.00
SEB202	28716	38	x	26	x 5 1/2	20	236.00
SEB203	28717	47 1/2	x	23	x 5 1/2	20	258.00
SEB204	28718	37 3/4	x	34	x 5 1/2	23	275.00
SEB205	28719	47	x	33	x 5 1/2	29	325.00

## SPILL BERMS®

- Non-absorbing berms stop machine leaks from spreading and are easily cleaned for repeated use
- Flexible, urethane design will bend to follow any curve or angle needed
- Contains leaks, and reduces slip hazards
- Allows quick and easy cleanup or recycling of liquids
- Can be cut to various lengths to meet custom needs
- Interlocking end joints on all models create longer lengths and are self-sealing except model number SEI129 which requires connectors and corners



Model No.	Description	Dimensions				Price /Each
		L"	x	W"	x H"	
SEI128	Low Profile	120	x	2 1/4	x 1 3/8	1089.00
SEI129	Ultra	120	x	4	x 2 1/4	1485.00
SEI130	Ultra Plus	60	x	4	x 4 1/2	1235.00
SEI131	Connector for SEI129	-		-		109.00
SEI132	Corner for SEI129	-		-		265.00

## POLY-LABTRAY™

### BRINGS SPILL PROTECTION TO THE LABORATORY BENCH!

- Reduces unrecoverable spills and overflows of liquid and free-flowing powder chemicals during the transfer of materials in the lab
- Holds four one gallon bottles
- Removable grate for easy cleaning, 20 3/4" L x 17 1/4" W
- Molded-in corner spout makes waste disposal clean, easy and efficient
- 40-lb. static load weight
- 2.5 US gallon sump capacity



Model No.	Mfg. No.	Exterior Dimensions				Wt. lbs.	Price /Each
		L"	x	W"	x H"		
SB768	5248-YE	25.5	x	22	x 3.25	6.5	245.00

## CUSTOMIZABLE DIVERTER BERM SYSTEM KITS

- Create a square or rectangular containment area
- Perfect for creating a barrier around stationary machines or equipment
- The straight sections can easily be cut with a utility knife in order to customize your area
- Includes: (2) 27' Straight sections, (4) 2" Corners, (6) Sili-Thane® sealant cartridges



Model No.	Mfg. No.	Height"	Price /Each
SGQ615	48-254-DBKIT	2	1489.00

## POLY-SPILLPAD™ PADS

- Handles spent batteries, 5-gallon pail, 16 US gallon drums and your small jobs
- Sturdy chemically resistant fabric provides protection, while an inner polyethylene beam keeps incidental spills contained
- Lightweight and easily moved on floor or travels to prevent incidental spills
- Large sump area allows for an extended response time
- Removable 100% polyethylene grate allows easy access to sump



Model No.	Mfg. No.	Exterior Dimensions				Sump Cap. US Gal.	Load Bearing Cap. lbs.	Wt. lbs.	Price /Each
		L"	x	W"	x H"				
SD519	5600-YE	24	x	24	x 2	2	4000	13	425.00
SD520	5610-YE	31 1/2	x	54	x 2 1/4	7.5	8000	21	685.00
SD521	5620-YE	55 1/2	x	55	x 2 1/2	12	16000	25	1079.00



## STORM SENTINEL™ DRAINS

- Adjustable storm drain and catch basin insert
- Catches oil and sediment headed into storm drains and sewers
- Equipped with an oil-absorbent media in a screened bag
- 300 GPM overflow rate helps avoid ponding
- Requires no special tools to install
- Dispose of the used insert according to company policy and all applicable laws and regulations
- Helps comply with NPDES, 40 CFR 122.26 (1999) when used as Best Management Practice in Storm Water Pollution Prevention Plans
- Fits size: 16" x 20" up to 28" x 36"
- Custom sizes available
- Length: 24"
- Width: 26"
- Guard Style: Sediment



SAS051



SAS050

Model No.	Mfg. No.	Description	Price /Each
SAS051	4341-1B	Rectangular	199.00
SAS050	4340-1B	Round or Oval	205.00

## STORMWATER DRAINGUARDS

- Prevents oil and other contaminants from entering water systems and drains
- Designed for use in industrial facilities, construction sites, parking lots and retail outlets
- Can remove up to 0.87 gallons of oil and 40 lbs. of sediments
- Ideal to seal around drains, storm sewer inlets or in front of curb culverts



Priced per Package

Model No.	Dimensions			Qty /Pkg.	Wt. lbs.	Price /Each
	L"	x	W"			
SEI122	48	x	36	1	1	64.50
SEI123	48	x	36	10	1	629.00

## DRAIN SEAL MATS

- Constructed of 100% solid tacky polyurethane
- Reversible, light weight and easy to use
- Cost effective reusable solution for emergency chemical spills
- Ideal to seal around drains, storm sewer inlets or in front of curb culverts



SEI093

SEI103

SEI099



## NEOPRENE DRAIN COVERS

- Prevents contaminants from entering drain
- Resists oil, water and most aggressive chemicals, non-absorbing
- Cleans easily with soap and water between uses

Model No.	Mfg. No.	Dimensions				Price /Each	
		L"	x	W"	H"		
SH104	Drain-Cover	36	x	36	x	1/16	56.50
SAP060	Drain-Cover-48	48	x	48	x	1/16	115.00



Model No.	Dimensions			Price /Each	
	L"	x	W"		
<b>DRAIN SEALS – SQUARE</b>					
SEI091	18	x	18	3/8	205.00
SEI092	24	x	24	3/8	319.00
SEI093	36	x	36	3/8	615.00
SEI094	42	x	42	3/8	835.00
SEI095	48	x	48	3/8	1059.00
SEI096	54	x	54	3/8	1289.00
<b>DRAIN SEALS – RECTANGULAR</b>					
SEI097	18	x	60	3/8	729.00
SEI098	36	x	60	3/8	1269.00
<b>DRAIN SEALS – CIRCULAR</b>					
SEI099	12 Dia.	x	3/8 H	159.00	
SEI100	20 Dia.	x	3/8 H	269.00	
SEI101	30 Dia.	x	3/8 H	415.00	
SEI102	42 Dia.	x	3/8 H	675.00	
<b>WALLMOUNT HOLDER</b>					
SEI103	Fits 18" and 24" Drain Seals			349.00	
SEI104	Fits 36" Drain Seals			499.00	
SEI105	Fits 48" Drain Seals			479.00	



# SPILL CONTROL MANAGEMENT SUPPLIES

## PLUG N'DIKE® SEALANTS

- Easy to use and convenient emergency sealant
- Seals immediately and sticks to unprepared, dirty and crumpled surfaces
- Non-toxic and non-flammable blend of high absorption polymers
- Can be used with hydrocarbons and water-based chemicals
- Antifreeze mix prevents hardening in cold weather applications
- Dry, granular blend can be mixed with water to form a paste

SEI072



Model No.	Format	Qty /Pkg.	Price /Each
<b>PLUG N'DIKE® PASTE</b>			
SEI071	10-oz. Jar	1	32.50
SEI072	1-lb. Jar	1	58.00
<b>PLUG N'DIKE® GRANULAR</b>			
SEI080	5-Gallon Pail	1	175.00
SEI081	1-Gallon Jug	4	51.10

## PIPE LEAK DIVERTERS

- Fast and efficient response to leaks eliminating slip hazards
- High chemical resistance
- 7-gallon fluid capacity
- Convenient hose connector with cap
- Hose can then be directed to proper drainage point
- Fits 5/8" and 1/2" standard garden hose, not included
- Lightweight, reusable and easy to store
- Material: HDPE
- Includes four bungee cords



Model No.	Mfg No.	Dimensions'	Price /Each
SEI661	46R18-YE	18 x 18	189.00

## SANDLESS SANDBAGS

- Protect property from flood water with heavy stackable barrier that will last for months
- Contains a super absorbent polymer that expands on contact with water
- More compact and lightweight than a traditional sandbag before activation
- Dry Weight: 0.55 lbs./pc
- Saturated Weight: 44 lbs.
- Saturated Dimensions: 22" x 15" x 4"
- Dry Dimensions: 22" x 15" x 0.25"
- Colour: Black
- Qty/Pkg.: 10
- **Priced per Package**
- Model No. SGW035
- Price/Each \$69.95



## ROOF LEAK DIVERTER

- Divert roof leaks away from work areas
- Durable and chemical resistant PVC material with sewn in brass grommets
- Standard 3/4" hose connection
- Hose and bungee cords sold separately
- Material: PVC



Model No.	Dimensions'	Price /Each
SGX009	3 x 3	49.95
SGX010	5 x 5	64.99

## PIPE LEAK DIVERTER

- Provides a fast and efficient response to leaks, eliminating slipping hazards
- Features high chemical resistance
- Lightweight, reusable, and easy to store
- Features convenient hose connector with cap, hose can then be directed to a drainage point
- Fits 5/8" and 1/2" standard garden hose (sold separately)
- Material: HDPE
- Hose Connector Size: 5/8", 1/2"
- Fluid Capacity: 7 Gal.



Model No.	Dimensions'	Price /Each
SGY102	1.5 x 1.5	99.00

## DRIP DAM™ ROOF LEAK DIVERTERS

- Fast and efficient response to overhead leaks
- Flow rate of over 3 gallons per minute
- Convenient hose connector with cap
- Fits 5/8" and 1/2" standard garden hose, not included
- Hose can then be directed to proper drainage point
- High chemical resistance
- Lightweight, reusable and easy to store
- Material: HDPE
- Attach with four bungee cords or rubber tie downs (not included)



Model No.	Mfg No.	Dimensions'	Price /Each
SEI133	460303-YE	3 x 3	109.00
SEI134	460306-YE	3 x 6	115.00
SEI136	460610-YE	6 x 10	255.00
SEI657	460505-YE	5 x 5	125.00
SEI658	460606-YE	6 x 6	209.00
SGQ590	461010-YE	10 x 10	369.00
SEI659	461012-YE	10 x 12	425.00
SEI660	461212-YE	12 x 12	475.00
<b>HOSE</b>			
SDM218	46-HOSE-10	10 x 3/4" dia	135.00
SDM219	46-HOSE-25	25 x 3/4" dia	185.00

## SPILL KIT TOOLS

- Rugged, non-sparking, anti-static and chemically resistant
- European-thread handle required for brushes
- Model SAL503 with blue bristles

Brushes



Scrapers



Scoops

Dustpan

Model No.	Mfg. No.	Description	Dimensions L" x W" x H"	Price /Each
<b>DUSTPANS</b>				
SAL490	6350	Dustpan Charcoal Grey, Polypropylene	12 x 12 x 4	9.99
<b>SCOOPS</b>				
SAL491	64005	Small, 32 oz. - White	11.5 x 4.3 x 3	7.39
SAL492	64002	Small, 32 oz. - Green	11.5 x 4.3 x 3	7.39
SAL494	65005	Large, 82 oz. - White	15.1 x 5.9 x 3.3	8.89
SAL495	65002	Large, 82 oz. - Green	15.1 x 5.9 x 3.3	8.89
<b>SCRAPERS</b>				
SAL497	69615	Small, White	8 x 3 x -	6.99
SAL498	69612	Small, Green	8 x 3 x -	6.99
SAL500	69625	Large, White	9 x 4 x -	8.39
SAL501	69622	Large, Green	9 x 4 x -	8.39



Model No.	Mfg. No.	Description	Dimensions L" x W"	Price /Each
<b>BROOM</b>				
SAL503	31783	Polypropylene Broom, Soft	3 x 16	45.50
SAL504	2915	Polyester Broom, Stiff	3 x 13	58.90
SAL505	2920	Polyester Broom, Stiff	3 x 20	69.50

## SAFETY SHOVELS

- Non-sparking polypropylene safety shovels are versatile, lightweight and will not rust or corrode, chemical resistant
- Two-piece construction disassembles for easy storage, easy to use locking mechanism
- Working temperature range: -22°F/-30°C to 176°F/80°C; intermittent use may increase temperature range
- Emergency blade shovels are injection molded, structural poly compact shovel which collapses for easy storage
- Variety of blade and handle configurations
- Ideal for spill kits, hazmat response and environmental clean up

SAL457

SAL465

SAL471



Remco



Model No.	Mfg. No.	Description	Handle	Blade Size L" x W"	Overall Length"	Price /Each
<b>INDUSTRIAL SHOVELS (ONE-PIECE)</b>						
SAL460	RG6981	Small Blade, Grey	Standard D-Grip	10 x 6	38	49.50
<b>HYGIENIC SHOVELS (ONE-PIECE)</b>						
SAL457	69815	Small Blade, White	Standard D-Grip	10 x 6	38	49.50
SAL458	69813	Small Blade, Blue	Standard D-Grip	10 x 6	38	49.50
SAL459	665379	Small Blade, Green	Standard D-Grip	10 x 6	38	49.50
SAL461	69825	Large Blade, White	Standard D-Grip	14 x 6	42	51.90
SAL462	69823	Large Blade, Blue	Standard D-Grip	14 x 6	42	51.90
SAL463	69822	Large Blade, Green	Standard D-Grip	14 x 6	42	51.90
<b>SAFETY SHOVELS (TWO-PIECE)</b>						
SAL465	68925S	Medium Blade	Standard D-Grip	10 x 6	39	75.50
SAL468	68965S	Medium Blade	Extended D-Grip	10 x 6	44	78.50
SAL470	68985S	Medium Blade	Short D-Grip	10 x 6	33	78.90
SAL471	69005S	Large Blade	Standard D-Grip	14 x 7	41	99.90
<b>SAFETY ALL BLACK (TWO-PIECE)</b>						
SAL467	6896BKSS	Medium Blade	Extended D-Grip	10 x 6	44	78.50
<b>EMERGENCY BLADE SHOVELS</b>						
SAL473	6880EBO	Compact Orange	T-Grip	12 x 10	24-36	47.50
SAL474	6880EBG	Compact Grey	T-Grip	12 x 10	24-36	47.50

Emergency Blade Shovels



# SPILL CONTROL MANAGEMENT SUPPLIES

## OPTISORB® GRANULAR ABSORBENT

- Made from diatomaceous earth, 100% natural and moisture free mineral
- All purpose absorbent designed for the quick clean up of water, oil and grease
- Very cost effective for every day spills
- Environmentally friendly



Model No.	Format	Price /Each
SEI076	25-lb. Bag	25.50

## OIL-DRI® GENERAL-PURPOSE ABSORBENT

- Superior retention of liquids such as oil, grease, hydraulic fluid, water and other liquid spills, all non-aggressive fluids
- Virtually dust free, lowering airborne contamination
- Its high absorbency, low density, enables more scoops per pound
- Packaged in a poly bag making it next to unbreakable and water resistant
- Composed of light grey fuller's earth



Model No.	Mfg. No.	Format	Price /Each
SI965	18002	40 lb. (18 kg)	46.60
SAR327	15005	33 lb. (15 kg)	41.60

## OIL-DRI® QUICK SORB® ABSORBENT

- Specially designed to absorb up to twice as much fluid per pound as conventional clay
- Smaller granules offer more surface area for greater absorption power
- Strong granules improve traction and will not break down when saturated
- Comes in an easy-to-carry store pail
- 20-lb. (9.1-kg) pail

Model No. SAR329  
Mfg. No. 05000  
Price/Each \$65.00



## SAFE T SORB® PREMIUM OIL ABSORBENT

- 100% fuller's earth
- All-purpose absorbent designed for the quick clean up of water, oil, and grease
- Made from montmorillonite, a naturally occurring mineral with superior absorption ability
- Packaged in a leak-resistant, moisture-proof poly bag
- Works on any concrete surface
- 40-lb. bag

Model No. SR927  
Mfg No. 2410096825  
Price/Each \$35.70



## ALL-PURPOSE GRANULAR SORBENT

- 99.5% natural diatomaceous earth
- Safely and quickly absorb water, grease, paint, alcohols, solvents, coolants, oils, and fuels
- Useful for spill containment, as a traction aid, and odour control
- For use in industrial plants, refineries, garages, workshops, machine shops, warehouses, and anywhere else a spill may occur
- Accepted for use in Canadian Food Processing Facilities



Model No.	Format	Price /Each
SGX202	25-lb. bag (11.3 kg)	19.95

## ABSORB-N-DRY® ABSORBENT

- Traditional clay based absorbent
- Very cost effective for every day spills
- Granular mesh size creates a safe non-slip work surface



Model No.	Format	Price /Each
SEI085	25-lb. Bag	16.75
SEI084	50-lb. Bag	22.00

## OIL-DRI® PREMIUM ABSORBENT

- Superior moisture extraction process increases absorption and minimizes dust
- Non-toxic, virtually dust-free product absorbs aggressive and non-aggressive fluids in minutes and leaves no residue
- Holds liquids in; will not breakdown and turn to mud
- Low density: more scoops per pound saves money
- 25-lb. (11.25-kg) bag

Model No. SAR328  
Mfg. No. 11001  
Price/Each \$43.50



## QUALISORB™ GOLD ABSORBENT

- Non-corrosive, non-toxic product that offers the best absorbency
- Absorbs almost twice as much as other product in water or oil
- Can be used in all applications, even for toxic waste absorption
- It absorbs spills in no time leaving floor safe and dry
- Used in plants, refineries, repair shops, machine shops and garages
- 20-lb. (9.1-kg) bag

Model No. SAJ503  
Mfg. No. 628N  
Price/Each \$20.95





# SPILL CONTROL MANAGEMENT SUPPLIES

## CHEETAH SORB ABSORBENT

- Loose particulate
- Highly absorbent, dust free and incinerable
- Environmentally friendly and silica free
- Very cost effective oil sorbent
- Green/eco friendly



Model No.	Format	Qty /Pkg.	Price /Each
SAL267	30-lb. Bag	1	29.95

## OIL GATOR® ABSORBENT

- All natural cellulosic fibres
- When activated with the addition of moisture, the active bacteria will rapidly use all the available hydrocarbons as a food source
- Non carcinogenic and non abrasive
- Stops leaking of contaminants into the soil or groundwater
- Ideal for hydrocarbons



Model No.	Format	Qty /Pkg.	Price /Each
SEI158	30-lb. Bag	1	72.00

## PEAT MOSS ABSORBENT

- Organic heat treated peat moss
- Hydrophobic and biodegradable granular
- Contains less than 5% moisture
- Ideal absorbent for fine sheens and concrete stains
- Absorbs up to 15 times its weight in hydrocarbons



Model No.	Format	Qty /Pkg.	Price /Each
SEI074	20-lb. Bag	1	55.00

## ENSORB® SUPER ABSORBENT

- 15 to 20 times the absorption capacity of clay-based products
- Virtually unlimited uses as a dry absorbent that is safe in all applications
- Picks up all liquids, of any viscosity, off any hard surface
- Turns the spilled liquid into a solid that can be disposed of easily
- Lightweight and simple to use, it dramatically reduces cleanup costs
- Not injurious to soil, cement, asphalt, tile, plants, animals, or humans
- Contains no reactive chemicals, is not toxic or flammable



SFU672

SEC928

## VERMICULITE ABSORBENT

- All recycled vermiculite
- Ideal for solidification, packaging, and incineration
- One bag can absorb up to 4 gallons of water
- Excellent for fuel blending
- 4 cu.ft. bag



SEI578

Model No.	Grade	Qty /Pkg.	Price /Each
SEJ805	3	1	85.00
SEI578	4	1	85.00

## ULTRA-RESPONSE SHOVEL® QUICK-RELEASE SHAFT

- Quick release shaft breaks down for easy storage and transport
- Length: 37"
- Material: Polyethylene



Model No.	Mfg. No.	Price/Each
SGQ539	0404	74.90



Model No.	Mfg. No.	Description	Wt. lbs.	Price/Each
SFU672	ENP D503	1 gallon jug	3	48.50
SEC928	ENP D225	1.5 cu.ft. Bag	11	41.90

## ACID NEUTRALIZERS

- Neutralizes and absorbs aggressive acid/ caustic spills
- Color changing indicators to signify when neutralization has occurred



SFM476



SFM470



SFM471

Model No.	Type	Format	Qty /Pkg.	Price /Each
<b>NEUTRALIZERS - ACID</b>				
SFM470	Dry	0.96 kg Shaker	1	26.00
SFM471	Dry	20 kg Pail	1	335.00
SFM472	Dry	4 kg Pail	1	82.00
SFM473	Liquid	5-Gallon Pail	1	460.00
<b>NEUTRALIZERS - CAUSTIC (BASE)</b>				
SFM474	Dry	0.85 kg Shaker	1	44.00
SFM475	Dry	20 kg Pail	1	485.00
SFM476	Dry	3.5 kg Pail	1	105.00

# SPILL CONTROL MANAGEMENT SUPPLIES

## 95-GALLON SPILL KITS



Mobile Version



Description	Oil Only Model No.	Price /Each	Universal Model No.	Price /Each	Hazmat Model No.	Price /Each
Spill Kit	SEJ262	905.00	SEI167	915.00	SEJ263	989.00
Mobile Spill Kit	SEJ264	1040.00	SEI494	1099.00	SEJ265	1125.00
Replacement Kit*	SEJ824	465.00	SEI873	485.00	SEJ826	555.00

\*Replacement kit does not include original package container

### CONTENTS:

Qty	Description	Oil Only	Universal	Hazmat
50	Sorbent Pads, 15" x 17"	SEI140	SEJ772	SEJ773
5	Sorbent Socks, 3" x 48"	SEI141	SEI156	SEJ775
5	Sorbent Pillows, 8" x 18"	SEI143	SEJ776	SEI153
4	Sorbent Booms, 5" x 10'	SDK910	SEI149	SEI149
1	Sorbent Roll, 15" x 150'	SEH950	SEH963	SEJ009
1	Drain Cover, 36" x 36"	SH104	SH104	SH104
1	Caution Tape, 3" x 300'	SFJ602	SFJ602	SFJ602
2	Pairs Nitrile Gloves, XL (10)	SEF086	SEF086	SEF086
2	Pairs Safety Goggles, One Size	SEF219	SEF219	SEF219
2	Microporous Coveralls, XL	SEK358	SEK358	SEK358
10	Disposal Bags, 26" x 36"	SEI272	SEI272	SEI272

Replacement Containers	Capacity	Model No.
Polyethylene Overpack Drum, 32" x 26" x 42"	95 Gallons	SDM248*
Mobile Polyethylene Overpack Drum, 32" x 26" x 42"	95 Gallons	SAH549**

\* UN 1H2/X295/S, DOT 49 CFR 173.3(c), EPA, SPCC and NPDES

\*\* UN 1H2/X125/S, DOT 49 CFR 173.3(c), EPA, SPCC and NPDES

## 95-GALLON SHOP SPILL KITS

Description	Oil Only Model No.	Price /Each	Universal Model No.	Price /Each	Hazmat Model No.	Price /Each
Spill Kit	SEJ266	765.00	SEI168	795.00	SAL321	805.00
Mobile Spill Kit	SEJ268	879.00	SEI495	938.00	SEJ269	965.00
Replacement Kit*	SEJ827	305.00	SEI947	380.00	SEJ829	385.00

\*Replacement kit does not include original package container

### CONTENTS:

Qty	Description	Oil Only	Universal	Hazmat
100	Sorbent Pads, 15" x 17"	SEI140	SEJ772	SEJ773
10	Sorbent Socks, 3" x 120"	SEI142	SEI157	SEI151
8	Sorbent Pillows, 8" x 18"	SEI143	SEJ776	SEI153
1	Drain Cover, 36" x 36"	SH104	SH104	SH104
1	Caution Tape, 3" x 300'	SFJ602	SFJ602	SFJ602
2	Pairs Nitrile Gloves, XL (10)	SEF086	SEF086	SEF086
2	Pairs Safety Goggles, One Size	SEF219	SEF219	SEF219
2	Microporous Coveralls, XL	SEK358	SEK358	SEK358
10	Disposal Bags, 26" x 36"	SEI272	SEI272	SEI272

Replacement Containers	Capacity	Model No.
Polyethylene Overpack Drum, 32" x 26" x 42"	95 Gallons	SDM248*
Mobile Polyethylene Overpack Drum, 32" x 26" x 42"	95 Gallons	SAH549**

\* UN 1H2/X295/S, DOT 49 CFR 173.3(c), EPA, SPCC and NPDES

\*\* UN 1H2/X125/S, DOT 49 CFR 173.3(c), EPA, SPCC and NPDES

## 97-GALLON SPILL KITS



Mobile Version



Description	Oil Only Model No.	Price /Each	Universal Model No.	Price /Each
Spill Kit	SEJ260	830.00	SEI166	915.00
Mobile Spill Kit	SEJ261	935.00	SEI493	995.00
Replacement Kit*	SEJ823	323.00	SG967	470.00

\*Replacement kit does not include original package container

### CONTENTS:

Qty	Description	Oil Only	Universal
100	Sorbent Pads, 15" x 17"	SEI140	SEJ772
10	Sorbent Socks, 3" x 120"	SEI142	SEI157
8	Sorbent Pillows, 8" x 18"	SEI143	SEJ776
1	Drain Cover, 36" x 36"	SH104	SH104
1	Caution Tape, 3" x 300'	SFJ602	SFJ602
2	Pairs Nitrile Gloves, XL (10)	SEF086	SEF086
2	Pairs Safety Goggles, One Size	SEF219	SEF219
2	Microporous Coveralls, XL	SEK358	SEK358
10	Disposal Bags, 26" x 36"	SEI272	SEI272

Replacement Containers	Capacity	Model No.
Spill Control Locker, 42" x 30" x 29"	97 Gallons	ND702
Mobile Spill Control Locker, 42" x 30" x 29"	97 Gallons	SEI518

Mobile Version



## 95-GALLON INDUSTRIAL SPILL KITS

Description	Oil Only Model No.	Price /Each
Spill Kit	SAK243	895.00
Mobile Spill Kit	SAK245	1045.00
Replacement Kit*	SEI874	464.00

\*Replacement kit does not include original package container

### CONTENTS:

Qty	Description	Oil Only
50	Sorbent Pads, 15" x 17"	SEI140
5	Sorbent Socks, 3" x 48"	SEI141
5	Sorbent Pillows, 8" x 18"	SEI143
4	Sorbent Booms, 5" x 10"	SDK910
1	Sorbent Roll, 15" x 150"	SEH950
1	Drain Cover, 36" x 36"	SH104
1	Caution Tape, 3" x 300'	SFJ602
2	Pairs Nitrile Gloves, XL (10)	SEF086
2	Pairs Safety Goggles, One Size	SEF219
2	Microporous Coveralls, XL	SEK358
10	Disposal Bags, 26" x 36"	SEI272

Replacement Containers	Capacity	Model No.
Polyethylene Overpack Drum, 32" x 26" x 42"	95 Gallons	SDM248*
Mobile Polyethylene Overpack Drum, 32" x 26" x 42"	95 Gallons	SAH549**

\*UN 1H2/X295/S, DOT 49 CFR 173.3(c), EPA, SPCC and NPDES \*\*UN 1H2/X125/S, DOT 49 CFR 173.3(c), EPA, SPCC and NPDES

## 95-GALLON SPILL KITS

- Spill Type: Universal
- Container Type: Salvage Drum
- Absorption Capacity: 95 US gal.

### CONTENTS:

Qty	Description	Universal
1	Polyethylene Overpack Drum	SDM248
150	Sorbent pads, 15" x 18"	SEJ772
20	Sorbent socks, 3" x 48"	SEI156
5	Sorbent Pillows, 18" x 18"	SEJ777
2	Pairs Nitrile Gloves, XL (10)	SEF086
10	Disposal Bags, 26" x 36"	SEI272

Model No. SGD801  
Price/Each \$825.00

SPILL KIT REFILL  
Model No. SHC551  
Price/Each \$355.00

## 95-GALLON ECONOMY SPILL KITS

Description	Oil Only Model No.	Price /Each	Universal Model No.	Price /Each
Spill Kit	SAK251	795.00	SEJ272	799.00
Mobile Spill Kit	SAK253	940.00	SEJ273	945.00
Replacement Kit*	SEJ830	324.00	SEJ831	355.00

\*Replacement kit does not include original package container

### CONTENTS:

Qty	Description	Oil Only	Universal
100	Sorbent Pads, 15" x 17"	SEI140	SEJ772
4	Sorbent Booms, 5" x 10'	SDK910	SEI149
1	Drain Cover, 36" x 36"	SH104	SH104
1	Caution Tape, 3" x 300'	SFJ602	SFJ602
2	Pairs Nitrile Gloves, XL (10)	SEF086	SEF086
2	Pairs Safety Goggles, One Size	SEF219	SEF219
2	Microporous Coveralls, XL	SEK358	SEK358
10	Disposal Bags, 26" x 36"	SEI272	SEI272

Replacement Containers	Capacity	Model No.
Polyethylene Overpack Drum, 32" x 26" x 42"	95 Gallons	SDM248*
Mobile Polyethylene Overpack Drum, 32" x 26" x 42"	95 Gallons	SAH549**

\*UN 1H2/X295/S, DOT 49 CFR 173.3(c), EPA, SPCC and NPDES \*\*UN 1H2/X125/S, DOT 49 CFR 173.3(c), EPA, SPCC and NPDES

### Mobile Version



### Mobile Version





# SPILL CONTROL MANAGEMENT SUPPLIES

## 63-GALLON SPILL KITS

Description	Oil Only Model No.	Price /Each	Universal Model No.	Price /Each
Mobile Spill Kit	SEI198	655.00	SEI197	675.00
Replacement Kit*	SEI943	375.00	SEI944	420.00

\*Replacement kit does not include original package container

### CONTENTS:

Qty	Description	Oil Only	Universal
100	Sorbent Pads, 15" x 17"	SEI140	SEJ772
4	Sorbent Socks, 3" x 120"	SEI142	SEI157
4	Sorbent Pillows, 18" x 18"	SEI144	SEJ777
1	Drain Cover, 36" x 36"	SH104	SH104
1	Optisorb®, 25-lb. Bag	SEI076	SEI076
2	Pairs Nitrile Gloves, XL (10)	SEF086	SEF086
2	Pair Safety Goggles, One Size	SEF219	SEF219
3	Disposal Bags, 26" x 36"	SEI272	SEI272

### Mobile Version



**ZENITH®**  
Safety Products

SEI198



## 55-GALLON SPILL KIT

- Spill Type: Universal
- Container Type: Drum
- Absorption Capacity: 55 US gal.

**ZENITH®**  
Safety Products

### CONTENTS:

Qty	Description	Universal
1	Blue Polyethylene Drum	DC525
100	Sorbent pads, 15" x 18"	SEI988
12	Sorbent socks, 3" x 48"	SEI156
2	Sorbent socks, 3" x 10"	SEI157
2	Pairs Nitrile Gloves, XL (10)	SEF086
1	Caution Tape, 3" x 300'	SFJ602
4	Disposal Bags, 26" x 36"	SEI272

Model No. SGD800  
Price/Each \$418.00

### REFILL KIT

Model No. SHC358  
Price/Each \$235.00



## 63-GALLON SPILL KIT

- Includes: 100 Sorbent Pads (15" x 17"), 4 Sorbent Socks (3" x 120"), 4 Sorbent Pillows (18" x 18"), 1 Drain Cover (36" x 36"), 1 All-Purpose Granular Sorbent (25-lb. Bag), 2 Pairs Nitrile Gloves, XL (10), 2 Pairs of Safety Goggles (One Size), 3 Disposal Bags (26" x 36")
- Container Type: Bin

**ZENITH®**  
Safety Products



Model No.	Spill Type	Price /Each
SHB360	Universal	655.00
SHB361	Oil Only	635.00

## 55-GALLON SPILL KITS

Description	Oil Only Model No.	Price /Each	Universal Model No.	Price /Each	Hazmat Model No.	Price /Each
Spill Kit	SEI196	375.00	SEI195	397.00	SEJ271	420.00
Replacement Kit*	SEI576	229.00	SEJ833	235.00	SEJ834	255.00

\*Replacement kit does not include original package container

### CONTENTS:

Qty	Description	Oil Only	Universal	Hazmat
50	Sorbent Pads, 15" x 17"	SEI140	SEJ772	SEJ773
5	Sorbent Socks, 3" x 48"	SEI141	SEI156	SEJ775
3	Sorbent Socks, 3" x 120"	SEI142	SEI157	SEI151
1	Drain Cover, 36" x 36"	SH104	SH104	SH104
1	Pair Nitrile Gloves, XL (10)	SEF086	SEF086	SEF086
2	Microporous Coveralls, XL	SEK358	SEK358	SEK358
1	Pair Safety Goggles, One Size	SEF219	SEF219	SEF219
3	Disposal Bags, 26" x 36"	SEI272	SEI272	SEI272

Replacement Containers	Capacity	Model No.
Black Polyethylene Drum	55 Gallons	DC527*

\* UN Compliance: 1H1/Y1.9/150



**ZENITH**  
Safety Products

SEI196

## 31-GALLON TOOL BOX SPILL KITS

Description	Oil Only Model No.	Price /Each	Universal Model No.	Price /Each
Spill Kit	SEI261	266.00	SEI260	288.00
Replacement Kit*	SEJ835	185.00	SEJ836	199.00

\*Replacement kit does not include original package container

### CONTENTS:

Qty	Description	Oil Only	Universal
25	Sorbent Pads, 15" x 17"	SEI140	SEJ772
4	Sorbent Socks, 3" x 48"	SEI141	SEI156
5	Sorbent Pillows, 8" x 18"	SEI143	SEJ776
1	Oil Gator®, 30-lb. Bag	SEI158	SEI158
1	Drain Cover, 36" x 36"	SH104	SH104
2	Pairs Nitrile Gloves, XL (10)	SEF086	SEF086
2	Pairs Safety Goggles, One Size	SEF219	SEF219
3	Disposal Bags, 26" x 36"	SEI272	SEI272



**ZENITH**  
Safety Products

SEI261

## 30-GALLON TOOL KADDIE SPILL KITS

Description	Oil Only Model No.	Price /Each	Universal Model No.	Price /Each
Mobile Spill Kit	SEI200	1095.00	SEI199	1115.00
Replacement Kit*	SEI953	199.00	SEI952	222.00

\*Replacement kit does not include original package container

### CONTENTS:

Qty	Description	Oil Only	Universal
40	Sorbent Pads, 15" x 17"	SEI140	SEJ772
5	Sorbent Socks, 3" x 48"	SEI141	SEI156
2	Sorbent Socks, 3" x 120"	SEI142	SEI157
8	Sorbent Pillows, 8" x 18"	SEI143	SEJ776
60	Industrial Wipes	JD479	JD479
2	Pairs Nitrile Gloves, XL (10)	SEF086	SEF086
1	Pair Safety Goggles, One Size	SEF219	SEF219
2	Disposal Bags, 26" x 36"	SEI272	SEI272



**ZENITH**  
Safety Products

SEI200

# SPILL CONTROL MANAGEMENT SUPPLIES

## 30-GALLON SHOP SPILL KITS

Description	Oil Only Model No.	Price /Each	Universal Model No.	Price /Each
Spill Kit	SEI163	308.00	SEJ274	316.00
Replacement Kit	SEJ837	175.00	SEJ838	185.00

\*Replacement kit does not include original package container

### CONTENTS:

Qty	Description	Oil Only	Universal
50	Sorbent Pads, 15" x 17"	SEI140	SEJ772
4	Sorbent Socks, 3" x 48"	SEI141	SEI156
1	Drain Cover, 36" x 36"	SH104	SH104
2	Pairs Nitrile Gloves, XL (10)	SEF086	SEF086
5	Disposal Bags, 26" x 36"	SEI272	SEI272

Replacement Containers	Capacity	Model No.
Blue Polyethylene Drum	30 Gallons	DC535*

\* UN Compliance: 1H2/Y150/S



**ZENITH**  
Safety Products

SEI163

## 30-GALLON SPILL KITS

Description	Oil Only Model No.	Price /Each	Universal Model No.	Price /Each	Hazmat Model No.	Price /Each
Spill Kit	SEJ275	352.00	SEI165	358.00	SEJ276	386.00
Replacement Kit*	SEJ839	220.00	SEI614	235.00	SEJ840	255.00

\*Replacement kit does not include original package container

### CONTENTS:

Qty	Description	Oil Only	Universal	Hazmat
75	Sorbent Pads, 15" x 17"	SEI140	SEJ772	SEJ773
4	Sorbent Socks, 3" x 120"	SEI142	SEI157	SEI151
1	Drain Cover, 36" x 36"	SH104	SH104	SH104
1	Caution Tape, 3" x 300'	SFJ602	SFJ602	SFJ602
2	Pairs Nitrile Gloves, XL (10)	SEF086	SEF086	SEF086
2	Pairs Safety Goggles, One Size	SEF219	SEF219	SEF219
2	Microporous Coveralls, XL	SEK358	SEK358	SEK358
5	Disposal Bags, 26" x 36"	SEI272	SEI272	SEI272

Replacement Containers	Capacity	Model No.
Blue Polyethylene Drum	30 Gallons	DC535*

\* UN Compliance: 1H2/Y150/S



**ZENITH**  
Safety Products

SEI165

## 20-GALLON SPILL KITS

Description	Oil Only Model No.	Price /Each	Universal Model No.	Price /Each	Hazmat Model No.	Price /Each
Spill Kit	SEJ291	244.00	SEI164	252.00	SEJ277	285.00
Replacement Kit*	SEJ841	125.00	SEJ842	133.00	SEJ843	155.00

\*Replacement kit does not include original package container

### CONTENTS:

Qty	Description	Oil Only	Universal	Hazmat
50	Sorbent Pads, 15" x 17"	SEI140	SEJ772	SEJ773
4	Sorbent Socks, 3" x 48"	SEI141	SEI156	SEJ775
2	Sorbent Pillows, 8" x 18"	SEI143	SEJ776	SEI153
1	Pair Nitrile Gloves, XL (10)	SEF086	SEF086	SEF086
1	Pair Safety Goggles, One Size	SEF219	SEF219	SEF219
1	Disposal Bag, 26" x 36"	SEI272	SEI272	SEI272

Replacement Containers	Capacity	Model No.
Yellow Polyethylene Container	20 Gallons	SAG189*

\* UN 1H2/X75/S, UN 1H2/Y100/S, DOT 49 CFR 173.3 (c), EPA, SPCC and NPDES



**ZENITH**  
Safety Products

SEI164



# SPILL CONTROL MANAGEMENT SUPPLIES

## 17-GALLON WESTERN CANADA SPILL KITS



Description	Oil Only Model No.	Price /Each	Universal Model No.	Price /Each	Hazmat Model No.	Price /Each
Spill Kit	SEI194	308.00	SEI193	315.00	SEJ280	330.00
Replacement Kit*	SEJ844	282.00	SEJ845	296.00	SEJ846	310.00

\*Replacement kit does not include original package container

### CONTENTS:

Qty	Description	Oil Only	Universal	Hazmat
10	Sorbent Pads, 15" x 17"	SEI140	SEJ772	SEJ773
3	Sorbent Socks, 3" x 48"	SEI141	SEI156	SEJ775
1	Optisorb®, 2-lb. Bag	SEI270	SEI270	SEI270
1	Peat Moss, 2-lb. Bag	SEI271	SEI271	SEI271
1	Plug n' Dike®, 10 oz.	SEI071	SEI071	SEI071
1	Scoop, Non-Sparking	SEI280	SEI280	SEI280
1	Pair Nitrile Gloves, XL (10)	SEF086	SEF086	SEF086
1	Containment Pool, 20-gal.	SAQ189	SAQ189	SAQ189
1	Disposal Bag, 26" x 36"	SEI272	SEI272	SEI272

Replacement Containers	Capacity	Model No.
Red Nylon Bag	N/A	SEI557

## 10-GALLON VEHICLE SPILL KIT



Description	Oil Only Model No.	Price /Each	Universal Model No.	Price /Each	Hazmat Model No.	Price /Each
Spill Kit	SEI184	105.00	SEI183	109.00	SEJ284	117.00
Replacement Kit*	SEI888	71.50	SEI889	80.00	SEJ851	87.50

\*Replacement kit does not include original package container

### CONTENTS:

Qty	Description	Oil Only	Universal	Hazmat
20	Sorbent Pads, 15" x 17"	SEI140	SEJ772	SEJ773
2	Sorbent Socks, 3" x 48"	SEI141	SEI156	SEJ775
2	Sorbent Pillows, 8" x 18"	SEI143	SEJ776	SEI153
1	Pair Nitrile Gloves, XL (10)	SEF086	SEF086	SEF086
1	Pair Safety Goggles, One Size	SEF219	SEF219	SEF219
2	Disposal Bags, 26" x 36"	SEI272	SEI272	SEI272

## 16-GALLON SPILL KITS



Description	Oil Only Model No.	Price /Each	Universal Model No.	Price /Each	Hazmat Model No.	Price /Each
Spill Kit	SEJ278	172.00	SEI162	185.00	SEJ279	205.00
Replacement Kit*	SEJ847	105.00	SEJ848	115.00	SEJ849	140.00

\*Replacement kit does not include original package container

### CONTENTS:

Qty	Description	Oil Only	Universal	Hazmat
5	Sorbent Socks, 3" x 48"	SEI141	SEI156	SEJ775
5	Sorbent Pillows, 8" x 18"	SEI143	SEJ776	SEI153
1	Pair Nitrile Gloves, XL (10)	SEF086	SEF086	SEF086
1	Pair Safety Goggles, One Size	SEF219	SEF219	SEF219
3	Disposal Bags, 26" x 36"	SEI272	SEI272	SEI272

Replacement Containers	Capacity	Model No.
Blue Polyethylene Pail	16 Gallons	DC538*

\* UN Compliance: 1H2/X65.0/S

## 10-GALLON CAPACITY TRUCK SPILL KITS



Description	Oil Only Model No.	Price /Each	Universal Model No.	Price /Each	Hazmat Model No.	Price /Each
Spill Kit - Plastic Zipper Bag	SEI186	65.00	SEI185	72.00	SEJ281	92.50
Spill Kit - Nylon Bag	SEI188	85.00	SEI187	95.00	SEJ282	105.00
Spill Kit - Blue Drum	SEI190	185.00	SEI189	188.00	SEJ283	205.00
Replacement Kit*	SEJ669	60.00	SEJ770	66.00	SEJ850	81.00

\*Replacement kit does not include original package container

### CONTENTS:

Qty	Description	Oil Only	Universal	Hazmat
10	Sorbent Pads, 15" x 17"	SEI140	SEJ772	SEJ773
3	Sorbent Socks, 3" x 48"	SEI141	SEI156	SEJ775
2	Sorbent Pillows, 8" x 18"	SEI143	SEJ776	SEI153
1	Pair Nitrile Gloves, XL (10)	SEF086	SEF086	SEF086
1	Pair Safety Goggles, One Size	SEF219	SEF219	SEF219
1	Disposal Bag, 26" x 36"	SEI272	SEI272	SEI272

Replacement Containers	Capacity	Model No.
Plastic Zipper Bag	N/A	SDL059
Blue Drum	10 Gallons	DC538*

\* UN Compliance: 1H2/Y45.5/S

# SPILL CONTROL MANAGEMENT SUPPLIES

## 10-GALLON SERVICE VEHICLE SPILL KITS

SEI192



Description	Oil Only Model No.	Price /Each	Universal Model No.	Price /Each	Hazmat Model No.	Price /Each
Spill Kit	SEI192	88.50	SEI191	95.00	SEJ285	105.00
Replacement Kit*	SEJ852	66.00	SEJ853	76.00	SEJ854	88.00

\*Replacement kit does not include original package container

### CONTENTS:

Qty	Description	Oil Only	Universal	Hazmat
2	Sorbent Socks, 3" x 48"	SEI141	SEI156	SEJ775
4	Sorbent Pillows, 8" x 18"	SEI143	SEJ776	SEI153
1	Oil Gator®, 5-lb. Bag	SEI159	SEI159	SEI159
2	Disposal Bags, 26" x 36"	SEI272	SEI272	SEI272

## 5-GALLON HAZMAT SPILL KITS

SEJ286



Description	Hazmat Model No.	Price /Each
Spill Kit	SEJ286	97.00
Replacement Kit*	SEJ859	65.00

\*Replacement kit does not include original package container

### CONTENTS:

Qty	Description	Hazmat
5	Sorbent Socks, 3" x 48"	SEJ775
1	Pair Nitrile Gloves, XL (10)	SEF086
1	Pair Safety Goggles, One Size	SEF219
2	Disposal Bags, 26" x 36"	SEI272

Replacement Containers	Capacity	Model No.
White Polyethylene Pail	5 Gallons	CB046
White Polyethylene Pail Cover	N/A	CB045

## 10-GALLON SPILL KIT

- 10 Oil-Only Sorbent Pads, 15" x 17"
- 10 Universal Sorbent Pads, 15" x 18"
- 3 Oil-Only Sorbent Socks, 3" x 48"
- 1 Optisorb (2-lb. Bag)
- 1 Repair putty, 4 oz.
- 3 Disposal Bag, 26" x 36"
- 1 Pair Nitrile Gloves, XL (10)



SGX529



Model No.	Description	Price /Each
SGX529*	Plastic Zipper Bag	96.00
SGX530	Nylon Bag	71.00
SGX531*	Nylon Bag	105.00

\*Includes 1 Repair putty, 4 oz.

## TOOL BOX SPILL KIT

- Includes: 25 Sorbent pads (15" x 17"), 4 Sorbent socks (3" x 48"), 5 Sorbent pillows (8" x 18"), 1 All-Purpose Granular Sorbent (25-lb. Bag), 1 Drain cover 36" x 36", 2 Pairs nitrile gloves XL (10), 2 Pairs safety goggles (one size), 3 Disposal bags (26" x 36")
- Container Type: Bin
- Absorption Capacity: 31 US gal.



Model No.	Spill Type	Price /Each
SHB362	Universal	270.00
SHB363	Oil Only	240.00

# SPILL CONTROL MANAGEMENT SUPPLIES

## 5-GALLON SPILL KITS



Description	Oil Only Model No.	Price /Each	Universal Model No.	Price /Each	Hazmat Model No.	Price /Each
Spill Kit	SEJ975	69.00	SEI160	80.50	SEJ286	97.00
Replacement Kit*	SEJ976	50.00	SEJ858	55.00	SEJ859	65.00

\*Replacement kit does not include original package container

### CONTENTS:

Qty	Description	Oil Only	Universal	Hazmat
5	Sorbent Socks, 3" x 48"	SEI141	SEI156	SEJ775
1	Pair Nitrile Gloves, XL (10)	SEF086	SEF086	SEF086
1	Pair Safety Goggles, One Size	SEF219	SEF219	SEF219
2	Disposal Bags, 26" x 36"	SEI272	SEI272	SEI272

Replacement Containers	Capacity	Model No.
White Polyethylene Pail	5 Gallons	CB046
White Polyethylene Pail Cover	N/A	CB045

## 5-GALLON SPILL KIT

- Spill Type: Oil Only
- Container Type: Pail
- Absorption Capacity: 5 US gal.



### CONTENTS:

Qty	Description	Oil Only
1	White Polyethylene Pail	CB046
10	Sorbent pads, 15" x 17"	SGE019
2	Sorbent socks, 3" x 48"	SEI141
1	Oil Gator, 5-lb. bag	SEI159
1	Pair Vinyl Exam Gloves, XL (10)	SAQ703
2	Disposal Bags, 26" x 36"	SEI272

Model No. SGD798  
Price/Each \$80.50



## 5-GALLON ECONOMY SPILL KITS



Description	Oil Only Model No.	Price /Each	Universal Model No.	Price /Each	Hazmat Model No.	Price /Each
Spill Kit	SEI266	55.00	SEI265	62.00	SEJ287	64.00
Replacement Kit*	SEJ860	38.00	SEJ861	42.00	SEJ862	47.00

\*Replacement kit does not include original package container

### CONTENTS:

Qty	Description	Oil Only	Universal	Hazmat
10	Sorbent Pads, 15" x 17"	SEI140	SEJ772	SEJ773
1	Sorbent Sock, 3" x 48"	SEI141	SEI156	SEJ775
1	Pair Nitrile Gloves, XL (10)	SEF086	SEF086	SEF086
1	Disposal Bag, 26" x 36"	SEI272	SEI272	SEI272

## 5-GALLON SPILL KIT

- Spill Type: Oil Only
- Container Type: Bag
- Absorption Capacity: 5 US gal.



### CONTENTS:

Qty	Description	Oil Only
10	Sorbent pads, 15" x 17"	SGE019
3	Sorbent socks, 3" x 48"	SEI141
1	Pair Nitrile Gloves, XL (10)	SAP323
1	Disposal Bag, 26" x 36"	SEI272

Model No. SGD799  
Price/Each \$58.00



## FIRST RESPONDERS SPILL KITS

### CONTENTS:

Qty	Description
1	Plastic Carry Case
4	Sorbent Pads, 15" x 17"
1	Sorbent Sock, 3" x 48"
1	Repair Putty, 4 oz.
1	Pair Nitrile Gloves (10)
1	Pair Safety Goggles, One Size
1	Disposal Bag, 26" x 36"



Description	Oil Only Model No.	Price /Each	Universal Model No.	Price /Each
Spill Kit	SEJ288	188.00	SEJ289	199.00





# SPILL CONTROL MANAGEMENT SUPPLIES

## 20-GALLON ACID SPILL KITS



### CONTENTS:

Qty	Description	Model No.
8	Acid Neutralizer, 0.96 kg Shaker	SFM470
15	Sorbent Pads, 15" x 17"	SEJ772
2	Sorbent Socks, 3" x 48"	SEI156
2	Microporous Coveralls, XL	SEK358
2	Pairs Nitrile Gloves, XL (10)	SEF086
2	Pairs Safety Goggles, One Size	SEF219
5	Disposal Bags, 26" x 36"	SEI272



Model No.	Description	Price /Each
SEI263	Acid Spill Kit	415.00
SEJ863	Replacement Kit*	330.00

\*Replacement kit does not include original package container

Replacement Containers	Capacity	Model No.
Yellow Polyethylene Container	20 Gallons	SAG189*

\*UN 1H2/X75/S, UN 1H2/Y100/S, DOT 49 CFR 173.3 (c), EPA, SPCC and NPDES

## 20-GALLON BATTERY ACID SPILL KITS



### CONTENTS:

Qty	Description	Model No.
8	Acid Neutralizer, 0.96 kg Shaker	SFM470
20	Sorbent Pads, 15" x 17"	SEJ772
3	Sorbent Socks, 3" x 48"	SEI156
2	Microporous Coveralls, XL	SEK358
2	Pairs Nitrile Gloves, XL (10)	SEF086
2	Pairs Safety Goggles, One Size	SEF219
3	Disposal Bags, 26" x 36"	SEI272



Model No.	Description	Price /Each
SEI264	Battery Spill Kit	435.00
SEJ864	Replacement Kit*	320.00

\*Replacement kit does not include original package container

Replacement Containers	Capacity	Model No.
Yellow Polyethylene Container	20 Gallons	SAG189*

\*UN 1H2/X75/S, UN 1H2/Y100/S, DOT 49 CFR 173.3 (c), EPA, SPCC and NPDES

## 20-GALLON CAUSTIC SPILL KITS



### CONTENTS:

Qty	Description	Model No.
8	Caustic Neutralizer, 0.85 kg Shaker	SFM474
15	Sorbent Pads, 15" x 17"	SEJ772
2	Sorbent Socks, 3" x 48"	SEI156
2	Microporous Coveralls, XL	SEK358
2	Pairs Nitrile Gloves, XL (10)	SEF086
2	Pairs Safety Goggles, One Size	SEF219
2	Disposal Bags, 26" x 36"	SEI272



Model No.	Description	Price /Each
SEI262	Caustic Spill Kit	505.00
SEJ865	Replacement Kit*	345.00

\*Replacement kit does not include original package container

Replacement Containers	Capacity	Model No.
Yellow Polyethylene Container	20 Gallons	SAG189*

\*UN 1H2/X75/S, UN 1H2/Y100/S, DOT 49 CFR 173.3 (c), EPA, SPCC and NPDES

## BATTERY NEUTRALIZER

- Used to clean and neutralize the acid residues on the top of batteries before performing maintenance
- Neutralizes the sulphuric acid residues that get on workwear, typically going unnoticed until a hole develops
- Spray bottle is capped with the sprayer separate
- Type: Liquid



Model No.	Container Size	Price /Each
SGH496	950 mL	18.50

# SPILL CONTROL MANAGEMENT SUPPLIES

## 50-ML MERCURY SPILL KITS



### CONTENTS:

Qty	Description
1	Plastic Carry Case
1	Mercury Powder
1	Mercury Vapour Supressant
2	Sorbent Pads, 15" x 17"
1	Dust Mask
1	Pair Disposable Boots
2	Pairs Nitrile Gloves, XL (10)
1	Dust Pan With Brush
1	Respirator
3	Disposal Bags, 26" x 36"



Model No.	Description	Price /Each
SEI268	Spill Kit	480.00

## 40-ML MERCURY SPILL KITS



### CONTENTS:

Qty	Description
1	Mercury Absorb Jar
2	Mercury Absorb Sponges
1	Mercury Absorb Powder, 500 g
1	Pair Nitrile Gloves, XL (10)
1	Pair Safety Goggles, One Size
1	Disposal Bag, 26" x 36"



Model No.	Description	Price /Each
SEJ552	Spill Kit	143.00

## LAB ACID/BASE SPILL KITS



### CONTENTS:

Qty	Description
1	Plastic Carry Case
4	Sorbent Pads, 15" x 17"
1	Acid Neutralizer
1	Base Neutralizer
1	Pair Safety Goggles, One Size
1	Pair Nitrile Gloves, XL (10)
1	Disposal Bag, 26" x 36"



Model No.	Description	Price /Each
SEI269	Spill Kit	165.00

## UNIVERSAL PRECAUTION BLOODBORNE PATHOGEN SPILL KITS



### CONTENTS:

Qty	Description
1	Poly Bag
1	Protective Apron
1	Combo Mask/Safety Shield
1	Red Z <sup>®</sup> Solidifier, 10 g Pouch
1	Scoop
1	SaniZide Plus <sup>®</sup> , Germicidal Wipe, 8" x 8"
1	P.A.W.S. <sup>®</sup> Antimicrobial Hand Wipe, 5" x 8"
1	Pair Nitrile Gloves, XL (10)
1	Pair Safety Goggles, One Size
1	Red Bio Hazard Waste Bag, 24" x 24"
1	Twist Tie
1	Identification Tag and Instructions



Model No.	Description	Price /Each
SEJ290	Spill Kit	33.50

# MOVING YOU FORWARD

KLETON

# SPILL CONTROL MANAGEMENT SUPPLIES

## UNIVERSAL POLY-DRUM FUNNEL™

- Patented scalloped design, high sidewall and bung fitting holders
- For use with 30 and 55 US gallon drums
- Funnels nest for compact shipment
- Safety funnel includes a non-sparking safety bung closure with flame arrestor for use with flammable liquids
- Optional cover keeps the weather and other hazards out
- Easy installation
- **Exterior dimensions:** 26" dia. x 5 1/2" H
- **Interior dimensions:** 22" dia. x 4" H



SAH566

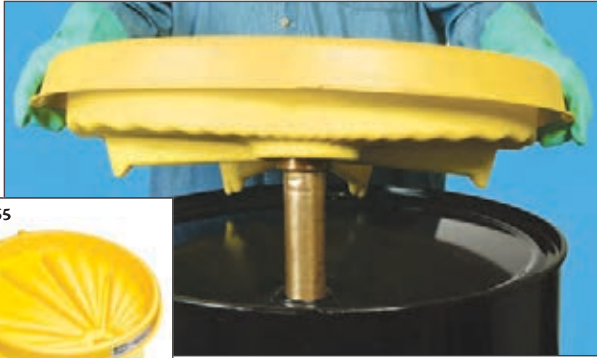

SAH565

Model No.	Mfg. No.	Description	Wt. lbs.	Price /Each
SAH565	3004-YE	Funnel	3	239.00
SAH566	3004-YE-SF	Safety Funnel	5	999.00
SAH567	3040-YE	Funnel Cover	3	269.00

## POLY-DRUM TOPPER™ COVERS

- Snaps directly onto any 55 US gallon open or closed-head drum to keep out debris and protect drum tops
- Easy installation
- **Exterior dimensions:** 25 1/2" dia. x 3 3/4" H



Model No.	Mfg. No.	Description	Wt. lbs.	Price /Each
SAQ193	3065-BK	Poly-Drum Topper™	1.5	195.00

## SAFETY DRUM FUNNELS

- Suitable for handling flammables, minimise potentially dangerous spills
- Large 10 3/4" mouth provides quick dumping
- Steel construction with 6" flame arrestor for the DA102 and 32" flame arrestor for the DA101
- Hinged cover with fusiblelink reduces spread of vapours
- FM approved



Model No.	Mfg. No.	Description	NPS"	Wt. lbs.	Price /Each
DA101	8205	32" Flame Arrestor	2	29	809.00
DA102	8207	6" Flame Arrestor	3/4	11	533.00



## DRUMS-UP™ TRAYS

### THE INCIDENTAL SPILL SOLUTION!

- Catch liquid before it reaches the floor, reducing the risk of slip and fall injuries
- Ideal for use as a drum pumping station
- Secondary containment unit features a unique geometric design covering more floor area
- Drain spout makes emptying easy

### DRUMS-UP™

- Contains drips for containers up to 55 US gallons
- Control nuisance spills from drums with a 20 US gallon capacity
- Convenient pour spout

### DRUMS-UP JR™

- Containment for 16 to 30 US gallon drums and 5-gallon pails
- 7 1/2 US gallon capacity

Model No.	Mfg. No.	Description	Dimensions Dia" x H"	Wt. lbs.	Price /Each
DA104	8091-YE	Drums-Up™	37 1/2 x 7 1/2	6	435.00
SD361	8200-YE	Drums-Up Jr.™	22 3/4 x 7 1/2	2	269.00



SD361



Drum not included

DA104





## LEAK CONTAINMENT DRUM DOLLIES

- Polyethylene dolly will not dent, corrode, or rust
- Handles +30 imp gal./37 US gal. and 45 imp. gal./55 US gal. drums
- Solid bottom construction with a 2" lip contains spills up to 5 L
- Overall diameter: 24 1/4"
- Capacity: 1000 lbs.
- Colour: Grey



DC465

Model No.	Caster Type	Caster Size"	O.A. Height"	Price /Each
DC465	Polyurethane	3	6 1/4	139.00
DC466	Polyolefin	3	6 1/2	139.00
DC467	Polyolefin	4	7 1/4	139.00

## POLY-SPILLCART™ CARTS

### ELIMINATES RISK OF SPILLS DURING TRANSPORT!

- Tough polyethylene construction will not rust or corrode
- Dual drain plugs let you empty sump easily
- Removable structural foam grate for easy cleaning
- Built-in tool tray
- 10" polyolefin wheels
- Rear wheels move around freely, brake for secure position
- Available as an all terrain cart (ATC) with heavy-duty aggressive wheels
- 66 1/2" L x 29" W x 43 3/4" H
- 57-gallon sump capacity
- 500-lb load bearing capacity



Model No.	Mfg. No.	Description	Wt. lbs.	Price /Each
SB766	5200-YE	Poly-Spillcart™	115	1829.00
SR438*	5200-YE-A	Poly-Spillcart™ ATC	123	2125.00

\* All Terrain Cart with heavy-duty pneumatic rubber wheels

## POLY-COLLECTOR™

- Portable hazardous materials collection systems
- Built of tough UV-stabilized polyethylene for excellent chemical resistance to a broad range of industrial materials
- Equipped with the universal Poly-Drum Funnel™ to prevent over-spills while allowing multiple oil filters, pails, and cans to drain at once
- Ideal for collecting waste oil, antifreeze and maintenance chemicals
- Drum dolly included

### POLY-COLLECTOR™ 66

- Poly outer shell holds 70 US gallons
- Inner drum holds 55 US gallons
- **Interior dimensions:** 27" top dia. x 25 3/4" bottom dia. x 29 1/4" H
- Available with shell only, 70 US gallon sump capacity



SE556



SE554



Model No.	Mfg. No.	Description	Exterior Dimensions			Wt. lbs.	Price /Each
			Top Dia"	x	Bottom Dia." x H"		
SE554	8001-YE	W/Steel Drum	32 1/2	x	26 1/4 x 42	92	1209.00
SE555	8002-YE	W/Poly Drum	32 1/2	x	26 1/4 x 42	78	1205.00
SE556	8075-YE	Shell Only	32 1/2	x	26 1/4 x 31	30	469.00

## SPILL SCOOTER™

- 100% polyethylene construction
- Contains incidental spills and drips
- Spout included for easy draining
- Holds up to 55 US gallon drums
- Optional metal T-handle available separately, 36 5/8" long
- 35" Dia. x 9" H
- 500-lb load bearing capacity
- 11 US gallon capacity



Model No.	Mfg. No.	Description	Wt. lbs.	Price /Each
SB767	5205-YE	Spill Scooter™	22	519.00
SC554	5206-BK	T-Handle	3	149.00

# SPILL CONTROL MANAGEMENT SUPPLIES

## WHEELED OVERPACK® SALVAGE DRUMS

- First mobile 1-piece Overpack® that can handle 55 US gallon drums
- Salvage drum and dolly all in one, eliminates the need for a separate dolly
- UN rated salvage drums, ideal for spill kits
- Built-in handles and 6" wheels allow for easy maneuverability
- Easy steering through doorways and around obstacles
- Polyolefin Wheels

### WHEELED OVERPACK® 50

- 50 US gallon sump capacity
- **Exterior dimensions:** 24" top Dia. x 18 1/2" bottom Dia. x 45 1/2" H
- **Interior dimensions:** 20" top Dia. x 17 3/4" bottom Dia. x 36" H

### WHEELED OVERPACK® 95

- 95 US gallon sump capacity
- **Exterior dimensions:** 31 1/2" top Dia. x 25 3/4" bottom Dia. x 47 1/2" H
- **Interior dimensions:** 27" top Dia. x 25" bottom Dia. x 38 1/2" H



Model No.	Mfg. No.	Description	Wt. lbs.	Price /Each
SAL223	1259-YE	Overpack® 50	38	695.00
SAH549	1299-YE	Overpack® 95	56	805.00

## WHEELED POLY-SPILLPAKS

- Perfect for storage, containment, or when used as a spill kit when spill transportation is not a factor
- Wheeled Poly-Overpaks eliminates the need for a separate dolly
- Ideal for onsite drum storage and containment applications when a UN rated drum is unnecessary
- Rugged, non-corrosive, UV resistant design ensures that your SpillPak will handle the toughest jobs any time, every time



Model No.	Mfg. No.	Dimensions Dia." x H"	Spill Capacity US Gal.	Wt. lbs.	Price /Each
SDN457	1259-BD	24 x 45.5	50	41	669.00
SDN458	1299-BD	31 x 47.5	95	56	725.00

## POLY-DOLLY®

### THE MULTI-FUNCTIONAL, TWO-WHEEL DISPENSING STATION!

- Holds 55 US gallon drums
- Tilts to become an efficient self-dispensing station
- Acts as its own secondary containment unit with patented sidewall sump
- Integrally molded handles for extra strength
- Double looped strap for easy loading
- Accessible to forklift from the rear
- Raised ribbed dispensing well
- Drain plug for removal of contents from sump
- All Terrain Dolly with heavy-duty semi-pneumatic rubber wheels
- 69" L x 32 1/2" W x 26 1/2" H
- 70 US gallon sump capacity
- 600-lb handling capacity
- Eliminates the need for a separate dolly



Drum not included



SB769



Model No.	Mfg. No.	Description	Wt. lbs.	Price /Each
SB769	5300-YE	Poly-Dolly®	83	1565.00
SB770*	5300-YE-A	Poly-Dolly® ATD	91	1825.00
SR442	6005-BK	Universal Well Liner	1.5	199.00

\* All Terrain Dolly with heavy-duty semi-pneumatic rubber wheels

## DRUM & OVERPACK LIFTERS

- Drum Lifter is designed to lift and transport a standard 55 US Gal. steel drum 22.5" in diameter
- Drum lifer can also lift an 85 US Gal. overpack or salvage drum 26" in diameter
- Drum lifter can be used on closed "tight" head drums type with head intact, or with open head drums with lid securely clamped in place
- The broad faced grippers spread holding force to minimize pressure on drum
- Unit is load tested at the factory at 125% of rated capacity as per ASME B30.20
- Lifting Capacity: 1000 lbs./454 kg



Model No.	Mfg. No.	Wt. lbs.	Price /Each
DC608	91	18.5	355.00

## THE POLY-RACK™ SYSTEM

THE MOST EFFICIENT DISPENSING/STORAGE SYSTEM!

### POLY-RACKER™

- One-piece polyethylene rack that holds two 55 US gallon drums securely in place
- 100 plus gallon containment sump ensures spill safety even in worst-case drum leaks
- Deep dispensing well easily holds 5-gallon pails while containing incidental spills and splashes in a ribbed bottom without contaminating the sump
- Dispensing wells have a scalloped edge so pails can be easily removed
- Both sides of the unit have a drain plug
- Entire unit can be transported by forklift
- Rated to hold up to 3000 lbs.
- Can easily handle up to six drums when used with two Poly-Stacker™

### POLY-STACKER™

- Holds two 55 US gallon drums
- Can be quickly stacked with a forklift
- Any spills from the second and third level falls into the dispensing well for containment and easy cleanup
- Increase safety and productivity by adding Poly-Shelf™ to the Poly-Racker™ System

### MULTI-PURPOSE RACKER/STACKER™

- Holds up to two 55 US gallon drums
- Unit can be placed on the floor (no sump) or on a pallet
- Use with the Poly-Shelf™ for easy dispensing into 5 or 6-gallon pails
- Forkliftable

### POLY-SHELF™

- It easily attaches to Poly-Stacker™
- Allows simultaneous dispensing from all drums
- A hole in the bottom of the Poly-Shelf™ drains into the dispensing well in the Poly-Racker™



Universal Well Liner



Drums, pail & pallet not included

Model No.	Mfg. No.	Description	Max Capacity lbs.	Dimensions				Wt. lbs.	Price /Each	
				L"	x	W"	x			H"
SB771	6000-YE	Poly-Racker™	3000	49	x	53	x	23	105	1595.00
SB772	6002-YE	Poly-Stacker™	2400	49	x	41	x	13	50	719.00
SR466	6006-YE	Single Poly-Racker™	1600	31	x	53	x	32	95	985.00
SR467	6007-YE	Single Poly-Stacker™	800	31	x	40 1/2	x	20	45	699.00
SE410	6004-YE	Multi-Purpose Racker/Stacker™	2400	48 1/2	x	41	x	20	60	839.00
SB773*	6003-YE	Poly-Shelf™	60	17	x	22	x	17 1/2	8	289.00
SR442	6005-BK	Universal® Well Liner	-	14 1/2	x	17 1/2	x	2 1/2	1.5	199.00

\* Use only with Poly-Stacker™ or Single Poly-Stacker™

## NESTABLE SPILL PALLETS

- Captures drips and spills
- Removable grates for easy access to the sump and provide a slip resistant surface
- Molded from chemically compatible polyethylene
- Great for secondary spill containment applications
- Nestable for easy storage and shipment
- Side wall grooves allow units to be linked together for customization and security
- Regulations: EPA 40 CFR 264.175, SPCC NPDES and UFC



Model No.	Mfg. No.	Description	Dimensions			Sump Cap. Gal.	Load Capacity lbs.	Wt. lbs.	Price /Each		
			L"	x	W"					x	H"
SDM225	5222-BD	2-Drum Pallet	51	x	26	x	21	66	1000	46	549.00
SDM226	5222-BD-D	2-Drum Pallet w/Drain	51	x	26	x	21	66	1000	46	589.00
SDM227	5400-BD	4-Drum Pallet	54	x	54	x	10 1/2	66	2000	69	569.00
SDM228	5400-BD-D	4-Drum Pallet w/Drain	54	x	54	x	10 1/2	66	2000	69	605.00



# SPILL CONTROL MANAGEMENT SUPPLIES

## NESTABLE 2-DRUM POLY-SPILLPALLET™

- 100% polyethylene provides excellent chemical resistance
- Removable grates for easy cleaning
- Forkliftable on two sides
- Holds two 55 US gallon drums
- Load bearing capacity of 2000 lbs.
- Sump capacity of 66 US gallons
- Available with drain hole and plug
- Meets EPA 40 CFR 264.175
- Overall dimensions: 51" L x 26" W x 21" H



Model No.	Mfg. No.	Description	Wt. lbs.	Price /Each
SEI786	5222-YE	2-Drum Poly-Spillpallet™	54	655.00
SEI787	5222-YE-D	2-Drum Poly-Spillpallet™ w/Drain	54	725.00

## BLACK DIAMOND LOW PROFILE SPILL PALLET

- Recycled polyethylene construction won't rust or corrode
- Holds two 55-gallon drums for drip and leak protection
- Provides EPA compliant containment for 20-gallon drums and smaller
- Low profile design stays out of the way
- Connect units together with inverted U-channels
- Colour: Black



Model No.	Mfg. No.	Dimensions Length x Width x Height	Spill Capacity	Load Capacity	No. of Drums	Weight lbs.	Regulations	Price /Each
SGX547	5117-BD	49" x 24" x 6.5"	25.5 US gal.	3000 lbs.	2	38	EPA, SPCC, NPDES	329.00
SGX545	5116-BD	49" x 48" x 6.5"	51 US gal.	6000 lbs.	4	76	EPA, SPCC, NPDES	655.00
SGX543	5115-BD	72" x 49" x 6.5"	76.5 US gal.	9000 lbs.	6	114	EPA, SPCC, UFC, NPDES	985.00

## LOW-PROFILE IN-LINE POLY-SPILLPALLET™ 3000

- 100% polyethylene
- Holds four 55 US gallon drums
- Low 12" profile
- Non-skid, removable grates
- Load bearing capacity of 3000 lbs.
- Sump capacity of 66 US gallons
- Overall dimensions: 98" L x 25 1/4" W x 12" H
- Poly-Ramp™ allows for easy loading of pallet



Drums not included



Model No.	Mfg. No.	Description	Wt. lbs.	Price /Each
SB762	5102-YE	4-Drum Poly-Spillpallet™	78	975.00
SB763	5102-YE-D	4-Drum Poly-Spillpallet™ w/Drain	78	1045.00
SAQ186	5039-BK	Poly-Ramp™	65	795.00

## POLY-SPILLPALLET™ 6000

- Includes the same rugged features as the Poly-Spillpallet™ 2000
- Two removable grates
- Forkliftable from all sides
- Holds four 55 US gallon drums
- Load bearing capacity of 6000 lbs.
- Sump capacity of 83 US gallons
- Overall dimensions: 50" L x 50" W x 17" H



Drums not included



Model No.	Mfg. No.	Description	Wt. lbs.	Price /Each
SB795	5001-YE	4-Drum Poly-Spillpallet™	84	949.00
SB794	5001-YE-D	4-Drum Poly-Spillpallet™ w/Drain	84	1015.00

## POLY-SLIM-LINE™ SPILL PALLETS

- Offers all of the same advantages as the Poly-Spillpallet™
- Features a low 8.75" profile
- Load bearing capacity of 8000 lbs.
- Sump capacity of 66 US gallons
- Overall dimensions: 49" L x 49" W x 8.75" H
- Poly-Ramp™ allows for easy loading of pallet



Drums not included



Model No.	Mfg. No.	Description	Wt. lbs.	Price /Each
SE408	5400-YE	4-Drum Poly-Slim-Line™	84	635.00
SE409	5400-YE-D	4-Drum Poly-Slim-Line™ w/Drain	84	669.00
SAQ186	5039-BK	Poly-Ramp™	65	795.00

## ULTRA-SPILL PALLETS

- Specially constructed to support heavy loads and designed to be easily used and transported
- Constructed with a design called "The Cross of Life", which protects the pallet's structural integrity while bearing a heavy load over time
- 100% Polyethylene construction allows it to be compatible with a wide range of chemicals, while its low-rise walls give more accessibility for pouring
- Bright, safety yellow sidewalls are translucent, offering convenient visual leak detection
- Meets SPCC and EPA Container Storage Regulation 40 CFR 264.175 Spill Containment Regulations
- Sump Capacity: 66 US Gallons



Drums  
not included



Model No.	Mfg. No.	Description	Dimensions L" x W" x H"	Load Bearing Cap. lbs.	Wt. lbs.	Price /Each
SDL583	1010	2-Drum Spill Pallet	53 x 29 x 16 1/2	3000	63	875.00
SDL584	1011	2-Drum Spill Pallet w/Drain	53 x 29 x 16 1/2	3000	63	985.00
SDL585	1000	4-Drum Spill Pallet	53 x 53 x 11 3/4	6000	90	1029.00
SDL586	1001	4-Drum Spill Pallet w/Drain	53 x 53 x 11 3/4	6000	90	1095.00

## WORKSTATIONS™

- Tough, 1-piece polyethylene construction will not rust or corrode
- Low profile design and optional ramp make it easy to load
- Forkliftable when empty
- Large sump capacity catches incidental spills
- Removable heavy-duty structural foam grates for easy cleaning



Model No.	Mfg. No.	Description	Exterior Dimensions L" x W" x H"	Sump Cap. US Gallons	Load Bearing Cap. lbs.	Wt. lbs.	Price /Each
SGX548	5117-YE	2-Drum	49 x 24 x 6.5	25.5	3000	38	349.00
SGX546	5116-YE	4-Drum	49 x 48 x 6.5	51	6000	76	699.00
SGX544	5115-YE	6-Drum	72 x 49 x 6.5	76.5	9000	114	1049.00
SAQ187	5111-BK	Work Ramp™	25 1/2 x 46 x 6 1/4	-	1000	30	485.00

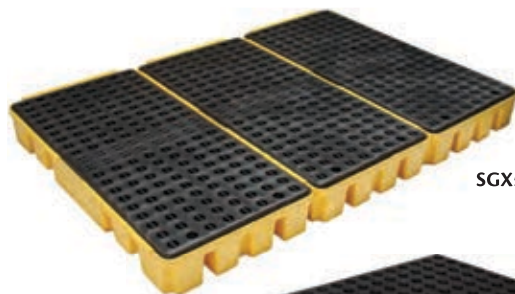

SGX544



SGX548

## SPILLPAL™ FLEXIBLE WORKSTATIONS

- Provides incidental spill control during temporary storage of equipment
- Can be used as a washdown pad or pumping station
- Alternative to hard plastic pallets
- Features 3" high foam sidewalls that spring back into place after any type of pressure is applied
- Folded unit ships easily
- When not using, store on a shelf, freeing up valuable floor space
- Easy drive-in and drive-out with a hand truck or forklift



Drums Not  
Included

Model No.	Mfg. No.	Description	Exterior Dim. L' x W' x H"	Sump Cap. US Gallons	Wt. lbs.	Price /Each
SAF814	5750-YE	1-Drum	2 x 2 x 4	7	2	225.00
SAF815	5755-YE	2-Drum	2 x 4 x 4	14	4	415.00
SAF816	5760-YE	4-Drum	4 x 4 x 4	29	5	579.00
SAF817	5765-YE	4-Drum In-Line	2 x 8 x 4	29	6	685.00
SAF818	5770-YE	6-Drum	4 x 6 x 4	44	7	859.00
SAF819	5775-YE	8-Drum	4 x 8 x 4	59	9	1045.00
SE553	7006-BK	Optional Grate	4 x 1.9 x 2	-	18	135.00
SAP041	7007-BK	Optional Grate	2.1 x 2 x 2	-	9	115.00



## ULTRA-SPILLDECK BLADDER SYSTEMS

- Hidden containment bladder automatically unfurls to capture large spills or drum leaks
- Low profile, rugged, double layer polyethylene containment decks
- Low 5" deck height allows safe and convenient drum loading, even without drum handling equipment
- Meets EPA container storage regulations 40 CFR 264.175 and Uniform Fire Code Spill Containment regulations

**Note:** Spill Decks require usage of the bladder attachment to meet EPA regulations



SE412

Model No.	Mfg. No.	Description	Dimensions L" x W" x H"	Total Containment Cap. US gallons	Wt. lbs.	Price /Each
SE411*	1320	1-Drum, 11 US Gal Cap.	25 7/8 x 30 1/2 x 5 3/4	77	27	665.00
SE412*	2329	2-Drum, 22 US Gal Cap.	52 x 30 1/2 x 5 3/4	88	44	979.00
SE413*	2330	4-Drum, 44 US Gal Cap.	52 x 56 5/8 x 5 3/4	110	66	1355.00
SE414*	2317	Bladder Attachment	25 1/8 x 4 5/8 x 4 5/8	-	4	339.00
SE415	2320	Replacement Bladder	66 x 58 (unfurled)	-	2	155.00

\* w/bladder



# SPILL CONTROL MANAGEMENT SUPPLIES

## DRUM HARDCOVER & SPILLPALLET™ SYSTEMS

- Ideal for indoor/outdoor storage of 55 US gallon drums
- Roll-top design allows it to be used in limited space or next to buildings where swing-open doors would be a problem
- Top or front loadable
- Poly-Ramp™ available to assist in the loading of drums
- Optional drain



**SI743**  
2-drum system

### 2-DRUM HARDCOVER & SPILLPALLET™

- Holds up to two 55 US gallon drums
- Used in conjunction with the Poly-Spillpallet™ 2000
- Load bearing capacity of 2000 lbs.
- Sump capacity of 58 US gallons
- Ramp extender to accommodate 17" high pallets

### 4-DRUM HARDCOVER & SPILLPALLET™

- Holds up to four 55 US gallon drums
- Used in conjunction with the Poly-Slim-Line™ 6000
- Load bearing capacity of 6000 lbs.
- Sump capacity of 66 US gallons

Model No.	Mfg. No.	Description	Ext. Dimensions			Wt. lbs.	Price /Each
			L"	x W"	x H"		
<b>2-DRUM SYSTEM</b>							
SI743	4062-YE	Hardcover and Spillpallet™	60	x 37	x 72	210	<b>3259.00</b>
SI744	4062-YE-D	Hardcover and Spillpallet™ w/Drain	60	x 37	x 72	210	<b>3309.00</b>
SAQ186	5039-BK	Poly-Ramp™	67	x 30 1/2	x 12 3/4	65	<b>795.00</b>
SI746	5038-BK	Ramp Extender	29 1/2	x 8 1/2	x 6 1/2	6	<b>215.00</b>
<b>4-DRUM SYSTEM</b>							
SI740	4064-YE	Hardcover and Spillpallet™	65	x 58	x 69	269	<b>3735.00</b>
SI741	4064-YE-D	Hardcover and Spillpallet™ w/Drain	65	x 58	x 69	269	<b>3785.00</b>
SAQ186	5039-BK	Poly-Ramp™	67	x 30 1/2	x 12 3/4	65	<b>795.00</b>

## ULTRA-HARD TOP P1 PLUS® 1-DRUM HARDTOP COVER SPILL CONTAINMENT UNITS

- The only 1-drum, lockable outdoor containment unit available
- Convenient "roll-top" cover slides up and out of the way which allows for quick access to drum pumps and funnels
- 100% polyethylene construction will not rust or corrode
- Safe handling, can be moved by forklift under the "shoulder" area or wheeled with optional dolly (dolly sold separately)
- Meets SPCC and EPA Container Storage Regulation 40 CFR 264.175
- Helps meet Stormwater Management Regulations - NPDES, 40 CFR 122.26 (1999)
- Length: 36"
- Width: 36"
- Height: 66"
- Spill Capacity: 70 US gal.
- Load Bearing Capacity: 800 lbs.



Model No.	Mfg. No.	Description	Price /Each
SDS769	9640	Spill Containment Unit Without Drain	<b>1255.00</b>
SDS768	9641	Spill Containment Unit With Drain	<b>1315.00</b>

## DRUM ULTRA-HARD TOP PLUS® SPILL PALLETETS

- Provides a safe, convenient and effective place to store up to two 55-gallon drums
- Roll-top doors above and swing out doors below provide complete and easy access to the inside spill containment area
- Protect drums from the elements
- Low profile containment pallet positions drum-top funnels at a safe, convenient level to pour hazardous wastes
- Material: Polyethylene

### 2-DRUM ULTRA-HARD TOP PLUS' SPILL PALLETETS

- Lockable with a standard padlock, and can be safely lifted by forklift with drums in place
- Will not rust or corrode
- Easily accommodates rotary drum pumps and large conical funnels
- Meets SPCC, EPA Container Storage Regulation 40 CFR 264.175 and Uniform Fire Code Spill Containment Regulations

### 4-DRUM ULTRA-HARD TOP PLUS' SPILL PALLETETS

- Unique "dual enclosure" offers significant ergonomic and convenience benefits as drums can be easily accessed from either side
- Low profile containment pallet positions drum-tops at a safe, convenient level to pour wastes into funnels or to use drum pumps
- Forkliftable, lockable, all-polyethylene construction will not rust or corrode
- Helps meet new Stormwater Management Regulations - NPDES, 40 CFR 122.26
- Front doors swing wide allowing access to drums pre-loaded on wooden pallets



**SDL587**



Model No.	Mfg. No.	Description	Dimensions			Spill Cap US Gallons	Load Bearing Cap. lbs.	Sump Cap. US Gallons	Weight lbs.	Price /Each
			L"	x W"	x H"					
SDL587	09612	2-Drum Spill Pallet Without Drain	67.2	x 41.25	x 74	66	4500	66	260	<b>3829.00</b>
SDL588	09613	2-Drum Spill Pallet With Drain	67.2	x 41.25	x 74	66	4500	66	260	<b>3875.00</b>
SDL589	09636	4-Drum Spill Pallet Without Drain	66	x 64	x 84	75	9000	75	440	<b>5815.00</b>
SDL590	09637	4-Drum Spill Pallet With Drain	66	x 64	x 84	75	9000	75	440	<b>5919.00</b>





## POLY-SAFETYPACK®

### SAFE, SECURE TWO-DRUM STORAGE!

- Tough, indoor or outdoor performer protects two 55 US gallon drums
- Hinged, gull-wing covers provides convenient, safe access for decanting and removal of drums
- 100% polyethylene has excellent resistance to chemicals as well as weather
- Security locks are included to secure the covers and contents
- Removable polyethylene grating 48" x 24" x 2"
- Translucent yellow sidewalls allow visual leak detection without removing lids
- Easily handles by forklift or pallet jack from two sides
- For easier mobility, use the Poly-Safety Pack® caster frame assembly SE565
- **Exterior Dimensions:** 60 1/2" L x 37 1/4" W x 45 3/4" H
- **Interior Dimensions:** 52" L x 26 1/2" W x 37" H
- 130 US gallon sump capacity

### POLY-SAFETY PACK® PLUS

- Inside height of 54 1/4"
- Allows the lids to be closed with the pumps in place
- Optional drain
- **Exterior dimensions:** 60 1/4" L x 34 1/2" W x 64" H
- **Interior dimensions:** 51 1/4" L x 26 1/4" W x 54 1/4" H
- 264 US gallon sump capacity



Model No.	Mfg. No.	Description	Wt. lbs.	Price /Each
SB757	2038-YE	Poly-Safety Pack®	103	2105.00
SR415	2038-YE-D	Poly-Safety Pack® w/Drain	103	2149.00
SE565	2200-BK	Poly-Safety Pack® Caster Frame	37	1199.00
SR416	2077-YE	Poly-Safety Pack® Plus	137	2459.00
SR417	2077-YE-D	Poly-Safety Pack® Plus w/Drain	137	2485.00

## HAZARD HUT®

### THE SOLUTION TO YOUR INDOOR STORAGE PROBLEM IS OUTDOOR CONTAINMENT!

- One-piece molded 100% polyethylene construction so there are no joints or seams to leak
- Molded-in side vents reduce fumes and condensation inside
- Removable interior decking makes it easy to clean
- 72 US gallon sump capacity ensures leak and spill containment
- Double doors provide easy access for up to four 55 US gallon drums
- Double-wall construction and heavy-duty hinges and lock latches keep contents secure
- Four-way forklift entry design
- Loading the Hazard Hut® is easy with the Hazard Hut® Poly Ramp
- Door Opening: 41 1/2" W x 48 1/2" D



### HAZARD HUT® POLY-RAMP

- Integrally moulded handles
- 5" polyolefin wheels
- 10° slope allows for easy loading
- Ribbed, non-skid surface
- 100% polyethylene



Model No.	Mfg. No.	Description	Exterior Dimensions			Load Bearing Cap. lbs.	Wt. lbs.	Price /Each		
			L"	x	W"				x	H"
SB758	4000-YE	Hazard Hut®	63 1/2	x	68	x	72 1/2	4000	269	4735.00
SB759	4001-BK	Poly-Ramp	118	x	31	x	15 1/4	1000	154	1799.00



## JOB HUT™

### OUTDOOR STORAGE HAS NEVER BEEN SO PRACTICAL... OR SO AFFORDABLE!

- Constructed of tough 100% polyethylene
- Won't rust or corrode
- Molded-in vents to reduce fumes and condensation inside
- Heavy-duty double-walled doors and lock keep contents secure
- Tie down feature for secure anchorage
- Eight 55 US gallon drums capacity
- Load bearing capacity of 8000 lbs.
- 72 US gallon maximum sump capacity (to top of grate) that eliminates the risk of spills or leaks
- Structural foam grates remove for easy cleaning
- Low profile design allows for easy access
- Forkliftable from all sides for effortless handling
- Job Hut™ meets EPA regulation 40 CFR 264.175, is not fire rated
- Multi-purpose work ramp attaches to the Job Hut™ in seconds



### MULTI-PURPOSE WORK RAMP

#### Lightweight and easy to handle!

- Featuring a 10° non-skid slope facilitates loading drums quickly and safely
- Load bearing capacity of 1000 lbs.



Model No.	Mfg. No.	Description	Dimensions			Wt. lbs.	Price /Each		
			L"	x	W"			x	H"
SE563	4010-YE	Job Hut™	90	x	61 1/2	x	94 (ext.)	440	9115.00
			70	x	51	x	82 (int.)		
SAQ187	5111-BK	Ramp	25 1/2	x	46	x	6 1/4	30	485.00

# SPILL CONTROL MANAGEMENT SUPPLIES

## IBC 2000I™

### INTERMEDIATE BULK CONTAINMENT MADE EASY!

- Fits more than 99% of all IBC dispensing units
- Large sump capacity of 385 US gallons, exceeding EPA 40 CFR 264.175 regulations
- Equipped with an integrated 5-gallon pail holder for quick and easy dispensing
- 1-piece, lightweight, 100% polyethylene
- Forkliftable and nestable
- Will not rust or corrode or have adverse reactions with chemicals
- **Exterior Dimensions:** 73" L x 80.5" W x 29.5" H
- **Pedestal Dimensions:** 56.75" L x 56.75" W x 29.5" H
- Optional drain available



IBC dispensing units not included



Model No.	Mfg. No.	Description	Wt. lbs.	Price /Each
SR446	5469-YE	IBC 2000I™	262	3849.00
SR685	5469-YE-D	IBC 2000I™ w/Drain	262	3909.00

## IBC SPACE-SAVER™

- Floor space efficient alternative for storing, dispensing and containing IBC totes
- Solid 100% polyethylene construction
- Will not rust, corrode or have adverse reactions with chemicals
- Sump capacity: 330 US gallons
- Load capacity: 3000 lbs.
- **Exterior dimensions:** 57" L x 57" W x 48" H
- Optional drain



IBC dispensing unit not included



Model No.	Mfg. No.	Description	Wt. lbs.	Price /Each
SEI788	5460-YE	IBC Space-Saver™	240	3639.00
SEI789	5460-YE-D	IBC Space-Saver™ w/Drain	240	3709.00

## ULTRA-IBC SPILL PALLET PLUS®

- Low profile, 28" overall height allows safe and convenient IBC tank handling and dispensing
- All polyethylene construction offers excellent chemical resistance and will not rust or corrode
- Forkliftable
- Large 52" x 52" deck allows safe and convenient placement of IBC tanks
- Small 62" x 62" footprint requires minimal floor space
- 365-gallon sump capacity meets EPA Container Storage regulations
- Available with optional bucket shelf which catches leaks or spills during dispensing
- Dimensions: 62" L x 62" W x 28" H



IBC dispensing unit not included

Model No.	Mfg. No.	Description	Wt. lbs.	Price /Each
SAP075	1157	IBC Spill Pallet Plus	324	3399.00
SAP076	1158	IBC Spill Pallet Plus w/Drain	324	3455.00
SAP077	1160	Ultra-Bucket Shelf	10	295.00

## IBC CONTAINMENT PALLETS

- Fits more than 99% of all IBC units
- Features an integrated 5-gallon pail holder for quick and easy dispensing
- Most economical, one-piece, polyethylene IBC pallet on the market
- Forkliftable and nestable
- Removable grates for easy cleaning and sump access
- Regulations: EPA 40 CFR 264.175
- Dimensions: 73" L x 80-1/2" W x 29-1/2" H
- Sump Capacity: 385 Gallons
- Load Capacity: 3000 lbs.
- Weight: 176 lbs.



Model No.	Mfg. No.	Description	Price /Each
SDM233	5469-BD	IBC Containment Pallet	2995.00
SDM234	5469-BD-D	IBC Containment Pallet w/Drain	3059.00

## Control spills with confidence



# SPILL CONTROL MANAGEMENT SUPPLIES

## PROWLER POOL™

- Made of high-density polyethylene and a low-density coating
- Offers excellent resistance to the widest range of chemicals, acids, leaded and unleaded gasoline, diesel fuels and other hazardous materials
- Resistant to cold temperatures, as low as minus 60°F, as well as abrasion, punctures and ultraviolet rays
- Lightweight; half the weight of comparably sized PVC pools while offering double the strength



Model No.	Mfg. No.	Dimensions			Sump Cap.	Price
		Base"	x	Top" x	US Gallons	/Each
SAQ189	5920-YE	28 Dia.	x	18 Dia. x	20	225.00
SAQ190	5966-YE	48 Dia.	x	36 Dia. x	66	335.00
SAQ191	5900-YE	48 Dia.	x	32 Dia. x	100	365.00
SAQ192	5950-YE	60 Dia.	x	44 Dia. x	150	395.00

## ECONO SPILL SHELLS™

- 5" sidewall allows for more sump space
- Diamond center pulls spills away from the drums
- Drip parameter retains liquids for cleaner sump area



Model No.	Mfg. No.	Dimensions			Sump Cap.	Price
		L"	x	W" x	US Gallons	/Each
SEC889	5002-BK	45	x	35 x 5	21.5	415.00
SEC890	5004-BK	51	x	47 x 5	36	489.00

## DRIPILLOW BERMS™ & OFF-ROAD DRIPILLOW BERMS™

- Ideal for outdoor leaks and spills under vehicles, hydraulic lines or equipment
- Designed as durable, portable drip-pan
- Stable weighted base will not flip, tip or splash in windy conditions
- Compatible with all fuels and hydrocarbons
- Folds for easy carrying and storage
- **Standard** includes grounding strap, weighted base and UV resistant removable pad
- **Off-Road** includes corner grommets and an additional weighted base allowing for easy staking and security in high-wind and rugged terrain applications
- Available in OD green upon request
- Available in Standard and Off-Road versions
- Refill pads available, sold as a case of 5



Model No.	Mfg. No.	Description	Exterior Dim.			Sump Cap.	Weight	Price
			L"	x	W" x	US Gallons	lbs.	/Each
<b>STANDARD DRIPILLOW BERMS™</b>								
SAH552	5650-YE	Small w/Pad	22	x	22 x 1	1	7	159.00
SAH553	5660-YE	Medium w/Pad	24	x	36 x 1	2	8	185.00
SAH554	5670-YE	Large w/Pad	24	x	54 x 1	3	9	245.00
SAH555	5680-YE	X-Large w/Pad	38	x	42 x 1	4	9	315.00
<b>OFF-ROAD DRIPILLOW BERMS™</b>								
SEI802	5690-YE	Small w/Pad	36	x	36 x 1	4	12	405.00
SEI803	5691-YE	Medium w/Pad	36	x	72 x 1	10	15	539.00
SEI804	5692-YE	Large w/Pad	48	x	48 x 1	8	19	509.00
SEI805	5693-YE	X-Large w/Pad	48	x	60 x 1	12	21	559.00

### REFILL PADS

Model No.	Mfg. No.	Description	Price /Each
<b>STANDARD</b>			
SAH556	5655-WH	Small	245.00
SAH557	5665-WH	Medium	279.00
SAH558	5675-WH	Large	385.00
SAH559	5685-WH	X-Large	515.00

### Priced per Case

Model No.	Mfg. No.	Description	Price /Each
<b>OFF-ROAD</b>			
SEI806	5690-WH	Small	585.00
SEI807	5691-WH	Medium	1139.00
SEI808	5692-WH	Large	985.00
SEI809	5693-WH	X-Large	1185.00

## DUCK PONDS MINI-BERM CONTAINMENT

- For quick response to leaking machines, preventative maintenance and emergency drips, ponds are the perfect quick-grab that is rugged and ideal for small areas for rapid deployment
- Perfect for where storage space is limited
- Can hold various drum sizes with ease and affordability
- Provides both reliable and reusable secondary containment for oils, fluids and gasoline
- Easy to maneuver and can withstand extreme cold temperatures to -55°F/-48°C
- Width: 2'
- Length: 2'
- Regulations: EPA, SPCC, and NPDES



Model No.	Mfg. No.	Spill Cap US Gallons	Height"	Weight lbs.	Price /Each
SEI178	5622-YE	10	4	7	375.00
SEI790*	5622-YE-F	15	6	5	379.00

\*Features a safety-secure strap for easy folding and compact storage

## FOAM WALL ULTRA-CONTAINMENT BERMS®

- Low profile design is perfect for equipment maintenance and portable drum containment
- Captures nuisance leaks and spill from vehicles, oily equipment, tanks and drums
- Soft foam sidewall easily compresses for convenient loading and off-loading
- No set-up required, simply unfold for quick deployment
- Folded units require minimum storage space
- 24-mil PVC withstands the rigors of industrial and construction applications
- Built-in handles help with transport and placement
- Height: 4"



Model No.	Mfg. No.	Spill Cap US Gallon	Dimensions		Weight lbs.	Price /Each	
			L'	x	W'		
SDN663	8460	59	6	x	4	21	1125.00
SDN664	8461	159	8	x	8	40	1139.00
SDN665	8462	478	16	x	12	74	3159.00
SDN666	8463	1047	35	x	12	138	6915.00
SDN667	8464	1496	50	x	12	187	5835.00



# SPILL CONTROL MANAGEMENT SUPPLIES

## STINGER SNAP-UP BERM

- Ideal for large scale spill containment
- Flexible sidewalls and easy-to-assemble design allows for immediate response to industrial, government, construction, transportation and emergency response situations
- Designed for quick set up and compact fold-up, storage and transport
- Features excellent rip, tear and puncture resistance for the most demanding application or terrain
- Sidewalls fold down for easy drive-in and drive-out
- Chemical and abuse resistance
- Custom colours and sizes available



Model No.	Mfg. No.	Exterior Dimensions					Sump Cap.	Wt.	Price
		L'	x	W'	x	H'	US Gallons	lbs.	/Each
SAF806	48-461-BK-SU	4	x	6	x	1	179	28	1549.00
SAF807	48-661-BK-SU	6	x	6	x	1	269	37	1885.00
SAF808	48-10101-BK-SU	10	x	10	x	1	748	60	3105.00
SAF809	48-10261-BK-SU	10	x	26	x	1	1944	122	5109.00
SAF810	48-12361-BK-SU	12	x	36	x	1	3231	165	7005.00

Tracmats™ and ground pads are available in any size/dimensions to match any style berm.

## ECONOMY L-BRACKET BERMS

- Engineered to be rugged, yet features quick and simple set up
- First-class chemical, rip, tear and puncture resistance
- Easy, fast setup at an economical price
- Compact storage and transport
- Tested welds ensure maximum performance



Model No.	Mfg. No.	Dimensions					Sump Cap.	Wt.	Price
		L'	x	W'	x	H'	gal.	lbs.	/Each
SDM235	BD-44-AL-L	4	x	4	x	1	119	20	619.00
SDM236	BD-55-AL-L	5	x	5	x	1	187	27	665.00
SDM237	BD-68-AL-L	8	x	6	x	1	359	49	809.00
SDM238	BD-1010-AL-L	10	x	10	x	1	748	52	1035.00
SDM239	BD-1020-AL-L	10	x	20	x	1	1496	78	1559.00
SDM240	BD-1030-AL-L	10	x	30	x	1	2244	155	1939.00
SDM241	BD-1040-AL-L	10	x	40	x	1	2992	173	2715.00
SDM242	BD-1050-AL-L	10	x	50	x	1	3740	195	3325.00
SDM243	BD-10601-AL-L	10	x	60	x	1	4488	246	3879.00

## RIGID-LOCK QUICKBERM®

- Safe, drive-in spill containment for drums, IBC totes, and tanks
- Single-piece construction with patented Rigid-Lock wall support system integral to berm provides unobstructed work space
- Quick and easy set up, no assembly required
- Durable modified PVC coated fabric withstands long-term UV exposure
- Withstands a broad range of chemicals including petroleum, oils, grease, and most acids
- Walls include a 1" fray-resistant finished hem along the top rim for added wall strength and integrity
- Each support includes a black high-strength engineered nylon hub with integrated hole for anchoring under high wind conditions (anchors not included)
- Portable design folds down quickly for storage and transport
- Helps comply with EPA for containment and spill preventions (SPCC)



Model No.	Mfg. No.	Spill Cap US Gallons	Dimensions				Weight	Price	
			L'	x	W'	x	H"	lbs.	/Each
SDN615	28512	175	6	x	4	x	12	28	1253.00
SDN616	28514	235	8	x	4	x	12	34	1449.00
SDN617	28516	355	8	x	6	x	12	38	2059.00
SDN618	28518	475	8	x	8	x	12	45	2306.00
SDN619	28519	745	10	x	10	x	12	60	2767.00

## STINGER YELLOW JACKET™

LIGHTWEIGHT, PORTABLE PALLET CAN BE CARRIED ANYWHERE TO PREVENT SPILLS FROM OCCURRING!

- Made of vinyl coated polyester
- Chemical-resistant, stands up to corrosive battery acid, and is a great addition to any spill kit
- Unique snap-up support strips create a sturdy sidewall when unit is opened
- Optional removable polyethylene grates for easy access to the sump (SE553)
- Grates helps you comply with EPA 40 CFR 264.175 when used with a pallet



Model No.	Mfg. No.	Dimensions				Sump Cap.	Wt.	Price	
		L"	x	W"	x	H"	US Gallons	lbs.	/Each
SE472	57-448-YE-SU	48	x	48	x	8	80	15	1039.00
SE473	57-468-YE-SU	48	x	72	x	8	120	18	1139.00
SE474	57-488-YE-SU	48	x	96	x	8	160	28	1265.00
SE475	57-888-YE-SU	96	x	96	x	8	320	31	1805.00
SE476	57-8108-YE-SU	96	x	120	x	8	400	38	1979.00

### REMOVABLE GRATE

SE553	7006-BK	48	x	23	x	2	-	18	135.00
-------	---------	----	---	----	---	---	---	----	--------

Note: Dimensions given are sump dimensions

## HALO™ WALL MOUNT EYEWASH STATIONS

- Features antimicrobial protection, integral strainers, and rugged safety-yellow powder coating for easy visual identification in an emergency
- Aquaduct™ self-draining design eliminates bacteria growth from standing fluid
- Eye/face wash models provide industry leading 85% facial coverage
- Activate by push handle or by lifting dust cover
- Optional see-through dust cover (shown) makes inspection simple and keeps device free of debris and ready for use
- Stainless steel models are ideal for corrosive, high abuse environments
- Wheelchair accessible
- Arrives fully assembled
- ULC certified to ANSI standard Z358.1

### IMPORTANT:

Regulations require tepid water (18-37°C). See page 508 for water tempering devices



SEB798



Model No.	Mfg. No.	Bowl	Dust Cover Included	Price /Each
<b>EYEWASHES</b>				
SEB793	S19224EW	Plastic	-	445.00
SEB794	S19224PDC	Plastic	Plastic	635.00
SEB795	S19224B	Stainless Steel	-	582.00
SEB796	S19224DC	Stainless Steel	Stainless Steel	950.00
<b>EYE/FACE WASHES</b>				
SEB797	S19224FW	Plastic	-	541.00
SEB798	S19224PDCFW	Plastic	Plastic	755.00
SEB799	S19224T	Stainless Steel	-	696.00
SEB800	S19224CFW	Stainless Steel	Stainless Steel	1064.00

## WALL-MOUNT AXION® MSR EYE/FACE WASH STATIONS

- Provides a Zero Vertical Velocity™ stream
- Wall mounts with an aluminum bracket
- 11" diameter bowl
- Mesh strainer collects debris
- Durable ball valve with stainless steel stem
- Certified by CSA to meet the ANSI standard Z358.1



SEB239



SEB240



Model No.	Mfg. No.	Description	Price /Each
<b>EYE/FACE WASHES</b>			
SEB239	7260B-7270B	ABS Plastic Bowl	657.00
SEB240	7360B-7460B	Stainless Steel Bowl	852.00
<b>ACCESSORIES</b>			
SEB264	9102	Stainless Steel Dust Cover	594.00
SEI814	9201EW	Thermostatic Mixing Valve	878.00

## SUPPLY PIPE-MOUNTED EYE/FACE WASH

- High visibility ABS plastic Yello-bowl®
- 1/2" chrome-plated bronze stay-open valve with stainless steel stem
- Stainless steel push plate with easily identifiable actuation graphic
- Third party certified to meet the ANSI Z358.1 Standard
- **SAK650** comes with cover assembly to keep airborne particles out of bowl and eye/face wash heads
- ABS, 8 GPM eye/face wash heads; **SAK649** comes with float off dust caps secured with stainless steel bead chain
- Coverage Area: Eye/Face
- Installation Type: Wall-Mount
- Bowl Material: Plastic
- Size: 10.8" Dia. Bowl
- Weight: 6 lbs.



SAK650



Model No.	Mfg. No.	Description	Price /Each
SAK649	01035401	ABS Plastic Bowl	750.00
SAK650	01035515PBC	ABS Plastic Bowl w/Cover	1601.00

## WALL-MOUNT AXION® MSR EYE/FACE WASH STATIONS

- Revolutionary inverted flow sweeps contaminants away from the vulnerable nasal cavity
- Provides a zero vertical velocity stream for enhanced comfort, stability, and effectiveness
- No bowl, floor drain recommended
- Wall mounts with an ABS plastic wall bracket
- Durable ball valve with stainless steel stem
- Certified by CSA to meet the ANSI standard Z358.1

Model No. SEB241  
Mfg. No. 7324  
Price/Each \$721.00



# EMERGENCY SHOWER & EYEWASH

## HALO™ PEDESTAL MOUNT EYEWASH STATIONS

- Pedestal safety eyewash fixtures are ideal where wall mount is not practical, and allow placement closest to point-of-need
- Features antimicrobial protection, integral strainers, and rugged powder coat safety-yellow coating for easy visual identification in an emergency
- Aquaduct™ self-draining design eliminates bacteria growth from standing fluid
- Eye/face wash models provides industry leading 85% facial coverage
- Activate by push handle or by lifting dust cover
- Optional see-through dust cover (shown) makes inspection simple and keeps device free of debris and ready for use
- Stainless steel models are ideal for corrosive, high abuse environments
- Arrives fully assembled
- Wheelchair accessible
- ULC certified to ANSI standard Z358.1

**IMPORTANT:** Regulations require tepid water (18-37°C). See page 508 for water tempering devices

Model No.	Mfg. No.	Bowl	Dust Cover Included	Price /Each
<b>EYEWASH</b>				
SEB785	S19214EW	Plastic	-	562.00
SEB786	S19214PDC	Plastic	Plastic	744.00
SEB787	S19214B	Stainless Steel	-	720.00
SEB788	S19214DC	Stainless Steel	Stainless Steel	1086.00
<b>EYE/FACE WASH</b>				
SEB789	S19214FW	Plastic	-	677.00
SEB790	S19214PDCFW	Plastic	Plastic	860.00
SEB791	S19214Y	Stainless Steel	-	834.00
SEB792	S19214DCFW	Stainless Steel	Stainless Steel	1202.00



**Halo**  
EYE/FACEWASH

## AXION® MSR PEDESTAL EYE/FACE WASH STATIONS

- Revolutionary inverted flow sweeps contaminants away from the vulnerable nasal cavity
- Provides a Zero Vertical Velocity™ stream for enhanced comfort, stability and effectiveness
- 11" diameter bowl
- Galvanized stanchion for long life
- Mesh strainer collects debris
- Durable ball valve with stainless steel stem
- Certified by CSA to meet the ANSI standard Z358.1



Model No.	Mfg. No.	Description	Price /Each
<b>EYE/FACE WASH</b>			
SEB242	7261-7271	ABS Plastic Bowl	965.00
SEB243	7361-7461	Stainless Steel Bowl	1192.00
SEB244	7777	All Stainless Steel Components	3952.00
<b>ACCESSORIES</b>			
SEB264	9102	Stainless Steel Dust Cover	594.00
SEI814	9201EW	Thermostatic Mixing Valve	878.00

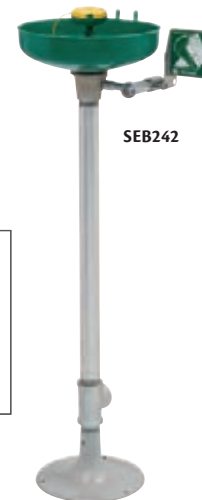

## PEDESTAL MOUNT EYE/FACE WASH

- Pedestal is schedule 80 hot-dipped galvanized piping
- High visibility ABS Yello-bowl®
- Supply with 1/2" chrome-plated bronze stay open valve with stainless steel stem
- Stainless steel push plate with easily identifiable actuation graphic
- Third party certified to meet the ANSI Z358.1 Standard
- **SAK652** comes with cover assembly to keep airborne particles out of bowl and eye/face wash heads
- ABS, 8 GPM eye/face wash heads; **SAK651** comes with float off dust caps secured with stainless steel bead chain
- Coverage Area: Eye/Face
- Installation Type: Pedestal
- Bowl Material: Plastic
- Size: 10.8" Dia. Bowl

Model No.	Mfg. No.	Description	Price /Each
SAK651	01035401	ABS Plastic Bowl	1050.00
SAK652	01035415PBC	ABS Plastic Bowl w/Cover	2249.00



**Encon**  
SAFETY PRODUCTS



## HALO™ COMBINATION EMERGENCY SHOWER & EYEWASH STATIONS

- Combine Halo™ eyewash technology with SpinTec™ shower features for high performance safety installations
- SpinTec™ showers yield superior fluid distribution • Durable ABS plastic showerhead
- Compact profile means less in-plant damage
- Features antimicrobial protection, integral strainers, and rugged safety-yellow powder coating for easy visual identification in an emergency
- Aquaduct™ self-draining design eliminates bacteria growth from standing fluid
- Eye/face wash models provides industry leading 85% facial coverage
- Activate by push handle or by lifting dust cover
- Eyewash models feature unique flip open dust caps
- Optional see-through dust cover (shown) makes inspection simple and keeps device free of debris and ready for use
- Stainless steel models are ideal for corrosive, high abuse environments
- Eyewash subsection fully assembled
- ULC certified to ANSI standard Z358.1

**IMPORTANT:** Regulations require tepid water (18-37°C).  
See page 508 for water tempering devices



Model No.	Mfg. No.	Bowl	Dust Cover Included	Special Features	Price /Each
<b>EYEWASH</b>					
SEB801	S19314EW	Plastic	-	-	1435.00
SEB802	S19314P	Plastic	-	Drench Hose	1784.00
SEB803	S19314PDC	Plastic	Plastic	-	1560.00
SEB804	S19314SB	Stainless Steel	-	-	1533.00
SEB805	S19314DC	Stainless Steel	Stainless Steel	-	1902.00
<b>EYE/FACE WASH</b>					
SEB806	S19314FW	Plastic	-	-	1555.00
SEB807	S19314PDCFW	Plastic	Plastic	-	1674.00
SEB808	S19314SBFW	Stainless Steel	-	-	1719.00
SEB810	S19314DCFW	Stainless Steel	Stainless Steel	-	2017.00
SEB813	S19314BF	Stainless Steel	-	Wheelchair Accessible	1781.00

## COMBINATION EMERGENCY SHOWER & EYE/FACE WASH STATIONS

- Hydrodynamic shower design produces equal flow distribution
- Revolutionary inverted flow sweeps contaminants away from the vulnerable nasal cavity
- Provides a Zero Vertical Velocity™ stream for enhanced comfort, stability and effectiveness
- 11" diameter bowl
- Galvanized stanchion for long life
- Mesh strainer collects debris
- Durable ball valve with stainless steel stem
- Certified by CSA to meet the ANSI standard Z358.1



Model No.	Mfg. No.	Bowl	Shower Head	Special Features	Price /Each
SEB257	8320-8325	Plastic	Plastic	-	1982.00
SEB258	8300-8309	Stainless Steel	Plastic	-	1671.00
SEB259	8330	Stainless Steel	Stainless Steel	Corrosion Resistant Stainless Steel Piping	5329.00
SEB260	8336	Plastic	Plastic	Green Epoxy Coating	4481.00

## COMBINATION SHOWER EYE/FACE WASH

- High visibility ABS Yello-bowl®
- Schedule 80 hot dip galvanized piping with chrome-plated bronze stay open valves
- High visibility ABS plastic; self-adjusting 30 GPM showerhead
- Supply with 1 1/4" NPT connection
- Shipped partially assembled for easy and quick installation
- Third party certified to the ANSI Z358.1 Standard
- **SAK660** comes with cover assembly to keep airborne particles out of bowl and eye/face wash heads
- **SAK659** comes with float off dust caps secured with stainless steel bead chain
- Coverage Area: Eye/Face|Full Body
- Installation Type: Unmounted
- Weight: 60 lbs.
- Bowl Material: Plastic



Model No.	Mfg. No.	Description	Price /Each
SAK659	1050216	ABS Plastic Bowl	2849.00
SAK660	01050266PBC	ABS Plastic Bowl w/Cover	4339.00



# EMERGENCY SHOWER & EYEWASH

## HORIZONTAL & VERTICAL SUPPLY EMERGENCY SHOWER STATIONS

- Designed for wall (horizontal) or ceiling (vertical) mounting
- SpinTec™ showerhead improves water distribution
- Activated with stainless steel pull rod and 1" IPS chrome-plated brass stay-open ball valve
- Constructed with 1" galvanized steel pipe, coated with safety-yellow Bradtech™ polyurethane to prevent corrosion
- Water supply: 1" IPS (female)
- Includes safety sign and inspection tag
- SEI certified to ANSI standard Z358.1



Model No.	Mfg. No.	Shower Head	Price /Each
<b>HORIZONTAL SUPPLY</b>			
SA414	S19-120	Plastic	465.00
SAK644	S19-120A	Stainless Steel	595.00
<b>VERTICAL SUPPLY</b>			
SA416	S19-130	Plastic	435.00
SAK645	S19-130A	Stainless Steel	567.00

## FLUSH-MOUNTED EMERGENCY SHOWER STATIONS W/ HORIZONTAL SUPPLY

- Integral flange mounts flush with ceiling
- Concealed pipe and fittings
- Exceed minimum water flow of 20 GPM at 30 PSI
- Universal identification sign and inspection tag included
- SEI certified to ANSI standard Z358.1

Model No. SAR320  
Mfg. No. S19-120FM  
Price/Each \$809.00



## WALL MOUNT ADA DRENCH SHOWER

- AXION® MSR ABS plastic drench shower head with flow control delivers dispersed flow for uniform drenching
- Reduced installation time due to pre-built valve assembly and units design allows for horizontal mount from any wall
- Solid construction from schedule 40 hot-dipped galvanized steel make for a durable long lasting product
- Certified by CSA to meet the ANSI Z358.1 Standard
- Coverage Area: Full Body
- Installation Type: Wall-Mount

Model No. SGC278  
Mfg. No. 8122HWC  
Price/Each \$992.00



## CORROSION RESISTANT COMBINATION EMERGENCY SHOWER & EYE/FACE WASH STATIONS

- SpinTec™ showerhead activated by a stainless steel pull rod and 1" IPS chrome-plated stay-open ball valve
- Impact-resistant plastic eyewash bowl with twin plastic spray heads
- Activated by a PVC push handle and 1/2" NPT stainless steel stay-open valve
- Fittings are all stainless steel
- 2" schedule 80 PVC pipe and floor flange withstands highly corrosive environments including chlorine
- SEI certified to ANSI standard Z358.1



Model No.	Mfg. No.	Description	Price /Each
SAK638	S19-310PVC	Combination Shower and Eye/Face Wash	2987.00
SR377	S53-063	Replacement Dust Caps (sold per each)	29.50

## HALO™ HEAT TRACE SHOWER & EYE/FACE WASH UNIT

- Durable, freeze-protected showers help keep employees safe in extreme, frigid environments
- Freeze protection valve ensures continual flow of water should power fail
- Impact-resistant plastic SpinTec™ showerhead improves water distribution
- Halo™ Eyewash technology delivers effective washdown coverage
- Eye/face wash bowl protected by dust cover
- Eye/face wash is operated by a large push handle that is easy to reach from any direction
- Universal identification sign and inspection tag
- Heat trace cable powered from 120 VAC protects until from freezing to -50° F (-46°C)
- Unit is encased in highly-visible yellow ABS removable plastic shell
- Shower valve operates quickly by a pull rod with a triangular handle
- Coverage Area: Full Body
- Installation Type: Pedestal
- Certification: ANSI Z358.1
- Colour: Yellow
- Electrical Rating: General Area, Class I Division 2, Class I Division 1, Class II Division 1, Class II Division 2
- Minimum Environmental Temperature: -50° F (-46°C)
- Thread Type: 1-1/4" NPT
- Pipe Type: 1-1/4" Galvanized Steel
- Showerhead Diameter: 3.1" (78.7 mm)



Model No.	Mfg. No.	Water Supply Type	Price /Each
SGS358	S19-304GAT	Top	5775.00
SGS359	S19-304GAB	Bottom	5775.00

## HEAT-TRACED COMBINATION EMERGENCY SHOWER & EYE/FACE WASH STATION

- Hydrodynamic shower design produces equal flow distribution
- Features Axion® MSR components
- 120 VAC cable-heated
- Perfect for extreme weather conditions dropping down to -34°C
- Solid stainless steel pipe stanchion and galvanized fittings offer durability and corrosive-resistance
- Universal design allows for top or bottom water supply
- Unit is pre-built and fully water/pressure tested to reduce installation time
- Certified by CSA to meet the ANSI standard Z358.1

Model No. SEB261  
Mfg. No. 8317CTFP  
Price/Each \$8741.00



## FAUCET-MOUNT EYEWASH STATIONS

- Cost effective solution for applications with an existing faucet
- Now lead-free
- Cost effective product mounts on existing standard or goose-neck faucets
- Twin spray heads include a flow control and pop-off dust covers
- One second/one-step activation
- Use horizontal pin for normal hand or ware washing
- Pull button for eyewash
- Includes a safety sign and inspection tag
- Weight: 1 lb.
- SEI certified to ANSI standard Z358.1

**Model No. SAK621**  
**Mfg. No. S19-200B**  
**Price/Each \$155.00**

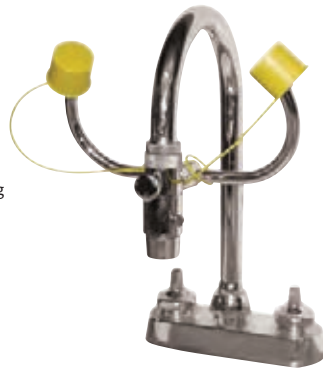

Faucet not included

## SWING-AWAY SINK-MOUNTED EYE/FACE WASH STATIONS

- Single-action swing-away eye/face wash stations can be mounted on sink to fit numerous locations
- Revolutionary inverted flow sweeps contaminants away from the vulnerable nasal cavity
- Provides a zero vertical velocity stream for enhanced comfort, stability, and effectiveness
- Dust cover protects the unit from debris when not in use
- Certified by CSA to meet ANSI standard Z358.1



SEB252



Model No.	Mfg. No.	Spray Head	Install	Price /Each
SEB252	7611	Plastic	Right or Left	1070.00
SDS755	7612	Stainless Steel	Right Only	957.00

## SWING-ACTIVATED EYEWASH STATIONS

- Swing-activated eye and eye/face wash stations mount to a counter or a wall
- Swing-over unit mounts to a counter only
- 90° swivel activates eyewash over sink to begin flow of water to cleanse eyes
- Stows neatly to side of sink when not in use to save space
- Twin spray heads include a flow control and pop-off dust covers
- Include a safety sign and inspection tag
- SEI certified to ANSI standard Z358.1



SEI776

Model No.	Mfg. No.	Description	Wt. lbs.	Price /Each
<b>EYEWASH</b>				
SEI776	519274C	Counter-Mounted, Swing Over	5	609.00
SEI777	519274HD	Counter-Mounted, Swing Down	5	892.00
SEI778	519274HW	Wall-Mounted, Swing Down	5	892.00
<b>EYE/FACE WASH</b>				
SEI779	519274E	Counter-Mounted, Swing Over	5	639.00
SEI780	519274JD	Counter-Mounted, Swing Down	5	946.00
SEI781	519274JW	Wall-Mounted, Swing Down	5	989.00

## PULL-DOWN EYE/FACE WASH STATIONS

- Pull-down eye/face wash can be mounted to a sink or wall
- Revolutionary inverted flow sweeps contaminants away from the vulnerable nasal cavity
- Provides a Zero Vertical Velocity™ stream for enhanced comfort, stability and effectiveness
- Rear mount design allows the sink to remain open to other uses
- Certified by CSA to meet ANSI standard Z358.1



SEB251



SGC274



Model No.	Mfg. No.	Description	Price /Each
SEB251	7610	Barrier-Free Wheelchair Accessible	1259.00
SGC274	7656WCSM	Recessed Wall Mount w/Containment Tray and Drain	4687.00

## SWING-ACTIVATED FAUCET/EYEWASH WITH WRISTBLADE FAUCET VALVES

- Combined faucet and eyewash saves space and fits into any work environment
- Halo delivers the most effective eye wash-down coverage and spray pattern
- Exceeds American National Standard Z358.1 Specifications
- The durable, ceramic valve shuts off flow to the faucet when the eyewash is activated
- Swing activation of eyewash moves faucet out of the way
- Water remains in the sink when either faucet or eyewash is activated
- Durable anti-rotational deck-mount units
- Controls hot and cold water supply to the faucet using independent wristblade control valves for each
- Installation Type: Sink Mount

**Model No. SHB554**  
**Mfg. No. S19-500W**  
**Price/Each \$1279.00**



## AXION® EYEPOD® EYEWASH

- Faucet-mounted eyewash in an attractive, low-cost, compact package
- Revolutionary inverted flow sweeps contaminants away from the vulnerable nasal cavity
- Sleek, smooth, stainless steel exterior blends with any décor
- Includes a variety of industry-standard faucet adapters, making installation a snap
- Easy to use and clean, the Axion® eyePOD® activates with just a quick rotation
- Features a built-in thermostatic control to guard against overheated water entering eyes
- Certified by CSA to meet ANSI standard Z358.1

**Model No. SEC658**  
**Mfg. No. 7620**  
**Price/Each \$597.00**





# EMERGENCY SHOWER & EYEWASH



## THERMOSTATIC MIXING VALVES

- Blend hot and cold water to a comfortable flushing temperature
- Reliable liquid-filled thermostat with a 10-year manufacturer's warranty
- Check stops on inlets
- Adjustable set point within temperature range
- Accurate temperature control to within  $\pm 3^\circ\text{F}$
- Built-in cold water bypass, assuring cold flow
- Easy installation and serviceability
- Positive shut-off of hot supply when cold supply is lost
- Dirt and lime resistant
- Dial thermometer
- Factory assembled and tested
- Universal mounting capability
- Rough bronze finish
- SEI certified to ANSI standard Z358.1
- Temperature adjustment are vandal resistant



SAI289

Integral strainer checkstops on inlet

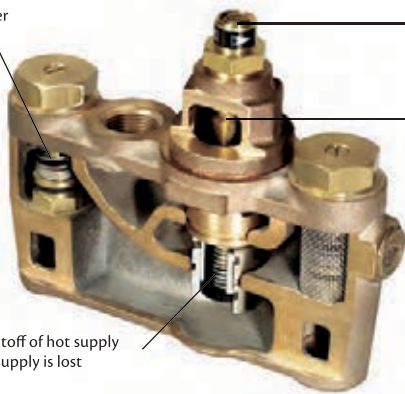

Set point adjustable within range by hex key set screw

Reliable, liquid-filled thermostat

Positive shutoff of hot supply when cold supply is lost



## THERMOSTATIC MIXING VALVES

- Designed to mix hot and cold water
- Flows from 10 - 78 GPM
- Modular brass design with internal check stops
- Wax-based thermostat technology for fast response time
- Oversized valve seals resist failures caused by foreign matter
- Proven highly reliable temperature control
- Features the lowest pressure drop in the industry
- Smallest TMV's in the industry, taking up less room under cabinetry
- Designed to work with hard and soft water quality
- Features cold water bypass and hot water shut off (in the event of cold water failure)
- CSA certified to ASSE 1071 and ANSI Z358.1



SEC205

SEI814



Model No.	Mfg. No.	Description	Accommodates	Price /Each
SAI289	S19-2000	7 GPM @ 30 PSI	Three eyewashes or one eye/face wash	1319.00
SAI294	S19-2100	19.5 GPM @ 30 PSI	One combination shower with eyewash or multiple eyewashes	2305.00
SAI299	S19-2200	54 GPM @ 30 PSI	Two combination showers with eyewashes or multiple eyewashes	3054.00

Model No.	Mfg. No.	Description	Ideal for	Price /Each
SEI814	9201EW	10 GPM @ 30PSI	Eyewash or Eye/Face Wash	878.00
SEB268*	TWBSEWE	12 GPM @ 30 PSI	Eyewash or Eye/Face Wash	4495.00
SEC205	9201E	31 GPM @ 30 PSI	Single Shower Unit	2311.00
SEC206	9202E	78 GPM @ 30 PSI	Multiple Shower Units	2917.00

\*Lead-free with full-flow bypass

## ON-SITE® GRAVITY-FED EYEWASH STATIONS

- Ideal for locations where a plumbed water source is not available
- High-visibility yellow, moulded pedestal and tank
- Hinged eyewash tray activates in one quick motion
- Stainless steel clamps secure the tank during transport
- Vandal-resistant unit: foreign objects cannot be introduced into tank because all openings are sealed once the tank is installed
- One of the lightest portable eyewashes on the market
- SEI certified to ANSI standard Z358.1
- Includes wall bracket (can also deck mount)

### ON-SITE® HEATER JACKETS

- Protects against freezing: down to  $-23.3^\circ\text{C}$  ( $-10^\circ\text{F}$ )
- Insulated heater jacket conceals a 121 W heater
- Secondary thermostat prevents overheating if primary thermostat fails
- Requires 120-volt AC line
- All UL-listed components

### ON-SITE® WASTE CARTS

- High-visibility yellow
- Captures used fluid, 56-gallon capacity
- Tapered sump, easy to drain



Model No.	Mfg. No.	Description	Wt. lbs.	Price /Each
SAK609	S19-921	Gravity-Fed Eyewash	23	555.00
SAK610	S19-921H	Gravity-Fed Eyewash w/Heater Jacket	25	3048.00
SAK611	S19-399	Waste Cart	28	637.00
SAK613	S19-865	Water Preservative, 8-oz. Bottle	0.5	9.61

## 9-GALLON PORTABLE EYEWASH STATIONS

- 9-gallon high-density green polyethylene tank made from FDA compliant materials
- Gravity fed to supply a continuous flow of water for 15 minutes at 0.4 GPM
- Easy-to-operate yellow activation arm protects eyewash spouts when not in use
- Wide-fill opening with threaded cap allows easy inspection, cleaning and filling
- Light design and mounting bracket (included) make relocation simple
- Optional sterile bacteriostatic additive, which permits storage of the water for up to three months
- Certified by CSA to meet ANSI standard Z358.1
- Freeze-protected and tempered version **SFV126** & **SFV127** ideal for remote, low traffic areas where protective measures are still needed and ambient temperatures could drop below freezing



Model No.	Mfg. No.	Description	Price /Each
SAR314	7501	Portable Gravity Eyewash Station	377.00
SFV126	7501T	Freeze-Protected and Tempered Gravity Eyewash Station, 120 V	4197.00
SFV127	7501T240	Freeze-Protected and Tempered Gravity Eyewash Station, 240 V	4197.00
SAR315	9082	Sterile Bacteriostatic Water Preservative, 8 oz., 4/case	115.00

## AQUARION® SELF-CONTAINED EYEWASH

- Yellow ABS cover for protection of fluid bags and internal cavity of the station
- Side windows for visual inspection of the fluid bags without removal of the cover
- Polycarbonate back plate with mounting slots
- Retracting tray to protect the nozzles from the environment
- Single pull down motion pierces seals in the hoses allowing the fluid to flow immediately from the attached nozzles
- Collects spent fluid and directs it to an integral drain port for future disposal
- Usage indicator tie breaks upon actuation showing that the unit has been used
- Non-injurious, dual stream of water at 0.4 gpm (1.5 lpm)
- Type: Gravity-Fed
- Standard(s) Met: ANSI Z358.1



SAK764

## PORTABLE PRESSURISED EYEWASH STATIONS

- Stainless steel tank
- Pressure fed to supply a continuous flow of water for 15 minutes at 0.4 GPM
- Safety features include an air pressure gauge, pressure relief valve, and a tire-type air fill valve
- Optional sterile bacteriostatic additive, which permits storage of the water for up to three months
- Certified by CSA to meet ANSI standard Z358.1
- All models compatible with body spray hose



SEB249

SFU811



## AQUARION



Model No.	Mfg. No.	Capacity	Description	Price /Each
SAK764	AQ100	7.4 gal.	Aquarion™ Self-Contained Eyewash	559.00
<b>CARTRIDGE</b>				
SAK765	AQ110	3.7 Gal (14 L) per cartridge	Sold per pair	917.00

Model No.	Mfg. No.	Description	Price /Each
SEB249	7601.37	37 gal. Station, With Body Spray Hose	11682.00
SAR315	9082	Sterile Bacteriostatic Water, Preservative 8 oz., 4/case	115.00
SEB250	9008	Transport Cart	644.00
SFU811	7603	15 gal. Eyewash Keg	3515.00
SEB263	8901B	Body Spray Hose	512.00

## PORTABLE PRESSURISED EYEWASH STATIONS

- Stainless steel pressure tanks include tire filler valve with 0-100 PSI air gauge, pressure relief valve to prevent over pressurization and built-in carry handles for easy transportation
- Eyewash assembly includes twin eyewash heads with a flow control and pop-off dust covers
- Eyewash activated by a large stainless steel push handle with stay-open ball valve
- 8' drench hose with hand-held squeeze valve
- Optional 4-wheel, stainless steel cart
- SEI Certified to ANSI standard Z358.1

### 10-GALLON UNIT:

- Eyewash flow: Minimum 15-minute water flow
- Drench hose flow: 3 1/2-minute water flow

### 15-GALLON UNIT:

- Eyewash flow: Minimum 22-minute water flow
- Drench hose flow: 5-minute water flow

### HEATED UNITS:

- 510 watt heater
- Maintain average water temperature at 75°F (24°C)
- Secondary thermostat prevents overheating
- UL-listed components
- Plug into 120-volt AC line, GFCI recommended



Model No.	Mfg. No.	Description	Wt. lbs.	Price /Each
SAK628	S19-690	10 Gallons	30	2456.00
SAK629*	S19-690H	10 Gallons w/Heater Jacket	31	3975.00
SAK630	S19-788	15 Gallons	35	2733.00
SAK631*	S19-788H	15 Gallons w/Heater Jacket	36	4418.00
SAK632	S19-690A	Transport Cart	12	467.00
SAK613	S19-865	Water Preservative (4-8 oz)	3	9.61

\* Eyewash only, no drench hose



SAK628

SAK631

# EMERGENCY SHOWER & EYEWASH



## PURE FLOW 1000® EYEWASH STATIONS

- Sure-grip handle provides instant, simple activation
- Activation straps display expiration date
- Integral drain valve allows easy draining of reservoir after use
- Integral fluid reservoir captures waste fluid, eliminating potential safety hazards and simplifying fluid disposal
- Once activated, this device automatically displays a prominent, Warning Service Immediately, notice on the front of the unit; new fluid cartridges must be installed
- Requires two 3.8-gal. Eyesaline® fluid cartridges (sold separately)
- Device must be mounted on a wall or other suitable vertical surface
- Comes complete with product registration card, operating manual, metal hanging bracket for installation and an emergency eye wash sign
- SEI certified to meet ANSI standard Z358.1

**Honeywell**



SD552

Model No.	Mfg. No.	Description	Wt. lbs.	Price /Each
SD552	32-001000-0000	Eyewash station (English Instructions)	40	937.00
SAJ678	32-001000-0022	Eyewash station (French Instructions)	40	1093.00
SD553	32-001050-0000-H5	Fluid cartridges (2/pkg)	70	340.00

## PURE FLOW 1000® EYEWASH STATION - FLUID CARTRIDGES

- Size: 1120 oz.
- Weight: 70 lbs.
- Qty/Pkg.: 2

**Honeywell**



Model No. SD553  
Mfg. No. 32-001050-0000-H5  
Price/Each \$340.00

## FENDALL PORTA STREAM® FLUID DISPOSAL CARTS

- Portable, self-contained eyewash stations provide flexible, emergency eyewash capability in economical systems
- Lightweight, portable units don't require plumbing
- Heavy-duty, polyethylene, wheeled disposal cart
- Provides a convenient mean to transport waste solution to the nearest disposal site
- Can be used to catch fluid when testing plumbed emergency eyewash and showers that do not have drain
- Capacity: 23.5 gallons
- 3.94" diameter hole

Model No. SE137  
Mfg. No. 32-000511-0000  
Price/Each \$340.00

**Honeywell**



## FENDALL PORTA STREAM® I EYEWASH STATIONS

- Delivers 6 minutes of flushing fluid
- Easy installation with no plumbing required
- Single bracket mounting device included
- One-piece, molded construction with no moving parts
- Large hole simplifies refilling and cleaning
- Features simple, highly visible instructions on the unit itself
- Does not meet ANSI standard Z358.1 15-minute flushing requirement

**Honeywell**

Model No.	Mfg. No.	Description	Wt. lbs.	Price /Each
SA425	32-000100-0000	Fendall Porta Stream® I, Trilingual instructions	19	568.00
SA408	32-000509-0000	Eyesaline® concentrate, 70 oz. (For Porta Stream® I)	5	77.70
SA426	32-000102-0000	Replacement pull-strap, (Fits Porta Stream® I, II, III)	1	49.30

SA425



## FENDALL FLASH FLOOD® EYEWASH STATIONS

- Delivers 3 minutes of flushing fluid
- One-gallon sealed cartridges are easy to store and offer quick changes without mixing or measuring
- Easily wall or table mounted
- Features simple, highly visible instructions on the unit itself
- Does not meet ANSI standard Z358.1 15-minute flushing requirement

**Honeywell**

Model No.	Mfg. No.	Description	Wt. lbs.	Price /Each
SA419	32-000400-0000	Fendall Flash Flood® Eyewash Station (English Instructions)	14	298.00
SAM657	32-000400-0022	Fendall Flash Flood® Eyewash Station (French Instructions)	14	372.00
SA403	32-000401-0000	Eyesaline® 1 Gal. Refill (4/Pkg.) (English Instructions)	36	317.00
SAM658	32-000401-0022	Eyesaline® 1 Gal. Refill (4/Pkg.) (French Instructions)	36	379.00
SA420	32-000402-0000	Wire Rack for Cartridges	3	112.00

SA419





## FENDALL PORTA STREAM® II EYEWASH STATIONS

- Versatile portability and 15-minutes of uninterrupted flushing - without costly plumbing
- Simple installation and operation
- Features a nozzle strap that is easily removed to activate flushing, leaving hands free to hold eyelids open
- Can be easily and affordably placed near most workplace hazards with single bracket mounting device or transported with optional universal cart or universal stand
- Moulded handle accepts hanging bracket for vertical or horizontal surface installation
- Versatile flushing fluid options include Eyesaline® - a preserved, buffered, saline solution superior to tap water for emergency eye care, and water additive
- Large 16-gallon (60.5 L) capacity
- SEI certified to meet ANSI standard Z358.1

SEK529



## Honeywell

Model No.	Mfg. No.	Description	Wt. lbs.	Price /Each
SEK529	32-000200-0000	Trilingual Instructions	36	732.00
SA411	32-000513-0000	Eyesaline® Concentrate, 180 oz.	13	149.00
SA426	32-000102-0000	Replacement Pull-Strap, (Fits Porta Stream® I, II)	1	49.30

## SALINE EYEWASH BOTTLES

- Contains a buffered saline solution that is sterile and superior to tap water for emergency eye care
- Blow-Fill-Seal (BFS) bottle is tamper resistant, and maintains the sterility and integrity of the eyewash
- Easy to remove and open in emergency situations
- 1, 4, and 8 oz. bottles have user controlled delivery, delivering drops or an irrigating stream of solution, depending on the squeeze pressure applied to the bottle
- Trilingual instructions (English, French and Spanish)
- Does not meet ANSI standard Z358.1 15-minute flushing requirement



## Honeywell

Model No.	Mfg. No.	Cap. oz.	Price /Each
SEC467	32-000451-0000	1	4.92
SEC468	32-000452-0000	4	7.59
SEC469	32-000445-0000	8	11.40
SEC470	32-000454-0000	16	16.80
SEC471	32-000455-0000	32	22.70

## SALINE EYEWASH WALL STATIONS

- Holds bottle firmly in place while allowing easy access in an emergency
- Mounts to wall with provided screws
- Integral overhand protects bottles from dust and debris
- Durable plastic is easy to clean
- Simple, highly visible operating instructions are provided on each unit
- Bottle contains a buffered saline solution that is sterile and superior to tap water for emergency eye care
- Blow-Fill-Seal (BFS) bottle is tamper resistant, and maintains the sterility and integrity of the eyewash
- Delivers drops or an irrigating stream of solution, depending on the squeeze pressure applied to the bottle
- Trilingual instructions (English, French and Spanish)
- Does not meet ANSI standard Z358.1 15-minute flushing requirement



## Honeywell

Model No.	Mfg. No.	Station Type	Bottle Cap. oz.	Price /Each
SEC472	32-000460-0000	Single	16	53.00
SEC473	32-000465-0000	Double	16	79.00
SEC474	32-000461-0000	Single	32	59.90
SEC475	32-000462-0000	Double	32	89.00

Stay safe & work confidently with



# EMERGENCY SHOWER & EYEWASH

## SINGLE USE EYEWASH SOLUTION WITH EYE CUP

- Sterile irrigating solution washes the eye to help relieve irritation, discomfort, burning, stinging, and itching



Model No.	Mfg No.	Size	Price /Each
SGB154	FAEW016SU	16 oz./500 ml	20.30
SGB149	FAEW032SU	32 oz./1 L	34.90

## EYEWASH ADDITIVE CONCENTRATE

- Preserves 5 to 20 US Gal. (18.9 to 75.7 L) of potable water in a self-contained eyewash station by controlling the growth of bacteria, fungi, algae, and other impurities



Model No.	Mfg No.	Size	Price /Each
SGA904	FAEWC08	8 oz. (236 ml)	10.10

## EMPTY EYEWASH BOTTLES WITH EYE CUPS

- Empty bottles to hold irrigating solution in a complete eyewash station



SGA875



Model No.	Mfg No.	Description	Price /Each
SGA875	FAEWB16	16 oz./500 ml	12.50
SGA874	FAEWB32	32 oz./1 L	13.70
SGA867	FAEWC01	Eye Cup for 16 oz./500 ml and 32 oz./1 L bottle	7.42

## EYEWASH SOLUTION

- Sterile irrigating solution washes the eye to help relieve irritation, discomfort, burning, stinging, and itching



Model No.	Mfg No.	Size	Price /Each
SGB151	FAEW001	1 oz./30 ml	5.17
SGB147	FAEW004	4 oz./118 ml	7.09
SGB150	FAEW008	8 oz./250 ml	10.20
SGB153	FAEW016	16 oz./500 ml	17.60
SGB148	FAEW032	30.5 oz./1 L	31.00
SGB152	FAEW160	128 oz./4 L	73.70

## SINGLE USE EYEWASH STATIONS

- Complete with wall mounted panel, featuring a mirror, sterile irrigating solution and eye cups

SGA888



SGA887



Model No.	Mfg No.	Includes	Price /Each
SGA887	FAEWS6514F	SGA897 plus (1) 32 oz./1 L with eye cup SGB149	63.60
SGA889	FAEWS1416F	SGA894 plus (2) 32 oz./1 L with eye cup attach SGB149	97.00
SGA886	FAEWS1113F	SGA891 plus (1) 16 oz./500 ml with eye cup attach SGB154	57.50
SGA888	FAEWS1213F	SGA893 plus (2) 16 oz./500 ml with eye cup SGB154	79.10

## EYEWASH STATIONS

- Complete with wall mounted panel, featuring a mirror, sterile irrigating solution



SGA873



Model No.	Mfg No.	Includes	Price /Each
SGA870	FAEWS6517F	SGA898 plus one (1) bottle of isotonic solution SGB148 32 oz./1 L	59.60
SGA873	FAEWS1417F	SGA895 plus two (2) bottles of isotonic solution SGB148 32 oz./1 L	106.00
SGA883	FAEWS1714F	SGA896 plus one (1) bottle of isotonic solution SGB148 32 oz./1 L	64.20
SGA881	FAEWS1114F	SGA892 plus one (1) bottle of isotonic solution SGB153 16 oz./500 ml	52.90

## PANEL FOR EYEWASH STATIONS

- Wall mountable panels features a mirror and space to hold irrigating solution for a complete eyewash station

SGA894



SGA897



Model No.	Mfg No.	Holds	Size	Price /Each
SGA891	FAEWS1113	(1) 16 oz./500 ml bottle	11" x 13"	35.70
SGA892	FAEWS1114	(1) 16 oz./500 ml bottle	11" x 14"	33.60
SGA893	FAEWS1213	(2) 16 oz./500 ml bottles	12" x 13"	34.80
SGA894	FAEWS1416	(2) 32 oz./1 L bottles	14" x 16"	37.30
SGA895	FAEWS1417	(2) 32 oz./1 L bottles	14" x 17"	34.50
SGA896	FAEWS1714	(1) 32 oz./1 L bottle	14" x 17"	33.30
SGA897	FAEWS6514	(1) 32 oz./1 L bottle	6.5" x 14"	28.50

# EMERGENCY SHOWER & EYEWASH

## METAL EYEWASH STATIONS

- Wall mountable metal box complete with mirror and irrigation solution



## EYEWASH STATIONS WITH EMPTY EYEWASH BOTTLES

- Wall mountable panels features a mirror and empty bottle(s) to hold irrigating solution for a complete eyewash station



SGA880



Model No.	Mfg No.	Includes	Price /Each
SGA872	FAEWS9124F	SGA837 plus two (2) bottles of isotonic solution SGB148 32 oz./1 L	177.00

Model No.	Mfg No.	Includes	Price /Each
SGA877	FAEWS6517E	SGA898 plus one (1) empty eye wash bottle 32 oz./1 L	33.50
SGA884	FAEWS1417E	SGA895 plus two (2) empty eye wash bottles 32 oz./1 L	50.40
SGA880	FAEWS1714E	SGA895 plus one (1) empty eye wash bottles 32 oz./1 L	43.60
SGA879	FAEWS1114E	SGA892 plus one (1) empty eye wash bottle 16 oz./500 ml	35.90

## BIO MED WASH®

Bio Med Wash® is a sterile, heavy mist containing 100% Bio-Logic Aqua®, an all-natural, pH correct, pure tissue-culture grade of water. The application is helpful in removing particulate matter and crusted exudates from cuts and abrasions, and in removing irritating chemicals from skin and eyes

- Emergency first aid eye wash and irrigation
- All-natural bio-compatible hydrotherapy product replaces distilled, saline and tap water for most applications
- Washes dirt and other contaminants from cuts and lacerations
- Helps remove irritating chemicals from eyes and skin
- Three year shelf life

SGA749



SGA751



SGA754



SGA753



Model No.	Mfg No.	Description	Price /Each
<b>BIO MED WASH® SOLUTIONS</b>			
SGA751	FAEWSBM03	Bio Med wash solution 3 oz./90 ml	18.90
SGA749	FAEWSBM07	Bio Med wash solution 7 oz./210 ml	28.00
<b>COMPLETE BIO MED WASH® STATIONS</b>			
SGA753	FAEWSBMSWMF	Panel SGA748 plus (1) Bio Med wash bottle of 7 oz./210 ml	55.70
SGA755	FAEWSBMDWMF	Panel SGA748 plus (2) Bio Med wash bottle of 7 oz./210 ml	93.60
SGA754	FAEWSBMDWMF	Panel SGA748 with space for first aid kit and (2) Bio Med eye wash bottle 7 oz./210 ml	108.00
<b>PANEL ONLY AND HOLSTER FOR BIO MED WASH®</b>			
SGA748	FAEWSBMSWME	Panel only for (1) bottle of Bio Med wash 7 oz./210 ml, panel size: 5" x 14"	27.90
SGA747	FAEWSBMDWME	Panel only for (2) bottle of Bio Med wash 7 oz./210 ml, panel size: 12" x 14"	30.60
SGA752	FAEWSBMDWM	Biowash station with space for first aid, kit and (2) bottle of Bio Med wash 7 oz./210 ml	47.90
SGA745	FAEWSBMH3	Nylon holster for Bio Med wash 3 oz./90 ml bottle	8.71
SGA746	FAEWSBMH7	Nylon holster for Bio Med wash 7 oz./210 ml bottle	8.71
SGB201	FAEWSBTB	Plastic vehicle bracket	23.80



# EMERGENCY SHOWER & EYEWASH

## WALL-MOUNTED DRENCH HOSES

- Quick-access emergency eye and face spray features soft flow spray head for flooding large areas as well as eyes only
- Self-coiling highly visible yellow-coloured hose retracts for easy storage while allowing instant extension
- Water flows when handle on chrome-plated brass assembly is squeezed
- Wall bracket and protective spray head cover included
- Universal identification sign and inspection tag included



Model No.	Mfg. No.	Description	Price /Each
SEE320	S1944011CBC	12' Hose	669.00

## RETROFIT DUST COVERS

- Provides maximum protection from dust or other contaminants
- Hinged plastic cover
- Fits on Bradley eyewash bowls
- Weight: 5 lbs.



SED814



Model No.	Mfg. No.	Style	Price /Each
SAK620	S45-1964	Classic	241.00
SED814*	S90-390	Halo™	269.00

\*Halo™ dust covers are integral to the activation system.

## DUST COVERS

- Stainless steel dust cover assembly can be used with most 11" diameter stainless steel or plastic bowls
- Protects the unit against airborne contaminants



Model No.	Mfg. No.	Description	Price /Each
SEB264	9102	Dust Cover	594.00

## DRENCH SHOWER TESTERS

- Heavy-duty tester provides a convenient way to comply with ANSI specifications for weekly testing on all drench showers - without getting wet
- 84" long, watertight chemical resistant Tyvek® funnel with weighted bottom directs water to a drain or bucket
- 8" telescoping aluminum handle

Model No. SC338  
Mfg. No. S19-330ST  
Price/Each \$245.00

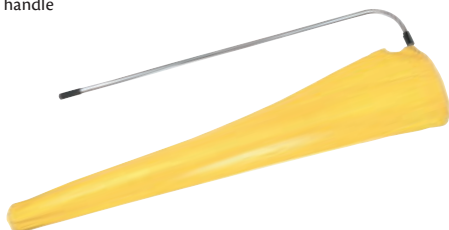

## HAND-HELD DRENCH HOSES

- Laboratory spray valve easily attaches to any Bradley drench shower or eyewash station
- Includes all necessary fittings and hanger for attaching hose to the units
- 8' highly visible yellow reinforced thermoplastic hose
- Handle stays open once it is squeezed
- Integral flow control assures safe, steady flow under varying water supply conditions



Model No.	Mfg. No.	Description	Wt. lbs.	Price /Each
SAK646	S19-430EH	For eyewash units	4	415.00
SAK647	S19-430SH	For drench showers	5	432.00

## EMERGENCY BODY HOSE WASH RETRO-KIT



- Dust cover allows for the spray head to stay protected from debris when not in use
  - Chrome plated brass stay-open squeeze lever valve with integral 6.25 gpm (23.7L) flow control
  - 8' (243.8 cm) swivel hose provides an extended coverage area to further optimize the irrigation process
  - Per ANSI, hand held drench hoses provide support for emergency showers and eyewash units, but shall not replace them
  - Length: 8'
  - Mounting Type: Hand-Held
- Model No. SGC298  
Mfg. No. 8901RFK  
Price/Each \$881.00



## EYEWASH TEST GAUGES

- Makes sure eyewash achieves a compliant pattern per ANSI standard Z358.1

Model No. SAQ294  
Mfg. No. 269-1444  
Price/Each \$42.50



## AXION® ADVANTAGE KITS

- Kits designed to upgrade existing emergency shower and eyewash equipment
- Includes an Axion® MSR eye/face wash or an Axion® MSR eye/face wash and showerhead, connecting hardware options, eyewash testing gauge, tape measure, and an ANSI compliance checklist



Model No.	Mfg. No.	Description	Price /Each
SEI816	AX13	Green ABS Plastic Eye/Face Wash	379.00
SEI817	AX13S	Stainless Steel Eye/Face Wash	459.00
SEI818	AX14	Green ABS Plastic Eye/Face Wash and Showerhead	610.00
SEI819	AX14S	Stainless Steel Eye/Face Wash and Showerhead	1038.00

# EMERGENCY SHOWER & EYEWASH

## EYEWASH STATION SIGNS

- Make sure your emergency eyewash and shower stations are well identified in accordance with ANSI standard Z358.1
- Conveniently available in several material choices to meet your needs:
  - 4-mil thick moisture resistant adhesive vinyl with permanent acrylic adhesive is perfect for light-duty applications
  - 0.055" thick semi-flexible plastic with UV inhibitors is ideal for indoor and sheltered outdoor applications
  - 0.040" thick aluminum with 2-mil UV polyester over-laminated film has superior abrasion and chemical resistance and is ideal for indoor and outdoor applications



	7" X 10"			10" X 14"		
	English Model No.	French Model No.	Price /Each	English Model No.	French Model No.	Price /Each
Adhesive Vinyl	SGL713	SGM475	10.10	SGL716	SGM478	15.15
Plastic	SGL714	SGM476	11.00	SGL717	SGM479	16.45
Aluminum	SGL715	SGM477	24.95	SGL718	SGM480	39.95

## EYEWASH STATION PROJECTION™ SIGNS



- .10" thick High-impact plastic
- 3D signs, projecting 45° from the wall, provide optimum viewing from front and sides
- 90D signs, projecting 90° from the wall, are viewed from either side
- Includes mounting holes and hardware

SAW431



SED963



Model No.	Description	Panel Size"	Overall Size"	Price /Each
<b>ENGLISH</b>				
SAW431	3D	6 x 5	6 x 8 1/2 x 4	32.50
SAW432	90D	8 x 8	8 x 8 x 11/2	34.50
<b>FRENCH</b>				
SED962	3D	6 x 5	6 x 8 1/2 x 4	32.50
SED963	90D	8 x 8	8 x 8 x 11/2	34.50

## EMERGENCY SHOWER STATION MATS F.I.T.™ KITS NO. 546

- Simple and compact emergency eyewash and shower mats kits
- Easy to assemble, no cutting or tools required
- Patented LockSafe™ connections simply snap together and zip apart
- Green is recommended for eyewash stations and red for shower stations
- Highly visible mats designate the location of emergency stations
- Created for high visibility per ANSI recommendations
- Elevates user above hazardous overflow
- Conforms to ANSI Z535.1 standard
- Available in two sizes
- 5/8" thick
- Contents: 6 tiles, 2 male corner ramps, 1 male ramp w/o tab, 2 male ramps w/tab, 2 female ramps



**1-YEAR WARRANTY**

Model No.	Dimensions" W' x L'	Colour	Price /Each
SEG993	27 x 30	Green w/Yellow Border	329.00
SEG994	27 x 30	Red w/Yellow Border	329.00
SEG995	27 x 42	Green w/Yellow Border	425.00
SEG996	27 x 42	Red w/Yellow Border	435.00

## PRIVACY CURTAINS

- Double-laminated, chemical-resistant Tyvek®
- Durable construction with top and bottom reinforcements
- Highly visible yellow color
- Stainless steel curtain rail and mounting brackets included
- Dimensions: 70" L x 145" W

Model No. SAQ295  
Mfg. No. S19-330  
Price/Each \$935.00

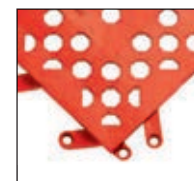
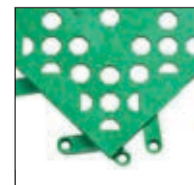
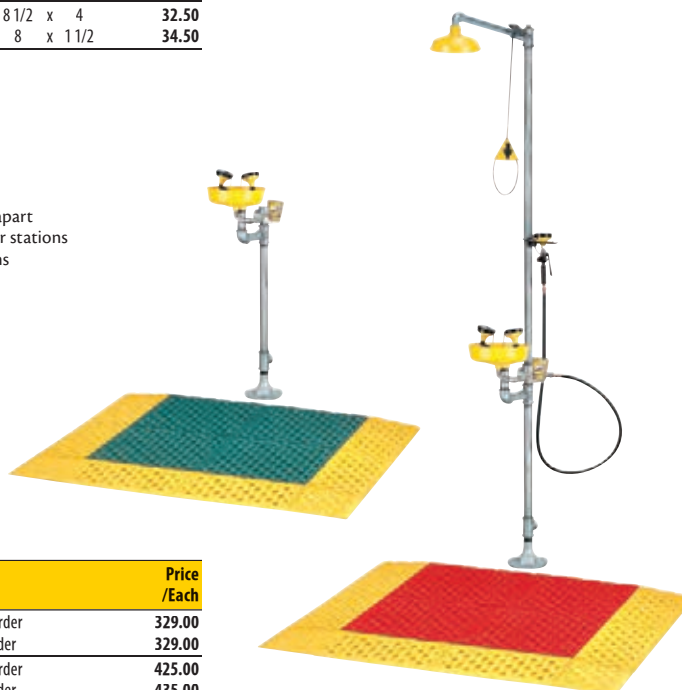

# FIRST AID & MEDICAL EQUIPMENT

## ZOLL® AED PLUS® DEFIBRILLATOR

- Only 50% of Sudden Cardiac Arrest (SCA) cases require a shock, but all rescues require high-quality CPR
- Zoll® Real CPR Help™ can measure rescuer compressions and guide rescuers to the Canadian Heart and Stroke Foundation's recommended 2" depth of compressions with voice and text prompts, in real-time, to "press harder" and follows with "good compressions" when the rescuer reaches the required depth
- Lower Cost of Ownership and more efficient lifetime maintenance with longer lasting batteries and longer lasting pads (both 5 years)
- Voice prompts, text prompts and metronome guide rescuers through a SCA event
- 7 year device warranty (5 years + 2 years after product registration)
- Configurable automatic self-tests evaluate device functionality every 1 to 7 days
- Weekly and monthly self tests by default – or customize as often as daily
- Available in fully automatic device, or semi-automatic device delivers shock with the simple press of a button
- IP55 rating for protection against dust and water
- Kits includes: Zoll® AED Plus®, Zoll® CPR-D-Padz® adult electrodes, sleeve of 10 lithium batteries, soft carry case, fast response rescue kit, manuals and orientation DVD



SAQ711

**ZOLL**

SAS088



SAQ712



Model No.	Mfg. No.	Description	Price /Each
<b>DEFIBRILLATORS</b>			
SDP593	2-2607-7107-0201-1060	Fully Automatic AED Plus® - English	2199.00
SDP594	2-2607-7107-0101-1260	Fully Automatic AED Plus® - French	2199.00
SAQ531	2-2600-0101-0201-1060	Semi Automatic AED Plus® - English	2199.00
SAQ532	2-2600-0101-0101-1260	Semi Automatic AED Plus® - French	2199.00
<b>ACCESSORIES</b>			
SAR368	8900-0807-01	CPR-D Accessory Kit	27.50
SAQ711	8900-0800-01	CPR-D Padz™ (5-Year Shelf Life)	239.00
SAS088	8900-0810-01	Pedi Padz II™ (2-Year Shelf Life)	155.00
SAQ712	8000-0807-01	Lithium Battery Pack (5-Year Shelf Life)	119.00

## AED WALL CABINET WITH ALARM

- Features a glass windowed door to allow visibility of your AED so that it is easy to find in an emergency situation

SHC001



SAX737



SHC006



SHC002



SHC007



Model No.	Mfg. No.	Description	Dimensions"	Interior Depth"	Price /Each
SHC001	CB2-L-CUSTOM	Standard	16 x 14-58 x 8-3/8	-	239.00
SHC002*	CB2-LS-CUSTOM	Standard with Strobe	16 x 14-58 x 8-3/8	-	259.00
SAX737	8000-0814	Semi Recessed	17-1/2 x 17-1/25 x 2-1/2	7	465.00
SHC007	SR-L-CUSTOM	Semi Recessed	17-1/4 x 17-1/4 x 3	6-3/4	279.00
SHC006	FR-L-CUSTOM	Fully Recessed	7-3/8 x 17-3/8 x 3/8	6-3/4	269.00

## AED PLUS®

### WALL MOUNTING BRACKET

- For use with the Zoll® AED Plus® without the soft case

Model No.	Mfg. No.	Price /Each
SAX738	8000-0809-01	93.50



## AED PLUS® SOFT CARRYING CASE

- Replacement soft carrying case

Model No.	Mfg. No.	Price /Each
SAR365	8000-0802-01	155.00



## AED PLUS® TRAINING ACCESSORIES



Model No.	Mfg. No.	Description	Price /Each
SAX742	8000-0835-01	Training Mannequin	279.00
SGR028	8000-000925	Battery-Powered AED Electronic Simulator	585.00
SGR439	8900-5007	CPR-D Demo Electrodes	179.00

## COMPARISON CHART

	Zoll® AED PLUS®	Zoll® AED 3™		Zoll® AED PLUS®	Zoll® AED 3™
IP rating	IP55	IP55	Escalating Energy	x	x
Voice prompts, text prompts and metronome	x	x	Biphasic Therapy	x	x
Daily, weekly, monthly self checks	x	x	Touch Screen configuration		x
Available in Semi or Fully Automatic	x	x	WiFi capability		x
Battery Shelf Life	5 yrs	5 yrs	Easily configure to English or French		x
Electrode Pad Shelf Life	5 yrs	5 yrs*	Large, full colour screen		x
Pediatric Pad Shelf Life	2 yrs	5 yrs*	Device Warranty	7 yrs available	8 yrs available

\*Universal pad for both adult and pediatric use



## ZOLL® AED 3™

- Zoll® Real CPR Help™ offers rescuers unparalleled technology with integrated, real-time CPR feedback on BOTH depth and rate of compressions
- Zoll® Real CPR Help™ can measure rescuer compressions and guides rescuers to the Canadian Heart and Stroke Foundation's recommended 2" depth of compressions with voice and text prompts, in real-time, to "press harder" and follows with "good compressions" when the rescuer reaches the required depth
- Both pads and batteries include a 5 year shelf life offering a low cost of ownership as well as simplified AED program management (less replacement cycles)
- The original language configuration of the unit, can be changed to deliver English or French prompts, by accessing the Supervisor set-up menu
- Integrated pediatric rescue with the use of universal CPR Uni-padz™ for both adult and pediatric rescues
- Larger screen offers dynamic rescue images in full colour for enhanced rescuer support along with voice prompts, text prompts and metronome
- 8 year device warranty (6 years + 2 years after product registration)
- Zoll's Biphasic Therapy measures the victim's impedance and delivers the appropriate level of shock as well as escalating energy shocks through the rescue
- Defaults to weekly and monthly self tests, can be configured to daily
- WiFi enabled to easily monitor and manage AED readiness, transfer case data post-event, and any protocol change program updates
- IP55 rating for protection against dust and water
- Kit includes: Zoll® AED 3™, Zoll® CPR Uni-padz™ universal electrodes for adult or pediatric rescue (5 year shelf life), AED 3™ battery pack (5 year shelf life), fast response rescue kit, manuals and orientation DVD



Model No.	Mfg. No.	Description	Price /Each
<b>DEFIBRILLATORS</b>			
SGC079	8501-001102-06	Fully Automatic AED 3 - English	2385.00
SGC080	8501-001102-26	Fully Automatic AED 3 - French	2385.00
SGC077	8501-001101-06	Semi Automatic AED 3 - English	2385.00
SGC078	8501-001101-26	Semi Automatic AED 3 - French	2385.00
<b>ACCESSORIES</b>			
SAR368	8900-0807-01	CPR-D Accessory Kit	27.50
SGZ855	8900-000280	CPR Uni-Padz™ Electrodes (5-Year Shelf Life)	275.00
SGC082	8000-000696	Replacement Battery Pack (5-Year Shelf Life)	255.00

\*Universal pad for both adult and pediatric use

## WALL/VEHICLE AED MOUNTING DEVICE

- Mountable wall or vehicle device designed to store any AED secured with a Velcro strap
- For Use With: Universal
- Medical Device Class: Non-Medical
- Dimensions: 9"H x 8.5"L x 4.125" x 6.125"D
- Weight: 3 lbs.

**Model No. SHC008**  
**Mfg. No. AB1**  
**Price/Each \$79.95**



## AED WALL CABINET

- Includes an ILCOR AED label set and installation instructions
- Easy installation
- Keep your defibrillator secure and accessible for medical emergencies
- Battery operated alarm (9-volt battery included)



Model No.	Mfg. No.	Description	Dimensions"	Interior Depth"	Price /Each
SGP849	8000-001256	Standard	17.5 x 17.5 x 7	7	415.00
SGP850	8000-001257	Semi-Recessed	14 x 14 x 3.5	7	445.00
SGP851	8000-001258	Fully-Recessed	14 x 14" x 1.5	7	445.00

## AED 3™ WALL MOUNT BRACKET

- Simple, light weight wall mounted bracket to hold Zoll® AED 3™
- Includes green ILCOR AED symbol
- Includes mounting hardware, consumable tracking card, wall-mount template and installation instructions



Model No.	Mfg. No.	Description	Price /Each
SGC083	8000-001255	Holds the Zoll® AED 3™ without a carry case	85.90
SGP848	8000-001266	Holds the Zoll® AED 3™ alone or in its carry case	92.90

## AED 3™ STANDARD CARRY CASE

- Able to accommodate the Zoll® AED 3™ with pre-connected CPR Uni-padz™ and a backup set of CPR Uni-padz™

Model No.	Mfg. No.	Price /Each
SGP846	8000-001250	189.00



## AED 3™ TRAINING ACCESSORIES



Model No.	Mfg. No.	Description	Price /Each
SAX742	8000-0835-01	Training Mannequin	279.00
SGR028	8000-000925	Battery-Powered AED Electronic Simulator	585.00
SGZ856	8900-000284	CPR Uni-Padz™ Training Demonstration Electrodes	169.00
SGZ857	8900-000285	CPR Uni-Padz™ Training Replacement Reusable Gels (8 Sets of 2)	139.00

# FIRST AID & MEDICAL EQUIPMENT

## CSA FIRST AID KITS

- These CSA kits are approved in Canada except for Nova Scotia and British Columbia
- See below and following page for the Nova Scotia and British Columbia kits



SGR340



SGR327



SGR339



Model No.	Mfg No.	Kit Type	Size	Container Type	Price /Each
<b>BULK FIRST AID KITS</b>					
SGR327	FAKCSAT1BP	Kit #1	Personal	Plastic Box - 10-Unit	25.10
SGR328	FAKCSAT1BM	Kit #1	Personal	Metal Box - 10-Unit	41.90
SGR329	FAKCSAT1BN	Kit #1	Personal	Nylon Pouch - 5" x 4"	23.60
SGW400	FAKCSAT1BR	Kit #1	Personal	Refill Kit	19.90
SGR346	FAKCSAT2SBP	Kit #2	Small	Plastic Box - 16-Unit	42.30
SGR345	FAKCSAT2SBM	Kit #2	Small	Metal Box - 16-Unit	55.90
SGR344	FAKCSAT2SBN	Kit #2	Small	Nylon Pouch - 9" x 4"	40.50
SGW402	FAKCSAT2SBR	Kit #2	Small	Refill Kit	39.00
SGR342	FAKCSAT2MBP	Kit #2	Medium	Plastic Box - 36-Unit	67.20
SGR341	FAKCSAT2MBM	Kit #2	Medium	Metal Box - 36-Unit	94.20
SGR343	FAKCSAT2MBN	Kit #2	Medium	Nylon Pouch - 8" x 12"	72.30
SGW399	FAKCSAT2MBR	Kit #2	Medium	Refill Kit	54.60
SGR347	FAKCSAT2LBP	Kit #2	Large	Plastic Box - 40-Unit	150.00
SGR340	FAKCSAT2LBM	Kit #2	Large	Metal Box - 40-Unit	134.00
SGR339	FAKCSAT2LBN	Kit #2	Large	Nylon Pouch - 16" x 12"	113.00
SGW401	FAKCSAT2LBR	Kit #2	Large	Refill Kit	91.20
SGR338	FAKCSAT3SBP	Kit #3	Small	Plastic Box - 36-Unit	81.60
SGR337	FAKCSAT3SBM	Kit #3	Small	Metal Box - 36-Unit	116.00
SGR336	FAKCSAT3SBN	Kit #3	Small	Nylon Pouch - 13" x 9"	80.60
SGW405	FAKCSAT3SBR	Kit #3	Small	Refill Kit	70.30
SGR330	FAKCSAT3MBP	Kit #3	Medium	Plastic Box - 40-Unit	157.00
SGR331	FAKCSAT3MBM	Kit #3	Medium	Metal Box - 40-Unit	156.00
SGR332	FAKCSAT3MBN	Kit #3	Medium	Nylon Pouch - 16" x 12"	120.00
SGW404	FAKCSAT3MBR	Kit #3	Medium	Refill Kit	101.00
SGR334	FAKCSAT3LBP	Kit #3	Large	Plastic Box - 40-Unit	211.00
SGR335	FAKCSAT3LBM	Kit #3	Large	Metal Box - 40-Unit	214.00
SGR333	FAKCSAT3LBN	Kit #3	Large	Nylon Pouch - 16" x 12"	180.00
SGW403	FAKCSAT3LBR	Kit #3	Large	Refill Kit	164.00

Content of Kits	Kit #1 Personal	Kit #2			Kit #3		
		Small	Medium	Large	Small	Medium	Large
Adhesive Plastic Strips 1" x 3"	10	13	35	70	13	35	70
Adhesive finger tips dressing, Large	2	4	5	10	4	5	10
Adhesive knuckle tips dressing	2	4	5	10	4	5	10
Adhesive fabric squares 2" x 3"	2	4	5	10	4	5	10
Gauze Pad 3" x 3" sterile	6	12	24	48	12	24	48
Gauze Pad 4" x 4" sterile	-	-	-	-	6	12	24
Telfa pad 2" x 3"	-	-	-	-	4	8	16
Abdominal Pad 5" X 9" sterile	-	1	2	2	1	2	4
Conform bandage 2" X 5 yards	1	1	2	4	1	2	4
Conform bandage 4" X 5 yards	-	1	2	4	1	2	4
Compress Bandage 4" sterile	2	2	4	8	1	2	4
Compress Bandage 6" sterile	-	-	-	-	1	2	4
Triangular Bandage	1	2	4	8	2	4	8
Adhesive Tape 1" X 2.5 yards	1	1	-	-	1	-	-
Adhesive Tape 1" X 5 yards	-	-	1	-	1	-	-
Adhesive Tape 1" X 10 yards	-	-	-	1	-	-	1
Tensor 3" x 5 yards	-	-	-	-	1	2	2
Eye pad sterile	-	-	-	-	2	2	4
Eye shield	-	-	-	-	2	2	4
Instant cold pack	-	-	-	-	1	2	4
Antibiotic cream	2	6	12	24	6	12	24
Benzalkonium antiseptic wipes	6	25	50	100	25	50	100
Hand cleaning wipes	4	6	12	24	6	12	24
Rescue breather	-	1	1	1	1	1	1
Disposable gloves (1 pair)	2	4	8	16	4	8	16
Tweezers 4 1/2"	1	1	1	1	1	1	1
Biohazard bags	1	1	2	2	2	4	8
Scissors	-	1	1	1	1	1	1
Mylar blanket	-	1	1	1	1	2	2
Metal splint 24"	-	-	-	-	1	1	2
Splint padding	-	-	-	-	1	1	2
Glucose	-	-	-	-	1	2	2
Arterial tourniquet	-	-	-	-	1	1	1

## NOVA SCOTIA CSA FIRST AID KITS

Model No.	Mfg No.	Kit Type	Size	Container Type	Price /Each
<b>BULK FIRST AID KITS</b>					
SHL271	FAKCSA24T1BM	Kit #1	Personal	Metal Box	35.00
SHL272	FAKCSA24T1BN	Kit #1	Personal	Nylon Pouch	25.00
SHL273	FAKCSA24T1BP	Kit #1	Personal	Plastic Box	25.00
SHL274	FAKCSA24T2SBM	Kit #2	Small	Metal Box	59.00
SHL275	FAKCSA24T2SBN	Kit #2	Small	Nylon Pouch	49.00
SHL276	FAKCSA24T2SBP	Kit #2	Small	Plastic Box	49.00
SHL277	FAKCSA24T2MBM	Kit #2	Medium	Metal Box	94.96
SHL278	FAKCSA24T2MBN	Kit #2	Medium	Nylon Pouch	72.47
SHL279	FAKCSA24T2MBP	Kit #2	Medium	Plastic Box	69.19
SHL280	FAKCSA24T2LBM	Kit #2	Large	Metal Box	128.57
SHL281	FAKCSA24T2LBN	Kit #2	Large	Nylon Pouch	109.00
SHL282	FAKCSA24T2LBP	Kit #2	Large	Plastic Box	143.72
SHL283	FAKCSA24T3SBM	Kit #3	Small	Metal Box	104.58
SHL284	FAKCSA24T3SBN	Kit #3	Small	Nylon Pouch	72.13
SHL285	FAKCSA24T3SBP	Kit #3	Small	Plastic Box	79.00
SHL286	FAKCSA24T3MBM	Kit #3	Medium	Metal Box	140.00
SHL287	FAKCSA24T3MBN	Kit #3	Medium	Nylon Pouch	105.30
SHL288	FAKCSA24T3MBP	Kit #3	Medium	Plastic Box	140.00
SHL289	FAKCSA24T3LBM	Kit #3	Large	Metal Box	204.82
SHL290	FAKCSA24T3LBN	Kit #3	Large	Nylon Pouch	150.00
SHL291	FAKCSA24T3LBP	Kit #3	Large	Plastic Box	202.54

SHL272



SHL277



SHL289



# FIRST AID & MEDICAL EQUIPMENT

## BRITISH COLUMBIA CSA FIRST AID KITS



SGM225

**NEW BRITISH COLUMBIA FIRST AID KITS LAUNCHING NOVEMBER 2024**



Model No.	Mfg No.	Kit Type	Container Type	Price /Each
<b>BULK FIRST AID KITS</b>				
SGM221	FAKBCNPBN	Personal	Nylon Pouch - 6" x 4"	10.30
SGM220	FAKBCNPBZ	Personal	Ziplock bag	7.17
SGM222	FAKBCNBABP	Basic	Plastic Box - 10-Unit	34.20
SGM223	FAKBCNBABM	Basic	Metal Box - 10-Unit	47.90
SGM224	FAKBCNBABN	Basic	Nylon Pouch - 8" x 12"	30.30
SGM225	FAKBCN1BP	Level #1 w/rescue breather	Plastic Box - 36-Unit	128.00
SGM226	FAKBCN1BM	Level #1 w/rescue breather	Metal Box - 36-Unit	132.00
SGM227	FAKBCN1BN	Level #1 w/rescue breather	Nylon Pouch - 12" x 10"	93.70
SGM228	FAKBCN2BP	Level #2 w/rescue breather	Plastic Box - 48-Unit	152.00
SGM229	FAKBCN2BM	Level #2 w/rescue breather	Metal Box - 48-Unit	142.00
SGM230	FAKBCN2BN	Level #2 w/rescue breather	Nylon Pouch - 13" x 13"	113.00
SGM231	FAKBCN3BN	Level #3 w/rescue breather	Nylon Pouch - 16" x 12"	136.00

<b>BULK FIRST AID KIT REFILLS</b>				
SGP226	FAKBCNBR	Refill for first aid kit Basic		25.70
SGP227	FAKBCN1R	Refill for first aid kit Level #1 w/rescue breather		86.60
SGP228	FAKBCN2R	Refill for first aid kit Level #2 w/rescue breather		98.00
SGP229	FAKBCN3R	Refill for first aid kit Level #3 w/rescue breather		122.00

Content of Kits	Personal Kit	Basic Kit	Level 1 Kit	Level 2 Kit	Level 3 Kit
Accident record book	-	-	1	1	1
Patient chart	-	-	-	-	1
Plastic strips 3/4" x 3"	3	4	20	20	20
Plastic strips 1" x 3"	3	4	20	20	20
Fabric knuckle strips	-	1	5	5	5
Fabric finger strips	-	1	5	5	5
Gauze pad 4" x 4" sterile	-	6	10	20	20
Compress Bandage 4-1/2" x 6-1/2"	1	1	4	4	4
Conform bandages 3"	-	-	2	2	4
Tensor bandage 3"x 5 yds	-	1	2	2	4
Triangular bandage	-	1	2	4	6
Adhesive tape 1" x 5 yds	-	1	1	2	2
Benzalkonium antiseptic wipes	6	6	24	24	24
Aluminium blanket	-	-	1	1	1
Tourniquet windlass	-	-	1	1	1
Fast strap	-	-	2	2	4
Paramedic scissors 5"	-	1	1	1	1
Splinter forceps, straight 4-1/2"	-	-	1	1	1
Abdominal Pad 8" x 10"	-	-	-	4	4
C.P.R. mask w/one way valve	-	-	1	1	1
Pen light	-	-	-	-	1
Disposable gloves (1 pair)	-	3	6	6	6
Ziplock 8" x 10"	1	1	1	1	1

## ONTARIO WCB REGULATIONS FIRST AID KITS



SGA957



Model No.	Mfg No.	Kit Type	Container Type	Price /Each
<b>BULK FIRST AID KITS</b>				
SGA993	FAKONTABP	Kit #A	Plastic box - 10 units	17.10
SGA995	FAKONTABM	Kit #A	Metal box - 10 units	39.80
SGA994	FAKONTABN	Kit #A	Nylon pouch - 10 units	15.60
SGA959	FAKONT1BP	Kit #1	Plastic box - 36 units	46.40
SGA957	FAKONT1BM	Kit #1	Metal box - 36 units	70.60
SGA947	FAKONT1BN	Kit #1	Nylon pouch - 36 units	42.60
SGB074	FAKONT2BP	Kit #1	Plastic box	119.00
SGB073	FAKONT2BM	Kit #2	Metal box	113.00
SGA934	FAKONT2BN	Kit #2	Nylon pouch	77.40
SGA946	FAKONTTFBP	Kit #TFB	Plastic box - 10 units	28.20
SGA944	FAKONTTFBM	Kit #TFB	Metal box - 10 units	45.90
SGA945	FAKONTTFBN	Kit #TFB	Nylon pouch	23.30
<b>BULK FIRST AID KIT REFILLS</b>				
SGB248	FAKONTAR	Refill for WBC bulk first aid kit #A	-	13.30
SGB230	FAKONT1R	Refill for WBC bulk first aid kit #1	-	34.40
SGB238	FAKONT2R	Refill for WBC bulk first aid kit #2	-	64.90
SGB264	FAKONTFR	Refill for WBC #TFB bulk first aid kit	-	19.70
<b>UNITIZED FIRST AID KITS</b>				
SGB045	FAKONTAUP	Kit #A	Plastic box - 10 units	29.70
SGB044	FAKONTAUM	Kit #A	Metal box - 10 units	48.20
SGB047	FAKONT1UP	Kit #1	Plastic box 36 units	65.00
SGB046	FAKONT1UM	Kit #1	Metal box 36 units	112.00
SGA933	FAKONT2UM	Kit #2	Metal box	168.00
SGB019	FAKONTTFBUP	Kit #TFB	Plastic box - 16 units	44.60
SGB018	FAKONTTFBUM	Kit #TFB	Metal box - 16 units	62.30
<b>UNITIZED FIRST AID KIT REFILLS</b>				
SGB268	FAKONTAUR	Refill for WBC unitized first aid kit #A	-	21.40
SGB267	FAKONT1UR	Refill for WBC unitized first aid kit #1	-	58.00
SGB266	FAKONT2UR	Refill for WBC unitized first aid kit #2	-	87.50
SGB265	FAKONTFRU	Refill for WBC #TFB unitized first aid kit	-	34.30

Content of Kits	KIT #A (1-5 emp.)	KIT #1 (6-15 emp.)	KIT #2 (16-200 emp.)	Kit #TFB (TFB)
First aid manual	1	1	1	1
Plastic adhesive strips 3/4" x 3" sterile	12	24	48	16
Pressure bandage 4" sterile	2	4	6	2
Gauze bandage roll 1" x 5 yds	-	-	12	-
Gauze bandage roll 2" x 5 yds	2	4	8	-
Gauze bandage roll 3" x 5 yds	-	-	-	4
Gauze bandage roll 4" x 5 yds	-	4	8	-
Gauze pad 3" x 3" sterile	4	12	48	6
Triangular bandage	1	6	12	4
Splint padding	-	2	2	-
Metal wire splint	-	1	-	-
Wood splints (set of 6)	-	-	1	-
Safety pins (pack of 12)	1	1	2	1
Adhesive tape 1" x 5 yds	-	-	2	-
Emesis basin	-	-	1	-
Disposable gloves (1 pair)	1	1	1	1



# FIRST AID & MEDICAL EQUIPMENT

## SWIMMING POOL FIRST AID KIT

- Ideal for on-site treatment of injuries that may occur at a swimming pool
- Contains provisions to treat small and large injuries
- Includes an assortment of bandages, gauze, adhesive tape, and splints



Model No.	Mfg No.	Container Type	Price /Each
SGB344	FAKPOOL36BP	Plastic box - 36 units	98.00

## FEDERAL LABOUR BOARD FIRST AID KITS



Model No.	Mfg No.	Description	Contents	Price /Each
<b>FIRST AID KITS</b>				
SGB059	FAKFEDABP	10 Units - Plastic box	A	33.20
SGB058	FAKFEDABM	10 Units - Metal box	A	58.80
SGB061	FAKFEDBBP	24 Units - Plastic box	B	62.50
SGB060	FAKFEDBBM	24 Units - Metal box	B	83.70
SGB063	FAKFEDCBP	Plastic box	C	185.00
SGB062	FAKFEDCBM	Metal box	C	184.00
SGB065	FAKFEDDBP	10 Units - Plastic box	D	16.80
<b>FIRST AID KIT REFILLS</b>				
SGB221	FAKFEDAR	Refill for SGB059 & SGB058	A	24.50
SGB222	FAKFEDBR	Refill for SGB061 & SGB060	B	58.90
SGB223	FAKFEDCR	Refill for SGB063 & SGB062	C	111.00
SGB224	FAKFEDDR	Refill for SGB065	D	10.60

Content of Kits	Kit A	Kit B	Kit C	Kit D
Accident Record Book	1	1	1	1
Nickel Plated Tweezers	1	1	1	-
Scissors 7 1/2"	-	-	1	-
Scissors 5 1/2"	1	1	-	-
Compress Bandage 4" sterile	1	2	-	-
Plastic Strips 3/4" x 3" Sterile	12	48	100	6
Gauze Pad Sterile 4" x 4"	4	12	24	2
Gauze Sponge 4" x 4"	10	40	200	-
Conform Bandage 3" x 5"	2	6	24	-
Abdominal Pad 5" x 9"	-	-	6	-
Triangular Bandage	2	6	8	1
Adhesive Tape 1/2" x 5 yds	-	-	-	1
Adhesive Tape 1" x 5 yds	1	2	4	-
Benzalkonium Wipes	10	10	40	10
Rescue Breather	1	1	1	-
Aluminum Blanket	1	-	-	-
Ziplock Bag 4" x 6"	-	-	2	-
Disposable Gloves (1 pair)	2	4	20	-

## DAY CARE FIRST AID KITS

- Designed for injuries and illnesses that may occur at a day care facility
- Contains supplies to treat small wounds and abrasions, and help reduce the transmission of communicable illnesses
- Includes an assortment of bandages, gauze, antiseptic, and thermometers



SGA797



SGA799



Model No.	Mfg No.	Container Type	Price /Each
SGA799	FAKDC36BP	Plastic box - 36 units	110.00
SGA797	FAKDC36BM	Metal box - 36 units	139.00

## GENERAL PURPOSE INDUSTRIAL FIRST AID KITS

- Features an assortment of supplies for treating common injuries, wounds, and burns



SGB076



SGB072



Model No.	Mfg No.	Description	Container Type	Price /Each
<b>FIRST AID KITS</b>				
SGB071	FAK25	For 25 employees or less	Metal box	216.00
SGB072	FAK50	For 25 employees or more	Metal box	300.00
SGB070	FAK33	For 200 employees or less	Metal box	367.00
SGB076	FAK40	Maxi kit	Metal box	327.00
<b>FIRST AID KIT REFILLS</b>				
SGB217	FAK25R	-	Refill for SGB071	154.00
SGB220	FAK50R	-	Refill for SGB072	156.00
SGB218	FAK33R	-	Refill for SGB070	226.00
SGB219	FAK40R	-	Refill for SGB076	193.00

# FIRST AID & MEDICAL EQUIPMENT

## EMERGENCY ROAD HAZARD FIRST AID KITS

- Ideal for use during a roadside emergency
- Contains a variety of first aid and emergency rescue supplies
- Includes bandages and antiseptic, as well as matches, candles, and various other supplies to aid in response to a roadside emergency



Model No.	Mfg No.	Description	Price /Each
SGB288	FAKROADBN	Road hazard kit in nylon pouch	69.70
SGA865	FAKERH	Extreme road hazard kit in nylon pouch	86.50
SGA770	FAKCARBC	Car First aid kit in nylon pouch	33.10

## S.O.S. EMERGENCY ROAD SIDE KIT

- Designed to aid in motorist distress emergencies
- Includes an S.O.S. flag, booster cables, flashlight, screwdriver, and more



Model No.	Mfg No.	Container Type	Price /Each
SGB317	FAKSOSRHK	S.O.S. emergency kit in nylon pouch	65.40

## SPORTS & ACTIVITIES FIRST AID KITS

- Ideal for on-site treatment of activity-related injuries
- Nylon Pouch



Model No.	Mfg No.	Kit Type	Price /Each
SGB015	FOAKSPORTBN	Sports, golf, ski, bike, hiking, jogging	36.20
SGA775	FAKSAWBN	Forestry	17.00

## INFECTION CONTROL FIRST AID KIT

- Designed to mitigate the spread of infection
- Contains a variety of supplies including gloves, glasses, face mask, apron and more



Model No.	Mfg No.	Container Type	Price /Each
SGB140	FAK1FCBP	Plastic box - 10 units	33.60

**MATRIX**  
INDUSTRIAL PRODUCTS

Maintain the ideal temperature in your workplace

## MULTIPURPOSE FIRST AID KITS

- Designed to treat a variety of common minor injuries
- Contains various bandages and antiseptic



Model No.	Mfg No.	Container Type	Price /Each
SGB191	FAKPKBN	Personal First aid kit - Nylon pouch	28.80
SGB056	FAK10BP	Fast First aid kit - Plastic box 10 units	39.60

# FIRST AID & MEDICAL EQUIPMENT

## FIRST RESPONDER FIRST AID KITS

- Contains a variety of first aid and emergency rescue supplies for quick response to medical emergencies



SGB354



Model No.	Mfg No.	Kit Type	Container Type	Price /Each
SGB354	FAKTRAUN	Trauma first responder kit	Nylon pouch	460.00

## VESSEL FIRST AID KITS

- Designed to treat injuries that may occur while working on a vessel
- Includes an accident record book and a variety of bandages, antiseptic, and instruments



SGB369



Model No.	Mfg No.	Container Type	Kit Type	Number of Employees	Price /Each
SGB367	FAKMOHSABP	Plastic box	Type A	2 to 5	58.40
SGB366	FAKMOHSABM	Metal box	Type A	2 to 5	88.80
SGB369	FAKMOHSBBP	Plastic box	Type B	6 to 19	87.70
SGB368	FAKMOHSBBM	Metal box	Type B	6 to 19	114.00
SGB371	FAKMOHSCBP	Plastic box	Type C	20 to 49	187.00
SGB370	FAKMOHSCBM	Metal box	Type C	20 to 49	195.00
SGB373	FAKMOHSDBP	Plastic box	Type D	50+	218.00
SGB372	FAKMOHSDBM	Metal box	Type D	50+	300.00
SGB374	FAKMOHSER	Ziplock bag	Type E	Isolated work place	19.10

## BIOHAZARD SPILL CLEAN-UP FIRST AID KITS

- Designed to clean up minor spills
- Includes instructions and a variety of antiseptic, personal protection equipment, and biohazard supplies



SGA823



Model No.	Mfg No.	Kit Type	Container Type	Price /Each
SGA826	FAKPB01	Personnel protection kit	Ziplock bag	21.40
SGA823	FAKPB02	Clean all kit	Ziplock bag	20.70
SGA824	FAKPB03	Complete precaution compliance kit	Plastic box - 10 units	34.00

## DISASTER SURVIVAL FIRST AID KITS

- Contains a variety of first aid supplies and emergency provisions
- Includes food and water rations, light sticks, toilet paper, whistles, and more



SGA997



Model No.	Mfg No.	Description	Container Type	Price /Each
SGA996	FASURV13	Cares for 1 person for 3 days	Nylon Bag	88.80
SGA997	FASURV23	Cares for 2 people for 3 days	Nylon Bag	235.00
SGA998	FAKSURD43	Cares for 4 people for 3 days	Nylon Bag	467.00
SGA802	FAKSURBK23	Cares for 2 people for 3 days	Bucket	165.00
SGA803	FAKSURBK33	Cares for 3 people for 3 days	Bucket	216.00
SGA804	FAKSURBK43	Cares for 4 people for 3 days	Bucket	271.00
SGA805	FAKSURBK53	Cares for 5 people for 3 days	Bucket	316.00

## BOAT & LIFE RAFT FIRST AID KITS

- Ideal for use on life rafts and fishing boats
- Includes a variety of bandages and instruments for treating both small and large injuries



SGB081



Model No.	Mfg No.	Kit Type	Container Type	Price /Each
SGB162	FAKLB	Liferaft	Clear vinyl waterproof pouch	45.70
SGB080	FAKMARINE1	Fishing vessel	Plastic box - 10 units	35.90
SGB081	FAKMARINE2	Fishing vessel	Plastic box - 16 units	65.40

## WELDERS' FIRST AID KITS

- Designed to treat injuries that may occur while welding
- Includes a first aid manual, and a variety of ointments, bandages, eye wash, and instruments



SGB055



Model No.	Mfg No.	Container Type	Price /Each
SGB054	FAKWELDBP	Plastic box - 10 units	47.10
SGB055	FAKWELDXBP	Plastic box - 24 units	94.90



## METAL CASES FOR INDUSTRIAL FIRST AID KITS

- Strong and rugged
- Folded Metal
- Baked-on enamel finish
- Square corners
- Wall mount brackets
- Positive closure clips



Model No.	Mfg No.	Dimensions"	Price /Each
SGA837	FAK13MB	9 x 12 x 4	92.90
SGA839	FAK15MB	16 x 13.5 x 6.5	109.00
SGA840	FAK16MB	16 x 15.5 x 5.5	125.00
SGA841	FAK20MB	22 x 15 x 5.5	128.00



## METAL CASES FOR UNITIZED OR BULK FIRST AID KITS

- Strong and rugged
- Baked-on enamel finish
- Gasketed models moisture and dust-proof
- Rounded corners
- Wall mount brackets and positive closure clips



Model No.	Mfg No.	Capacity	Dimensions"	Price /Each
SGA843	FAKT10M	10 units	7.5 x 5 x 3	30.20
SGA845	FAKT16M	16 units	10 x 7 x 3	32.80
SGA847	FAKT24M	24 units	10 x 10 x 3	39.30
SGA849	FAKT36M	36 units	13.5 x 9.5 x 3	58.20



## PLASTIC CASES FOR FIRST AID KITS

- Durable and economical
- Non-rusting and scratch resistant
- Strong and lightweight
- Carry handle and wall mount brackets



Model No.	Mfg No.	Capacity	Dimensions"	Price /Each
SGA842	FAKT010	10 units	7.5 x 5 x 3.5	7.51
SGA844	FAKT016	16 units	10 x 7 x 3	8.23
SGA846	FAKT024	24 units	10 x 10 x 3	14.00
SGA848	FAKT036	36 units	13.5 x 9.5 x 3	18.90
SGA850	FAKT040	Industrial	16 x 12 x 5	60.10



## BAGS & POUCHES FOR FIRST AID KITS

- Strong and rugged
- Lightweight & flexible



Model No.	Mfg No.	Description	Price /Each
SGB314	FANP6X4	Small flat nylon bag with zipper closure and belt loop	3.40
SGB313	FANP5X4	Small square nylon bag with zipper closure and belt loop	4.48
SGA796	FANP9X4	Cylindrical nylon bag 9" x 4" with handles	4.07
SGA795	FANP5X10	Cylindrical nylon bag 10" x 5" with handles	6.21
SGB160	FANP8X12	Large bag 8" x 12" x 3" with zipper closure, handle and inside pocket	16.40
SGB378	FANP13X9	X-Large bag 13" x 9" x 4" with zipper closure and handle	13.10
SGB379	FANP13X9ERK	X-Large bag 13" x 9" x 4" with zipper closure and handle	15.70
SGB161	FANPTRAUMA	Large trauma bag with handle and shoulder strap 19" x 11" x 13"	118.00
SGB176	FANPSURVBL	Large survival kit blue bag with handle and shoulder strap 16" x 12" x 8"	86.80



# FIRST AID & MEDICAL EQUIPMENT

## HOT & COLD THERAPY PRODUCTS

- Hot therapy provides relief for stiff joints, muscle aches and pains, tension and cramps
- Cold therapy provides relief for swelling, muscle spasms and pains, headaches and minor injuries

SGB285



SGB142



SGB145



Model No.	Mfg No.	Description	Size"	Price /Each
-----------	---------	-------------	-------	-------------

### INSTANT COMPRESSES

SGB145	FAHP6X10	Hot	6 x 10	4.42
SGB142	FACP4X6	Cold	4 x 6	1.36
SGB143	FACP5X9	Cold	5 x 9	1.78

### REUSABLE COMPRESSES

SGB285	FARHC565	Hot/Cold	5 x 6,5	4.38
SGB286	FARHC856	Hot/Cold	8,5 x 6	6.36
SGB284	FARHC1010	Hot/Cold	10 x 10	12.90

## INSTANT COLD COMPRESSES

- For relief of pain and swelling caused by sprains, strains, contusions, and other minor injuries
- Easy to use cold therapy without the mess of ice or ice cubes
- No refrigeration needed
- Convenient and portable
- Single Use
- Medical Device Class: Class 1



SGW783

SGX568



Model No.	Dimensions"	Price /Each
SGW783	5 x 6	1.00
SGX568	6 x 9	1.30

## INSTANT HOT COMPRESSES

- Instant warm therapy for relief of sore muscles, muscle spasms and joint stiffness
- Stays warm for up to 30 minutes
- Reaches temperatures of up to 45°C (113°F)
- Convenient and portable
- Single Use
- Medical Device Class: Class 1



Model No.	Dimensions"	Price /Each
SGX053	6 x 9	1.50

## BURN-EZE PRODUCTS

- Good for all types of burn injuries
- Foam-gel is very concentrated for fast pain relief and to "Cool" the burn quickly
- Protects the wound from contamination
- Gel can be applied directly on the wound
- Ideal for welders and any applications where burns can occur

Model No.	Mfg No.	Description	Size	Qty	Price /Each
<b>BURN-EZE PAIN RELIEVING GEL</b>					
SGA762	FABF35	Single dose packets	1/8 oz. (3.5 g)	1 unit	1.05
SGA766	FABF35U6	Single dose packets	1/8 oz. (3.5 g)	6/box	8.26
SGA764	FABF35B25	Single dose packets	1/8 oz. (3.5 g)	25/box	22.70
SGA763	FABF118	Squeeze bottle	4 oz. (118 ml)	1 unit	11.00
<b>BURN-EZE STERILE DRESSING</b>					
SGA758	FABF2X6	Burn dressing	2" x 6"	1 unit	4.71
SGA759	FABF4X4	Burn dressing	4" x 4"	1 unit	6.48
SGA761	FABF12X16	Facial burn dressing	12" x 16"	1 unit	25.10

Model No.	Mfg No.	Description	Size	Container Type	Price /Each
<b>BURN-EZE BURN KITS</b>					
SGB186	FAKBKP	Personal burn kit	10 units	Plastic box	40.70
SGA834	FAKBKEMR	Emergency burn kit	10 units	Plastic box	67.40
SGB282	FAKBKRS	Small Restaurant burn kit	10 units	Plastic box	44.80
SGB283	FAKBKRL	Large Restaurant burn kit	16 units	Plastic box	70.70
SGB171	FAKBKMP	Multipurpose burn kit	16 units	Plastic box	95.20
SGB139	FAKBKIND	Industrial burn kit	16 units	Plastic box	125.00

Contents	SGB186	SGA834	SGB282	SGB283	SGB171	SGB139
2" x 6" burn dressing SGA758	2	2	1	3	3	3
4" x 4" burn dressing SGA759	1	2	1	4	3	3
8" x 8" burn dressing SGA760	-	-	-	-	2	2
12" x 16" Facial burn dressing SGA761	-	-	-	-	-	1
Pain relieving gel, 4 oz. squeeze bottle SGA763	1	1	1	1	1	2
Pain relieving gel, 1/8 oz. sachet SGA762	3	12	6	12	12	25
Gauze in roll SGB092	-	2	-	-	3	4



SGB186

SGA763

SGA762

SGA759

# FIRST AID & MEDICAL EQUIPMENT

## GAUZE PADS

- Ideal for wound dressing, treatment, and cleansing



Model No.	Mfg No.	Dimensions	Description	Thickness	Qty	Price /Each
<b>GAUZE PAD - 12 PLY</b>						
SGB110	FAGP2X2B6	2" x 2"	Sterile	12 ply	Box of 6	2.80
SGB109	FAGP2X2B12	2" x 2"	Sterile	12 ply	Box of 12	3.67
SGB108	FAGP2X250	2" x 2"	Sterile	12 ply	Bag of 50	7.32
SGB107	FAGP2X2100	2" x 2"	Sterile	12 ply	Box of 100	8.86
SGB118	FAGP3X3B4	3" x 3"	Sterile	12 ply	Box of 4	2.71
SGB119	FAGP3X3B8	3" x 3"	Sterile	12 ply	Box of 8	3.57
SGB111	FAGP3X350	3" x 3"	Sterile	12 ply	Bag of 50	9.40
SGB117	FAGP3X3100	3" x 3"	Sterile	12 ply	Box of 100	14.70
SGB122	FAGP4X4B4	4" x 4"	Sterile	12 ply	Box of 4	3.40
SGB123	FAGP4X4B8	4" x 4"	Sterile	12 ply	Box of 8	4.61
SGB120	FAGP4X450	4" x 4"	Sterile	12 ply	Bag of 50	15.00
SGB121	FAGP4X4100	4" x 4"	Sterile	12 ply	Box of 100	18.30
<b>GAUZE PAD - 8 PLY</b>						
SGB112	FAGS2X2	2" x 2"	Non-sterile	8 ply	Bag of 200	5.51
SGB113	FAGS3X3	3" x 3"	Non-sterile	8 ply	Bag of 200	11.20
SGB114	FAGS4X4	4" x 4"	Non-sterile	8 ply	Bag of 200	15.60
<b>TRAUMA PAD</b>						
SGB355	FATP10X30	10" x 30"	Sterile	-	Bag of 1	10.50

## GAUZE BANDAGE ROLLS

- Individually wrapped
- Ideal for dressing wounds



Model No.	Mfg No.	Description	Qty	Price /Each
SGB086	FAGB015	1" x 5 yards	1 unit	0.59
SGB087	FAGB015B4	1" x 5 yards	Box of 4	3.28
SGB100	FAGB110	1" x 10 yards	1 unit	0.84
SGB088	FAGB025	2" x 5 yards	1 unit	0.78
SGB089	FAGB025B2	2" x 5 yards	Box of 2	2.88
SGB101	FAGB210	2" x 10 yards	1 unit	1.26
SGB090	FAGB035	3" x 5 yards	1 unit	0.92
SGB091	FAGB035B2	3" x 5 yards	Box of 2	3.34
SGB102	FAGB310	3" x 10 yards	1 unit	1.57
SGB092	FAGB045	4" x 5 yards	1 unit	1.26
SGB093	FAGB045B2	4" x 5 yards	Box of 2	4.17
SGB103	FAGB410	4" x 10 yards	1 unit	1.78

## COMPRESS BANDAGES

- Ideal to stop bleeding without the use of separate gauze pads and bandage rolls
- Includes a non-adherent pad and stretch tails
- Sterile



Model No.	Mfg No.	Dimensions	Qty	Price /Each
<b>ELASTICIZED COMPRESS BANDAGES</b>				
SGA790	FACB4565	4 1/2" x 6 1/2"	Pack of 1	2.32
<b>GAUZE COMPRESS</b>				
SGB106	FAGC36	36" x 36"	Pack of 1	2.17
<b>COMPRESS BANDAGES</b>				
SGA781	FACB002	2"	Bag of 1	1.05
SGA783	FACB002B4	2"	Box of 4	5.07
SGA784	FACB003	3"	Bag of 1	1.03
SGA785	FACB003B	3"	Box of 1	2.19
SGA786	FACB004	4"	Bag of 1	1.26
SGA787	FACB004B	4"	Box of 1	2.96
SGA788	FACB006	6"	Bag of 1	1.67
SGA789	FACB006B	6"	Box of 1	3.51
SAY372	FAPD004	4" x 4"	Bag of 1	3.76
SGB203	FACB55X15	15" x 5 1/2"	Bag of 1	3.34
<b>NON-ADHERENT PAD</b>				
SGB345	FATF2X3	2" x 3"	Box of 100	21.80
SGB346	FATF3X4	3" x 4"	Box of 100	35.50

## COMPRESS BANDAGES

- Ideal to stop bleeding without the use of separate gauze pads and bandage rolls
- Includes a non-adherent pad and stretch tails
- Sterile



Model No.	Mfg No.	Dimensions	Qty	Price /Each
<b>AUTO-ADHESIVE GAUZE BANDAGES</b>				
SGB094	FACFB02	2" x 5 yards	Bag of 12	6.14
SGB095	FACFB02B	2" x 5 yards	1 unit	0.57
SGB096	FACFB03	3" x 5 yards	Bag of 12	8.51
SGB097	FACFB03B	3" x 5 yards	1 unit	0.84
SGB098	FACFB04	4" x 5 yards	Bag of 12	11.60
SGB099	FACFB04B	4" x 5 yards	1 unit	0.94
SGB115	FACFB06	6" x 5 yards	Bag of 12	7.01
SGB116	FACFB06B	6" x 5 yards	1 unit	1.15
<b>ABDOMINAL PAD</b>				
SGD190	FAAP5X9	5" x 9"	Bag of 1	0.80
SGD191	FAAP8X10	8" x 10"	Bag of 1	1.03



# FIRST AID & MEDICAL EQUIPMENT

## BANDAGES DISPENSERS & REFILLS

- Bandage dispenser created for the industrial market, these dispensers are colour coded and contain 4 different types of fabric bandages
- Great in work areas where an easy access to bandages is required
- There are 2 kinds of dispensers available: red for regular industrial use and blue for the food industry, or any other type of industry that requires detectable bandages
- Dispenser and bandages are colour coded
- Prevent loss of times by searching in a first aid kits
- Easy to install and to use



Model No.	Mfg No.	Includes	Price /Each
<b>BANDAGE DISPENSERS</b>			
SGA816	FADISPR	1 jet of adhesive fabric strips (24 of 3" x 3/4" and 16 of 3" x 1") 1 jet of fabric adhesive knuckle strips (16 of 3" x 1-1/2") and 1 jet of fabric adhesive finger tips (16 of 3" x 1-3/4")	32.10
SGA817	FADISPB	1 jet of blue metal detectable fabric strips (24 of 3" x 3/4" and 16 of 3" x 1") 1 jet of blue metal detectable fabric knuckle strips (16 of 3" x 1-1/2") 1 jet of blue metal detectable fabric finger tips (16 of 3" x 1-3/4")	33.80
<b>ADHESIVE FABRIC BANDAGES REFILLS</b>			
SGA815	FADR01/6	Box of 6 jets of adhesive fabric strips (24 of 3" x 3/4" and 16 of 3" x 1")	45.50
SGA813	FADR02/6	Box of 6 jets of adhesive fabric finger tips (16 of 3" x 1-3/4")	33.00
SGA814	FADR03/6	Box of 6 jets of adhesives fabric knuckle strips (16 of 3" x 1-1/2")	33.90
<b>BLUE DETECTABLE FABRIC BANDAGES REFILLS</b>			
SGA812	FADB04/6	Box of 6 jets of blue metal detectable fabric adhesive strips (24 of 3" x 3/4" and 16 of 3" x 1")	56.00
SGA810	FADB05/6	Box of 6 jets of blue metal detectable fabric adhesive finger tips (16 of 3" x 1-3/4")	45.00
SGA811	FADB06/6	Box of 6 jets of blue metal detectable fabric adhesive knuckle (16 of 3" x 1 1/2")	41.80

## MICROPORE™ HYPOALLERGENIC SURGICAL TAPE

- Lightweight, gentle, breathable hypoallergenic paper tape
- Excellent for repeated applications on sensitive skin, fragile skin
- Hold well on damp skin
- 1" x 10 yds
- 12 rolls/box

Model No. SD953  
Mfg. No. 1530-1  
Price/Each \$1.17



## TRANSPORE™ SURGICAL PLASTIC TAPE

- A strong, reliable plastic tape that's specially designed for holding thicker dressings and tubings in place
- Transparent to allow for easy monitoring of wound condition
- Perforated for easier, bi-directional tear
- Easy to handle while wearing gloves
- Hypoallergenic
- 1" x 10 yds
- 12 rolls/box

Model No. SN770  
Mfg. No. 1527-1  
Price/Each \$20.76



## COBAN™ SELF-ADHERENT WRAPS

- Rubber-based, porous self-adhering wraps designed for compression, tension and support without clips, pins or tape
- Will not stick to skin or dressings
- Lightweight and comfortable
- Can be cut to size
- Rolls are 5 yds in length when stretched
- **Applications:** Supporting strains and sprains; wrapping splints; holding and protecting primary and compression dressings



Model No.	Mfg. No.	Width"	Price /Each
SN461	1581	1	1.95
SD907	1582	2	4.00
SD908	1583	3	4.67
SD909	1584	4	6.20
<b>LATEX-FREE</b>			
SDP587	7000128760	1	2.13
SDP588	7000128761	2	4.89
SDP589	7000128762	3	5.37
SDP590	7000128763	4	6.78

## MICROPORE™ S SURGICAL TAPE

- Multi-purpose tape for general securement applications
- Good initial and long term adhesion for up to 48 hours
- Offers repositionable adhesion
- Removes cleanly to help prevent Medical Adhesive-Related Skin Injury (MARS)
- Can be torn, applied, and repositioned by hand
- Ideal for patients with sensitive skin

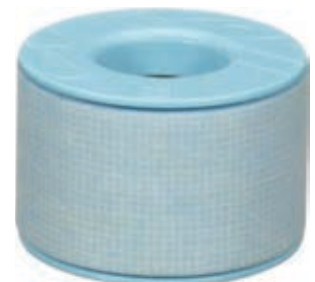

Model No.	Mfg. No.	Dimensions			Price /Each
		W"	x	L'	
SGR798	2770-1	1	x	16-1/2	6.78

## ADHESIVE FABRIC BANDAGES

- Designed to cushion wounds and offer protection against contamination and infection
- For minor cuts, scrapes, abrasions, and burns
- Sterile



SGA704



SGA700



SGA929



Model No.	Mfg No.	Size	Qty	Price /Each
<b>SQUARE</b>				
SGA700	FAFS15X15100	1 1/2" x 1 1/2"	Pack of 100	16.00
SGA701	FAFS15X25100	1 1/2" x 2 1/2"	Pack of 100	24.90
SGA693	FAFS2X350	2" x 3"	Pack of 50	17.10
SGA692	FAFS2X3100	2" x 3"	Pack of 100	29.30
SGA691	FAFSAS100	Assorted sizes	Pack of 100	24.60
<b>STRIPS</b>				
SGA929	FAFS343100	3/4" x 3"	Pack of 100	16.80
SGA932	FAFS7835M	7/8" x 3"	Pack of 5000	383.00
SGA930	FAFS1X3100	1" x 3"	Pack of 100	12.80
SGA694	FAFSASS100	Assorted	Pack of 100	15.10
<b>FINGER &amp; KNUCKLE TIPS</b>				
SGA705	FAFS006B12	Small	Box of 12	3.55
SGA704	FAFS006100	Small	Box of 100	17.00
SGA708	FAFS005B12	Standard	Box of 12	3.98
SGA707	FAFS00550	Standard	Box of 50	9.71
SGA706	FAFS005100	Standard	Box of 100	16.60
SGA703	FAFS007B12	Large	Box of 12	4.23
SGA702	FAFS007100	Large	Box of 100	15.70

## ADHESIVE PLASTIC STRIPS

- Sterile
- Designed to cushion wounds and offer protection against contamination and infection
- For minor cuts, scrapes, abrasions, and burns
- Water-resistant

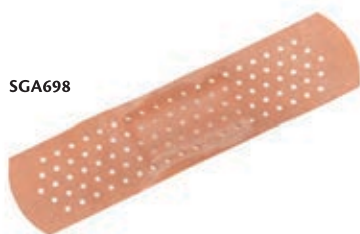

SGA698



Model No.	Mfg No.	Size	Qty	Price /Each
SGA697	FAPS34X3B12	3/4" x 3"	Pack of 12	2.30
SGA698	FAPS34X3B25	3/4" x 3"	Pack of 25	3.67
SGA699	FAPS34X3B50	3/4" x 3"	Pack of 50	5.30
SGA710	FAPS34X3100	3/4" x 3"	Pack of 100	7.46
SGA712	FAPS1X3B16	1" x 3"	Pack of 16	3.42
SGA713	FAPS1X3B25	1" x 3"	Pack of 25	3.67
SGA714	FAPS1X3B50	1" x 3"	Pack of 50	6.32
SGA711	FAPS1X3100	1" x 3"	Pack of 100	8.38

## BLUE METAL DETECTABLE ADHESIVE FABRIC BANDAGES

- Sterile
- Designed to cushion wounds and offer protection against contamination and infection
- For minor cuts, scrapes, abrasions, and burns
- Bright blue colour and metallic content allow for misplaced or lost bandages to be easily detected and retrieved



SGA696



Model No.	Mfg No.	Type	Size	Qty	Price /Each
SGA696	FAFSD005	Knuckle sterile	3/4" x 3"	Box of 100	30.60
SGA695	FAFSD006	Finger tips Dressing sterile	Large	Box of 100	38.10

## SKIN CLOSURES

- Sterile
- Designed to hold wounds together, support sutures (stitches), or provide post-surgical support after the removal of sutures



SGA778



Model No.	Mfg No.	Size	Qty	Price /Each
<b>STRIP</b>				
SGE729	FACS18X3	1/8" x 3"	Pack of 5 units	4.17
SGE730	FACS14X3	1/4" x 3"	Pack of 3 units	3.98
<b>BUTTERFLY</b>				
SGA778	FABFM100	Medium	Box of 100	18.90
SGA777	FABFL100	Large	Box of 100	13.80
SGA776	FABFAS10	Assorted	Box of 10	3.61

## ADHESIVE REMOVER SACHETS

- Softens adhesive on tapes and adhesive bandages to minimize discomfort caused by adhesive removal
- Removes adhesive/tape residue from skin without irritation



Model No.	Mfg No.	Qty	Price /Each
SGE773	FAA1BAR	Box of 100	16.30

# FIRST AID & MEDICAL EQUIPMENT

## HYDROGEN PEROXIDE

- Used as a cleaning agent for wounds and cuts



Model No.	Mfg No.	Size	Price /Each
SGC789	FAHP115	100 ml	3.34
SGD225	FAHP225	250 ml	4.84
SGD226	FAHP400	500 ml	6.88
SGE725	FAHP4L	4 L	52.70

## SOAP

- For use as a scrub, detergent, and cleansing agent



Model No.	Mfg No.	Type	Size	Price /Each
SEE682	FAGS50	Liquid	60 ml	4.38
SGB124	FAGS250	Liquid	250 ml	7.82
SAY438	FAGS500	Liquid	500 ml	11.60
SEA816	FAGS4L	Liquid	4 L	62.70
SGB316	FASB	Bar	0.42 oz.	0.46

## RUBBING ALCOHOL

- For use as an antiseptic and anti-bacterial agent
- 70% alcohol



Model No.	Mfg No.	Size	Price /Each
SGD237	FARB225	250 ml	6.90
SGB291	FARB500	500 ml	10.60
SGD238	FARB4L	4 L	64.10

## HAND CLEANING TOWELETTES

- For cleansing skin and minor wounds



Model No.	Mfg No.	Qty	Price /Each
SGB129	FAHCMT10	Pack of 10	2.99
SGB128	FAHCMT	Pack of 100	10.40

## ALCOHOL WIPES

- For cleansing skin and minor wounds



Model No.	Mfg No.	Qty	Price /Each
SGD192	FAAW10	Box of 10	3.36
SGE726	FAAW100	Box of 100	5.67
SGC781	FAAW200	Box of 200	10.10

## OZONOL OINTMENT

- Provides fast relief of pain and itching associated with cuts, scrapes, minor burns, insect bites, chafing and chapping
- Non-stinging formula



Model No.	Mfg No.	Description	Price /Each
SAY446	FA357685	ozonol ointment 30 g	29.80

## CETRIMIDE ANTISEPTIC

- Provides fast relief of pain and itching associated with cuts, scrapes, minor burns, insect bites, chafing and chapping
- Non-stinging formula



Model No.	Mfg No.	Type	Size	Price /Each
SAY441	FACM025	Cream	25 g	4.80

## POLYSPORIN

- Prevents infection and aids in the healing of minor cuts, scratches, scrapes and abrasions
- Soothing ointment forms a protective coating
- Non-stinging
- Odourless



Model No.	Mfg No.	Size	Price /Each
SAY444	FAB004864	15 g	22.90
SGC665	FA004865	30 g	38.20

## BENZALKONIUM ANTISEPTIC TOWELETTES

- For cleansing skin and minor wounds
- Sting-free for sensitive skin



Model No.	Mfg No.	Qty	Price /Each
SGA741	FABZ002B10	Pack of 10	6.45
SGA740	FABZ002	Pack of 100	10.10



# FIRST AID & MEDICAL EQUIPMENT

## INSTA-GLUCOSE® ORAL GEL

- Concentrated sugar in gel form for oral treatment of insulin shock
- Each single-dose tube delivers 24 g of carbohydrates
- Gel formula is easy to swallow without chewing
- Provides a rapid increase in blood sugar concentration



Model No.	Mfg No.	Size	Price /Each
SAY582	FAG125	31 g	25.10

## LIP BALM

- Prevents and heals dry, chapped and sun-wind burned lips

SGA737



SGB166



Model No.	Mfg No.	Description	SPF	Price /Each
SGB166	FA047114	Lypstyl lip balm	-	4.03
SAY511	FABL4	Blistex lip balm	15	4.28
SGA737	FABLS30	Blistex lip balm	30	10.20

## HAND CREAM

- Relief and protection for dry, chapped hands

SGB172



Model No.	Mfg No.	Description	Size	Price /Each
SGB172	FA132702	Neutrogena hand cream	50 ml	23.20

## BAKING SODA

- Baking soda counteracts the acids and venom of many insect bites
- Can draw excess pus from a wound and other contaminants in the skin
- Absorbs odours



Model No.	Mfg No.	Size	Price /Each
SGA735	FA300130	250 g	3.32

## SOOTHE & COOL BODY POWDER

- Made with natural cornstarch
- Absorbs moisture and odor
- Goes on soft and rinses off easily



Model No.	Mfg No.	Size	Price /Each
JN612	MSC095392	395 g	7.86

## BACTINE® FIRST AID SPRAY

- Antiseptic and pain relieving spray
- For treatment of sunburn, minor cuts, burns, scratches, insect bites, and poison ivy
- Kills germs, relieves pain and itch
- Non-stinging formula



Model No.	Mfg No.	Size	Price /Each
SAY436	FA002009	105 ml	22.60

## TABLETS

- Neutralizes stomach acidity to relieve discomfort caused by heartburn, indigestion or upset stomach



Model No.	Mfg No.	Description	Price /Each
SAY501	FA633739	Pepto Bismol® chew tabs - bottle of 24	21.90

## HEAT TREATMENT

- Topical cream used for temporary relief of muscle or joint pain caused by strains, sprains, arthritis, bruising, or backaches

SGE802



Model No.	Mfg No.	Description	Size	Price /Each
SGE802	FA369837	A-535 rub	100 g	32.50

## STING RELIEF SACHETS

- Used to relieve discomfort caused by insect stings and bites

SGE738



Model No.	Mfg No.	Qty	Price /Each
SGE738	FASRU10	Box of 10	4.86
SGE739	FASR100	Box of 100	30.20

## FOOT POWDER

- Keeps feet dry and odour-free
- Absorbs perspiration and wetness



Model No.	Mfg No.	Size	Price /Each
SGD235	FAPA50	50 g	5.59

# FIRST AID & MEDICAL EQUIPMENT

## FIRST AID FORCEPS

- Ideal for removing embedded objects, manipulating dressings, and more



Model No.	Mfg No.	Material	Description	Length"	Price /Each
SGB323	FATW045	Nickel Plated	Splinter Forceps, straight	4 1/2	2.57
SGB200	FATWP01	Plastic	Tweezers	4 1/2	0.63
SGA819	FATWP210	Metal	Dressing Forceps	4 3/4	2.98
SGA820	FATWP214	Metal	Dressing Forceps	5 1/2	3.42
SGB325	FATWP332	Metal	Splinter Forceps Feilchenfeld	4 3/4	3.36
SGB322	FATW3M	Metal	Splinter Forceps With Magnifier	3 3/4	6.13
SGB082	FATWP410	Metal	Forceps Mosquito Halstead	5	5.96
SGB083	FATWP442	Metal	Forceps Rochester-Pean	5 1/2	6.59
SGB362	FATW001	-	Tweezers Economy kit	-	0.82

## FIRST AID SCISSORS

- Used to cut bandages, gauze, clothing, etc. in an emergency first aid situation

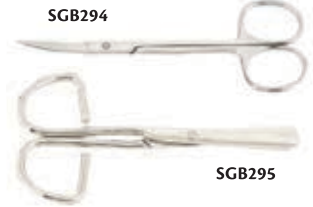

Model No.	Mfg No.	Description	Length"	Price /Each
SGB182	FASC55G	Paramedic Scissors	5 1/2	2.57
SGB183	FASC75B	Paramedic Scissors	7	5.78
SGB163	FASC35L	Lister Bandage Scissors	3 1/2	4.05
SGB164	FASC45L	Lister Bandage Scissors	4 1/2	4.30
SGB165	FASC55L	Lister Bandage Scissors	5 1/2	4.55
SGB298	FASCP44	Scissors O.R. sharp/blunt	5 1/2	4.46
SGB297	FASCP42	Scissors O.R. sharp/sharp	5 1/2	4.46
SGB296	FASCP30	Scissors O.R. blunt/blunt	4 1/2	4.05
SGB299	FASCP118	Scissors straight iris	4 1/2	2.57
SGB294	FASCP120	Scissors curved iris	4 1/2	2.61
SGB295	FASC001	Scissors economy kit	-	1.03

## SPLINTER OUT

- Designed to enable removal of splinters with minimal discomfort



Model No.	Mfg No.	Description	Price /Each
SAY542	FASPO20	Splinter out - box of 20	9.78

## SAFETY PINS

- Used to secure bandages



Model No.	Mfg No.	Description	Price /Each
SAY543	FASPO12	Pack of 12	0.67

## FIRST AID INSTRUMENT KIT

- Includes: 1 kit scissors, 1 tweezers, 1 set of assorted safety pins



Model No.	Mfg No.	Price /Each
SGB146	FAIK	4.30

## RING CUTTER

- Provides fast response when emergency ring removal is required
- Easy-to-use cutter relieves pain and helps lessen further damage to fingers



Model No.	Mfg No.	Description	Price /Each
SEL322	FARC182	Ring cutter	22.30

## EYE LOOP

- Used to remove unwanted particles from the eye with minimal intrusion
- Eye loop and magnet for removal of metallic and non-metallic objects



Model No.	Mfg No.	Price /Each
SGA868	FAA19900	13.80

## FIRST AID BASINS

- Multipurpose basins for oral hygiene, patient sickness and treatment, and soaking
- Stainless Steel



SGB156



Model No.	Mfg No.	Type	Size	Price /Each
SGB376	FAWB123	Wash Basin	-	69.60
SGB155	FAKB2000	Kidney Basin	15 cm	14.40
SGB156	FAKB2010	Kidney Basin	22 cm	17.00
SGB157	FAKB2020	Kidney Basin	25 cm	21.00

## SHARPS® CONTAINER

- Secure, easy-to-use container offers safe disposal of sharp instruments



SGB309



Model No.	Mfg No.	Description	Price /Each
SGB307	FACS3LT	Sharps® container 3 L - for syringe disposal	10.90
SGB309	FACS7LT	Sharps® container 7 L - for syringe disposals	16.60
SGE753	FA8967Y	Multi-Purpose Sharps® Container with horizontal drop opening lid 2 gal/7.6 L	40.60
SGB381	FA8975	Wall Bracket for Sharps® container SGE753	56.10
SGB194	FA8900SA	Phlebotomy (Blood drawing) Sharps® Container Covidien 1 qt./1 L	9.13

## BIOMEDICAL SHARPS DISPOSAL INTERNAL CONTAINER

- Internal container designed and certified to exceed penetration requirements for all applicable international standards
- Capacity: 4 L
- Material: Plastic
- Colour: Yellow
- 5-1/2" L x 5-1/2" W x 12" H
- Priced per case of 4



Model No.	Mfg No.	Price /Each
JM060	878-500	109.00

## SHARPS CONTAINER

- Allows for safe disposal of sharp objects
- Leak-proof and puncture resistant
- Temporary and definite closure
- Built-in needle removal
- Capacity: 1 L
- Dimensions: 11 cm X 10 cm X 15.5 cm



Model No.	Mfg No.	Price /Each
SGW112		5.45

## CPR MASK

- C.P.R. mask with one way valve and oxygen inlet in plastic container



Model No.	Mfg No.	Price /Each
SGA792	FACPRM	16.80

## AIRWAY KIT

- For use on an unconscious patient to maintain an airway, suction fluids and depress a victim's tongue to prevent airway blockage
- Bite locks are colour-coded for quick identification according to universally established standards



Model No.	Mfg No.	Container Type	Price /Each
SGA724	FAAIR	Nylon bag	18.00

## DISPOSABLE MANUAL RESUSCITATOR

- Single-use physical protection barrier to prevent the victim's breath and bodily fluids from reaching the rescuer



Model No.	Mfg No.	Size	Price /Each
SGA809	FAQMR9000	Adult	85.90

## BIOMEDICAL SHARPS DISPOSAL UNIT

- Perfect for health care & commercial settings such as hospitals, long term care facilities, doctor & dentist offices, schools, airports, & more
- Front loading for easy service and maintenance
- A heavy-duty vandal resistant design to ensure medical waste is safely protected
- Screened on graphics in English, French, and Spanish
- Top features a steel recessed tube inlet to prevent unauthorized access
- Suitable for discarding needles, syringes, blades, pins, gauze, and cotton balls
- Internal container designed and certified to exceed penetration requirements for all applicable international standards
- Comes complete with a standard 4 litre (4.23 qt) plastic disposable sharps container (replacements sold separately)
- Material: Stainless Steel
- Finish: Brushed
- 5.9" L x 7.75" W x 14.38" H



Model No.	Mfg No.	Price /Each
JM059	878	285.00

## DISPOSABLE RESCUE BREATHER

- Single-use physical protection barrier to prevent the victim's breath and bodily fluids from reaching the rescuer



Model No.	Mfg No.	Container Type	Price /Each
SGB274	FARB	Ziplock bag	2.05

## MANUAL SUCTION UNIT

- Ideal for suctioning vomit and fluids from the patient's airway

SGB167



Model No.	Mfg No.	Description	Price /Each
SGB167	FAMSU	Manual suction unit	139.00
SGB270	FAMSURC	Replacement cartridges for manual suction unit	57.50

## CPR KITS

- Designed to assist in emergency response to fatal breathing situations
- Reduces the risk of transferring viruses and infections while administering CPR

SGA806



Model No.	Mfg No.	Includes	Price /Each
SGA806	FAKDRESP	(1) small nylon bag, (1) rescue breather SGB274	12.50
SGA807	FAKDRESP1	(1) small nylon bag and (1) rescue breather SGB274, (2) antiseptic wipes, (1) pair of disposable gloves	18.60
SGA808	FAKDRESP3	(1) medium nylon bag with belt loop, (1) rescue breather SGA792, (2) antiseptic sachet, (1) pair of disposable gloves	26.80



# FIRST AID & MEDICAL EQUIPMENT

## ICE BAG

- Constructed of two layers, the outer layer is made from a woven cotton/polyester fabric, which allows for gentle contact against skin
- A second layer made of a rubberized lining prevents leakage
- The lid has deep threads and a rubber gasket to protect against leakage
- Dimensions: 8" dia.



### BIOS living

Model No.	Mfg No.	Description	Price /Each
SGC254	57009	Reusable	10.99

## HEATING PADS

- Adjustable heating pad with 4 heat settings
- 2 hour auto shut-off
- LED control makes it easy to switch heat settings
- Pad is contained in a soft, plush cover
- 9' power cord allows for convenient access to the nearest power outlet
- Cold/Hot: Hot
- Reusable: Reusable



### BIOS living

Model No.	Mfg No.	Dimensions			Price /Each
		W"	x	L"	
SGC243	57064	24	x	12	44.99
SGS414	57065	15	x	12	39.99

## HEAVY DUTY REACH & GRIP

- Pick up small and large items securely with minimal finger flexing
- Extra-wide jaws with suction cups have a strong hold on objects
- Lightweight heavy duty aluminum shaft and an ergonomic handle for easy use
- Perfect for seniors, people with Arthritis, Motor Neurone Disease or post-operative



### BIOS living

Model No.	Mfg No.	Overall Length"	Price /Each
SGC248	57045	34	30.99

## CRUTCHES

- Durable aluminum construction
- Includes pads and tips
- Available in two sizes



### BIOS living

Model No.	Description	Price /Each
SEG990	Adult Medium – 157 to 178 cm	44.99
SEG991	Adult Large – 178 to 198 cm	44.99

## OFFSET CANES

- Made from lightweight aluminum
- Ergonomic offset handle
- Comfortable to use and reduces stress on hands and wrist
- This functional cane is adjustable in height
- Height: 31" - 39"
- Weight Capacity: 300 lbs.

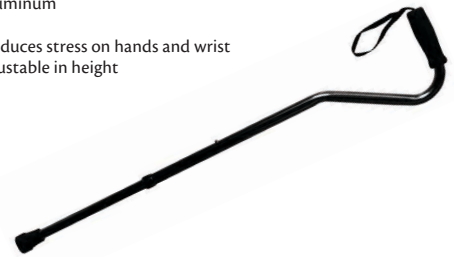

### BIOS living

Model No.	Mfg No.	Colour	Price /Each
SGC246	56015	Black	21.99
SGS413	BD780	Blue	21.99

## TRANSPORT CHAIR

- Stain resistant, easy clean armrests and seat
- Hand strap and leg band provide added security during transport
- Standard seat belt
- Detachable footrests provide leg clearance
- 8" front and rear MAG wheels provide effortless motion



### BIOS living

Model No.	Mfg No.	Price /Each
SGC245	56053	279.00

## WHEELCHAIR

- Weight Capacity: 300 lbs (136 kg)
- Steel framed folding wheelchair with removable foot rests, full length fixed arms, solid tires, and embossed lightweight vinyl upholstery
- Can be propelled by the user or pushed by a caregiver
- Rear storage pocket
- 8" front tires, 24" MAG rear wheels



### BIOS living

Model No.	Mfg No.	Price /Each
SF1907	56084	365.00

# FIRST AID & MEDICAL EQUIPMENT

## ROLL AWAY COT

- Ideal to accommodate overnight guests



Model No.	Mfg No.	Includes	Price /Each
SGB290	FAROLACOT	Frame and mattress	524.00

## TREATMENT CHAIR

- Provides patient comfort and facilitates treatment
- Features a treatment basin holder



Model No.	Mfg No.	Price /Each
SAV624	FACTREAT	1103.00

## ALBAC MAT RESCUE STRETCHER

- Safe, Light & Fast to Use
- Less than 5 lbs. & Store Easily
- Can Hold Over 800 lbs
- Can be operated by one person

SGA725



Model No.	Mfg No.	Description	Price /Each
SGA726	FAALBS	Albac Mat rescue - standard size	1371.00
SGA725	FAALBL	Albac Mat rescue - large size	1390.00
SGA756	FAALBHL	Wall Bracket for the Albac Mat - holds 4 units	380.00

## EMERGENCY RESCUE BLANKETS

- For use in case of emergency

SGB365



SGA835



Model No.	Mfg No.	Description	Price /Each
SGB273	FAAB001	Emergency rescue blanket - Silver made of mylar with body heat	2.36
SGA835	FABDY	Yellow polyethylene emergency blanket (54" x 80")	11.10
SGB365	FAUSBG	Utility stretcher blanket grey mixed fibers polyester (60" x 80")	19.50
SGB066	FABFB00	Fire blanket 100% wool with nylon pouch holder	65.20
SGB067	FASABL	Fire blanket pouch only	17.80
SGA836	FABBL3	3 emergency rescue blanket in plastic bag	116.00

## SPINAL BOARDS

- Patient handling device used in trauma care
- Designed to provide support during movement of a person with suspected injuries



SGB084



Model No.	Mfg No.	Description	Price /Each
SGB084	FASB01	Full wood spinal board	478.00
SGB199	FASBP01	Spinal board plastic 16"	315.00
SGB085	FASB01WS	Full wood spinal board with 3 straps	492.00
SGB198	FASBP01WS	Full plastic spinal board in yellow with 3 straps	328.00

## STRETCHERS

- Used for moving patients who require medical care



SAY592

SGD252



Model No.	Mfg No.	Description	Price /Each
SFW469	FATRA110125A	Advantage basket stretcher	3726.00
SFW470	FAYJBL001	Yellow jacket basket stretcher complete with straps	4759.00
SAY592	FAFSA	Aluminium double folding stretcher	200.00
SAY591	FAFSB	Aluminium single folding stretcher	178.00
SGB329	FASAMB01	Ambulance type stretcher	1964.00
SGE756	FASSCOOP1	Stretcher scoop	498.00
SGB330	FABASKP1	Stretcher basket plastic	2079.00

## STRETCHER ACCESSORIES

- For use with stretchers in case of emergency rescue



SGB334

SGA757



Model No.	Mfg No.	Description	Price /Each
SGB334	FASSPB4	Straps stretcher with plastic buckle 4 ft.	17.30
SGB335	FASSPB6	Straps stretcher with plastic buckle 6 ft.	16.30
SAV598	FASSMB5	Straps stretcher with plastic buckle 6 ft. - set of 3	71.40
SAV597	FASSV3	Straps for stretcher or backboard - set of 3 with fast-stick closure	30.20
SAV604	FAMWB	Mattress for basket stretcher	167.00
SGA757	FABWB	Bridle for wire basket stretcher	230.00
SGA723	FABWBA	Adjustable bridle for wire basket stretcher	250.00

# FIRST AID & MEDICAL EQUIPMENT

## HEAD IMMOBILIZER

- One size fits all
- Immobilization device for use with an extrication collar when head or neck injuries are suspected

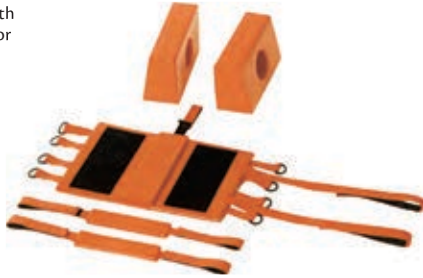

Model No.	Mfg No.	Price /Each
SAV596	FASUHI	190.00

## FAST STRAP SPIDER

- Quick restraint system designed to quickly secure patients to backboards and other devices for rapid patient immobilization and extraction

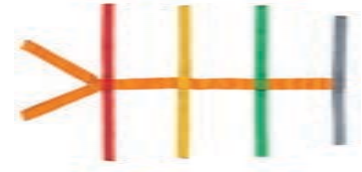

Model No.	Mfg No.	Price /Each
SGB057	FASPIDER	68.30

## EXTRICATION DEVICE

- Used to immobilize and support the spine, neck, and head, allowing for safe extrication from vehicles and other confined spaces



Model No.	Mfg No.	Price /Each
SGA864	FASED01	283.00

## BIOHAZARD WASTE CONTAINERS

- Meets OSHA regulations for the segregation of infectious waste, ensuring proper disposal
- May be used for the temporary storage of contaminated laundry as well as regulated waste, such as semi-liquid blood or other potentially infectious materials
- Leak-proof, sturdy metal construction with foot-operated self-closing lid reducing the risk of contamination
- Ideal for hospitals, clinics, doctors and dentists office, nursing homes and many industrial facilities
- OSHA 29CFR 1910.1030
- FM approved



Model No.	Mfg No.	Capacity	Dimensions O.D." x H"	Price /Each
SD500	05910	6 gal	11-7/8 x 15-7/8	245.00
SD502	05901	Replacement bags		79.00

## EVACUATION CHAIR

- Designed for use in an emergency evacuation to enable victims to ride down the stairs
- Used to transport wheelchair users, less able-bodied people, or injured and disabled people safely and quickly up and down stairways to safety



SGA857



Model No.	Mfg No.	Description	Price /Each
SGA856	FAEVAC300H	EVAC+Chair 300H	5229.00
SGA857	FAEVAC600H	EVAC+CHAIR 600H	5543.00
SGA858	FAEVAC700H	EVAC+CHAIR 700H	8109.00

## SURE-GUARD™ BIO-MEDICAL WASTE LINERS

- Premium bio-hazard waste removal
- Printed with bold **BIO-MEDICAL WASTE**
- Constructed specifically for the safe containment and transport of infectious waste
- Noticeably more tough and puncture resistant than normal liners due to Sure-Guard™ liners being made with high grade virgin resins
- Can handle the toughest abatement, restoration, environmental and industrial applications
- Sure-Tie® drawstring closure available for ultimate personal protection and waste containment
- Ideal for industrial/commercial facilities, hospitals, ambulances, nursing homes, schools, transportation vehicles, correctional facilities, laboratories, medical and dental offices



JD099

Priced per Case

Model No.	Size"	Colour	Qty /Case	Price /Each
JD099	21.5 x 29	Yellow	200	89.60
JD100	30 x 38	Red	100	75.70
JD101	30 x 38	Yellow	100	78.50
JD102	37 x 50	Red	100	108.00
JD103	39 x 46	Yellow	100	111.00
JD104	55 x 74	Yellow	50	146.00



## PURELL® ADVANCED HAND RUB

- Purell® in a 70% ethyl alcohol, fragrance-free antiseptic cleanser
- Effective in destroying certain bacteria
- Contains vitamin E and glycerine



Model No.	Mfg. No.	Description	Price /Each
SAR855	5770-04-CAN00	1200 ml Touchfree TFX™ Refill	44.50
SAR854	2770-08-CAN00	1000 ml NXT® Refill	24.90
SAR856	9770-12-CAN00	354 ml Pump Bottle	12.50
SBA838	5395-02-CAN00	1200 ml Touchfree TFX™ Foam Refil	93.50

## GERMXTRA HARD SURFACE DISINFECTANT

- A rapid ready-to-use, broad spectrum disinfectant spray
- GermXtra is a tuberculocidal disinfectant containing a synergistic combination of ethanol and surfactants, killing TB in 1 minute
- Fine aerosol mist ensures effective penetration of fibrous materials, cracks and crevices



Model No.	Size	Scent	Price /Each
JB414	4 L	Garden Mint	129.00
JB416	4 L	Lemon	129.00

## RESPIRATORS & PPE CLEANING TOWELETTES

- 5" x 8" individually wrapped towelettes
- 100 towelettes per box
- For rubber or latex face and mouth pieces, respirators, etc.
- Alcohol-free
- Avoids "drying-out" associated with alcohol based cleaners

Model No. SEE383  
Price/Each \$14.15



## QUAT PLUS – DISINFECTANTS & CLEANERS

- A disinfectant and germicidal detergent
- Eliminates malodour by destroying a wide range of bacteria, fungicide and viruses
- Effective against influenza A (H<sub>1</sub>N<sub>1</sub>)
- D.I.N. #02298694
- Certified UL ECOLOGO® 2794
- 4 L

Model No. JD491  
Mfg. No. 50232  
Price/Each \$36.50



## ULTRA SWIPES

- Disposable cloths clean, disinfect and deodorize hard surfaces and instruments
- Ethanol formulation provides hospital-level disinfection to destroy a wide range of pathogens, including HIV-1 (AIDS) and TB in just 1 minute
- 160 sheets per canister

Model No. JA984  
Price/Each \$40.50



## SUPER CONCENTRATED SANITIZERS & DEODORIZERS

- Specially formulated to sanitise and deodorize pre-cleaned hard surfaces
- Excellent for use in restaurants, dairies, food processing plants and bars
- Effective sanitiser against Escherichia coli, Yersinia enterocolitica, Staphylococcus aureus and E. coli O157:H7
- No rinse
- Accepted for use in Canadian food processing facilities  
D.I.N. #02248470
- 4 L

Model No. JD028  
Price/Each \$38.50



# LOCKS

## AMERICAN LOCK HIDDEN SHACKLE PADLOCKS & MASTER LOCK HIGH SECURITY HASPS (REKEYABLE)

The hockey puck-style lock design completely surrounds the 3/8" dia. shackle for high-security pry and cut resistance. Our industrial-strength padlocks are keyable and have replaceable cylinders and shackles.

- These padlocks offer maximum protection against drilling, sawing, prying, crowbar, dent pullers and hammers
- 6-pin tumber cylinders provide superior pick resistance, with tens of thousands of key changes available
- Secure vans, trucks, gates, garages, storage buildings and vending machines
- Locks come with two keys. For keyed alike options and master keying, please call us today
- Combined with high-security hasps (SAO687); designed to completely surround the lock; it make the locks virtually impervious to physical attacks

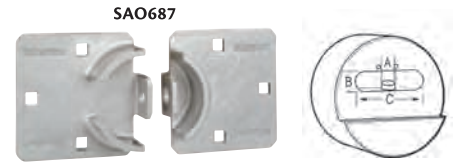

**Master Lock**

Model No.	Mfg. No.	Description	Body Size		Body Material	Shackle Clearance			Shipping Weight (lbs.)	Price /Each
			Width"	Thickness"		A"	B"	C"		
SGC834	A2010	Lock	2 7/8	1 1/4	Steel	3/8	1 9/32	1 23/32	2.20	84.70
SAO687	770	Hasp	9 x 4 1/2	1/4	Steel	N/A	N/A	N/A	3.00	53.40

## SOLID STEEL PADLOCKS (REKEYABLE)

- Constructed of hardened, chrome-plated solid steel bodies that resist cutting, sawing and corrosion
- Hardened boron alloy steel shackles offer superior cut resistances while dual ball bearing locking mechanism resists pulling and prying attacks
- 5-pin Pro Series® cylinders provide tens of thousands of key changes
- Special spool pin tumblers are virtually impossible to pick
- Rekeyable - replaceable cylinder and shackle
- Locks come with two keys
- For keyed alike options and master keying, please call us



**Master Lock**

Model No.	Mfg. No.	Body Size		Body Material	Shackle Clearance			Shipping Weight (lbs.)	Price /Each
		Width"	Thickness"		A"	B"	C"		
SN708	6230	2 1/2 Round	1 1/8	Hardened Steel	7/16	1 1/8	7/8	1.40	68.10
SEJ510	7050	2	1	Hardened Steel	3/8	1 1/2	29/32	0.85	54.00
SAL442	7040	1 3/4	1	Hardened Steel	5/16	1 3/16	29/32	0.75	45.40

## SOLID STEEL SHROUDED PADLOCKS (REKEYABLE)

- Shrouded shackles provide superior resistance to cutting by minimizing shackle exposure to physical attacks



**Master Lock**

Model No.	Mfg. No.	Body Size		Body Material	Shackle Clearance			Shipping Weight (lbs.)	Price /Each
		Width"	Thickness"		A"	B"	C"		
SN707	7045	1 3/4	1	Hardened Steel	5/16	1 3/16	29/32	0.90	83.20
SN715	7035	1 9/16	13/16	Hardened Steel	1/4	1 1/16	25/32	0.80	79.10

## PRO SERIES® SOLID BRASS PADLOCKS (REKEYABLE)

- Solid brass body construction resists corrosion - ideal for harsh environments
- Hardened boron alloy steel shackles offer superior cut resistances while dual ball bearing locking mechanism resists pulling and prying attacks
- 5-pin Pro Series® cylinders provide tens of thousands of key changes
- Special spool pin tumblers are virtually impossible to pick
- Rekeyable - replaceable cylinder and shackle
- Locks come with two keys
- For keyed alike options and master keying, please call us



**Master Lock**

Model No.	Mfg. No.	Body Size		Body Material	Shackle Clearance			Shipping Weight (lbs.)	Price /Each
		Width"	Thickness"		A"	B"	C"		
SAL507	6840	1 3/4	1	Solid Brass	5/16	1 3/16	29/32	0.80	50.20
SAL508	6830	1 9/16	15/16	Solid Brass	1/4	1 1/16	25/32	0.70	42.50

## RESETTABLE BRASS COMBINATION PADLOCKS

- Easy "Set-your-Own" 4-digit combination with up to 10 000 combinations available
- Strong, solid brass case construction resists corrosion - ideal for harsh environments
- Heavy hardened steel shackles provide high resistance to cutting and prying
- Model SEJ513 features a key override providing immediate access to supervisors in the field
- SEJ514 control key sold separately



**Master Lock**

Model No.	Mfg. No.	Body Size		Body Material	Shackle Clearance			Shipping Weight (lbs.)	Price /Each
		Width"	Thickness"		A"	B"	C"		
SAS366	175	2	1	Brass Casing	5/16	1	1	0.60	40.70
SAG162	175LH	2	1	Brass Casing	5/16	2 1/4	1	0.70	46.00
SEJ513	176	2	15/16	Brass Casing	5/16	1	1	0.60	49.00
SEJ514	K176	Control Key		Brass	-	-	-	0.02	8.21

## PROSERIES® RESETTABLE BRASS COMBINATION PADLOCKS

- Easy "Set-your-Own" 4-digit combination with larger ergonomic dials
- Strong, solid brass case construction resists corrosion with weather seal top around shackles
- Boron octogon shackle design increases cut resistance
- No reset tool required. Simple shackle manipulation to change combinations
- LH shackle option available for increased shackle clearance

**Master Lock**

Model No.	Mfg. No.	Body Size		Body Material	Shackle Clearance			Shipping Weight (lbs.)	Price /Each
		Width"	Thickness"		A"	B"	C"		
SEJ515	1175	2 1/4	1 3/16	Brass Casing	3/8	1 1/16	15/16	0.70	50.50
SEJ516	1175LH	2 1/4	1 3/16	Brass Casing	3/8	2	15/16	0.71	55.90



SEJ515

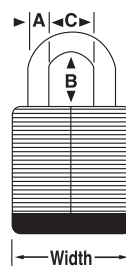

## ECONOMY V-LINE BRASS PADLOCKS (NON-REKEYABLE)

- Solid brass body and cylinder construction resists corrosion - ideal for harsh environments
- Case hardened shackle resists sawing and filing
- Pin tumbler cylinder provides greater pick resistance
- Locks come with two keys. For keyed alike options, please call us

**Master Lock**

Model No.	Mfg. No.	Key Type	Body Size		Body Material	Shackle Clearance			Shipping Weight (lbs.)	Price /Each
			Width"	Thickness"		A"	B"	C"		
SAS395	4120	Different	3/4	3/8	Solid Brass	5/32	7/16	3/8	0.10	6.08
SAS396	4120KA	Alike	3/4	3/8	Solid Brass	5/32	7/16	3/8	0.10	8.00
SAS397	4130	Different	1 1/8	1/2	Solid Brass	3/16	9/16	9/16	0.20	9.12
SAS398	4130KA	Alike	1 1/8	1/2	Solid Brass	3/16	9/16	9/16	0.20	11.00
SAS015	4140	Different	1 1/2	1/2	Solid Brass	1/4	13/16	13/16	0.30	12.30
SAS400	4140KA	Alike	1 1/2	1/2	Solid Brass	1/4	13/16	13/16	0.30	14.10
SAS401	4150	Different	1-7/8	9/16	Solid Brass	9/32	15/16	13/16	0.40	18.60
SAS402	4150KA	Alike	1-7/8	9/16	Solid Brass	9/32	15/16	13/16	0.40	20.20



SAS395

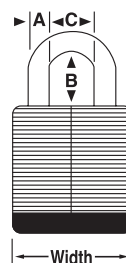

## ALL WEATHER RESISTANT PADLOCKS

The covered padlocks withstand even the harshest outdoor environments and corrosive atmospheres. These locks are excellent in perimeter security, storage buildings, and gate security and transportation.

### PRO SERIES® WEATHER TOUGH™ SECURITY PADLOCKS (REKEYABLE)

- Constructed of hardened, chrome rustproofed steel laminated bodies that resist cutting, sawing and corrosion
- Durable thermal plastic covers protect the body of the lock from dirt, dust and other contaminants
- Hardened boron alloy steel shackles offers superior cut resistances while dual ball bearing locking mechanism resists pulling and prying attacks
- 5-pin Pro Series® cylinders provide tens of thousands of key changes
- Special spool pin tumblers are virtually impossible to pick
- Rekeyable - replaceable cylinder and shackle
- Locks come with two keys
- For keyed alike options and master keying, please call us

**Master Lock**

Model No.	Mfg. No.	Key Type	Body Size		Body Material	Shackle Clearance			Shipping Weight (lbs.)	Price /Each
			Width"	Thickness"		A"	B"	C"		
SAL433	6121	Different	2 1/8	1	Laminated Steel	5/16	1 1/8	7/8	1.00	49.90
SAL434	6121LJ	Different	2 1/8	1	Laminated Steel	5/16	2 1/2	7/8	1.05	53.40
SA902	6125	Different	2 3/8	1 3/16	Laminated Steel	3/8	1 3/8	7/8	1.20	56.30
SA903	6125KA	Alike	2 3/8	1 3/16	Laminated Steel	3/8	1 3/8	7/8	1.20	57.40



SAL433



SA903

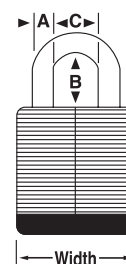

### LAMINATED STEEL SHROUDED PADLOCKS (REKEYABLE)

- The High Security - Weather Tough® padlock's iron shroud protects the shackle from cutting and prying while the heavy-duty laminated steel body construction withstands physical attacks

**Master Lock**

Model No.	Mfg. No.	Key Type	Body Size		Body Material	Shackle Clearance			Shipping Weight (lbs.)	Price /Each
			Width"	Thickness"		A"	B"	C"		
SA904	6325	Different	2 3/8	1 3/16	Laminated Steel	3/8	3/4	7/8	1.60	81.10
SA905	6325KA	Alike	2 3/8	1 3/16	Laminated Steel	3/8	3/4	7/8	1.60	80.80
SEJ517	6321	Different	2 1/8	1	Laminated Steel	5/16	3/4	7/8	1.40	68.50

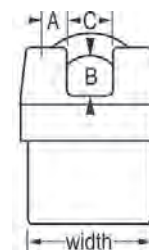

### ECONOMY WEATHER PADLOCKS (NON-REKEYABLE)

- 1 9/16" laminated steel body construction for superior strength
- High-tech thermoplastic shell designed to protect and withstand the elements
- Hardened steel shackle
- Locks come with two keys
- Ideal for all outdoor applications

**Master Lock**

Model No.	Mfg. No.	Key Type	Body Size		Body Material	Shackle Clearance			Shipping Weight (lbs.)	Price /Each
			Width"	Thickness"		A"	B"	C"		
SN706**	312	Different	1 9/16	1 1/8	Laminated Steel	3/8	1	1/2	0.55	23.50
SEJ518	312D	Different	1 9/16	1 1/8	Laminated Steel	9/32	1-1/6	5/8	0.55	22.60
SEJ519*	312TRI	Alike	1 9/16	1 1/8	Laminated Steel	9/32	1-1/6	5/8	0.55	51.10

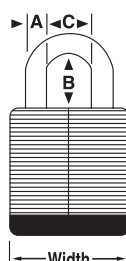

\* Set of 3 locks \*\* Thermoplastic covered shackle



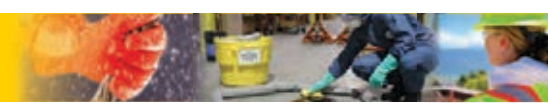

## SHROUDED PADLOCK

- Patented "Octagonal" hardened "Boron-Carbide" shackle offers 50% greater strength than hardened steel while withstanding pulling and prying attacks
- The "Octagonal" shackle makes bolt cutter attacks virtually impossible
- Key retaining safeguard insures padlock is not left unlocked
- Covered keyway for maximum weather protection and rubber body bumper for scratch resistance
- Locks come with two keys



Model No.	Mfg. No.	Body Size		Body Material	Shackle Clearance			Shipping Weight (lbs.)	Price /Each
		Width"	Thickness"		A"	B"	C"		
SEJ511	M40BLCDHC	2 3/4 Round	1 3/8	Stainless Steel	3/8	5/8	1-1/32	0.85	33.30

## LAMINATED PADLOCKS

These locks are excellent in perimeter security, storefront gates, tool cribs, construction equipment, vending machines, truck doors and general security. Full range of sizes to best secure your applications.

### COMMERCIAL LAMINATED STEEL PADLOCKS (NON-REKEYABLE)

- Constructed of hardened, rustproofed steel laminated bodies that resist cutting, sawing and corrosion
- Hardened boron steel alloy shackles offer superior cut resistances while double locking mechanism provides extra pry and pulling resistance
- 4-pin cylinders helps prevent picking while providing 1,200 key changes
- Top and bottom bumpers provide greater scratch resistance
- Locks come with two keys
- For keyed alike options and master keying, please call us

### KEYED DIFFERENT vs. KEYED ALIKE

Each keyed different lock has a unique key for higher security. Keyed alike locks have the same key for each lock. Keyed alike locks add an extra convenience where many locks are involved. Extra locks can be ordered later to fit the same key number.



Model No.	Mfg. No.	Key Type	Body Size		Body Material	Shackle Clearance			Shipping Weight (lbs.)	Price /Each
			Width"	Thickness"		A"	B"	C"		
SR890	5D	Different	2	1	Laminated Steel	3/8	1 15/16		0.80	27.70
SR867	5KA	Alike	2	1	Laminated Steel	3/8	1 15/16		0.80	29.40
SAL432	5LJ	Different	2	1	Laminated Steel	3/8	2 1/215/16		0.80	31.70
SA898	1	Different	1 3/4	7/8	Laminated Steel	5/1615/163/4			0.60	22.10
SA899	1KA	Alike	1 3/4	7/8	Laminated Steel	5/1615/163/4			0.60	23.40
SA900	1LJ	Different	1 3/4	7/8	Laminated Steel	5/162 1/23/4			0.65	25.50
SA901	1KALJ	Alike	1 3/4	7/8	Laminated Steel	5/162 1/23/4			0.65	26.40
SA894	3	Different	1 9/16	3/4	Laminated Steel	9/32 3/4 5/8			0.50	19.70
SA895	3KA	Alike	1 9/16	3/4	Laminated Steel	9/32 3/4 5/8			0.50	21.00
SA896	3LH	Different	1 9/16	3/4	Laminated Steel	9/32 2 5/8			0.58	24.30
SA897	3KALH	Alike	1 9/16	3/4	Laminated Steel	9/32 2 5/8			0.58	25.50
SA890	7	Different	1 1/8	1/2	Laminated Steel	3/16 9/161/2			0.20	15.70
SA891	7KA	Alike	1 1/8	1/2	Laminated Steel	3/16 9/161/2			0.20	16.90
SA892	7LJ	Different	1 1/8	1/2	Laminated Steel	3/162 1/21/2			0.25	19.00
SA893	7KALJ	Alike	1 1/8	1/2	Laminated Steel	3/162 1/21/2			0.25	19.90

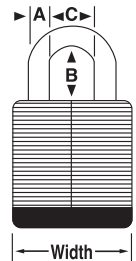

### ECONOMY LAMINATED STEEL WARDER PADLOCKS (NON-REKEYABLE)

- Warded locking mechanism minimizes jamming from dirt and grime
- Steel laminated body for superior strength, rustproofed for extended wear
- Steel alloy shackle provides strong cut resistance
- Model SEJ520 features a removable adjustable shackle from shackle heights 2 3/4" to 5 3/8"
- Model SEJ521 shackle can be shattered by a hammer in case of emergencies, ideal for emergency accesses sprinkler shut-off valves and fire hose cabinets
- Locks come with two keys

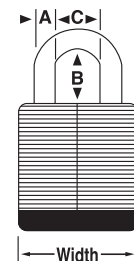

Model No.	Mfg. No.	Key Type	Body Size		Body Material	Shackle Clearance			Shipping Weight (lbs.)	Price /Each
			Width"	Thickness"		A"	B"	C"		
SEJ520	517D	Different	1 3/4	7/8	Laminated Steel	9/32	2 3/4 to 5 3/8	13/16	0.75	14.70
SA888	500	Different	1 3/4	7/8	Laminated Steel	9/32	13/16	13/16	0.45	9.12
SA889	500KA	Alike	1 3/4	7/8	Laminated Steel	9/32	13/16	13/16	0.45	10.90
SEJ521	500KABRK	Alike	1 3/4	7/8	Laminated Steel	9/32	13/16	13/16	0.45	13.40

## COMBINATION PADLOCKS

- These combination padlocks feature the new Blockguard™ anti-shim technology
- Double-reinforced stainless steel case with cold-rolled steel construction shields locking mechanism from physical attack
- Hardened steel shackles resists cutting and prying
- 40 number, 3-number dialing provides thousands of possible combinations available
- Dial automatically locks under shackle tension to prevent "feeling out" the combination and automatically scrambles when closed to prevent accidental opening
- Fits lockers with a padlock eye of at least 5/16" (8 mm) in diameter



**Master Lock**

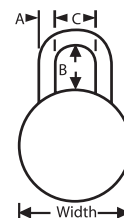

### MASTER LOCK SUPERVISORY COMBINATION PADLOCKS

- The model **SAX608** combination padlock allows a control key to be used by a supervisor to access all combination padlocks in their system - great for storage lockers
- **SAX609** control key sold separately, please call your branch for charting these locker systems

Model No.	Mfg. No.	Body Size		Body Material	Shackle Clearance			Shipping Weight (lbs.)	Price /Each
		Width"	Thickness"		A"	B"	C"		
SAX608	1525	1 7/8 Dia.	3/4	Stainless Steel	9/32	3/4	13/16	0.55	18.80
SAX609	K1525	Control Key		Brass	-	-	-	0.02	8.09

### MASTER LOCK COMBINATION PADLOCKS

- World's best selling combination lock
- Hardened steel shackle for extra cut resistance
- Combination security for keyless convenience
- Double-armored stainless steel body
- 3-digit dialing and 1500 combinations for maximum security
- Model **SR914** are school standard's in combination padlocks



**Master Lock**

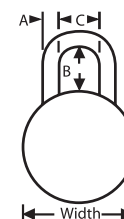

Model No.	Mfg. No.	Body Size		Body Material	Shackle Clearance			Shipping Weight (lbs.)	Price /Each
		Width"	Thickness"		A"	B"	C"		
SR914	1500	1 7/8 Dia.	3/4	Stainless Steel	9/32	3/4	13/16	0.50	13.10
SAL506	1500LH	1 7/8 Dia.	3/4	Stainless Steel	9/32	2	13/16	0.50	17.90

## MASTER LOCK HIGH SECURITY HASPS

- Ideal for vans, trucks, gates and vending machines
- Hardened steel hasp withstands forcible attacks
- Defeats attempts to pry and cut
- Designed to be used with **SGC384** (hidden shackle lock) for maximum security

SAO687

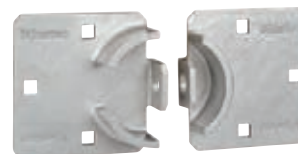

Model No.	Mfg. No.	Description	Hasp Length		Max Shackle Dia.		Shipping Weight (lbs.)	Price /Each
			Inches	mm	Inches	mm		
SAO687	770	9" x 4 1/2"	9	228	Accepts only puck locks		3.00	53.40
SGC384	A2010	Lock	-	-	-	-	-	84.70

**Master Lock**

## HINGED SECURITY HASPS

- Secure hard-to-lock property, ideal for corners and angles
- Hardened steel body for added strength
- Hardened boron alloy staples resist cutting and sawing
- Single and double hinge styles with hidden hinge pins



SHG530



SEJ524

Model No.	Mfg. No.	Description	Hasp Length		Max Shackle Dia.		Shipping Weight (lbs.)	Price /Each
			Inches	mm	Inches	mm		
SHG530	722DPFHC	Double Hinge	7 3/4	197	7/16	11	0.94	21.50
SEJ524	720DPF	Single Hinge	6 1/4	159	7/16	11	0.80	19.40

**Master Lock**

## GENERAL SECURITY HASPS

- Hardened wrought ribbed steel and rolled edge design for added strength
- Hardened steel staples resist cutting and sawing
- Hardened steel locking eyes for strong cut resistance
- Tamper proof hinges help resist prying



Model No.	Mfg. No.	Description	Hasp Length		Max Shackle Dia.		Shipping Weight (lbs.)	Price /Each
			Inches	mm	Inches	mm		
SEJ525	706D	Hard Wrought Steel Body	6	152	9/16	14	0.60	19.50
SEJ526	704DPF	Hard Wrought Steel Body	4 1/2	114	1/2	13	0.40	10.30
SAG267	703D	Hard Wrought Steel Body	3 1/2	89	11/32	9	0.30	8.13

**Master Lock**

# LOCKS

## BLUETOOTH PADLOCKS

- Includes Master Lock Vault Enterprise IOS and Android app, and web interface designed for business applications working with many locks and many users
- No keys to lose, no combinations to forget, no unauthorized key duplication
- Backup access using directional code on lock keypad
- Share access with others, temporarily or permanently, and easily monitor access with robust data and audit trails
- Low battery notification and reminder on padlock and in app
- Battery jump allows for temporary access if battery dies while locked
- Wide metal body built for durability

**Master Lock**

SGY423



Model No.	Mfg. No.	Colour	Type	Body Width"			Shackle Clearance			Key Type	Battery (included)	Price /Each	
				Width"	Height"	Dia."	Width"	Height"	Dia."				
SGY423	4400EC	Black, Silver	Indoor	1-29/32			Boron Steel	13/16	7/8	9/32	No Key	CR2450	252.00
SGY424	4401LHEC	Black	Outdoor	2-7/32			Boron Steel	15/16	2	11/32	No Key	CR2	300.00

## PROSERIES® BLUETOOTH PADLOCKS FOR BUSINESS APPLICATIONS

- Includes Master Lock Vault Enterprise IOS and Android app, and web interface, designed for business applications working with many locks and many users
- Use your smartphone to open and manage your lock with the Master Lock Vault Enterprise app
- Backup access using numeric code on lock keypad
- No keys to lose, no combinations to forget. No unauthorized key duplication
- Share access with others - temporary or permanent
- Easily monitor access with robust data and audit trails
- Low battery notification and reminder on padlock and in app
- Comes with easy to replace CR123A battery
- Body Width: 2-7/16"
- Colour: Black

**Master Lock**



SHA621

Model No.	Mfg. No.	Type	Shackle Material	Shackle Clearance			Key Type	Price /Each
				Width"	Height"	Dia."		
SHA621	6400ENT	Padlock	Boron Steel	1	1-3/8	11/32	No Key	473.00
SHA622	6400LJENT	Extended Shackle	Boron Steel	1	2-3/8	11/32	No Key	476.00
SHA623	6400SHENT	Shrouded Shackle	Boron Steel	7/8	3/4	11/32	No Key	557.00

## BLUETOOTH LOCK BOXES

- Includes Master Lock Vault Enterprise IOS and Android app, and web interface designed for business applications working with many locks and many users
- No keys to lose, no combinations to forget, no unauthorized key duplication
- Backup access using numeric code on lock keypad
- Share access with others, temporarily or permanently, and easily monitor access with robust data and audit trails
- Low battery notification and reminder on device and in app
- Removable shackle for easy portability and installation
- Large storage capacity for keys and access cards
- Wide metal body built for durability
- Body Width: 3-1/4"
- Colour: Black, Silver
- Type: Bluetooth
- Battery (included): CR123A

**Master Lock**

SGY495



Model No.	Mfg. No.	Type	Shackle Material	Shackle Clearance			Key Type	Price /Each
				Width"	Height"	Dia."		
SGY495	5440EC	Portable	Plastic	1-13/16	1-13/32	13/32	No Key	421.00
SGY496	5441EC	Wall-Mount	-	-	-	-	No Key	410.00

## ZENEX™ DIELECTRIC SAFETY PADLOCKS

- Designed exclusively for confined space, medical, military and electrical lockout/tagout
- Nylon shackle does not conduct electricity and is non-sparking
- All components are non-sparking and non-magnetic plastic, copper and brass
- Shackle withstands over 300-lb. pull force

SAR838



**Master Lock**

### 40G SERIES

Model No.	Mfg. No.	Colour	Body Size		Body Material	Shackle Clearance			Shipping Weight (lbs.)	Price /Each
			Width"	Height"		Width"	Height"	Dia."		
SAR833	406RED	Red	1 1/2	1 3/4	Thermal Plastic	25/32	1 1/2	1/4	0.21	27.50
SAR834	406ORJ	Orange	1 1/2	1 3/4	Thermal Plastic	25/32	1 1/2	1/4	0.21	27.90
SAR835	406YLW	Yellow	1 1/2	1 3/4	Thermal Plastic	25/32	1 1/2	1/4	0.21	27.90
SAR836	406GRN	Green	1 1/2	1 3/4	Thermal Plastic	25/32	1 1/2	1/4	0.21	27.90
SAR837	406BLU	Blue	1 1/2	1 3/4	Thermal Plastic	25/32	1 1/2	1/4	0.21	27.50
SAR838	406BLK	Black	1 1/2	1 3/4	Thermal Plastic	25/32	1 1/2	1/4	0.21	27.90
SAR839	406PRP	Purple	1 1/2	1 3/4	Thermal Plastic	25/32	1 1/2	1/4	0.21	27.90
SAR840	406TEAL	Teal	1 1/2	1 3/4	Thermal Plastic	25/32	1 1/2	1/4	0.21	28.80

## S31 GLOBAL ZENEX™ THERMOPLASTIC SAFETY PADLOCKS

- Designed to fit smaller diameter lockout points for lockout/tagout applications (ie European OEM Equipment)
- 3/16" (4.76 mm) diameter shackle
- Marine grade 316 stainless steel shackle for superior corrosion resistance
- Special thermoplastic body offers superior performance against chemicals, moisture, heat, cold and UV
- Operates from -70°F to +350°F (-56°C to +176°C)
- Key retaining, cannot remove key unless the shackle is closed
- Shackle withstands over 300-lb. pull force



SED617

**Master Lock**

### S31 SERIES

Model No.	Mfg. No.	Colour	Body Size		Body Material	Shackle Clearance			Shipping Weight (lbs.)	Price /Each
			Width"	Height"		Width"	Height"	Dia."		
SED617	S31BLK	Black	1 3/8	1 7/8"	Thermal Plastic	5/8	1 1/2	3/16	0.23	28.80
SED618	S31BLU	Blue	1 3/8	1 7/8"	Thermal Plastic	5/8	1 1/2	3/16	0.23	28.80
SED619	S31GRN	Green	1 3/8	1 7/8"	Thermal Plastic	5/8	1 1/2	3/16	0.23	28.80
SED620	S31ORJ	Orange	1 3/8	1 7/8"	Thermal Plastic	5/8	1 1/2	3/16	0.23	29.60
SED621	S31RED	Red	1 3/8	1 7/8"	Thermal Plastic	5/8	1 1/2	3/16	0.23	28.30
SEJ529	S31YLW	Yellow	1 3/8	1 7/8"	Thermal Plastic	5/8	1 1/2	3/16	0.23	29.60



## ZENEX™ THERMOPLASTIC SAFETY PADLOCKS

- Designed exclusively for lockout/tagout
- Durable, lightweight, non-conductive body is easy to carry
- Special thermoplastic body offers superior performance against chemicals, moisture, temperature and UV
- Reserved-for-safety cylinder provides over 40,000 unique key changes available
- Key retaining - ensures that padlocks are not left unlocked, cannot remove key until shackle is closed
- Includes write-on "Danger" and "Property of" labels in English, French and Spanish
- Locks comes with one key: Compliance with OSHA "one employee, one lock, one key" directive
- Optional shackle heights of 1-1/2" or 3" are available upon request
- For extra keys or master keying, please call us
- Body size:
  - 410 Series:** 1-1/2" W x 1-3/4" H
  - 411 Series:** 1-1/2" W x 3" H
- Body material: Thermal plastic
- Shackle clearance: 25/32" W x 1-1/2" H x 1/4" Dia.



### 410 SERIES - KEYED DIFFERENT

Model No.	Mfg. No.	Colour	Price /Each
SAL134	410BLK	Black	26.40
SAL135	410BLU	Blue	26.40
SAL136	410GRN	Green	26.40
SAL137	410ORJ	Orange	26.40
SAL138	410RED	Red	26.40
SAL139	410YLW	Yellow	26.40

### 411 SERIES - KEYED DIFFERENT

Model No.	Mfg. No.	Colour	Price /Each
SAL140	411BLK	Black	31.20
SAL141	411BLU	Blue	31.20
SAL142	411GRN	Green	31.20
SAL143	411ORJ	Orange	31.20
SAL144	411RED	Red	30.80
SAL145	411YLW	Yellow	31.20

### 410 SERIES - KEYED ALIKE

Model No.	Mfg. No.	Colour	Price /Each
SETS OF 3			
SDM765	410KAS3RED	Red	87.00
SDM767	410KAS3YLW	Yellow	87.00
SDM761	410KAS3BLU	Blue	87.00
SETS OF 6			
SDM773	410KAS6RED	Red	174.00
SDM775	410KAS6YLW	Yellow	174.00
SDM769	410KAS6BLU	Blue	174.00
SETS OF 12			
SDM781	410KAS12RED	Red	349.00
SDM783	410KAS12YLW	Yellow	349.00
SDM777	410KAS12BLU	Blue	349.00

Available in sets of 18 and 24. Also available in other colours.

### 411 SERIES - KEYED ALIKE

Model No.	Mfg. No.	Colour	Price /Each
SETS OF 3			
SDM805	411KAS3RED	Red	100.00
SDM807	411KAS3YLW	Yellow	100.00
SDM801	411KAS3BLU	Blue	100.00
SETS OF 6			
SDM813	411KAS6RED	Red	202.00
SDM815	411KAS6YLW	Yellow	202.00
SDM809	411KAS6BLU	Blue	202.00
SETS OF 12			
SDM821	411KAS12RED	Red	402.00
SDM823	411KAS12YLW	Yellow	402.00
SDM817	411KAS12BLU	Blue	402.00

Available in sets of 18 and 24. Also available in other colours.

## PADLOCK IDENTIFICATION LABELS

- Optimize your facility's lockout practices with photo ID labels or laminated safety padlock labels for your employee's safety padlocks
- **Photo ID labels:** Self adhesive labels to be applied to your safety padlocks
- Customer can print their own photo and size it to fit photo ID label
- **Laminated identification labels:** Self adhesive labels with clear overlaminates to be applied to your safety padlocks



Model No.	Mfg. No.	Description	Dimensions			Price /Each
			W"	x	T"	
SEJ530	S142	Photo ID Labels for 410, S31, S33 Padlocks (6 labels/pkg.)	1	x	1	10.50
SEJ531	0411-5705	Photo ID Labels for 411 Series Padlocks (6 labels/pkg.)	1	x	3-5/8	11.70
SEJ533	461	Padlock Safety Labels w/clear overlaminates (50 labels/pkg.)	5	x	1	93.60

## LASER ENGRAVING

- A permanent and durable method to customize your safety padlocks
- Available on Master Lock/American Lock aluminum and Zenex™ padlocks
- Laser engrave information on the padlock face, side and back
- A name, company logo or key number, you select the important information to engrave on the padlock
- For further laser engraving customization of your padlocks, please call us!

# LOCKS

## AMERICAN LOCK® ANODIZED ALUMINUM SAFETY PADLOCKS

- Over 10 000 unique key changes available
- Your facility's padlocks can be key charted to ensure no key duplication on site....ask about this service
- Durable, anodized colour finish is suitable for lockout/tagout procedures in food processing and pharmaceutical facilities
- Uses FDA approved lubricants safe for use in food processing
- Lightweight solid aluminum body for lockout/tagout
- Safety colour recognition, plus high security
- Key retaining option available. Includes two keys per lock
- Keyed different
- Optional shackle heights of 1", 1 1/2" or 3" are available upon request
- Removable 5-pin cylinder can be replaced or repined
- For keyed alike options or master keying, please call us
- Body size: 1-1/2" W x 1-3/4" H
- Body material: Aluminum
- Shackle clearance: 3/4" W x 1" H x 1/4" Dia.



### A1105 SERIES - KEYED ALIKE\*

Model No.	Mfg. No.	Colour	Price /Each
<b>SETS OF 3</b>			
SDM877	A1105KAS3RED	Red	93.90
SDM878	A1105KAS3YLW	Yellow	93.90
SDM871	A1105KAS3BLU	Blue	93.90
<b>SETS OF 6</b>			
SDM886	A1105KAS6RED	Red	188.00
SDM887	A1105KAS6YLW	Yellow	188.00
SDM880	A1105KAS6BLU	Blue	188.00
<b>SETS OF 12</b>			
SDM895	A1105KAS12RED	Red	376.00
SDM896	A1105KAS12YLW	Yellow	376.00
SDM889	A1105KAS12BLU	Blue	376.00

Also available in other colours  
\*Each keyed alike set includes 2 keys only per set

### A1105 SERIES - KEYED DIFFERENT

Model No.	Mfg. No.	Colour	Price /Each
SA0712	A1105BLK	Black	28.60
SA0713	A1105BLU	Blue	28.60
SA0714	A1105GRN	Green	28.60
SA0715	A1105ORJ	Orange	28.60
SA0716	A1105RED	Red	28.60
SA0717	A1105YLW	Yellow	28.60
SA0718	A1105BRN	Brown	29.10
SA0719	A1105CLR	Clear	28.60
SA0720	A1105PRP	Purple	28.60

## LAMINATED STEEL SAFETY LOCKOUT PADLOCKS

- Reinforced laminated steel body construction withstands physical abuse
- Uses FDA approved lubricants safe for use in food processing
- 9/32" diameter boron steel shackle with plated finish for corrosion resistance
- Over 1,400 unique key changes available
- Comes with one key per padlock
- Optional shackle heights of 3/4", 1 1/2" or 2" are available upon request
- Your facility's padlocks can be key charted to ensure no key duplication on site....ask about this service
- For keyed alike options or master keying, please call us



### 3 SERIES

Model No.	Mfg. No.	Colour	Body Size		Body Material	Shackle Clearance			Shipping Weight (lbs.)	Price /Each
			Width"	Thickness"		A"	B"	C"		
SAL146	3BLU	Blue	1-9/16	1-1/2	Laminated Steel	9/32	3/4	5/8	0.40	21.10
SAL147	3RED	Red	1-9/16	1-1/2	Laminated Steel	9/32	3/4	5/8	0.40	21.10
SAL148	3YLW	Yellow	1-9/16	1-1/2	Laminated Steel	9/32	3/4	5/8	0.40	21.70
SAL149	3GRN	Green	1-9/16	1-1/2	Laminated Steel	9/32	3/4	5/8	0.40	21.70
SAL150	3BLK	Black	1-9/16	1-1/2	Laminated Steel	9/32	3/4	5/8	0.40	21.10
SAL151	3WHT	White	1-9/16	1-1/2	Laminated Steel	9/32	3/4	5/8	0.40	21.70
SAL152	3LHBLU	Blue	1-9/16	1-1/2	Laminated Steel	9/32	2	5/8	0.42	25.70
SAL153	3LHRED	Red	1-9/16	1-1/2	Laminated Steel	9/32	2	5/8	0.42	25.30
SAL154	3LHYLW	Yellow	1-9/16	1-1/2	Laminated Steel	9/32	2	5/8	0.42	26.50
SAL155	3LHGRN	Green	1-9/16	1-1/2	Laminated Steel	9/32	2	5/8	0.42	26.50
SAL156	3LHBLK	Black	1-9/16	1-1/2	Laminated Steel	9/32	2	5/8	0.42	25.70
SAL157	3LHWHT	White	1-9/16	1-1/2	Laminated Steel	9/32	2	5/8	0.42	25.30

## PORTABLE GROUP LOCK BOXES

- 430-grade stainless steel construction maximizes corrosion resistance
- Clear, impact-resistant window provides visibility to secured keys
- 18 numbered lockout holes for easy identification
- Latch with lock hole on front for operations lock
- Flanged design on sides offers easy application of locks
- Gasketed key slot to drop keys into removable cup
- Drain holes on bottom to limit liquids from accumulating inside
- Stackable design facilitates storage and simplifies transporting multiple boxes
- Replacement removable key cups available (PKG P43216)



SGC388



SGC389

Model No.	Max No. of Padlocks	Description	Internal Storage Dimensions			Price /Each
			L"	x W"	x H"	
SGC387	30	Small Group Lock Box	9 11/16	x 4 7/8	x 5 13/32	193.00
SGC388*	30	Small Group Lock Box	9 11/16	x 4 7/8	x 5 13/32	188.00
SGC389	55	Large Group Lock Box	9 11/16	x 4 7/8	x 7 49/64	246.00

\*Side window to view unused locks

## LATCH TIGHT™ LOCK BOXES

- Integrated storage organizes up to 12 keys or hundreds of bulk keys
- Can only release when no padlocks are fastened to the lock box
- Works with all safety padlock shackle sizes and lengths
- Traditional bulk key storage is also possible through the key slot in front of the lock box lid
- Has lockout points for 14 padlocks or hasps
- Unit can be mounted to a wall or carried with the comfortable form fitted handle
- Powder coated finish on heavy-duty steel box and stainless steel handle withstand harsh industrial environments



**Master Lock**

Model No.	Mfg. No.	Colour	Price /Each
SA0597	503RED	Red	152.00
SA0628	503YEL	Yellow	159.00

## LATCH TIGHT™ PORTABLE LOCK BOXES

- With new Latch Tight™ locking mechanism
- English, Spanish, French message on box
- Accepts 12 padlocks or lockout hasps
- Complements SA0597 and SA0628 wall mount lock box (call for more info)
- Colour: Red

Model No. SA1519  
Mfg. No. 498A  
Price/Each \$149.00



**Master Lock**

## PADLOCK CADDIES

- Durable plastic construction
- Allows user to carry or store safety locks to address all lockout points
- Can be customized to the number of padlocks needed by user for lockout points (max 12 locks)
- Can be carried, mounted on belt or hung at lockout site
- Collated key holder ensures user's key is with the locks
- Dimensions: 7 1/4" W x 5 1/8" H x 19/32" Thick
- Ergonomic carry handle

Model No. SAR846  
Mfg. No. S125  
Price/Each \$22.50



Note: Padlocks and key not included

**Master Lock**

## HEAVY-DUTY PADLOCK RACK STATIONS

- Locate padlocks near lockout point
- Heavy gauge steel with durable powder coat finish ensures long life in manufacturing environment
- Includes labels in English, French and Spanish



SAP986



SAP985

**Master Lock**

Model No.	Mfg. No.	Description	Padlock Capacity	Price /Each
SAP985	S1506	6 1/4" x 1 1/2"	6 to 8	37.40
SAP986	S1518	17 1/2" x 1 1/2"	18 to 22	57.20

## ULTRA COMPACT LOCK BOX

- Ideal for group lockout situations with multiple isolation points and employees performing maintenance activities on industrial equipment
- Compact size so it easily fits into a toolbox, bag, or the palm of your hand
- Wall mountable and detachable for ultimate portability
- Hinged transparent cover for easy viewing of contents inside
- Capacity for up to 12 workers to attach their products
- Exclusive key slot design with retainer fits a variety of key thicknesses while maintaining lockout security
- Fits SafeKey lockout padlock keys
- 12 Lock capacity with 6 stored inside and 6 clipped outside
- Material: Plastic
- Coating Material: Nylon
- Service Temp. Range: -4 °F - 262 °F



**BRADY**

Model No.	Mfg. No.	Colour	Dimensions Height" x Width" x Depth"	Weight lbs.	Price /Each
SGZ621	149173	Red	5.7 x 4 x 2.7	0.6	71.99

## COMPACT LOCKOUT STATIONS

- Ideal for locating machine specific lockout devices, tags and padlocks near lockout point
- 6 1/2" W x 2 7/8" D x 2 7/8" H bin holds circuit breaker lockouts, valve lockouts, plug lockouts, tags and much more
- Hanger clips hold padlocks and hasps
- Dimensions: 9 3/4" x 7 3/4" x 3 3/8"
- Includes face labels in English, French and Spanish



SAP992

**Master Lock**

Model No.	Mfg. No.	Description	Contains	Price /Each
SAP990	S1700	Compact Lockout Station	Unfilled	53.60
SAP992	S1720E410	Circuit Breaker Lockout Station	Two SA0595 and two SA0594 breaker lockouts, four tags and two Zenex™ locks	171.00

## DELUXE LOCKOUT STATIONS

- Durable construction ensures long life in manufacturing facilities
- Covered compartments protects devices and keep dust and grime out
- 16 hanger clips holds two padlocks or hasps each
- Moveable dividers in top and bottom trays help organize devices
- Holes provided along the bottom for optional peg hook hangers to hang bulky devices
- Lower half has two tip-out drawers, each measuring 10" W x 6 7/8" H x 1/4" D
- Dividers included to create 2, 3, 4, 5 or 6 compartments
- Each compartment in lower section holds 25 tags, 150 tags total
- Lockout stations are bilingual with English/French labels and lockout tags
- Dimension: 23.5" W x 4.5" D x 27" H
- Station includes: 6 padlocks, 2 hasps, 1 snap-on hasp, 1 adjustable cable lockout, 4 gate valve lockout, 2 ball valve lockout, 1 compact plug prong lockout, 1 plug cover, 6 circuit breaker lockout, 2 wall switch covers, 2 packs of tags (12/pack)



SAS412

**Master Lock**

Model No.	Mfg. No.	Description	Price /Each
SAS412	S1900VE410FRC	Station with Zenex™ Padlocks	1361.00



# LOCKS

## LOCKOUT STATIONS

### Virtually Indestructible, the Strongest Stations Available!

- Integrated, one-piece molded construction eliminates loose parts
- Resilient polycarbonate material provides twice the heat resistance and quadruples the impact strength of typical stations
- Reinforced snap-lock clips provide easy padlock and hasp storage and removal
- Exclusive translucent lockable cover protects contents and prevents loss of valuable safety lockout padlocks
- Innovative hinge holds cover open for easy product selection
- Available with your choice of safety lock design with highly visible red locks keyed different of Zenex™ or aluminum in 4, 10 or 20 lock format
- Zenex™ locks available with up to 100,000 key changes available to fit even the largest lockout systems
- Compliant with OSHA "One employee, One lock, One key" directive
- Lockout stations are bilingual with English/ French labels and lockout tags

### 4-LOCK STATIONS INCLUDE:

- 4 Master Lock® Safety Series™ padlocks
- 2 Safety Series™ hasps for lockouts by up to six workers
- 12 Safety Series™ heavy-duty bilingual "Do Not Operate" lockout I.D. tags with brass grommets
- Dimensions: 12.25" x 16" x 1.75"

Model No	Mfg. No.	Description	Price /Each
SGW123	1482B	Trilingual Covered Lock Station (Base only, unfilled)	167.00
SA0602	1482BP410FRC	Station with Zenex™ Padlocks	337.00
SA0603	1482BP1106FRC	Station with American Lock® Aluminum Padlocks	327.00

### 10-LOCK STATIONS INCLUDE:

- 10 Master Lock® Safety Series™ padlocks
- 2 Safety Series™ hasps for lockouts by up to six workers
- 24 Safety Series™ heavy-duty bilingual "Do Not Operate" lockout I.D. tags with brass grommets
- Dimensions: 15.5" x 22" x 1.75"

Model No	Mfg. No.	Description	Price /Each
SGW124	1483B	Trilingual Covered Lock Station (Base only, unfilled)	241.00
SA0605	1483BP410FRC	Station with Zenex™ Padlocks	635.00
SA0606	1483BP1106FRC	Station with American Lock® Aluminum Padlocks	621.00

### 20-LOCK STATIONS INCLUDE:

- 20 Master Lock® Safety Series™ padlocks
- 4 Safety Series™ hasps for lockouts by up to six workers
- 48 Safety Series™ heavy-duty bilingual "Do Not Operate" lockout I.D. tags with brass grommets
- Dimensions: 22" x 22" x 1.75"

Model No	Mfg. No.	Description	Price /Each
SGW125	1484B	Trilingual Covered Lock Station (Base only, unfilled)	322.00
SA0608	1484BP410FRC	Station with Zenex™ Padlocks	1211.00
SA0609	1484BP1106FRC	Station with American Lock® Aluminum Padlocks	1181.00

## DELUXE TAG STATION

- Two tip-out bins each have three compartments for tags
- Each compartment holds 25 tags, capacity 150 tags
- Compartments can also hold safety eyewear and ear protection
- Each tip-out drawer measures 10" W x 6 3/4" H x 3 1/2" D
- Eight hanger clips can hold safety padlocks or hasps
- Dimension: 22" W x 4" D x 11" H

Model No. SAS423  
Mfg. No. S1800  
Price/Each \$168.00



SA0602



SA0605



SA0609



TAGS NOT INCLUDED

SAS423



## STANDARD LOCKOUT KIT WITH ZENEX™ THERMOPLASTIC LOCKS

- With plastic padlocks, hasps, tags, and assortment of devices, this kit provides the standard equipment needed for electrical lockout and it all fits neatly inside the zippered pouch
- Pouch also features a compact, convenient design with velcro straps on back to allow it to be easily applied to or removed from a belt
- Straps serve as breakaway feature in the event the pouch becomes caught in machinery, protecting the employee
- Includes: (1) S1010 Compact zippered pouch, (2) 410KARED Zenex™ thermoplastic padlocks, (2) 493B 120/240V Circuit breaker lockout devices, (1) 491B 480V Circuit breaker lockout device, (1) S3823 480/600V Oversized handle circuit breaker lockout device, (2) 420 1" Steel jaw hasps, (1) S2005 Plug prong lockout, (3) 497A "Do Not Operate" laminated lockout tag pack (12 tags per pack)



Model No.	Mfg. No.	No. of Components Included	Type of Kit	Usage Rating	Lock Body Width"	Lock Shackle Dimensions				Lock Key Type	Price /Each	
						L"	x	W"	x	Dia."		
SGZ651	S1010E410KAFRC	13	Electrical	Severe Use	1-1/2	1-1/2	x	25/32	x	1/4	Keyed Alike	176.00

## BASIC LOCKOUT KIT WITH ZENEX™ THERMOPLASTIC LOCKS

- With plastic padlocks, hasps, tags, and assortment of devices, this kit has the basic essentials to conduct electrical lockout
- All lockout equipment comes in a rugged toolbox to help keep important lockout devices and padlocks together
- For added individual worker convenience, padlocks are supplied keyed alike
- Includes: (1) S1017 Durable lockout toolbox, (3) 410KARED Zenex™ thermoplastic padlocks, (1) 493B 120/240V Circuit breaker lockout device, (1) 491B 480V Circuit breaker lockout device, (1) S3823 480/600V Oversized handle circuit breaker lockout device, (1) S3822 480/600V Molded case circuit breaker lockout device, (1) S3821 120/240V Miniature circuit breaker lockout device, (2) 1" 420 Steel jaw hasps, (1) 428 Plastic hasp, (1) S2005 Plug prong lockout, (1) 496B Wall switch cover, (6) 497A "Do Not Operate" laminated lockout tag pack (12 tags per pack)



Model No.	Mfg. No.	No. of Components Included	Type of Kit	Usage Rating	Lock Body Width"	Lock Shackle Dimensions				Lock Key Type	Price /Each	
						L"	x	W"	x	Dia."		
SGZ636	1457E410KABAS	20	Electrical	Severe Use	1-1/2	1-1/2	x	25/32	x	1/4	Keyed Alike	306.00

## PREMIER LOCKOUT KIT WITH ZENEX™ THERMOPLASTIC LOCKS

- With plastic padlocks, hasps, tags, and a premier assortment of electrical and valve devices, this portable kit has everything needed for lockout stored in a convenient carrying case
- The soft sided carrying case comes with two clear storage compartments that help organize lockout devices and padlocks for easy accessibility
- Includes: (1) 1458 Carrying case with organizer, (6) 410RED Zenex™ thermoplastic padlocks, (1) 468L Handle-off device, (1) S3068 Ball valve lockout device, (1) S806 Cable lockout device, (3) 493B Circuit breaker lockout device for 120/240V, (2) 491B Circuit breaker lockout devices for 480V, (1) S3823 Circuit breaker lockout device for 480/600V, (2) S3822 Circuit breaker lockout devices for 480/600V, (3) S3821 Circuit breaker lockout devices for 120/240V, (1) 480 Gate valve lockout for 1" to 3" diameter handle, (1) 481 Gate valve lockout for 2" to 5" diameter handle, (1) 482 Gate valve lockout for 4" to 6.5" diameter handle, (3) 420 1" Steel jaw lockout hasps, (3) 428 Plastic lockout hasps, (1) 487 Small rotating plug lockout, (1) 488 Large rotating plug lockout, (1) 496B Wall switch cover, (1) 497A "Do Not Operate" laminated lockout tag pack (12 tags per pack)



Model No.	Mfg. No.	No. of Components Included	Type of Kit	Usage Rating	Lock Body Width"	Lock Shackle Dimensions				Lock Key Type	Price /Each	
						L"	x	W"	x	Dia."		
SGZ644	1458VE410PRE	34	Electrical, Valve	Severe Use	1-1/2	1-1/2	x	25/32	x	1/4	Keyed Different	901.00

# LOCKS

## ADJUSTABLE CABLE LOCKOUTS

- Infinitely adjustable for a secure fit every time
- Integrated, single-piece safety hasp and cable for ease-of-use
- Ideal for both multiple circuit breaker panel and side-by-side gate valve lockouts
- Tough, lightweight, Zenex™ thermoplastic body withstands chemicals; performs effectively in extreme conditions
- Tough flexible multistranded steel cable is insulated with a clear plastic coating
- Up to four workers can apply their personal safety locks
- Red lockout colour identifies the safety lockout application
- Complete with high-visibility permanent safety labels (English, French and Spanish) that can be written on to identify the responsible person and then erased for the next job
- Custom cable lengths available

**Master Lock**

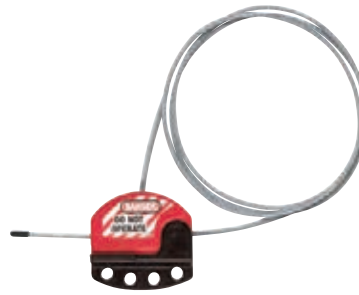

Model No.	Mfg. No.	Description	Price /Each
SED596	S806CBL3	Cable lockout w/3' cable	53.60
SED597	S806	Cable lockout w/6' cable	53.60
SED598	S806CBL15	Cable lockout w/15' cable	64.20

## LABELED SNAP-ON HASPS

- Combines multiple-person lockout and tagout identification
- Features an easy-to-apply "snap-on" advantage with its spring-loaded locking arm
- Fits more lockout points than alternative rivet-hinge labeled lockout hasps
- Anodized aluminum and stainless steel construction for combined corrosion resistance and strength
- Complete with high-visibility permanent safety labels (English, French and Spanish) that can be written on to identify the responsible person and then erased for the next job
- Max. No. of Padlocks: 5



SAL541

**Master Lock**

Model No.	Mfg. No.	Colour	Price /Each
SAL541	427	Red	30.50

## SAFETY LOCKOUT HASP

- For use when more than one employee is part of a lockout procedure
- Attached to energy disconnect
- Galvanized steel jaw with red vinyl coating on handle
- Max. No. of Padlocks: 6
- Colour: Red
- Jaw Diameter: 0.25"



**ZENITH**  
Safety Products

Model No.	Inside Jaw Clearance"	Dimensions	Price /Each
SGY226	1	4.5" x 1.5"	6.80
SGY227	1.5	5" x 1.5"	6.99

## SAFETY LOCKOUT HASPS

- Attach hasp to energy disconnect switch
- Control cannot be turned on until last worker's padlock is removed from hasp
- Multiple styles available



SEA314



SEA315



SAO704



SA875

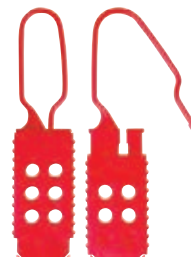

SAR075



SAO703



SED601

**Master Lock**

Model No.	Mfg. No.	Description	Dimensions			Inside Jaw Clearance"	Jaw Dia.	Padlock Capacity	Price /Each
			W"	x	L"				
SEA314	416	Spark Resistant Aluminum	1-1/2	x	4-3/8	1	1/4"	6	11.60
SEA315	417	Spark Resistant Aluminum	2	x	4-7/8	1-1/2	1/4"	6	13.50
SAO704	418	Heavy-Duty Steel	2-3/8	x	3-1/4	1	1/4"	4	13.80
SAO705	419	Heavy-Duty Steel	2-3/8	x	6-7/8	3	1/4"	8	16.40
SA875	420	Steel Jaw w/Vinyl Coated Handle	1-3/4	x	4-1/2	1	1/4"	6	11.10
SA876	421	Steel Jaw w/Vinyl Coated Handle	2-3/8	x	5	1-1/2	1/4"	6	12.70
SAR075	428	Nylon Non-Conductive Hasp	1-5/8	x	6-7/8	1 x 2-1/2	3/16"	6	11.10
SAO703	429	Dual Jaw Aluminum Hasp	2	x	5-7/8	1 x 2-1/2	1/4"	8	16.50
SED601	5430	Steel Hasp w/Red Plastic Handle	2-1/4	x	3"	1	4 mm	2	11.30



## GRIP TIGHT™ CIRCUIT BREAKER LOCKOUTS

- Fits all American Lock® and Master Lock® safety padlocks and hasps
- Two products replace at least five. SAO595 is used for single and double breaker toggles, while SAO594 is appropriate for tall and wide breaker toggles
- Grips tight with a simple thumb turn and clamping handle
- Narrow profile permits side-by-side breaker lockout
- Made of powder coated steel and reinforced polymer to operate in harsh conditions



**Master Lock**

Model No.	Mfg. No.	Description	Price /Each
SAO594	491B	Tall & Wide Toggles	19.30
SAO595	493B	Standard Single and Double Toggles	14.50
SAO707	506	Set of each SAO594 and SAO595	33.20

## ROTATING ELECTRICAL PLUG LOCKOUTS

- Outward/inward rotation allows for easier installation and storage
- Unique outward rotation allows for easier installation in confined space applications
- Surrounds the electrical plug; protects against accidental reconnection
- Each size rotates into itself to fit effectively into safety tool boxes
- Tough, lightweight, dielectric Zenex™ thermoplastic bodies withstand chemicals; perform effectively in extreme conditions (temperature range -50°F (-46°C) to 350°F (177°C))
- Complete with high-visibility permanent safety labels (English, French and Spanish)
- The SAL521 labels can be written-on to identify the responsible person and then erased for the next job



Model No.	Mfg. No.	For Electrical Plugs Sizes Up To	Price /Each
SAL520	487	2 1/4" Dia. x 3 1/4" w/Cord Dia. up to 3/4" (Most 110- and Many 220-Volt Plugs)	27.40
SAL521	488	3" Dia. x 6" w/Cord Dia. up to 3/4" (Most 220- and 550-Volt Plugs)	36.40

## CIRCUIT BREAKER SWITCH PADLOCKS

- Provides the flexibility to effectively lock out breaker switches
- Flexi-cable allows the lock body to be moved out of the way and panel door to be closed properly
- Fits the tight space constraints within a circuit breaker shutoff boxes
- Numerous key changes are available to minimize the possibility of unwanted key duplication
- 1 1/8" wide steel body; 4-pin cylinder; 5" flexible steel cable

Model No. SAL525  
Mfg. No. 7CSRED  
Price/Each \$18.90



**Master Lock**

## ELECTRICAL LOCKOUT

- Keeps employees safe from unexpected equipment activation
- Hexagon lockout design, suitable for a variety industrial plugs
- Constructed from durable polypropylene
- Type of Electrical Device: Plug
- Material: Polypropylene
- Legend: Locked Out Do Not Remove
- Colour: Red



**ZENITH**  
Safety Products

Model No.	Dimensions	Price /Each
SGY228	2" x 2" x 5"	14.99
SGY229	3.25" x 3.25" x 7"	24.99

## UNIVERSAL WALL SWITCH COVERS

- Prevent unintentional toggling of wall switch to "ON" position
- One-time installation uses the existing wall plate screws
- Hinges open for unobstructed normal operation switch
- Lock the switch in either the "ON" or "OFF" position by closing the cover over the switch, then applying padlock
- Locks out both toggle and Decora™ paddle wall switches

Model No. SAO708  
Mfg. No. 496B  
Price/Each \$18.70



**Master Lock**

## COMPACT PLUG PRONG LOCKOUTS

- Compact design locks out 110 V – 120 V electrical plugs
- Works with two-prong or two-prong with ground plugs
- Can be used with safety padlocks or lockout hasps, no key needed
- New design can now accommodate larger shackle locks and safety hasps



See pages 540-542 for padlock assortment

**Master Lock**

Model No.	Mfg. No.	Description	Price /Each
SAR841	S2005	Electrical Outlet Lockout	21.20

# LOCKS

## SEAL TIGHT™ HANDLE-ON BALL VALVE LOCKOUTS

- Patent-pending innovative design locks out the ball valves from 1/4" to 4"
- Lightweight and compact ergonomic design allows easy use and storage
- Constructed of metal alloy, this lockout device withstands corrosive environments and operates in extreme temperatures
- Works in virtually all ball valve installations – metal and PVC valves, insulated pipes, and pipes with tight access due to close proximity to other valves, pipes or structures
- Works with all Master Lock® and American Lock® safety padlocks and safety hasps

Model No. SAS463  
Mfg. No. S3068  
Price/Each \$73.10

**Master  
Lock.**

See pages 540-542 for  
padlock assortment

Padlock  
not included



## ADJUSTABLE VALVE LOCKOUT

- Easy to use lockout device prevents accidental activation of a closed ball valve
- Adjustable design fits 1/2in (13mm) to 2in (51mm) valves
- Durable, lightweight Zenex™ thermoplastic material is chemical resistant and performs effectively in extreme environments
- Removable insert accommodates a wide range of handle designs and dimensions
- Works with S806 cable lockout device for the most secure fit
- Four locking holes to accept all Master Lock and American Lock safety padlocks
- Valve Type: Ball
- Colour: Red

Model No. SHF942  
Mfg. No. S3080  
Price/Each \$49.20

**Master  
Lock.**



## VALVE LOCKOUT

- Cover the valve handle with the gate valve lockout device and apply a personal padlock and lockout tag to ensure employee safety
- Supplied with English and French danger labels
- Extremely rugged construction for superior security
- Valve Type: Gate
- Material: Plastic, Nylon, ABS
- Colour: Red
- Risk Type: Mechanical Risk
- Legend: Danger Locked Out Do Not Remove

**ZENITH®**  
Safety Products



Model No.	Valve Wheel Diameter	Price /Each
SHA670	1"-2.5"	15.95
SHA671	2.5"-5"	19.95
SHA672	5"-6.5"	25.95
SHA673	6.5"-10"	39.95

## BUTTERFLY VALVE LOCKOUT

- Adjustable butterfly valve lockout
- Locks out valve in seconds by feeding SED597 (S806) - 6 ft cable or SED596 (S806CBL3) - 3 ft cable lockout device through desired eyelet and around valve neck
- Durable, lightweight thermoplastic material is chemical resistant and performs effectively in extreme environments
- Directional application arrows allow for ease of installation and minimize user error
- Stainless steel rivet allows device to smoothly pivot open and closed to ensure proper fit

**Master  
Lock.**

Model No.	Mfg. No.	Description	Price /Each
SEK636	S3920	Lockout Device Only	39.50
SEK637	S3921	Lockout Device & SED596 Adjustable Cable Lockout	74.70

SEK636



SEK637

## SEAL TIGHT™ BALL VALVE LOCKOUTS

- Compact, lightweight, flexible and easy to use, the Seal Tight™ valve lockout works on virtually every valve size and applications
- Eliminates the risk of accidentally moving a handle by removing it and concealing the stem
- Effectively locks out all valves from 3/8" to 4", thus eliminating specific valve lockout systems
- Simple to apply, with an intuitive wrapping strap and locking mechanism
- Works on virtually all valves; metal and PVC, insulated pipes, ceiling or wall-mounted pipes and hard to reach valves
- Made of PVC polyester fabric and HDPE plastic, it withstands corrosive environments and operates in temperatures from -40°F to 300°F

Model No. SAO596  
Mfg. No. 468L  
Price/Each \$56.80

**Master  
Lock**



## ELECTRICAL LOCKOUT OVERSIZED PLUG AND HOIST CONTROL COVER

- Offers broad application solutions sized at 7" diameter by 17" tall
- Insert PVC tubing to block access to control buttons for hoist control lockout
- Flexible and durable rip-stop nylon bag fits easily in safety tool boxes
- Lock out with up to six padlocks or hasps
- Trilingual lock out warning printed on bag

Model No. SAO706  
Mfg. No. 453L  
Price/Each \$59.40



**Master  
Lock**

## BLIND FLANGE LOCKOUT DEVICE

- Cover and lock out nuts ranging from 3/4" to 1-1/8" diameter
- Adjustable device provides a tight fit, adapting to multiple flanged pipe applications
- Device fully conceals flange bolts preventing access to the blind until all work has been completed
- Four locking holes allow for multiple workers to lockout device at one time
- Durable aluminum and hardened steel construction withstands conditions indoors and out



**Master  
Lock**

Model No.	Mfg. No.	Size	Pipe Diameter Range	Nut Diameter	Flange Width Range	Price /Each
SDS646	S3922	Small	1/2" – 3" (12.7 mm – 76.2 mm)	1-1/8" (19 mm – 28.7 mm)	1-1/2" – 5-5/8" (38.1 mm – 143.3 mm)	138.00
SDS647	S3923	Medium	3-1/2" – 12" (88.9 mm – 304.8 mm)	1" – 1-7/8" (33.3 mm – 47.8 mm)	3-3/4" – 10-3/4" (95.3 mm – 274.6 mm)	158.00
SDS648	S3924	Large	14" – 24" (355.6 mm – 609.6 mm)	2" – 2-3/4" (52.3 mm – 69.9 mm)	7-3/4" – 17-7/8" (196.9 mm – 447.8 mm)	230.00

## ROTATING GATE VALVE LOCKOUTS

- Outward/inward rotation allows for easier installation and storage
- Unique, patent-pending outward rotation allows for easier installation in confined space applications
- Surrounds the valve operating handle, protects against accidental valve opening
- Each size rotates into itself to fit effectively into safety tool boxes
- Each size nests within the next larger size to save space in storage
- Tough, lightweight, dielectric Xenex™ thermoplastic bodies withstand chemicals; perform effectively in extreme conditions (temperature range -50°F (-46°C) to 350°F (177°C))
- Up to four workers can apply their personal safety locks
- Red lockout colour identifies the safety lockout application
- Complete with high-visibility permanent safety labels (English, French and Spanish) that can be written on to identify the responsible person and then erased for the next job



SAL529



SAL528



SAL531

**Master  
Lock**

Model No.	Mfg. No.	Description	Price /Each
SAL526	480	Fits 1" to 3" Dia. Valve Handle	28.10
SAL527	481	Fits 2" to 5" Dia. Valve Handle	43.10
SAL528	482	Fits 4" to 6 1/2" Dia. Valve Handle	58.70
SAL529	483	Fits 6" to 10" Dia. Valve Handle	80.40
SAL530	484	Fits 8" to 13" Dia. Valve Handle	141.00
SAL531	485	1 Set Consists of 1 x SAL526, SAL527, SAL528, SAL529 & SAL530	337.00



# TAGS

## SAFETY TAGS

- Header style tags meet Occupational Safety and Health Administration requirements
- Choose from a variety of common styles and legends that apply to a variety of situations
- Tags are available in two materials: **PF-cardstock** and **RV-plastic**
- 25 per package

### PF-Cardstock

- 5 7/8" x 3 1/8" with 3/8" hole
- Pliable, 10-mil plastic
- Pulp-free, no wood-paper content
- Waterproof, tear-resistant for short-term use

### RV-Plastic

- 5 7/8" x 3 3/8" with 3/8" hole, reinforced with metal grommet
- 15-mil tear-resistant plastic
- Weather and chemical-resistant

## BLANK HEADER TAGS



Front Back

SAU650  
SAU651



Front Back

SAU654  
SAU655



Front Back

SAU658  
SAU659

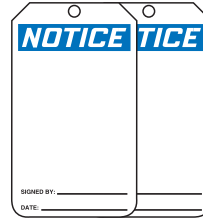

Front Back

SAU662  
SAU663

Material  
PF-Cardstock  
RV-Plastic

## STANDARD SAFETY TAGS



SAT022  
SAT045



SAU606  
SAU607



SAU610  
SAU611



SAU614  
SAU615



SAU618  
SAU619



SAU626  
SAU627

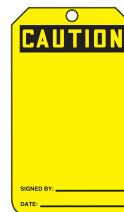

SAU634  
SAU635

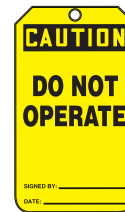

SAU638  
SAU639

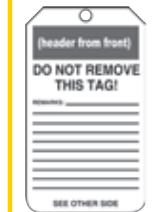

Standard Back

Material  
PF-Cardstock  
RV-Plastic

## LOCKOUT TAGS



SAU778  
SAU779



SAU782  
SAU783



SAU790  
SAU791



SAU786  
SAU787



SAU806  
SAU807



SAU802  
SAU803



SAU810  
SAU811

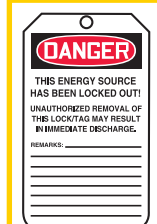

Std. Lockout Back

Material  
PF-Cardstock  
RV-Plastic

## EQUIPMENT STATUS & INSPECTION TAGS



Front Back

SAU698  
SAU699



Front Back

SAU706  
SAU707



Front Back

SAU714  
SAU715



Front Back

SAU718  
SAU719



Front Back

SAU734  
SAU735



Front Back

SAU738  
SAU739

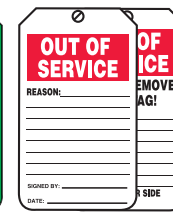

Front Back

SAU742  
SAU743

Material  
PF-Cardstock  
RV-Plastic

Material	Size*	Price/Pkg. 25
PF-Cardstock	5 7/8 x 3 1/8	33.50
RV-Plastic	5 7/8 x 3 3/8	83.90

Material  
PF-Cardstock  
RV-Plastic

**ACCUFORMNMC**  
Justrite Safety Group

## FRENCH BLANK HEADER TAGS



SED646  
SED647



SED648  
SED649



SED650  
SED651



SED652  
SED653

Material  
PF-Cardstock  
RV-Plastic

Material	Size"	Price/Pkg. 25
PF-Cardstock	5 7/8 x 3 1/8	33.50
RV-Plastic	5 7/8 x 3 3/8	83.90

**ACCUFORN<sup>TM</sup>NMC**  
Justrite Safety Group

## FRENCH STANDARD SAFETY TAGS



SAU834  
SAU835



SAU838  
SAU839



SAU846  
SAU847



SAU842  
SAU843



SAU858  
SAU859



SAU854  
SAU855



Standard French Back

Material  
PF-Cardstock  
RV-Plastic

## FRENCH EQUIPMENT STATUS & INSPECTION TAGS



SED654  
SED655

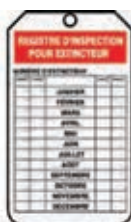

SED656  
SED657



SED658  
SED659



SED660  
SED661

Material  
PF-Cardstock  
RV-Plastic

## FRENCH LOCKOUT TAGS



SAU870  
SAU871



SAU874  
SAU875



SAU878  
SAU879



SAU882  
SAU883



Std. French Lockout Back

Material  
PF-Cardstock  
RV-Plastic

Material	Size"	Price/Pkg. 25
PF-Cardstock	5 7/8 x 3 1/8	33.50
RV-Plastic	5 7/8 x 3 3/8	83.90

**ACCUFORN<sup>TM</sup>NMC**  
Justrite Safety Group

# TAGS

## TAGS BY-THE-ROLL: NEVER RUN OUT OF TAGS AGAIN!

- Tag size: 6 1/4" x 3", with 3/8" hole
- 10-mil PF-Cardstock tags
- Tear-resistant, waterproof 'pulp-free' material
- Writable matte surface
- Dispenser size: 6 5/8" x 6 5/8" x 3 5/8"
- Available in rolls of 100 or 250 tags



Per Roll	Price/Roll
100	92.90
250	209.00



SAS784

### ENGLISH TAGS



Front Back  
100/Roll 250/Roll  
SAS755 SAS449

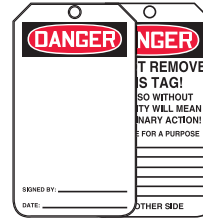

Front Back  
100/Roll 250/Roll  
SAS757 SAS782



Front Back  
100/Roll 250/Roll  
SAS783 SAS784



Front Back  
100/Roll 250/Roll  
SAS785 SAS764



Front Back  
100/Roll 250/Roll  
SEI937 SEI938



Front Back  
100/Roll 250/Roll  
SEI939 SEI940

### FRENCH TAGS (ROLLS OF 250 TAGS)

Model No.	Mfg. No.	Description
SAS452	TAR123	<i>Danger; Ne pas faire fonctionner</i>
SAS453	TAR127	<i>Danger; Ne pas faire fonctionner (w/Stripes)</i>
SGC242	FRTAR46	<i>Danger; Verrouillé; Ne pas faire fonctionner (w/Stripes)</i>

## LOOP 'N STRAP™ TAGS

- Attach tags by self-fastening strap for quick marking
- 0.023" polyethylene plastic tags resist dirt, grease and moisture
- Write on tag with permanent marker
- Tag body is 5 1/4" X 3 1/4", with 1 3/8" x 6" strap
- Available in packages of 25

Price/Pkg. of 25
83.90



### ENGLISH TAGS



SAS435 SAS747 SAS748 SAS749 SAS750

### FRENCH TAGS

Model No.	Mfg. No.	Description
SAS440	TAL357	<i>Danger; Ne Pas Entrer</i>
SAS441	TAL351	<i>Danger; Ne pas faire fonctionner</i>
SAS442	TAL356	<i>Danger; Hors service</i>
SAS443	TAL322	<i>Danger</i>
SAS444	TAL326	<i>Attention</i>

## TIES

### PLASTIC TAG FASTENERS

- 5" long
- 200/pkg.

Model No. S1980  
Price/Pkg. \$7.99

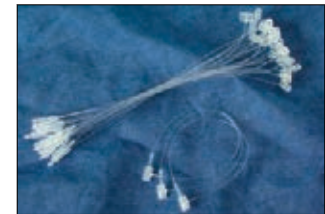

S1980

### WIRE TIES

- 26 gauge
- 12" long
- 1000/pkg.

Model No. SC960  
Price/Pkg. \$12.95



SC960



## BLANK TAGS

We offer tags available blank so that you can write any message in pen, pencil, or marker. Use for coding, marking, quick identification, production status, or inventory.

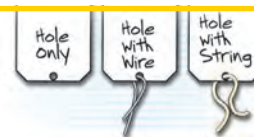

## MANILA BLANK CARDSTOCK TAGS

- 13 pt. Manila Cardstock Tags have patch-reinforced 3/16" hole
- Available plain hole, looped with 12" galvanized steel wire, or looped with 12" cotton string
- Available in pack of 100, or box of 1000

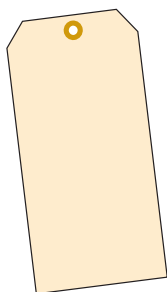

Hole Only Size No.	Size"	100	1000	Price 100/Pkg.	Price 1000/Box
1	2 3/4 x 1 3/8	SI966	SAG441	10.90	25.50
2	3 1/4 x 1 5/8	SAW514	SAG442	10.50	27.50
3	3 3/4 x 1 7/8	SI968	SAG443	11.90	27.90
4	4 1/4 x 2 1/8	SI969	SAG444	12.90	29.50
5	4 3/4 x 2 3/8	SI970	SAG445	13.90	31.90
6	5 1/4 x 2 5/8	SI971	SAG446	13.50	34.50
7	5 3/4 x 2 7/8	SAW515	SAG447	16.50	39.90
8	6 1/4 x 3 1/8	SAW516	SAG448	18.50	39.90

Hole with Wire Size No.	Size"	100	1000	Price 100/Pkg.	Price 1000/Box
1	2 3/4 x 1 3/8	SAW517	SAG449	21.50	92.50
2	3 1/4 x 1 5/8	SAW518	SAG450	27.90	97.90
3	3 3/4 x 1 7/8	SAW519	SAG451	21.90	94.50
4	4 1/4 x 2 1/8	SBB051	SAG452	24.50	96.50
5	4 3/4 x 2 3/8	SBB053	SAG453	22.90	98.50
6	5 1/4 x 2 5/8	SAW522	SAG454	25.90	105.00
7	5 3/4 x 2 7/8	SAW523	SAG455	27.90	109.00
8	6 1/4 x 3 1/8	SAW524	SAG456	28.90	109.00

Hole with String Size No.	Size"	100	1000	Price 100/Pkg.	Price 1000/Box
1	2 3/4 x 1 3/8	SAW525	SAG457	19.50	87.50
2	3 1/4 x 1 5/8	SAW526	SAG458	21.29	90.90
3	3 3/4 x 1 7/8	SAW527	SAG459	19.50	94.50
4	4 1/4 x 2 1/8	SAW528	SAG460	21.50	96.90
5	4 3/4 x 2 3/8	SAW529	SAG461	22.50	99.50
6	5 1/4 x 2 5/8	SAW530	SAG462	23.90	105.00
7	5 3/4 x 2 7/8	SAW531	SAG463	24.90	109.00
8	6 1/4 x 3 1/8	SAW532	SAG464	25.90	109.00

## STANDARD COLOR BLANK CARDSTOCK TAGS

- 13 pt. coated color cardstock tags have a patch-reinforced 3/16" hole
- Available plain hole, looped with 12" galvanized steel wire, or looped with 12" cotton string
- Available in pack of 100, or box of 1000

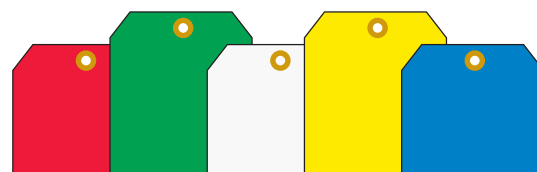

Hole Only Size No.	Size"	Blue		Green		Red		White		Yellow		Price 100/Pkg.	Price 1000/Box
		100	1000	100	1000	100	1000	100	1000	100	1000		
1	2 3/4 x 1 3/8	SAW536	SAG501	SAW560	SAG486	SAW584	SAG479	SAW608	SAG465	SAW632	SAG472	12.90	35.50
2	3 1/4 x 1 5/8	SAW537	SAG502	SAW561	SAG487	SAW585	SAG480	SAW609	SAG466	SAW633	SAG473	16.90	37.90
3	3 3/4 x 1 7/8	SAW538	SAG503	SAW562	SAG488	SAW586	SAG481	SAW610	SAG467	SAW634	SAG474	15.50	41.50
4	4 1/4 x 2 1/8	SAW539	SAG504	SAW563	SAG489	SAW587	SAG482	SAW611	SAG468	SAW635	SAG475	16.50	44.90
5	4 3/4 x 2 3/8	SAW540	SI978	SAW564	SI977	SAW588	SI976	SAW612	SI974	SAW636	SI975	18.50	46.70
6	5 1/4 x 2 5/8	SAW541	SAG505	SAW565	SAG490	SAW589	SAG483	SAW613	SAG469	SAW637	SAG476	19.90	54.50
7	5 3/4 x 2 7/8	SAW542	SAG506	SAW566	SAG491	SAW590	SAG484	SAW614	SAG470	SAW638	SAG477	24.49	58.90
8	6 1/4 x 3 1/8	SAW543	SAG507	SAW567	SAG492	SAW591	SAG485	SAW615	SAG471	SAW639	SAG478	24.90	63.90

Hole with Wire Size No.	Size"	Blue		Green		Red		White		Yellow		Price 100/Pkg.	Price 1000/Box
		100	1000	100	1000	100	1000	100	1000	100	1000		
1	2 3/4 x 1 3/8	SAW552	SAG555	SAW576	SAG539	SAW600	SAG531	SAW624	SAG515	SAW648	SAG523	20.89	119.00
2	3 1/4 x 1 5/8	SAW553	SAG556	SAW577	SAG540	SAW601	SAG532	SAW625	SAG516	SAW649	SAG524	27.29	125.00
3	3 3/4 x 1 7/8	SAW554	SAG557	SAW578	SAG541	SAW602	SAG533	SAW626	SAG517	SAW650	SAG525	25.90	129.00
4	4 1/4 x 2 1/8	SAW555	SAG558	SAW579	SAG542	SAW603	SAG534	SAW627	SAG518	SAW651	SAG526	27.50	129.00
5	4 3/4 x 2 3/8	SAW556	SAG559	SAW580	SAG543	SAW604	SAG535	SAW628	SAG519	SAW652	SAG527	28.90	135.00
6	5 1/4 x 2 5/8	SAW557	SAG560	SAW581	SAG544	SAW605	SAG536	SAW629	SAG520	SAW653	SAG528	31.50	145.00
7	5 3/4 x 2 7/8	SAW558	SAG561	SAW582	SAG545	SAW606	SAG537	SAW630	SAG521	SAW654	SAG529	41.90	145.00
8	6 1/4 x 3 1/8	SAW559	SAG562	SAW583	SAG546	SBB093	SAG538	SAW631	SAG522	SAW655	SAG530	35.90	149.00

Hole with String Size No.	Size"	Blue		Green		Red		White		Yellow		Price 100/Pkg.	Price 1000/Box
		100	1000	100	1000	100	1000	100	1000	100	1000		
1	2 3/4 x 1 3/8	SAW544	SAG611	SAW568	SAG595	SAW592	SAG587	SAW616	SAG571	SAW640	SAG579	18.79	109.00
2	3 1/4 x 1 5/8	SAW545	SAG612	SAW569	SAG596	SAW593	SAG588	SAW617	SAG572	SAW641	SAG580	27.50	115.00
3	3 3/4 x 1 7/8	SAW546	SAG613	SAW570	SAG597	SAW594	SAG589	SAW618	SAG573	SAW642	SAG581	23.90	115.00
4	4 1/4 x 2 1/8	SAW547	SAG614	SAW571	SAG598	SAW595	SAG590	SAW619	SAG574	SAW643	SAG582	24.90	119.00
5	4 3/4 x 2 3/8	SAW548	SAG615	SAW572	SAG599	SAW596	SAG591	SAW620	SAG575	SAW644	SAG583	25.90	125.00
6	5 1/4 x 2 5/8	SAW549	SAG616	SAW573	SAG600	SAW597	SAG592	SAW621	SAG576	SAW645	SAG584	28.50	129.00
7	5 3/4 x 2 7/8	SAW550	SAG617	SAW574	SAG601	SAW598	SAG593	SAW622	SAG577	SAW646	SAG585	26.59	129.00
8	6 1/4 x 3 1/8	SAW551	SAG618	SAW575	SAG602	SAW599	SAG594	SAW623	SAG578	SAW647	SAG586	32.90	135.00

# TAGS

## BLANK TAGS

- Identify equipment, materials and pipes by stamping description directly onto tag

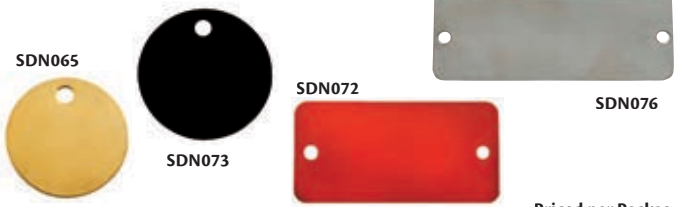

Priced per Package

Model No.	Mfg. No.	Material	Shape	Tag Size"	Hole Size"	Wt. lbs.	Qty /Pkg.	Price /Each
SA962	947B	Brass	Octagon	1 1/4	3/16	1.9	100	115.00
SDN075	41272	Brass	Rectangle	1 x 2	1/8	2.3	100	145.00
SDN077	41292	Brass	Rectangle	1 x 3	1/8	3.7	100	239.00
SA963	1098B	Brass	Round	1 1/2	3/16	2.2	100	129.00
SDN066	41842	Brass	Round	1 1/4	3/16	1.5	100	95.90
SDN067	41849	Brass	Round	1 3/8	3/8	2.9	100	155.00
SDN065	1078B	Brass	Round	1	3/16	0.87	100	54.50
SDN068	1110B	Brass	Round	2	3/16	3.8	100	210.00
SA961	916B	Brass	Square	1 1/4	3/16	1.9	100	118.00
SDN074	43169	Black Anodized Aluminum	Rectangle	1 x 3	1/8	0.056	5	19.90
SDN073	43147	Black Anodized Aluminum	Round	1 1/2	3/16	0.036	5	22.50
SDN072	43167	Red Anodized Aluminum	Rectangle	1 x 3	1/8	0.058	5	19.90
SDN071	43145	Red Anodized Aluminum	Round	1 1/2	3/16	0.036	5	22.50
SDN076	41273	Stainless Steel	Rectangle	1 x 2	1/8	1.9	100	105.00
SDN078	41293	Stainless Steel	Rectangle	1 x 3	1/8	2.9	100	109.00
SDN069	41858	Stainless Steel	Round	1 1/2	3/16	2.1	100	52.50
SDN070	41843	Stainless Steel	Round	1 1/4	3/16	1.3	100	52.90

## LEAD SECURITY SEALS & SEALING PRESSES

- Provides security in a wide variety of situations
- Slip twisted wire through the hole in lead seal disc and crush with sealing press
- Can't be opened or tampered with, without detection
- 7/16" diameter lead seals with 10" two-ply annealed steel wires
- Lead sealing press comes with two blank dies



Model No.	Mfg. No.	Description	Price /Each
SA947	27905	Sealing Press	159.00
SA948	27911	Seals, 100/pkg.	44.50

## NUMBERED BRASS TAGS

- Black filled numbers
- 18-gauge brass
- 3/16" hole
- Available only in unbroken series of 25



Priced per Series



Model No.	Mfg. No.	Number Series	Price /Each
1" TAG DIAMETER			
SDM709	40003	001 - 025	73.90
SDM710	40004	026 - 050	73.90
SDM711	40005	051 - 075	73.90
SDM712	40006	076 - 100	73.90
SDM713	40007	101 - 125	73.90
SDM714	40008	126 - 150	73.90
SDM715	40009	151 - 175	73.90
SDM716	40010	176 - 200	73.90

Model No.	Mfg. No.	Number Series	Price /Each
1.5" TAG DIAMETER			
SA949	40023	001 - 025	115.00
SA950	40024	026 - 050	115.00
SA951	40025	051 - 075	115.00
SA952	40026	076 - 100	115.00
SA953	40027	101 - 125	115.00
SA954	40028	126 - 150	115.00
SA955	40029	151 - 175	115.00
SA956	40030	176 - 200	115.00

## SPLIT KEY RINGS

Designed for holding and preventing the loss of metal checks and tags.



Price per Package

Model No.	Mfg. No.	Description	Qty /Pkg.	Price /Each
SA957	40082	1" Ring	100	40.90
SA958	40084	1 1/2" Ring	100	93.90
SA959	40085	2" Ring	100	135.00
SA960	40087	Spring Sleeve	100	149.00

## BEADED CHAINS

- For quick, permanent fastening of checks and tags
- Easily closed by hand
- Flexible for hard-to-fasten places
- Available in 4 1/2" nickel or brass plated or 6" brass plated
- 100/pkg.



Priced per Package

Model No.	Mfg. No.	Description	Length"	Price /Each
SAG886	40096	Nickel Plated	4 1/2	22.50
SAG887	40097	Brass Plated	4 1/2	26.50
SAG888	40098	Brass Plated	6	36.90



## STEEL HAND STAMPS

- For hand-held, hammer struck applications
- Manufactured from high quality steel
- Induction hardened for added durability and extended life
- Bevelled striking edge prevents breakage and accidents during use
- Stamping end is hardened at 58-62 HRC and the striking end is hardened to 38-43 HRC to prevent splintering
- Letter sets contain 27 pieces, "A" through "Z" and "&"-ampersand
- Number sets contain 9 pieces, "0" through "9", numbers "6" and "9" are interchangeable



**AURORA**  
TOOLS

Model No.	Stamp Size"	Type	Price /Each
TLZ389	1/8	Number	14.50
TLZ392	1/8	Letter	40.10
TLZ390	3/16	Number	23.55
TLZ393	3/16	Letter	57.25
TLZ391	1/4	Number	30.65
TLZ394	1/4	Letter	74.90

## STEEL HAND STAMP SETS

FOR HAND-HELD HAMMER STRUCK APPLICATIONS



### STANDARD STEEL STAMPS

- Standard high quality stamps for general purpose uses at low cost
- Crowned striking surface
- Textured shank



### HEAVY-DUTY STAMPS

- Heavy-duty marking performance
- Tempered shanks for extra durability and safety
- Crowned striking surface
- Larger shanks than standard



### PREMIER TEMPERED STAMPS

- Large shanks are tempered designed to hold up under continuous hard hammering
- Top quality tempered shanks



### ROUND FACE LOW STRESS STAMPS

- Rounded characters produce minimum stress on the marked surface
- Meets government specifications for minimum stress marking
- Crowned striking surface
- Textured shanks
- Larger shanks than heavy-duty



### LOW STRESS DOT DESIGN STAMPS

- Made on premier size shanks
- Interrupted dot design has a radius on the character end
- Make a permanent mark with minimum stress on the marked metal
- Meets U.S. Atomic Energy specifications
- Applications where metal strength and/or risk of fracture is critical
- Ideal for use in aircraft, missile, oil supply and nuclear power



Model No.	Mfg. No.	Size"	Type	Dimensions Sq." x L"	Wt. lbs.	Price /Each
<b>STANDARD GENERAL PURPOSE</b>						
SF090	20150	3/32	Letters	1/4 x 2-3/8	1.50	95.90
SF091	20521	3/32	Numbers	1/4 x 2-3/8	0.50	29.50
SE234	20200	1/8	Letters	1/4 x 2-3/8	1.50	95.90
SE235	20541	1/8	Numbers	1/4 x 2-3/8	0.50	29.50
SE236	20250	3/16	Letters	5/16 x 2-3/8	2.13	119.00
SE237	20561	3/16	Numbers	5/16 x 2-3/8	0.75	36.90
SE238	20300	1/4	Letters	3/8 x 2-5/8	3.00	149.00
SE239	20581	1/4	Numbers	3/8 x 2-5/8	1.13	44.50
SAK459	20350	3/8	Letters	1/2 x 2-3/4	6.00	225.00
SAK460	20601	3/8	Numbers	1/2 x 2-3/4	2.00	66.50
SF092	20400	1/2	Letters	5/8 x 3	10.00	295.00
SF093	20621	1/2	Numbers	5/8 x 3	3.25	115.00
<b>HEAVY-DUTY</b>						
SF082	20801	3/32	Letters	5/16 x 2-1/2	2.25	179.00
SF083	21340	3/32	Numbers	5/16 x 2-1/2	0.88	73.90
SA932	20851	1/8	Letters	5/16 x 2-1/2	2.30	179.00
SA935	21360	1/8	Numbers	5/16 x 2-1/2	0.88	73.90
SA933	20951	3/16	Letters	3/8 x 2-3/4	3.30	225.00
SA936	21400	3/16	Numbers	3/8 x 2-3/4	1.10	76.90
SA934	21051	1/4	Letters	7/16 x 3	5.00	269.00
SA937	21440	1/4	Numbers	7/16 x 3	1.80	88.50
SF084	21201	1/2	Letters	3/4 x 3-3/4	17.00	635.00
SF085	21500	1/2	Numbers	3/4 x 3-3/4	2.63	199.00
<b>ROUND FACE LOW STRESS</b>						
SF094	25750	3/32	Letters	5/16 x 2-3/4	2.38	229.00
SF095	26081	3/32	Numbers	5/16 x 2-3/4	0.88	73.90
SF096	25800	1/8	Letters	3/8 x 2-3/4	3.25	239.00
SF097	26101	1/8	Numbers	3/8 x 2-3/4	1.25	73.90
SF098	25850	3/16	Letters	7/16 x 2-3/4	3.50	289.00
SF099	26121	3/16	Numbers	7/16 x 2-3/4	1.38	88.50
SF100	25900	1/4	Letters	1/2 x 3	6.00	355.00
SF101	26141	1/4	Numbers	1/2 x 3	2.25	115.00
SF102	26000	1/2	Letters	3/4 x 4	18.25	809.00
SF103	26181	1/2	Numbers	3/4 x 4	6.00	255.00
SAS103	25950	3/8"	Letters	5/8 x 3-1/8	10.50	559.00
SAS104	26161	3/8"	Numbers	5/8 x 3-1/8	3.50	179.00
<b>LOW STRESS DOT DESIGN</b>						
SAS093	26200	1/8	Letters	3/8 x 2-3/4	3.25	295.00
SAS094	26601	1/8	Numbers	3/8 x 2-3/4	1.25	95.90
SAS095	26250	3/16	Letters	7/16 x 2-3/4	3.5	355.00
SAS096	26621	3/16	Numbers	7/16 x 2-3/4	1.38	119.00
SAS097	26300	1/4	Letters	1/2 x 3	6.00	475.00
SAS098	26641	1/4	Numbers	1/2 x 3	2.25	149.00
SAS099	26350	3/8	Letters	5/8 x 3-1/8	10.50	739.00
SAS100	26661	3/8	Numbers	5/8 x 3-1/8	3.50	225.00
SAS101	26400	1/2	Letters	3/4 x 4	18.25	1035.00
SAS102	26681	1/2	Numbers	3/4 x 4	6.00	339.00

Call us for more information!

Grade of Stamp	Frequency of Use	Material Being Marked								
		Wood	Leather	Aluminum	Brass	Sheet Metal	Cold Roll Steel	Stainless Steel	Wet/Dry Hardened Steel	Heat Treated Material up to 500F
Standard	Occasional	○	○	○	○	○	○			
Heavy Duty	Moderate	◐	◐	◐	◐	◐	◐			
Premier	Every Day	◑	◑	◑	◑	◑	◑	○		
Rhino	High Volume	●	●	●	●	●	●	●	●	●

Not recommended  Good  Better  Best





## QUICK REFERENCE CHART

MATERIAL	Thickness	Flexibility	Mounting Type	Product Use	UV Resistance
Vinyl (Adhesive Vinyl)	0.004"	Flexible	Adhesive backed vinyl	Indoor or short term use outdoor	1 to 3 years outdoors
Plastic (Semi-Rigid Plastic)	0.055"	Semi-Rigid	Pre-drilled mounting holes	Indoor or short term use outdoor	1 to 3 years outdoors
Alum. (Aluminum)	0.040"	Rigid	Pre-drilled mounting holes	Indoor or short term use outdoor	1 to 3 years outdoors

## MATERIAL

- **Coating:** Weather and abrasion resistant coating for indoor/outdoor durability. Helps resist fading, peeling and abrasion.
- **Use:** Indoor or short term use outdoor
- **UV Resistance:** 1 to 3 years outdoors

### Vinyl - Adhesive Vinyl

- **Thickness:** 0.004"
- **Material:** Permanent adhesive backed vinyl
- **Mounting Type:** Adhesive

### Plastic - Semi-Rigid Plastic

- **Thickness:** 0.055"
- **Material:** HDPE semi-rigid plastic
- **Mounting Type:** Pre-drilled mounting holes

### Alum. – Aluminum

- **Thickness:** 0.040"
- **Material:** Aluminum
- **Mounting Type:** Pre-drilled mounting holes

## CUSTOM SIGNS

**Need a different size?  
Interested in a different material?**  
We can make that happen!  
Simply send us the dimensions, material, wording, and any other important information.

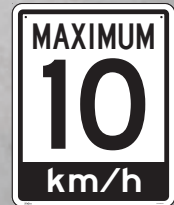

## CSA SAFETY SIGNS

CSA (Canadian Standards Association) signs follow a standard look which includes specific colors & geometrical shapes. These help distinguish the type of safety categories.

### REGULATORY



#### PROHIBITION

Used to show a forbidden action.

**Colours**  
Red Circle with white border and red bar over black pictogram on white background.

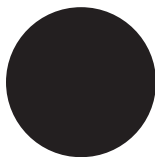

#### MANDATORY

Used to show a required or mandatory action.

**Colours**  
White pictogram on black background with white border.

### WARNING



#### CAUTION

Used to show a potential hazard.

**Colours**  
Black pictogram on yellow background with black border.



#### DANGER

Used to show a definite hazard.

**Colours**  
White pictogram on red background with white border.

### INFORMATION



#### EMERGENCY

Used to show first aid, health, fire protection, fire fighting, and emergency equipment.

**Colours**  
White pictogram on green background with white border.



#### GENERAL INFORMATION

Used to show Public Information.

**Colours**  
White pictogram on blue background with white border.

## ADMITTANCE & EXIT



Material	7" x 10"	10" x 14"	7" x 10"	10" x 14"	7" x 10"	10" x 14"	7" x 10"	10" x 14"	7" x 10"	10" x 14"	7" x 10"	10" x 14"	
	Vinyl	SGL335	SGL338	SGL341	SGL344	SGL347	SGL350	SGL353	SGL356	SGL359	SGL362	SGL365	SGL368
	Plastic	SGL336	SGL339	SGL342	SGL345	SGL348	SGL351	SGL354	SGL357	SGL360	SGL363	SGL366	SGL369
Alum.	SGL337	SGL340	SGL343	SGL346	SGL349	SGL352	SGL355	SGL358	SGL361	SGL364	SGL367	SGL370	

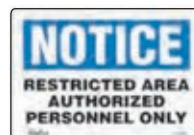
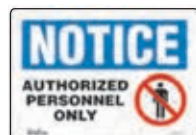

Material	7" x 10"	10" x 14"	7" x 10"	10" x 14"	7" x 10"	10" x 14"	7" x 10"	10" x 14"	7" x 10"	10" x 14"	7" x 10"	10" x 14"	
	Vinyl	SGL371	SGL374	SGL377	SGL380	SGL383	SGL386	SGL389	SGL392	SGL395	SGL398	SGL401	SGL404
	Plastic	SGL372	SGL375	SGL378	SGL381	SGL384	SGL387	SGL390	SGL393	SGL396	SGL399	SGL402	SGL405
Alum.	SGL373	SGL376	SGL379	SGL382	SGL385	SGL388	SGL391	SGL394	SGL397	SGL400	SGL403	SGL406	

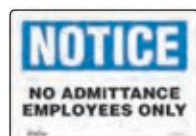

Material	7" x 10"	10" x 14"	7" x 10"	10" x 14"	7" x 10"	10" x 14"	7" x 10"	10" x 14"	7" x 10"	10" x 14"	7" x 10"	10" x 14"	
	Vinyl	SGL407	SGL410	SGL413	SGL416	SGL419	SGL422	SGL425	SGL428	SGL431	SGL434	SGL437	SGL440
	Plastic	SGL408	SGL411	SGL414	SGL417	SGL420	SGL423	SGL426	SGL429	SGL432	SGL435	SGL438	SGL441
Alum.	SGL409	SGL412	SGL415	SGL418	SGL421	SGL424	SGL427	SGL430	SGL433	SGL436	SGL439	SGL442	



Material	7" x 10"	10" x 14"	7" x 10"	10" x 14"	7" x 10"	10" x 14"	7" x 10"	10" x 14"	7" x 10"	10" x 14"	7" x 10"	10" x 14"	
	Vinyl	SGL443	SGL446	SGL449	SGL452	SGL455	SGL458	SGL461	SGL464	SGL467	SGL470	SGL527	SGL530
	Plastic	SGL444	SGL447	SGL450	SGL453	SGL456	SGL459	SGL462	SGL465	SGL468	SGL471	SGL528	SGL531
Alum.	SGL445	SGL448	SGL451	SGL454	SGL457	SGL460	SGL463	SGL466	SGL469	SGL472	SGL529	SGL532	



Material	7" x 10"	10" x 14"	7" x 10"	10" x 14"	7" x 10"	10" x 14"	7" x 10"	10" x 14"	7" x 10"	10" x 14"	7" x 10"	10" x 14"	
	Vinyl	SGL611	SGL614	SGL635	SGL638	SGM052	SGM055	SGM058	SGM061	-	-	SGM175	SGM177
	Plastic	SGL612	SGL615	SGL636	SGL639	SGM053	SGM056	SGM059	SGM062	SGM163	SGM165	SGM176	SGM178
Alum.	SGL613	SGL616	SGL637	SGL640	SGM054	SGM057	SGM060	SGM063	SGM164	SGM166	-	-	



Material	7" x 10"	10" x 14"	7" x 10"	10" x 14"	7" x 10"	10" x 14"	7" x 10"	10" x 14"	7" x 10"	10" x 14"	7" x 10"	10" x 14"	
	Vinyl	SGM257	SGM260	SGM263	SGM266	SGM269	SGM272	SGM275	SGM278	SGM281	SGM284	SGM287	SGM290
	Plastic	SGM258	SGM261	SGM264	SGM267	SGM270	SGM273	SGM276	SGM279	SGM282	SGM285	SGM288	SGM291
Alum.	SGM259	SGM262	SGM265	SGM268	SGM271	SGM274	SGM277	SGM280	SGM283	SGM286	SGM289	SGM292	

Material	7" x 10"	10" x 14"
Vinyl	10.10	15.15
Plastic	11.00	16.45
Alum.	24.95	39.95

# SIGNS

## ADMITTANCE & EXIT (CONTINUED)



Material	7" x 10"	10" x 14"	7" x 10"	10" x 14"	7" x 10"	10" x 14"	7" x 10"	10" x 14"	7" x 10"	10" x 14"
Vinyl	SGM293	SGM296	SGM299	SGM302	SGM305	SGM308	SGM469	SGM472	SGM601	SGM604
Plastic	SGM294	SGM297	SGM300	SGM303	SGM306	SGM309	SGM470	SGM473	SGM602	SGM605
Alum.	SGM295	SGM298	SGM301	SGI146	SGM307	SGM310	SGM471	SGM474	SGM603	SGM667

## CHEMICALS & HAZARDOUS MATERIALS



Material	7" x 10"	10" x 14"	7" x 10"	10" x 14"	7" x 10"	10" x 14"	7" x 10"	10" x 14"	7" x 10"	10" x 14"	7" x 10"	10" x 14"
Vinyl	SGL533	SGL536	SGL539	SGL542	SGL545	SGL548	SGL551	SGL554	SGL557	SGL560	SGL563	SGL566
Plastic	SGL534	SGL537	SGL540	SGL543	SGL546	SGL549	SGL552	SGL555	SGL558	SGL561	SGL564	SGL567
Alum.	SGL535	SGL538	SGL541	SGL544	SGL547	SGL550	SGL553	SGL556	SGL559	SGL562	SGL565	SGL568



Material	7" x 10"	10" x 14"	7" x 10"	10" x 14"	7" x 10"	10" x 14"	7" x 10"	10" x 14"	7" x 10"	10" x 14"	7" x 10"	10" x 14"
Vinyl	SGL569	SGL572	SGL581	SGL584	SGL587	SGL590	SGM127	SGM130	SGM311	SGM314	SGM317	SGI138
Plastic	SGL570	SGL573	SGL582	SGL585	SGL588	SGL591	SGM128	SGM131	SGM312	SGM315	SGM318	SGM321
Alum.	SGL571	SGL574	SGL583	SGL586	SGL589	SGL592	SGM129	SGM132	SGM313	SGM316	SGM319	SGM322



Material	7" x 10"	10" x 14"	7" x 10"	10" x 14"	7" x 10"	10" x 14"	7" x 10"	10" x 14"	7" x 10"	10" x 14"	7" x 10"	10" x 14"
Vinyl	SGM323	SGM326	SGM329	SGM332	SGM335	SGM338	SGM341	SGM344	SGL575	SGI139	SGM577	SGM580
Plastic	SGM324	SGM327	SGM330	SGM333	SGM336	SGM339	SGM342	SGM345	SGL576	SGL579	SGM578	SGM581
Alum.	SGM325	SGM328	SGM331	SGM334	SGM337	SGM340	SGM343	SGM346	SGL577	SGL580	SGM579	SGM582

## SMOKING CONTROL



Material	7" x 10"	10" x 14"	7" x 10"	10" x 14"	7" x 10"	10" x 14"	7" x 10"	10" x 14"	7" x 10"	10" x 14"	7" x 10"	10" x 14"
Vinyl	SGL575	SGI139	SGL943	SGL946	SGL949	SGL952	SGL955	SGL958	SGL973	SGL976	SGL979	SGL982
Plastic	SGL576	SGL579	SGL944	SGL947	SGL950	SGL953	SGL956	SGL959	SGL974	SGL977	SGL980	SGL983
Alum.	SGL577	SGL580	SGL945	SGL948	SGL951	SGL954	SGL957	SGL960	SGL975	SGL978	SGL981	SGL984

Material	7" x 10"	10" x 14"
Vinyl	10.10	15.15
Plastic	11.00	16.45
Alum.	24.95	39.95





## SMOKING CONTROL (CONTINUED)



Material	7" x 10"	10" x 14"	10" x 7"	14" x 10"	7" x 10"	10" x 14"	7" x 10"	10" x 14"	7" x 10"	10" x 14"	7" x 10"	10" x 14"
Vinyl	SGL985	SGL988	SGL991	SGL994	SGL997	SGM001	SGM571	SGM574	SGM577	SGM580	SGM583	SGM586
Plastic	SGL986	SGL989	SGL992	SGL995	SGL998	SGM002	SGM572	SGM575	SGM578	SGM581	SGM584	SGM587
Alum.	SGL987	SGL990	SGL993	SGL996	SGL999	SGM003	SGM573	SGM576	SGM579	SGM582	SGM585	SGM588

## FIRST AID



Material	7" x 10"	10" x 14"	7" x 10"	10" x 14"	7" x 10"	10" x 14"	7" x 10"	10" x 14"	7" x 10"	10" x 14"	7" x 10"	10" x 14"
Vinyl	SGL701	SGL704	SGL713	SGL716	SGL719	SGL722	SGL725	SGL728	SGL731	SGL734	SGL743	SGL746
Plastic	SGL702	SGL705	SGL714	SGL717	SGL720	SGL723	SGL726	SGL729	SGL732	SGL735	SGL744	SGL747
Alum.	SGL703	SGL706	SGL715	SGL718	SGL721	SGL724	SGL727	SGL730	SGL733	SGL736	SGL745	SGL748



Material	7" x 10"	10" x 14"	10" x 7"	14" x 10"	7" x 10"	10" x 14"	10" x 7"	14" x 10"	10" x 7"	14" x 10"	18" x 4"
Vinyl	SGL749	SGL752	SGL755	SGL758	SGL761	SGL764	SGL767	SGL770	SGL773	SGL776	SGL707
Plastic	SGL750	SGL753	SGL756	SGL759	SGL762	SGL765	SGL768	SGL771	SGL774	SGL777	SGL708
Alum.	SGL751	SGL754	SGL757	SGL760	SGL763	SGL766	SGL769	SGL772	SGL775	SGL778	-



Material	7" x 10"	10" x 14"	10" x 7"	14" x 10"	7" x 10"	10" x 14"	10" x 7"	14" x 10"	10" x 7"	14" x 10"	10" x 7"	14" x 10"
Vinyl	SGM475	SGM478	SGM481	SGM484	SGM487	SGM490	SGM493	SGM496	SGM499	SGM502	SGM505	SGM508
Plastic	SGM476	SGM479	SGM482	SGM485	SGM488	SGM491	SGM494	SGM497	SGM500	SGM503	SGM506	SGM509
Alum.	SGM477	SGM480	SGM483	SGM486	SGM489	SGM492	SGM495	SGM498	SGM501	SGM504	SGM507	SGM510

## SAFETY INCENTIVE



Material	7" x 10"	10" x 14"	7" x 10"	10" x 14"	7" x 10"	10" x 14"
Vinyl	SGL961	SGL964	SGL967	SGL970	SGM565	SGM568
Plastic	SGL962	SGL965	SGL968	SGL971	SGM566	SGM569
Alum.	SGL963	SGL966	SGL969	SGL972	SGM567	SGM570

Material	7" x 10"	10" x 14"	10" x 7"	14" x 10"	18" x 4"
Vinyl	10.10	15.15	10.10	15.15	14.95
Plastic	11.00	16.45	11.00	16.45	16.60
Alum.	24.95	39.95	24.95	39.95	-

# SIGNS

## PERSONAL PROTECTION

<b>Material</b>	7" x 10"	10" x 14"	7" x 10"	10" x 14"	7" x 10"	10" x 14"
Vinyl	SGL877	SGL880	SGL883	SGL886	SGL889	SGL892
Plastic	SGL878	SGL881	SGL884	SGL887	SGL890	SGL893
Alum.	SGL879	SGL882	SGL885	SGL888	SGL891	SGL894

<b>Material</b>	7" x 10"	10" x 14"	7" x 10"	10" x 14"	7" x 10"	10" x 14"
Vinyl	SGL913	SGL916	SGL919	SGL922	SGL925	SGL928
Plastic	SGL914	SGL917	SGL920	SGL923	SGL926	SGL929
Alum.	SGL915	SGL918	SGL921	SGL924	SGL927	SGL930

<b>Material</b>	7" x 10"	10" x 14"	7" x 10"	10" x 14"	7" x 10"	10" x 14"
Vinyl	SGM529	SGM532	SGM535	SGM538	SGM541	SGM544
Plastic	SGM530	SGM533	SGM536	SGM539	SGM542	SGM545
Alum.	SGM531	SGM534	SGM537	SGM540	SGM543	SGM546

## ELECTRICAL

<b>Material</b>	7" x 10"	10" x 14"	7" x 10"	10" x 14"	7" x 10"	10" x 14"
Vinyl	SGL617	SGL620	SGL623	SGL626	SGL629	SGL632
Plastic	SGL618	SGL621	SGL624	SGL627	SGL630	SGL633
Alum.	SGL619	SGL622	SGL625	SGL628	SGL631	SGL634

<b>Material</b>	7" x 10"	10" x 14"	7" x 10"	10" x 14"	7" x 10"	10" x 14"
Vinyl	SGL659	SGL662	SGL665	SGL668	SGL671	SGL674
Plastic	SGL660	SGL663	SGL666	SGL669	SGL672	SGL675
Alum.	SGL661	SGL664	SGL667	SGL670	SGL673	SGL676

<b>Material</b>	7" x 10"	10" x 14"	7" x 10"	10" x 14"
Vinyl	SGM389	SGM392	SGM395	SGM398
Plastic	SGM390	SGM393	SGM396	SGM399
Alum.	SGM391	SGM394	SGM397	SGM400

Material	7" x 10"	10" x 14"
Vinyl	10.10	15.15
Plastic	11.00	16.45
Alum.	24.95	39.95



## FIRE & EMERGENCY



Material	7" x 10"	10" x 14"
	SGM064	SGM067
	Plastic	SGM065 SGM068
	Alum.	SGM066 SGM069



Material	7" x 10"	10" x 14"
	SGM070	SGM073
	Plastic	SGM071 SGM074
	Alum.	SGM072 SGM075



Material	7" x 10"	10" x 14"
	SGM076	SGM079
	Plastic	SGM077 SGM080
	Alum.	SGM078 SGM081



Material	7" x 10"	10" x 14"
	SGM082	SGM085
	Plastic	SGM083 SGM086
	Alum.	SGM084 SGM087



Material	7" x 10"	10" x 14"
	SGM088	SGM091
	Plastic	SGM089 SGM092
	Alum.	SGM090 SGM093



Material	7" x 10"	10" x 14"
	SGM094	SGM097
	Plastic	SGM095 SGM098
	Alum.	SGM096 SGM099



Material	10" x 7"	14" x 10"
	SGM100	SGM103
	Plastic	SGM101 SGM104
	Alum.	SGM102 SGM105



Material	10" x 7"	14" x 10"
	SGM106	SGM109
	Plastic	SGM107 SGM110
	Alum.	SGM108 SGM111



Material	7" x 10"	10" x 14"
	SGM112	SGM115
	Plastic	SGM113 SGM116
	Alum.	SGM114 SGM117



Material	12" x 4"	18" x 4"
	SGM118	SGM121
	Plastic	SGM119 SGM122
	Alum.	-



Material	18" x 4"	
	SGM124	
	Plastic	SGM125
	Alum.	-



Material	10" x 7"	14" x 10"
	SGP174	SGP177
	Plastic	SGP175 SGP178
	Alum.	SGP176 SGP179



Material	7" x 10"	10" x 14"
	SGM607	SGM610
	Plastic	SGM608 SGM611
	Alum.	SGM609 SGM612



Material	7" x 10"	10" x 14"
	SGM613	SGM616
	Plastic	SGM614 SGM617
	Alum.	SGM615 SGM618



Material	7" x 10"	10" x 14"
	SGM619	SGM622
	Plastic	SGM620 SGM623
	Alum.	SGM621 SGM624



Material	7" x 10"	10" x 14"
	SGM625	SGM628
	Plastic	SGM626 SGM629
	Alum.	SGM627 SGM630



Material	7" x 10"	10" x 14"
	SGM631	SGM634
	Plastic	SGM632 SGM635
	Alum.	SGM633 SGM636



Material	10" x 7"	14" x 10"
	SGM637	SGM640
	Plastic	SGM638 SGM641
	Alum.	SGM639 SGM642



Material	10" x 7"	14" x 10"
	SGM643	SGM646
	Plastic	SGM644 SGM647
	Alum.	SGM645 SGM648



Material	10" x 7"	14" x 10"
	SGM649	SGM652
	Plastic	SGM650 SGM653
	Alum.	SGM651 SGM654



Material	10" x 7"	14" x 10"
	SGM655	SGM658
	Plastic	SGM656 SGM659
	Alum.	SGM657 SGM660



Material	7" x 10"	10" x 14"
	SGM661	SGM664
	Plastic	SGM662 SGM665
	Alum.	SGM663 SGM666



Material	12" x 4"	
	SGM672	
	Plastic	-
	Alum.	-



Material	10" x 7"	14" x 10"
	SGP180	SGP183
	Plastic	SGP181 SGP184
	Alum.	SGP182 SGP185

## INDUSTRIAL TRAFFIC



Material	7" x 10"	10" x 14"
	SGM004	SGM007
	Plastic	SGM005 SGM008
	Alum.	SGM006 SGM009



Material	7" x 10"	10" x 14"
	SGM010	SGM013
	Plastic	SGM011 SGM014
	Alum.	SGM012 SGM015



Material	7" x 10"	10" x 14"
	SGM016	SGM019
	Plastic	SGM017 SGM020
	Alum.	SGM018 SGM021



Material	7" x 10"	10" x 14"
	SGM022	SGM025
	Plastic	SGM023 SGM026
	Alum.	SGM024 SGM027



Material	7" x 10"	10" x 14"
	SGM028	SGM031
	Plastic	SGM029 SGM032
	Alum.	SGM030 SGM033



Material	7" x 10"	10" x 14"
	SGM034	SGM037
	Plastic	SGM035 SGM038
	Alum.	SGM036 SGM039



Material	7" x 10"	10" x 14"
	SGM040	SGM043
	Plastic	SGM041 SGM044
	Alum.	SGM042 SGM045



Material	7" x 10"	10" x 14"
	SGM046	SGM049
	Plastic	SGM047 SGM050
	Alum.	SGM048 SGM051



Material	7" x 10"	10" x 14"
	SGM589	SGM592
	Plastic	SGM590 SGM593
	Alum.	SGM591 SGM594



Material	7" x 10"	10" x 14"
	SGM595	SGM598
	Plastic	SGM596 SGM599
	Alum.	SGM597 SGM600

Material	7" x 10"	10" x 14"	10" x 7"	14" x 10"	12" x 4"	18" x 4"
Vinyl	10.10	15.15	10.10	15.15	9.65	14.95
Plastic	11.00	16.45	11.00	16.45	12.55	16.60
Alum.	24.95	39.95	24.95	39.95	-	-



# SIGNS

## CONFINED SPACE



Material	7" x 10"	10" x 14"	7" x 10"	10" x 14"	7" x 10"	10" x 14"	7" x 10"	10" x 14"	7" x 10"	10" x 14"	7" x 10"	10" x 14"
Vinyl	SGL593	SGL596	SGL599	SGL602	SGL689	SGL692	SGM347	SGM350	SGM353	SGM356	SGM359	SGM362
Plastic	SGL594	SGL597	SGL600	SGL603	SGL690	SGL693	SGM348	SGM351	SGM354	SGM357	SGM360	SGM363
Alum.	SGL595	SGL598	SGL601	SGL604	SGL691	SGL694	SGM349	SGM352	SGM355	SGM358	SGM361	SGM364

## EQUIPMENT



Material	7" x 10"	10" x 14"
Vinyl	SGM365	SGM368
Plastic	SGM366	SGM369
Alum.	SGM367	SGM370

Material	7" x 10"	10" x 14"	7" x 10"	10" x 14"	7" x 10"	10" x 14"	7" x 10"	10" x 14"
Vinyl	SGL671	SGL674	SGL677	SGL680	SGL683	SGL686	SGL695	SGL698
Plastic	SGL672	SGL675	SGL678	SGL681	SGL684	SGL687	SGL696	SGL699
Alum.	SGL673	SGL676	SGL679	SGL682	SGL685	SGL688	SGL697	SGL700



Material	7" x 10"	10" x 14"	7" x 10"	10" x 14"	7" x 10"	10" x 14"	7" x 10"	10" x 14"	7" x 10"	10" x 14"
Vinyl	SGM457	SGM460	SGM463	SGM466	SGM445	SGM448	SGM451	SGM454	SGL689	SGL892
Plastic	SGM458	SGM461	SGM464	SGM467	SGM446	SGM449	SGM452	SGM455	SGL890	SGL893
Alum.	SGM459	SGM462	SGM465	SGM468	SGM447	SGM450	SGM453	SGM456	SGL891	SGL894

## HOUSEKEEPING & HYGIENE



Material	7" x 10"	10" x 14"	7" x 10"	10" x 14"	7" x 10"	10" x 14"	7" x 10"	10" x 14"	7" x 10"	10" x 14"	14" x 10"	14" x 10"
Vinyl	SGM133	SGM136	SGM139	SGM142	SGM145	SGM148	SGM151	SGM154	SGM157	SGM160	-	-
Plastic	SGM134	SGM137	SGM140	SGM143	SGM146	SGM149	SGM152	SGM155	SGM158	SGM161	SGM167	SGM169
Alum.	SGM135	SGM138	SGM141	SGM144	SGM147	SGM150	SGM153	SGM156	SGM159	SGM162	SGM168	SGM170



Material	7" x 10"	10" x 14"	14" x 10"	14" x 10"	14" x 10"	14" x 10"
Vinyl	SGM511	SGM514	-	-	-	-
Plastic	SGM512	SGM515	SGM179	SGM181	SGM187	SGM189
Alum.	SGM513	SGM516	SGM180	SGM182	SGM188	SGM190

Material	7" x 10"	10" x 14"	14" x 10"
Vinyl	10.10	15.15	-
Plastic	11.00	16.45	16.45
Alum.	24.95	39.95	39.95





## PERSONAL PROTECTION

												
<b>Material</b>	14" x 10"	14" x 10"	14" x 10"	14" x 10"	14" x 10"	14" x 10"	14" x 10"	14" x 10"	14" x 10"	14" x 10"		
Vinyl	SGM673	SGM676	SGM679	SGM682	SGI140	SGM688	SGM691	SGM694	SGM697	SGM700		
Plastic	SGM674	SGI144	SGM680	SGM683	SGM686	SGI142	SGM692	SGM695	SGM698	SGM701		
Alum.	SGM675	SGM678	SGM681	SGM684	SGI147	SGM690	SGM693	SGM696	SGM699	SGM702		
												
<b>Material</b>	14" x 10"	14" x 10"	14" x 10"	14" x 10"	14" x 10"	6"	12"	6"	12"	6"	12"	
Vinyl	SGM703	SGM706	SGM709	SGM712	SGM715	SGM820	SGM823	SGM826	SGM829	SGM832	SGM835	
Plastic	SGM704	SGM707	SGM710	SGI143	SGI141	SGM821	SGM824	SGM827	SGM830	SGM833	SGM836	
Alum.	SGM705	SGM708	SGM711	SGM714	SGM717	-	-	-	-	-	-	
												
<b>Material</b>	6"	12"	6"	12"	6"	12"	6"	12"	6"	12"		
Vinyl	SGM844	SGM847	SGM850	SGM853	SGM856	SGM859	SGM862	SGM865	SGM868	SGM871	SGN111	SGN114
Plastic	SGM845	SGM848	SGM851	SGM854	SGM857	SGM860	SGM863	SGM866	SGM869	SGM872	SGN112	SGN115
Alum.	-	-	-	-	-	-	-	-	-	-	-	-

## SMOKING CONTROL

								
<b>Material</b>	14" x 10"	14" x 10"	6"	12"	6"	12"	6"	12"
Vinyl	SGM721	SGM724	SGM802	SGM805	SGM808	SGM811	SGN141	SGN144
Plastic	SGM722	SGM725	SGM803	SGM806	SGM809	SGM812	SGN142	SGN145
Alum.	SGM723	SGM726	-	-	-	-	-	-

## ADMITTANCE & EXIT

			
<b>Material</b>	14" x 10"	6"	12"
Vinyl	SGM718	SGM790	SGM793
Plastic	SGM719	SGM791	SGM794
Alum.	SGM720	-	-

## CHEMICAL & HAZARDOUS MATERIALS

									
<b>Material</b>	14" x 10"	14" x 10"	14" x 10"	14" x 10"	14" x 10"	14" x 10"	14" x 10"	6"	12"
Vinyl	SGM727	SGM730	SGM733	SGM736	SGM739	SGM751	SGM754	SGM886	SGM889
Plastic	SGM728	SGM731	SGM734	SGM737	SGM740	SGM752	SGM755	SGM887	SGM890
Alum.	SGM729	SGM732	SGM735	SGM738	SGM741	SGM753	SGM756	-	-

Material	14" x 10"	6"	12"
Vinyl	15.15	10.10	17.65
Plastic	16.45	11.00	17.45
Alum.	39.95	-	-

# SIGNS

## FIRST AID



<b>Material</b>	14" x 10"	14" x 10"	14" x 10"	14" x 10"	14" x 10"	14" x 10"	14" x 10"	14" x 10"	6"	12"	6"	12"	6"	12"
Vinyl	SGM757	SGM760	SGM763	SGM766	SGM775	SGM778	SGM781	SGM783	SGN075	SGN078	SGN087	SGN090	SGN099	SGN102
Plastic	SGM758	SGM761	SGM764	SGM767	SGM776	SGM779	SGM782	SGM783	SGN076	SGN079	SGN088	SGN091	SGN100	SGN103
Alum.	SGM759	SGM762	SGM765	SGM768	SGM777	SGM780	SGM783	-	-	-	-	-	-	-

## ELECTRICAL



<b>Material</b>	14" x 10"	14" x 10"	14" x 10"	6"	12"
Vinyl	SGM742	SGM745	SGM748	SGM892	SGM895
Plastic	SGM743	SGM746	SGM749	SGM893	SGM896
Alum.	SGM744	SGM747	SGM750	-	-

## CONSTRUCTION



<b>Material</b>	6"	12"
Vinyl	SGN051	SGN054
Plastic	SGN052	SGN055
Alum.	-	-

## EQUIPMENT



<b>Material</b>	6"	12"
Vinyl	SGN147	SGN150
Plastic	SGN148	SGN151
Alum.	-	-

## HOUSEKEEPING & HYGIENE



<b>Material</b>	14" x 10"	14" x 10"	6"	12"	6"	12"	6"	12"	6"	12"	6"	12"	6"	12"
Vinyl	SGM784	SGM787	SGM880	SGM883	SGN069	SGN072	SGN105	SGN108	SGN129	SGN132	SGN135	SGN138	SGN153	SGN156
Plastic	SGM785	SGM788	SGM881	SGM884	SGN070	SGN073	SGN106	SGN109	SGN130	SGN133	SGN136	SGN139	SGN154	SGN157
Alum.	SGM786	-	-	-	-	-	-	-	-	-	-	-	-	-

## INDUSTRIAL TRAFFIC



<b>Material</b>	6"	12"	6"	12"	6"	12"	6"	12"	6"	12"
Vinyl	SGM796	SGM799	SGM814	SGM817	SGN045	SGN048	SGN063	SGN066	SGN081	SGN084
Plastic	SGM797	SGM800	SGM815	SGM818	SGN046	SGN049	SGN064	SGN067	SGN082	SGN085
Alum.	-	-	-	-	-	-	-	-	-	-

## SPECIFIC HAZARDS



<b>Material</b>	6"	12"	6"	12"
Vinyl	SGN039	SGN042	SGN057	SGN060
Plastic	SGN040	SGN043	SGN058	SGN061
Alum.	-	-	-	-

## FIRE & EMERGENCY



<b>Material</b>	6"	12"	14" x 10"	14" x 10"	6"	12"	6"	12"	6"	12"
Vinyl	SGN123	SGN126	SGM769	SGM772	SGN033	SGN036	SGN093	SGN096	SGN117	SGN120
Plastic	SGN124	SGN127	SGM770	SGM773	SGN034	SGN037	SGN094	SGN097	SGN118	SGN121
Alum.	-	-	SGM771	SGM774	-	-	-	-	-	-

<b>Material</b>	14" x 10"	6"	12"
Vinyl	15.15	10.10	17.65
Plastic	16.45	11.00	17.45
Alum.	39.95	-	-





## PROJECTION™ SIGNS

- 0.10" thick high-impact plastic
- 3D signs, projecting 45° from the wall, provide optimum viewing from front and sides
- 90D signs, projecting 90° from the wall, are viewed from either side
- Can be mounted with tapes and screws, not included

### 3D PROJECTION



### 90° PROJECTION



## ENGLISH



3D SAW419      90° SAW420



3D SAW431      90° SAW432



3D SAW437      90° SAW438



3D SAW439      90° SAW440



3D SAW443      90° SAW444



3D SAW445      90° SAW446



3D SAW449      90° SAW450



3D SAW453      90° SAW454



3D SAW463      90° SAW464

## FRENCH



3D SED960      90° SED961



3D SED962      90° SED963



3D SED964      90° SED965



3D SED966      90° SED967



3D SED968      90° SED969



3D SED970      90° SED971



3D SED972      90° SED973



3D SEE292      90° SEE293



3D SEE294      90° SEE295

**ACCUFORMNMC™**  
Justrite Safety Group

	Panel Size	Overall Size	Price /Each
3D	6" x 5"	6" x 8 1/2" x 4"	32.50
90°	8" x 8"	8" x 8" x 1 1/2"	34.50

## 90° PROJECTING SIGNS

- Projects 90° from the wall, providing excellent visibility from both sides
- Mount with tapes and screws (sold separately)
- Durable high-impact plastic
- Material: Plastic
- Height: 8"
- Width: 8"
- Display Type: Bolt-On
- Overall Depth: 1-1/2"



**ZENITH®**  
Safety Products

Model No.	Legend	Price /Each	Model No.	Legend	Price /Each	Model No.	Legend	Price /Each
SHG578	Fire Extinguisher	23.95	SHG577	Eye Wash	23.95	SHG580	First Aid	23.95
SHG576	Extincteur d'incendie	23.95	SHG579	Bassin oculaire	23.95	SHG577	Premiers Soins	23.95
SHG583	Boyaux d'Incendie	23.95	SHG582	Circulation chariots élévateurs	23.95	SHG584	DAE	23.95

IF YOU DO NOT SEE THE LEGEND OR SIZE YOU ARE LOOKING FOR PLEASE CALL US!



Post traffic signs to safely direct and regulate the flow of vehicles and pedestrians in and around parking areas, dock areas, and roadways. Keep driveways, throughways, and curbs free of vehicles and direct to designated parking locations with proper signs.

- Heavy-duty, 0.080" aluminum signs will not rust
- Reflective sign face provides added visibility in low-light conditions
- UV-resistant inks prevent fading during long-term outdoor use
- Supplied with top and bottom centre holes for post- or fence-mounting

### MATERIAL

**High Intensity (HP)** – High intensity prismatic sheeting is over three times brighter than standard engineer-grade sheeting.

**Aluminum (AL)**: Lightweight 0.032" aluminum with enamel non-reflective finish

## TRAFFIC REGULATORY SIGNS



<b>Mat'l</b>	30" x 30"	36" x 36"
<b>HP</b>	SAX448	SAX449
<b>Price/Each</b>	\$385.00	\$489.00



24" x 24"
SAX451
\$285.00



24" x 24"
SEC345
\$115.00



24" x 24"
SEC331
\$115.00



24" x 24"
SEA940
\$115.00



km/h	30" x 24"
10	HP
15	SAX463
20	SAX464
25	SAX465
30	SAX466
<b>Price/Each</b>	SAX467
	\$375.00

Other speeds also available. Contact us for details.



<b>Mat'l</b>	12" x 36"
<b>AL</b>	SAX478
<b>Price/Each</b>	\$195.00



<b>Mat'l</b>	12" x 36"
<b>HP</b>	SEJ246
<b>Price/Each</b>	\$239.00



<b>Mat'l</b>	12" x 36"
<b>HP</b>	SEJ247
<b>Price/Each</b>	\$239.00



<b>Mat'l</b>	24" x 24"	30" x 30"
<b>HP</b>	SEJ254	SEJ255
<b>Price/Each</b>	\$315.00	\$425.00



24" x 24"
SAX546
\$315.00



30" x 30"
SAX558
\$429.00



24" x 6"	36" x 12"
SAX573	SAX574
\$109.00	\$239.00



24" x 6"	36" x 12"
SAX577	SAX578
\$105.00	\$239.00



<b>Mat'l</b>	24" x 24"
<b>HP</b>	SEA975
<b>Price/Each</b>	\$109.00



24" x 24"
SEA977
\$115.00



24" x 24"
SEA973
\$109.00



24" x 24"
SEA998
\$109.00



24" x 24"
SEA956
\$115.00

## PARKING SIGNS

Reflective aluminum with UV lamination – Engineer Grade Reflective laminated over our aluminum sign blanks with mounting holes centered top and bottom.



Size	Price /Each
12" x 12" (30 cm x 30 cm)	84.90
12" x 18" (30 cm x 45 cm)	79.95
18" x 24" (45 cm x 60 cm)	195.00

## SIGN POSTS & HARDWARE

- Available in three sizes\*: 8', 10' and 12' posts
- Hardware set (sold separately) contains one nut, one bolt, one washer, and one spacer; two sets per installation are required
- Galvanized
- SAO201: Screw Diameter: 3/8" Screw Length: 2"



\*Other lengths also available. Contact us for details.



Model No.	Description	Length'	Price/Each
SAO195	Post	8	93.70
SAO196	Post	10	112.00
SAO197	Post	12	136.00
SAO201	Hardware Set	-	11.90
SAO725	Stake Base	4	57.40

## WRITE-A-DAY SCOREBOARDS

- Easily update safe working days with dry-erase marker
- Wipe-off and write-in on poly-coated space
- Constructed of durable plastic for indoor locations
- Has corner mounting holes

Size	Price/Each
20" x 14"	105.00
28" x 20"	145.00

### ACCESSORIES

Model No.	Description	Price/Each
OTK147	Chisel Tip Dry Erase Marker, Black	2.29



Justrite Safety Group



English  
20" x 14" SAV221  
28" x 20" SAV222



French  
20" x 14" SEE334  
28" x 20" SEE335



English  
20" x 14" SAV223  
28" x 20" SAV224  
French  
SEL064 SEL065



English  
20" x 14" SAV219  
28" x 20" SAV220  
French  
SEL066 SEL067



English  
20" x 14" SEJ377  
28" x 20" SEJ378  
French  
SEL068 SEL069



English  
20" x 14" SEJ379  
28" x 20" SEJ380  
French  
SEL070 SEL071





## THE GLOBALLY HARMONIZED SYSTEM (GHS)

The Globally Harmonized System of Classification and Labeling of Chemicals (GHS) is an international system established by the United Nations to replace pre-existing classification and labeling methods. GHS presents a unified code to eliminate discrepancies in labeling conventions from one country to another. Using a harmonized standard reduces the chance of misinterpretation or confusion, thereby increasing safety regardless of the language spoken or even the level of literacy of those working with the substances.

It covers the following:

- Classification of physical health and environmental hazards
- Labeling environments
- Universal symbols and pictograms
- Hazard warning statements, aspiration hazards
- Signal word for type of hazard
- Safety data sheet format

The risk of chemical exposure lurks at any stage; be it production, transport, handling or use. Incomplete or ambiguous data can be not only dangerous but have a negative impact on productivity. As such, GHS is designed to protect the environment as well as workers, consumers, transport workers, and emergency responders.

One of the other aims of GHS is to improve and expand international knowledge of the chronic health hazards of chemicals and thereby reduce, eliminate and/or replace these chemicals. Due to the complex nature of this domain, the GHS is constantly being modified and revised. Effective date is proposed to be two years after publication of final rule passage by Congress. For this reason, it's important to contact one of our experts to stay abreast of the latest GHS developments and how they affect you.



## CUSTOM GHS LABELS

CREATE YOUR OWN LABELS TO CONVEY HAZARD CLASS INFORMATION.

### How to Order:

1. Specify label size and material by part number
2. Send us your chemical or material information  
Refer to "Required Label Elements" guide
3. Provide guidance on label design if different from examples
4. Contact us with your request; we'll send you a proof (upon request)

### MATERIAL CHOICES

**Adhesive-poly sheet** - Flexible 2.6-mil thick vinyl has self-adhesive back. Peel-off liner and pressure-sensitive back permanently adheres to smooth, curved and irregular surfaces. Moisture resistant with outdoor durability

**Adhesive coated paper** - Economical, self-adhesive label is durable for limited use. 60-lb. coated paper with acrylic adhesive back. Peel off liner and permanently adhere to smooth, curved and irregular surfaces.  
Sizes available in 3" x 4", 4" x 6", 6" x 8", 9" x 12", 10" x 14".

\*9" x 12" and 10" x 14" (or larger) labels are recommended when DOT label pictogram is included to maintain the required 4" x 4" (100 mm x 100 mm) size.

ACETONE

**DANGER**  
Highly flammable liquid and vapor.  
Causes severe eye irritation.

Keep away from heat, sparks, static discharge. Keep container closed when not in use. Use only in a well-ventilated place. Wear appropriate personal protective equipment. Flush eyes with water for at least 15 minutes while holding eyelids open.

Company Name: \_\_\_\_\_  
Address: \_\_\_\_\_  
City: \_\_\_\_\_ Sta \_\_\_\_\_

CAS Number: 67-64-1  
Category 2 Flammable Liquid and  
Category 2A Eye Damage/Irritation

Format 1

---

ACETONE

**Danger**  
Highly flammable liquid and vapor.  
Causes severe eye irritation.

1234 First Avenue  
Any Town, Any State 12345  
Phone Number: 123-456-7891

CAS Number: 67-64-1  
ACETONE

Format 2

Fill weight: 10 lbs.  
Gross weight: 21 lbs.  
Expiration: 5/13/14  
Lot Number: 012456  
Fill Date: 8/14/12

Keep away from heat, sparks and flame – No smoking. Take precautionary measures against static discharge. Keep from direct sunlight. Keep container closed when not in use. Store in a cool/low temperature, well-ventilation place away from heat and ignition sources. Use only in a well ventilated area. Avoid contact with eyes, skin and clothing. Wear appropriate personal protective equipment, avoid direct contact. Flush eye with water for at least 15 minutes while holding eyelids open.

Actual label design and layout may vary and are subject to the discretion of the competent authority.

### REQUIRED LABEL ELEMENTS

1. **Product Identifier** – Should match the product identifier used on the Safety Data Sheets.
2. **Signal Word** – Indicates the relative level of the hazard's severity. "Danger" and "Warning" are the GHS signal words.
3. **Pictograms** – Graphic compositions intended to convey specific hazard information.
4. **Hazard Statements** – A phrase assigned to a hazard class and category that describes the nature of the product hazards.
5. **Precautionary Statements** – Describe recommended measures to minimize or prevent adverse effects resulting from exposure.
6. **Supplier Identification** – The name, address and telephone number of the manufacturer or supplier.

**Note:** You are required to provide all necessary information specific to your hazardous chemical or material, to complete an accurate and safe label for your premises.

568

SAFETY EQUIPMENT  
& SUPPLIES

## SAFETY DATA SHEET INFORMATION STATIONS

- Provides a central place to easily access all the new regulation SDS sheets for your plant or office
- Sturdy metal pocket design to hold the included binder
- The mounting board is constructed of 1/4" rigid plastic with four mounting holes to provide easy mounting and years of durability
- Stations include either one (Single) or two (Double) standard 3-ring SDS binders with A - Z alphabetical dividers to sort all of your Safety Data Sheets
- Available in two sizes in English or English/French



SEJ590



SEJ593

### INCOM

Model No.	Mfg. No.	Size"	Description	Price/Each
SEJ590	GHS1012	Single Station, 18 x 24	English	265.00
SEJ591	GHS1011	Double Station, 24 x 36	English	455.00
SGT125	GHS1085	Single Station, 17.5 x 15.5	English/French	195.00
SEJ592	GHS1021	Single Station, 18 x 24	English/French	265.00
SEJ593	GHS1020	Double Station, 24 x 36	English/French	449.00

## SAFETY DATA SHEET BINDERS

- Organize and access Safety Data Sheets quickly and easily with SDS binders
- Binders come in two sizes; 1 1/2" and 3"
- The regular size binders come with a standard 1 1/2" D-slant format ring
- The large binder comes with a 3" D-slant ring for easy storage of large numbers of SDS sheets
- All our binders come with sturdy A-Z alphabetical reinforced dividers to sort and organize your Safety Data Sheets
- Printed with bright graphics on a white background, these binders will be highly visible in the workplace



SEJ594



SDP091

### INCOM

Model No.	Mfg No.	Size"	Description	Price/Each
SEJ594	GHS1008	1 1/2	English	42.90
SEJ595	GHS1049	3	English	64.90
SEJ596	GHS1009	1 1/2	English/French	41.50
SDP091	GHS1082	3	English/French	62.90

## GHS INFORMATION STATIONS

- Provides a central location to easily access all newly regulated SDS sheets as well as the basic information required for the GHS system for WHMIS
- The board is printed with the 3 main hazard groups; Physical, Health & Environmental
- Provides requirements for supplier labels when decanting or transferring hazardous chemicals
- Visual representations of the precautionary statement pictograms
- Lists the information required on a Safety Data Sheet
- Printed in full colour on a mounting board and comes with a sturdy metal pocket
- Stations include either one (Single) or two (Double) standard 3-ring SDS binders with A - Z alphabetical dividers to sort all of your Safety Data Sheets
- The mounting board is constructed of 1/4" rigid plastic with 4 mounting holes to provide easy mounting and years of durability
- Available in two sizes in English or English/French



SEJ587



SEJ586

### INCOM

Model No.	Mfg No.	Size"	Description	Price/Each
SEJ586	GHS1002C	Single Station, 18 x 24	English	309.00
SEJ587	GHS1001C	Double Station, 24 x 36	English	495.00
SEJ588	GHS1072	Single Station, 18 x 24	English/French	279.00
SEJ589	GHS1019	Double Station, 24 x 36	English/French	495.00



### CANADIAN 5 LEGEND FLIP CHART PLACARDS

- With 5 Canadian T.D.G. legends at your disposal, you can use this flip chart for almost any load
- Exclusive design is built for durability, heavy 0.031" white aluminum back plate for wind protection
- Baked-on polyester finish to resist fading
- Pages are made from a durable powder coated aluminum for longevity



LEGENDS



Model No.	Mfg. No.	Description	Price /Each
SAK381	FC5010WH	5-Legend Flip Chart	149.00

### FUEL FLIP CHART PLACARDS

- These popular units are enamel and comply with the new "Clear Language" Transport Canada Regulations for bulk shipments for these products
- Both pages are Class 3 Flammable Liquid
- One page has the UN number 1202, and the other page has the UN number 1203
- Units are constructed of all aluminum and stainless steel parts for added longevity



LEGENDS



Model No.	Mfg. No.	Material	Price /Each
SAG845	FC4020AL	Aluminum Base	74.50
SD357	FC4020WH	White Base	77.50

### CANADIAN 14 LEGEND FLIP CHART PLACARDS

- Be ready for any shipment with 13 Canadian T.D.G. legends plus a blank white page
- Exclusive design is built for durability, heavy 0.031" aluminum back plate for wind protection
- Baked-on polyester finish to resist fading
- Pages are made from a durable powder coated aluminum for longevity



LEGENDS

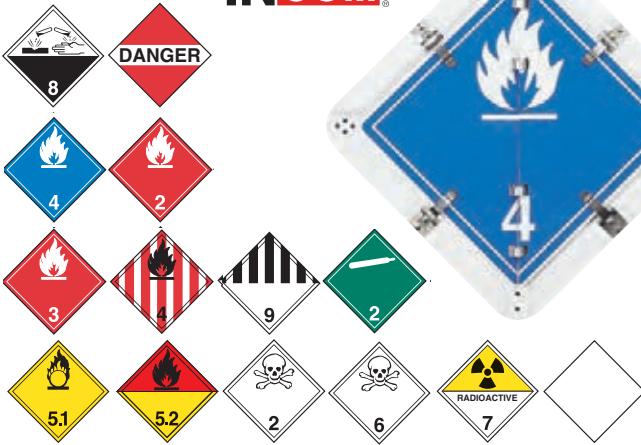

Model No.	Mfg. No.	Description	Price /Each
SAK382	FC5000WHR	14-Legend Flip Chart	249.00

### PLACARD HOLDERS

- Manufactured of natural aluminum with stainless steel clips for years of service
- Holders come with 10 pre-drilled mounting holes for easy application
- The back plate has several dimples to ease the placards out of the holder and up and over the clip assembly

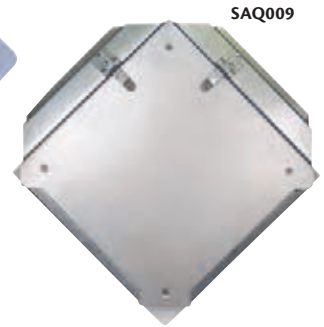
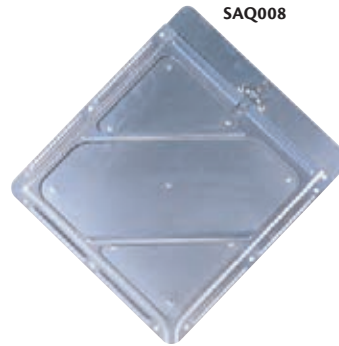

Model No.	Mfg. No.	Description	Price /Each
SAQ008	PH223	Placard holder	24.50
SAQ009	PH227	Easy Access Design	53.50

### SIGNS



Material	Price /Each	Model No.	Mfg. No.	Model No.	Mfg. No.	Model No.	Mfg. No.	Model No.	Mfg. No.
Adhesive Vinyl - 18" x 18"	67.50	SEI459 - PS	LVHR904XVE	SEI461 - PS	FRLVHR904XVE	SEI463 - PS	LVHR907XVE	SEI465 - PS	FRLVHR907XVE
Aluminum - 18" x 18"	129.00	-	-	SEI462 - AL	FRMVT620VA	-	-	SEI466 - AL	FRMVTRO01VA



CLASS 1



Material	A. Explosive 1.1A		B. Explosive 1.1D		C. Explosive 1.4G		D. Explosive 1.5D	
	Model No.	Mfg. No.	Model No.	Mfg. No.	Model No.	Mfg. No.	Model No.	Mfg. No.
Rigid Plastic	SJ334	TT110ASS	SAH452	TT110DSS	SJ347	TT140GSS	SJ350	TT150DSS
Tagboard	SJ335	TT110ATB	SAH453	TT110DTB	SJ348	TT140GTB	SJ351	TT150DTB
Adhesive Vinyl	SD299	TT110ATB	SAH454	TT110DPS	SD301	TT140GPS	SD303	TT150DPS
Aluminum	SD300	TT110AAL	SAH455	TT110DAL	SD302	TT140GAL	SD304	TT150DAL

CLASS 2



Material	E. Flammable Gas		F. Compressed Gas		G. Poison Gas		H. Oxidizer	
	Model No.	Mfg. No.	Model No.	Mfg. No.	Model No.	Mfg. No.	Model No.	Mfg. No.
Rigid Plastic	SJ356	TT210SS	SJ358	TT220SS	SJ360	TT230SS	SJ364	TT232SS
Tagboard	SJ357	TT210TB	SJ359	TT220TB	SJ361	TT230TB	SJ365	TT232TB
Adhesive Vinyl	SD307	TT210PS	SD311	TT220PS	SD315	TT230PS	SD309	TT232PS
Aluminum	SD308	TT210AL	SD312	TT220AL	SD316	TT230AL	SD310	TT232AL

CLASS 3



Material	I. Flammable Liquids	
	Model No.	Mfg. No.
Rigid Plastic	SJ368	TT300SS
Tagboard	SJ369	TT300TB
Adhesive Vinyl	SD319	TT300PS
Aluminum	SD320	TT300AL

CLASS 4



Material	J. Flammable Solid		K. Spontaneously Comb.		L. Dangerous When Wet	
	Model No.	Mfg. No.	Model No.	Mfg. No.	Model No.	Mfg. No.
Rigid Plastic (SS)	SJ370	TT410SS	SJ372	TT420SS	SJ374	TT430SS
Tagboard (TB)	SJ371	TT410TB	SJ373	TT420TB	SJ375	TT430TB
Adhesive Vinyl (PS)	SD321	TT410PS	SD323	TT420PS	SD325	TT430PS
Aluminum (AL)	SD322	TT410AL	SD324	TT420AL	SD326	TT430AL

PLACARD PRICING

Material	Price /Each
Rigid Plastic (SS)	2.59
Tagboard (TB)	0.88
Adhesive Vinyl (PS)	2.09
Aluminum (AL)	38.90

## CLASS 5



## CLASS 6



**INCOM**

Material	M. Oxidizers		N. Organic Peroxides		O. Poison, Poisonous Sub.		P. Infectious Substances	
	Model No.	Mfg. No.	Model No.	Mfg. No.	Model No.	Mfg. No.	Model No.	Mfg. No.
Rigid Plastic	SJ376	TT510SS	SEC884	TT521SS	SJ380	TT600SS	SAG840	TT620SS
Tagboard	SJ377	TT510TB	SEC885	TT521TB	SJ381	TT600TB	SAG841	TT620TB
Adhesive Vinyl	SD327	TT510PS	SEC886	TT521PS	SD331	TT600PS	SAG842	TT620PS
Aluminum	SD328	TT510AL	SEC887	TT521AL	SD332	TT600AL	SAG843	TT620AL

## CLASS 7



## CLASS 8



## CLASS 9



**INCOM**

Material	Q. Radioactive Material		R. Corrosive		S. Misc Dangerous Goods	
	Model No.	Mfg. No.	Model No.	Mfg. No.	Model No.	Mfg. No.
Rigid Plastic	SJ384	TT700SS	SJ386	TT800SS	SJ419	TT960SS
Tagboard	SJ385	TT700TB	SJ387	TT800TB	SJ420	TT960TB
Adhesive Vinyl	SD335	TT700PS	SD337	TT800PS	SD339	TT960TB
Aluminum	SD336	TT700AL	SD338	TT800AL	SD340	TT960AL

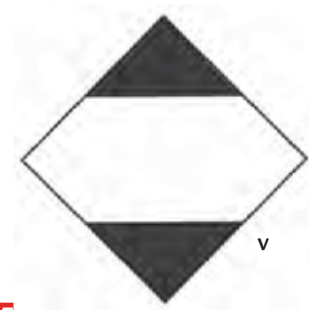

**INCOM**

Material	T. Danger, Mixed Loads		U. Environmental Pollutant		V. Limited Quantity	
	Model No.	Mfg. No.	Model No.	Mfg. No.	Model No.	Mfg. No.
Rigid Plastic	SJ390	TT950SS	SEI890	TT166SS	SEI894	TT980SS
Tagboard	SJ391	TT950TB	SEI891	TT166TB	SEI895	TT980TB
Adhesive Vinyl	SD345	TT950PS	SEI892	TT166PS	SEI896	TT980PS
Aluminum	SD346	TT950AL	SEI893	TT166AL	SEI897	TT980AL

## PLACARD PRICING

Material	Price /Each
Rigid Plastic (SS)	2.59
Tagboard (TB)	0.88
Adhesive Vinyl (PS)	2.09
Aluminum (AL)	38.90

## SAFETYWHIPS USA - FIELD PROVEN, HIGH VISIBILITY PRODUCTS

### LIGHT-DUTY, HEAVY-DUTY AND SUPER-DUTY WARNING WHIPS

- Multiple pole, whip light and mount option
- Temporary or permanent mounting
- Internationally proven technology and quality
- Be seen, stay safe!

#### SAFETY WHIPS

- 11.5" x 11.5" mesh flag



Model No.	Length'	Base	Flag	Price /Each
<b>LIGHT-DUTY</b>				
SDP028	5	Magnet	Orange	135.00
SDP029	5	Magnet	Orange w/Reflective X	159.00
SDP031	5	Window Mount	Orange w/Reflective X	237.00

<b>HEAVY-DUTY - NON-POWERED</b>				
SDN979	5	Threaded	Orange	82.40
SDN990	5	Threaded	Orange w/Reflective X	106.00
SDN981	8	Threaded	Orange	101.00
SDN980	8	Threaded	Orange w/Reflective X	124.00
SDN982	10	Threaded	Orange	114.00
SDN991	10	Threaded	Orange w/Reflective X	137.00

<b>HEAVY-DUTY - POWERED</b>				
SDN998	5	Threaded	Orange	158.00
SDN995	5	Threaded	Orange w/Reflective X	165.00
SDN993	8	Threaded	Orange	190.00
SDN996	8	Threaded	Orange w/Reflective X	201.00
SDN997	10	Threaded	Orange	217.00
SDN985	10	Threaded	Orange w/Reflective X	241.00

#### LIGHTING OPTIONS FOR HEAVY-DUTY SAFETY WHIP - POWERED

Model No.	Description	Colour	Price /Each
SGR211	High Impact - Sealed, Non-Flash LED	Blue	78.80
SGR212	High Impact - Sealed, Non-Flash LED	Green	78.80
SGR213	High Impact - Sealed, Non-Flash LED	Amber	78.80
SGR215	High Impact - Sealed, Non-Flash LED	Amber / Red	78.80
SGY861	High Impact - Sealed, Flashing LED	White	78.80
SGY862	High Impact - Sealed, Non-Flash LED	Red	78.80

#### ACCESSORIES FOR HEAVY-DUTY SAFETY WHIP

Model No.	Mfg. No.	Description	Price /Each
<b>FOR NON-POWERED WHIPS</b>			
SDP006	519.30BNP	Heavy-Duty Spring Mount	79.10
SDP583	ABM	Angle Bracket Mount	56.40
SDP582	HM1NP	Hitch Mount	186.00

<b>FOR POWERED WHIPS</b>			
SDN978	519.30B	Heavy-Duty Spring Mount	106.00
SDP027	ABM/RCA	Angle Bracket Mount	87.30
SDP584	SPM	Stake Pocket Mount	276.00
SDN988	HM1	Hitch Mount	245.00
SDP012	519.33LHR	Magnet Mount, Handle & Cigarette Cord	285.00

#### SUPER-DUTY PERMANENT MOUNT SAFETY WHIPS

- Complete whip assembly: Orange 16" x 16" flag with reflective X, heavy-duty spring and low profile - sealed, non flash LED

Model No.	Description	Colour	Price /Each
SGY855	3' Complete Safety Whip Assembly w/ Amber LED	Amber	439.00
SGY856	5' Complete Safety Whip Assembly w/ Amber LED	Amber	460.00
SGY857	8' Complete Safety Whip Assembly w/ White LED	White	460.00





## QUADRAFLEX ROLL-UP SIGNS

- Temporary traffic control signs for construction, work zones and emergency traffic control
- Meets NCHRP-350 Certification and MUTCD standards
- Designed with technology to increase sign detection, especially in low-light conditions
- Designed with micro-prismatic reflective sheeting bonded to a heavy-duty fibre-reinforced vinyl material
- Will not delaminate and provides outstanding durability, legibility and long sign life
- Signs will not wrinkle or crinkle and will maintain its legibility after multiple uses
- Easy to transport



Circle Cortina Industries Canada Limited

Model No.	Mfg. No.	Legend	Price /Each
<b>60 CM (23 3/5") X 75 CM (29 1/2")</b>			
SDP373	07-800-35102	Ligne D'Arrêt w/Arrow	164.00
<b>75 CM (29 1/2") X 75 (29 1/2")</b>			
SDP367	07-800-0123	Men at Work Pictogram	164.00
SDP368	07-800-0124	Arrow	164.00
SDP369	07-800-0135	Merge Left Pictogram	164.00
SDP370	07-800-0136	Yield Ahead Pictogram	162.00
SDP372	07-800-35101	Do Not Pass Pictogram	164.00
SDP374	07-800-35103	Stop Light Pictogram	164.00
SDP375	07-800-35104	Man In Bucket Pictogram	164.00
SDP376	07-800-35105	Flagman Pictogram	164.00
SDP377	07-800-35106	Lentement	164.00
SDP566	07-800-0137	Merge Right Pictogram	164.00
<b>90 CM (36") X 90 CM (36")</b>			
SDP359	07-800-3026-L	Men at Work Pictogram	190.00
SDP360	07-800-3028-L	Construction w/Upwards Arrow	190.00
SDP361	07-800-3044-L	Merge Right Pictogram	190.00
SDP362	07-800-3045-L	Merge Left Pictogram	190.00
SDP363	07-800-3051-L	Flagman Pictogram	190.00
SDP366	07-800-3060-L	Arrow	190.00
SDP378	07-800-3058-L	Yield Ahead Pictogram	267.00
SDP371	07-800-30104	Emergency Scene Ahead	190.00
<b>90 CM (36") X 120 CM (48")</b>			
SDP364	07-800-3056-L	Yield Pictogram to Oncoming Traffic	288.00
SDP365	07-800-3057-L	Road Closed Pictogram	288.00

### QUADRAFLEX ROLL-UP SIGN STANDS

Model No.	Mfg. No.	Description	Price /Each
SDP357	07-804-1	W/Roll-Up Bracket	374.00



23-3/5" x 29-1/2"  
SDP373



36" x 48"  
SDP364



36" x 48"  
SDP365

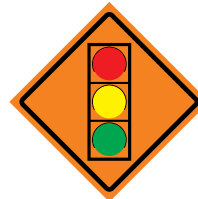

29-1/2" x 29-1/2"  
SDP374



29-1/2" x 29-1/2"  
SDP375



29-1/2" x 29-1/2"  
SDP372



29-1/2" x 29-1/2"  
SDP369



36" X 36"  
SDP362



29-1/2" x 29-1/2"  
SDP566

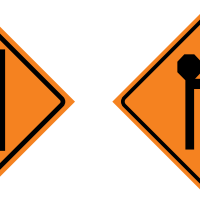

36" X 36"  
SDP361



29-1/2" x 29-1/2"  
SDP376



36" X 36"  
SDP363



29-1/2" x 29-1/2"  
SDP367



36" X 36"  
SDP359



29-1/2" x 29-1/2"  
SDP370

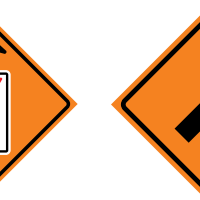

36" X 36"  
SDP378



29-1/2" x 29-1/2"  
SDP368



36" X 36"  
SDP366



29-1/2" x 29-1/2"  
SDP377



36" X 36"  
SDP360



36" X 36"  
SDP371

## TRAFFIC SAFETY FLAGS

- For use as hand or vehicle flags
- Comes with 24" or 36" wooden staff
- Use 36" wooden staff model with moving vehicles
- Flag size: 18" x 18"
- Available in mesh, vinyl or throw away vinyl
- Mesh flag: Heavy-duty fluorescent with plastic trim; resists tearing, fraying or snagging
- Vinyl flag: Fluorescent vinyl blend with heat-sealed hem
- Throw away vinyl flag sold as a case of 100
- Colour: Red/Orange



Model No.	Mfg. No.	Description	Wooden Staff"	Price /Each
<b>FLAG WITH STAFF</b>				
SC140	03-229-3406	Mesh Flag	24	9.59
SC141	03-229-3463	Mesh Flag	36	9.70
SAP711	03-229-3417	Vinyl Flag	24	7.14
SC143	03-229-3405	Vinyl Flag	36	8.95
<b>FLAG ONLY</b>				
SGG310	-	Mesh Flag	-	3.95
SGG314	-	Polyester Flag	-	4.95

## SAFETY BATON LIGHT

- High visibility LED light source to safely direct traffic
- Durable weather resistant design with carrying strap
- Two light modes include Steady On and Flashing
- Requires (2) D batteries
- Light Colour: Orange
- Length: 21"



Model No.	Description	Price /Each
SGW959	Safety Baton Light	13.50

## MEGAPHONES

- Up to one mile carry sound range
- Features pistol grip and trigger for 1-hand operation
- Requires 8 "C" batteries
- Includes piercing siren sound for emergency situations
- 15 W RMS power output
- Power Output: 25-w Peak
- Range: 1 miles
- Weight: w/o batteries 2.7 lbs., w/batteries 3.9 lbs.



Model No.	Length"	Height"	Price /Each
SEE894	15	9	125.00

## MUNICIPAL TRAFFIC SIGNS

- Octagon shaped paddle sign
- Sign is plastic with engineer grade reflective material
- Ideal for school crossing guards and low speed construction areas
- 18" sign and 9" plastic polygrip handle included
- Meets MUTCD regulations



Model No.	Mfg No.	Description	Price /Each
SEI474	03-855	STOP/STOP Sign w/handle	72.50
SEI475	03-852	STOP/SLOW Sign w/handle	62.90
SFU868	03-890-AA	ARRÊT/ARRÊT	72.50
SFU869	03-891-AL	ARRÊT/LENTÉMENT	61.80

## TRAFFIC CONTROL SIGNS

- High-intensity, double-sided hand-held traffic sign
- Directs traffic by signaling the desired warning towards oncoming vehicles
- STOP legend red with white legend and border
- SEJ663: SLOW legend orange with black legend and border
- SO101: SLOW legend fluorescent yellow/green with black legend and border
- Size: 18" x 18"
- 9" EZ grip handle included



Model No.	Mfg No.	Description	Price /Each
SEJ663*	03-836	STOP/SLOW Sign – MUTCD regulated	111.00
SFU870	03-836-FR	ARRÊT/LENTÉMENT Sign – MUTCD regulated	111.00
SO101	03-8580N	STOP/SLOW Sign – MTO TC-22 regulated	111.00

\* For all provinces except ON & QC

## SLOW MOVING VEHICLE SIGNS

Available in two styles. Heavy duty, aluminum backed triangle mounts easily using screwholes provided. Self-adhesive decal triangle mounts quickly to any smooth, clean surface. Meets all provincial and federal specifications.



Model No.	Mfg. No.	Description	Price /Each
SC153	05-099-10	Aluminum Sign	34.10
SC154	TTR006-AC	Self-Adhesive Sign	53.50

## PARKING CURBS

- 1-piece lightweight 100% recycled rubber
- Resistant to corrosion, moisture, oil, weather variations and UV light
- Safer and more durable than concrete or plastic; will not chip, crack or deform
- Black with bright yellow reflective stripes for maximum visibility
- Easily installed with 14" rebar spikes for permanent or temporary installation
- 6" W x 4" H



Model No.	Length	Spikes Required	Weight lbs.	Price /Each
<b>PARKING CURB</b>				
SEH140	3'	3	20	49.95
SEH141	6'	4	35	99.95
<b>REBAR SPIKE</b>				
SEH144	14"	-	-	4.95



## TRIANGULAR REFLECTOR KITS

- Ideal for increasing visibility around disabled vehicles
- Fast and easy to set up and stow away
- Weighted base provides additional stability
- Instructions for proper use are printed on the case and on each triangle
- Kit includes 3 Triangles and a red carry case
- Meets DOT FMVSS 125 standards



Model No.	Description	Price /Each
SGD773	Industrial Kit	43.95

## SPEED BUMPS

- 1-piece lightweight 100% recycled rubber
- Resistant to corrosion, moisture, oil, weather variations and UV light
- Perfect for speed reduction in parking lots, school zones and areas with heavy pedestrian traffic
- Black with bright yellow reflective stripes for maximum visibility
- Easily installed with 14" rebar spike for permanent or temporary installation
- 11" W x 2" H
- Capacity: approx. 18 tons at 10 km/h



Model No.	Description	Length	Spikes Required	Weight lbs.	Price /Each
SEH142	Speed Bump	4'	5	35	119.00
SEH143	Speed Bump	6'	4	55	170.00
SEH144	Rebar Spike	14"	-	-	4.95
SHA660	End Cap	-	1	-	24.95

## SAFETY FLARES

- Visible in fog, rain, or snow
- Easy to ignite with self-contained striker
- 20 or 30-minute duration
- Spike or wire stands available
- UL approved



Model No.	Mfg. No.	Description	Qty /Pkg.	Price /Each
<b>20 MINUTES</b>				
SAI373	2720	Spike	72	438.00
SAI374	9240	Wire stand	72	503.00
<b>30 MINUTES</b>				
SAI375	2730	Spike	36	272.00
SAI376	9340	Wire stand	36	415.00

## FLARE CONTAINERS

Model No.	Mfg. No.	Description	Price /Each
SDP618*	300	Holds up to four 20 minute flares	60.50
SDP619*	5300	Holds up to four 30 minute flares	53.80
SDP620	7830	Holds up to eighteen 30 minute flares	58.60

\* Wall Mounting bracket included

SDP618





## TRAFFIC CONE

- Fluorescent orange colour provides high visibility
- Interlocking cone and base
- Can withstand temperatures -10°C to 60°C
- Height: 28"
- Colour: Orange
- Reflective Collars: 4"
- Material: EVA Plastic with Rubber base
- Weight: 6.8 lbs.
- Base Dimensions: 14.17" W x 14.17" L
- Standard(s) Met: Ontario & Alberta Ministry of Transport Regulations

Model No. **SGU800**  
Price/Each **\$22.95**



## TRAFFIC CONE

- 1-piece lightweight PVC construction offers flexibility and durability
- Ideal for sporting events, driver's education courses and marking indoor hazards
- Height: 6"
- Base Dimensions: 5 7/8" W x 5 7/8" L
- Colour: Orange

Model No. **SCG920**  
Price/Each **\$5.45**



## TRAFFIC CONES

- 100% PVC construction offers excellent flexibility and durability
- Temperature resistance in hot and cold environments
- Fluorescent orange color provides high visibility
- Available with 6" and 4" reflective collars
- High-density interlocking base offers maximum stability
- Meets Minister of Transport regulations for Quebec, Ontario and Alberta

SEF026



## COLOURED CONES

- 1-piece lightweight PVC construction offers flexibility and durability
- Temperature resistance in hot and cold environments
- Ideal for parking lots, sporting events, festivals and crowd delineation
- Choice of six colour coding options



SEH136



SEH137



SEH139



Model No.	Height"	Base Dimensions			Collar	Wt. lbs.	Price /Each
		W"	x	L"			
SEF026	18	10 1/4	x	10 1/4	6" (QC, ON, AB)	3.15	17.30
SEF027	28	13 3/4	x	13 3/4	4" (ON, AB)	6.75	29.35
SEF028	28	13 3/4	x	13 3/4	6" and 4" (QC, ON, AB)	6.75	32.50

Model No.	Colour	Height"	Base Dimensions			Price /Each
			W"	x	L"	
SEK283	Red	18	10 1/4	x	10 1/4	14.65
SEH135	White	18	10 1/4	x	10 1/4	14.65
SEH136	Blue	18	10 1/4	x	10 1/4	14.65
SEH137	Yellow	18	10 1/4	x	10 1/4	14.65
SEH138	Orange	18	10 1/4	x	10 1/4	14.65
SEH139	Green	18	10 1/4	x	10 1/4	14.65
SDP595	Orange	28	14	x	14	23.50

## RECESSED CONES

- One-piece wide body design and construction
- Easier stacking - no pinch points with collars
- Increased durability for reflective sheeting; recessed collars resist direct wear
- Protected reflective translates into longer service life lowering overall usage costs
- 28" cone with 6" reflective collar on top and 4" reflective collar on bottom
- Weight: 7 lbs.
- Base width: 14"
- Meets MUTCD standards

Model No. **SAQ093**  
Mfg. No. 03-500-100R  
Price/Each **\$34.00**



## PREMIUM TRAFFIC CONES

- 100% PVC construction offers maximum flexibility and durability
- Superior temperature resistance in hot and cold environments
- Fluorescent orange color provides high visibility
- Available with 6" and 4" 3M™ high intensity collars
- High density interlocking base offers maximum stability



SEB768



SDS934

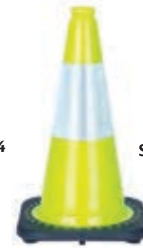

SEB772



## COLLAPSIBLE TRAFFIC CONE

- Made from a durable plastic base and a folding fabric cone
- Internal light flashes for better visibility
- Collapses for easy storage
- Uses a replaceable, long-lasting lithium-ion battery
- Meets MUTCD Standards
- Includes: (4) Cones, (1) Carrying case
- Colour: Orange
- Reflective Collars: 4"



Model No.	Overall Height"	Price /Each
SHA659	18	115.00
SHA820	28	145.00



Model No.	Description	Base Dimensions			Colour	Wt. lbs.	Price /Each
		W"	x	L"			
<b>TRAFFIC CONE</b>							
SEB768	12"	8 5/8	x	8 5/8	Orange	2	8.99
SEB769	18"	10 1/4	x	10 1/4	Orange	3.3	14.60
SEB771	28"	13 3/4	x	13 3/4	Orange	7	28.10
SDS932	18"	10 1/4	x	10 1/4	Lime Green	3.3	18.30
SDS933	28"	13 3/4	x	13 3/4	Lime Green	7	34.25
<b>TRAFFIC CONE W/COLLAR</b>							
SEB770	18" w/6" Collar**	10 1/4	x	10 1/4	Orange	3.3	21.60
SEB772	28" w/6" & 4" Collar**	13 3/4	x	13 3/4	Orange	7	38.70
SGD774	36" w/6" & 4" Collar**	14 3/4	x	14 3/4	Orange	10	49.95
SEB826	28" w/4" Collar*	13 3/4	x	13 3/4	Orange	7	31.15
SDS934	18" w/6" Collar**	10 1/4	x	10 1/4	Lime Green	3.3	26.50
SDS935	28" w/6" & 4" Collar**	13 3/4	x	13 3/4	Lime Green	7	43.25
SGD694	28" w/4" Collar*	13 3/4	x	13 3/4	Blue	7	35.15
SGC936	28" w/4" Collar*	13 3/4	x	13 3/4	Yellow	7	34.65

\* Meets Minister of Transport regulations for Ontario and Alberta

\*\* Meets Minister of Transport regulations for Quebec, Ontario and Alberta

# TRAFFIC SAFETY

## TRAFFIC CONE TOPPER

- 9.8' red and white striped belt
- Easier to use than traffic tape
- Fits securely to top of cone to transform traffic cones into a crowd control system
- Durable construction
- Cones not included
- Ideal for use anywhere where temporary crowd and traffic control is required

Model No. SGY103  
Price/Each \$39.95



## TRAFFIC CONE RACK HOLDER

- All steel metal construction
- Mount with the four corner holes onto a wall or side of work vehicle
- For Use With: 18" or 28" Cones



Justrite Safety Group

Model No.	Mfg. No.	Price /Each
SGU871	FBC105	78.50



## RETRACTABLE CONE BAR

- Designed for use with traffic cones and delineator posts
- Permits to easily and quickly setup a safety barrier
- Lightweight design permits ease of transport and setup
- Made of high quality ABS materials for best durability
- Fluorescent colour for enhanced daytime visibility
- Reflective tape offers maximum nighttime visibility and safety



Model No.	Collapsed Length	Extended Length	Colour	Price /Each
SDP614*	4' 5"	7' 5"	Black/Orange	40.10
SGS309	4'-1/4"	7'-1/4"	Black/Yellow	12.95

\*3M™ Reflective Tape

## PREMIUM DELINEATOR POSTS

- Standard 42" high post with indentations for easier grip
- 100% LDPE construction offers maximum flexibility and durability
- Superior temperature resistance in hot and cold environments
- Fluorescent orange colour provides high visibility
- Two pre-applied 4" 3M™ high intensity reflective tape collars
- High density interlocking 16" x 16" base offers maximum stability and durability
- Post includes convenient carrying handle
- Octagonal base includes carrying handle



SEC153

Model No.	Description	Post Handle Height"	Wt. lbs.	Price /Each
SEC153	Delineator Post w/Octagonal Base	5-1/2	14	40.50
SGG105	Delineator Post w/Rectangular Base	5-1/2	13	42.50
SEB773	Delineator Post Only	5-1/2	1.8	24.60
SGK247	Rubber Octagonal Base	-	12	24.95
SGG098	Rubber Rectangular Base	-	11	19.95



## HI-VISIBILITY T-TOP DELINEATOR POST

- Standard 42" high post with indentations for easier grip
- 100% LDPE construction offers maximum flexibility and durability
- Fluorescent orange colour provides high visibility
- Two pre-applied 4" high intensity reflective tape collars
- Perfect for parking lots, hotels and airports
- High density base offers maximum stability and durability
- Octagonal base includes convenient carrying handle



Model No.	Description	Wt. lbs.	Price /Each
SGJ238	Delineator Post Only	1.8	22.50
SGJ239	Delineator Post w/Octagonal Base	13.75	36.95
SGJ240	Delineator Post w/Rectangular Base	11.50	36.25
SGK247	Octagonal Base	12	24.95
SGG098	Square Base	11	19.95



## CHANNELIZER CONES

- 42" high channelizer cone is made of high impact orange polyethylene
- Comes with a 4" and 6" reflective collar for improved visibility
- Unique shaped handle makes it easy to transport
- Cone dimensions: 4" at top tapering to 8" at bottom
- Choice of 10-lb. square base or 16-lb. octagon shaped base sold separately



SC104



SEE893



Model No.	Mfg. No.	Description	Price /Each
SEI476	03-770-42-64	Channelizer Cone	38.30
SEE893	03-752-10	10-lb. Square Base	19.10
SC104	03-752-16	16-lb. Octagon Base	30.30

## EZ-GRAB™ CHANNELIZERS

- Constructed of HDPE with UV inhibitors
- Lower profile design uses less space
- EZ-Grab™ handle makes it easy to transport and store
- 4" hi-intensity stripes
- Meets NCHRP-350 crash test requirements and MUTCD standards
- 13" D at top x 16.5" D at bottom x 44.12" H
- Choice of 15-lb. or 20-lb. base, sold separately



SEI395



Model No.	Mfg. No.	Description	Provincial Specification	Wt. lbs.	Price /Each
<b>CHANNELIZER</b>					
SEI395	03-756-4HI0	Black/Orange	ON, NL	-	57.50
SEI396	03-755-4HI	Orange/White	BC, AB, SK, NS, PE, MB	-	70.30
<b>BASE</b>					
SAS372	03-732-WR	Base for SEI395, SEI396 and SAS373	-	15	15.00
SEC002	03-732	Base for SEI395, SEI396 and SAS373	-	20	40.50

## CHANNELIZERS

- Molded from linear low density polyethylene
- 2-piece channelizer drum is stackable
- Meets or exceeds M.T.O. TC-54 specifications
- Choice of 15-lb. or 20-lb. base, sold separately



SAS372



SEC002

SHJ267



Model No.	Mfg. No.	Description	Provincial Specification	Wt. lbs.	Price /Each
<b>CHANNELIZER</b>					
SHJ267	03-756-QCFP	Orange/White	Quebec only	-	148.00
<b>BASE</b>					
SAS372	03-732-WR	Base	-	15	15.00
SEC002	03-732	Base	-	20	40.50

## GRIP N GO™ TRIM LINE CHANNELIZERS

- Utilizes less space than traditional traffic drums
- Handle accommodates most barricade lights
- Made of impact resistant polyethylene material
- Model SEJ659 meets NCHRP-350 crash certification and MUTCD standards
- Model SEJ660 conforms to ON standard (MTO) for TC-52 channelizers
- Tapered stackable design
- Overall height 49": channelizer 42" H, handle 7" H
- Channelizer base measures 8" W
- Choice of 10-lb. square base or 16-lb. octagon shaped base sold separately



SEJ660



SEJ659



Model No.	Mfg. No.	Description	Price /Each
<b>CHANNELIZERS</b>			
SEJ659	03-7508-5HI	Black w/Orange Stripes	35.20
SEJ660	03-750-4HI	Orange w/White Stripes	38.30
<b>BASE</b>			
SEE893	03-752-10	10-lb. Square Base	19.10
SC104	03-752-16	16-lb. Octagon Base	30.30

## TRAILBOSS CHANNELIZER DRUMS

- Constructed of high density polyethylene
- Drum designed to inhibit roll after impact to eliminate further hazards or potential damage
- Tapered drum design enables nesting for storage or transport
- Drum handle accommodates one or two Type A or C lights designed to be attached with a standard size bolt and bolt protector
- Meets MUTCD and NCHRP-350 requirements with or without barricade lights
- Drum height: 41.27"
- Drum diameter (at bottom): 23"
- Base sold separately



SAS572



SAS573



Model No.	Mfg. No.	Reflective Stripes	Price /Each
<b>CHANNELIZERS</b>			
SAS571	03-780-4HI	High Intensity Grade	95.90

## ACCESSORIES

Model No.	Mfg. No.	Description	Price /Each
SAS572	03-732-25	Molded Base, 25 lbs.	50.10
SAS573	03-750-TRG	Tire Ring Base, 22.5 lbs.	21.30



## SNOW FENCE

- Provides an economical, easy and reliable protection barrier
- Lightweight, reusable and durable for easy handling
- Made of strong high density polyethylene with high tear resistance
- Stronger than competitive non-oriented fence
- High visibility colour
- Can also be used as a safety warning barrier
- Colour: Orange
- Roll Length: 50'
- Roll Width: 4'
- Weight: 4 lbs.

Model No. SHB329  
Price/Each \$20.25

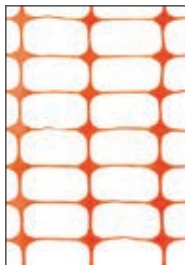

## HEAVY-DUTY SAFETY FENCE

- Protects plants from freezing rain and heavy snowfall
- Provides an economical, easy and reliable protection barrier
- Lightweight, reusable and durable for easy handling
- Made of strong high density polyethylene with high tear resistance
- Stronger than competitive non-oriented fence
- Acts as a safety warning barrier
- Colour: Orange
- Roll Length: 100'
- Roll Width: 4'
- Weight: 19 lbs.

Model No. SHC245  
Price/Each \$67.95

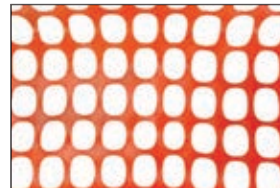

## IMPACT RESISTANT DELINEATOR

- Tubular surface mount delineator is a high performance, surface mounted, flexible plastic chennelization and delineation device
- Can be bonded to asphalt or concrete surfaces to provide traffic control in areas requiring easy removal or relocation
- Provides excellent impact resistance and rebounds after impact
- Comes with a base and 3" x 6" Hi-Intensity reflective white sheeting on the post

SFJ592

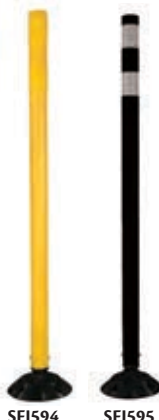

SFJ594 SFJ595



Model No.	Mfg. No.	Height"	Colour	Price /Each
SFJ593	04-36-WWG	36	White	70.40
SFJ594	04-36-YYG	36	Yellow	70.40
SFJ595	04-36-BWG	36	Black	70.40
SFJ596	04-36-OWG	36	Orange	70.40
SFJ597	04-48-WWG	48	White	82.10
SFJ598	04-48-YYG	48	Yellow	82.10
SFJ599	04-48-BWG	48	Black	82.10
SFJ600	04-48-OWG	48	Orange	82.10
SFJ592	04-10-Base	Base for Impact Resistant Delineator		17.10

## REMOVABLE ORNAMENTAL STEEL BOLLARDS

- Provides attractive yet functional barrier for vehicle access and parking
- Locks into galvanized steel socket cemented into ground (padlock not included)
- Cover plate on socket protects hole, leaving no protrusion above the surface after removal
- Dimensions: 4 1/2" dia. with 6" diameter rings
- Height: 40"
- Weight: 84 lbs.
- Finish: Powder black coating for durability

Model No. KH820  
Price/Each \$835.00



## POLYETHYLENE BOLLARD COVERS

- Enhance and protect the appearance of your steel bollards
- Reduce maintenance; avoid scraping and painting each spring
- Constructed of 1/8" UV stable polyethylene for durability
- Easy installation with patented GripperTabs™ included
- Colour: Safety yellow with reflective red tape or high visibility red with white reflective tape, for great visibility day or night
- 5-year warranty against fading and cracking



Yellow Model No.	Red Model No.	Fits Bollard Diameter"	Fits Bollard Length"	Wt. lbs.	Price /Each
KH806	KH836	4/1/2	52	7	105.00
KH808	KH838	4-1/2	64	9	119.00
KH809	KH839	6-5/8	52	8	125.00
KH810	KH840	6-5/8	60	9	139.00
KH811	KH841	6-5/8	72	10	159.00

## PORTABLE SAFETY ZONE

- Quickly creates a safe and complete visual barrier zone in virtually unlimited indoor applications
- Simple set-up and take-down
- Slim design takes little space and allows for easy storage
- Lightweight and balanced for easy transportation by one operator
- Robust construction in "safety orange" powder coated steel
- Comes complete with 100' safety orange fencing, 4 posts, 4 rubber base pads and 4 magnetic fence clips
- Easily fits through 30" doorways
- Suitable for both indoor and outdoor applications on smooth surfaces



Model No.	Mfg. No.	Description	Price /Each
SDP585	70-6030	Portable Safety Zone	2099.00
SDP586	70-6036	Optional LED Lights	40.50

SDP585



SDP586

## RAPID ROLL BARRIERS

- Extended Length: 50'
- Material: Plastic

### WHEELED BARRIERS

- Reflective safety tape is fitted on both sides of the cartridge
- Orange cartridge and raised profile fencing
- Includes 4 x orange posts with end lockout and 4 rubber bases

### 3-LEGGED BARRIERS

- Reflective safety tape is fitted on both sides of the cartridge
- Orange cartridge and raised profile fencing
- Includes 4 x orange posts with end lockout and 4 rubber bases
- Steel cartridge base



## TRAFFIC BARRIERS

- Rugged plastic traffic barricades are perfect for a variety of applications
- Can be filled with sand or water, and quickly emptied for easy transportation
- Colour: Orange



SFU851

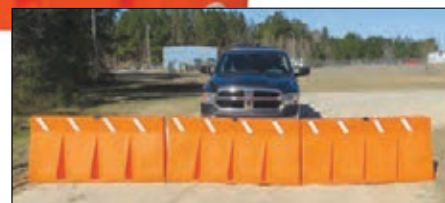

## RAPID ROLL™

Model No.	Mfg. No.	Description	Height"	Wt. lbs.	Price /Each
SFU863	70-7050	Wheeled	64	215	1859.00
SFU864	70-7000	3-Legged	57.5	183	1645.00



Model No.	Mfg. No.	Height"	Length"	Price /Each
SFU851	TB-5-10	24	62 1/4	496.00
SFU004	TB-6-10	33 3/4	69 3/4	909.00

## BARRICADE LIGHTS

- Incandescent, 6-V barricade light
- Has a lamp life of 2000 hours and flashes 55 to 75 flashes per minute
- Can be set for flash or steady burn
- High clarity polycarbonate lens provides extreme durability
- Attaches to most barricades and channelizers with a bolt
- Meets all MUTCD and ITE specifications
- Requires two 6 V batteries (not included)
- Colour: Amber
- Light Dia.": 7
- Overall Dimensions: 7 1/2 L" x 5 1/2 W" x 11 1/2 H"
- Includes photocell

Model No. SEM242  
Mfg. No. 03-10-3WAY6V  
Price/Each \$39.00



## LED SUNDOWNER BARRICADE LIGHT

- Barricade lights are the perfect way to visually draw call attention to your workzone in the dark
- Meets MUTCD Standards
- ITE Certified
- Operates with 4 D-Cell Batteries
- 3 modes (flashing, steady burn, off)
- LED lights located in strongest area of the case
- Simple one piece battery compartment
- Durable protected LED lighting assembly
- Lens Colour: Amber
- Case Colour: Yellow

Model No. SAR344  
Mfg. No. 03-10-WAYDC  
Price/Each \$38.30



## PORTABLE INTERLOCKING BARRIERS

- Ideal for directing people in areas where crowd control is required
- Rugged welded steel construction
- Feet are removable so railing will lay flat for shipping and storage
- Includes connectors to attach multiple units together
- Overall size is 102" L x 40" H
- Distance between vertical bars: 7"
- Rail diameter: 1 5/8"
- Weight: 56 lbs.



**ZENITH**  
Safety Products

Model No.	Description	Price /Each
SEE395	Galvanized Finish	225.00
SEE396	Safety Yellow Finish	235.00

## PLASTX™ A-FRAME BARRICADE

- Ideal as a temporary or long term solution to cordon off areas
- Patented PlastX™ will not rot, rust, crack or peel and is chemical resistant
- ADA compliant to MUTCD standards
- For a complete unit order two legs and one board, add a second board for increased stability

### PLASTX™ A-FRAME BARRICADE LEG

- Mounting holes will accommodate all manufactured boards
- Holds up to two 8' L x 2" W x 8" H boards
- 26" L x 2" W x 42" H
- Available in white or orange

### PLASTX™ A-FRAME BARRICADE T-BOARD

- 7 years UV package protects against deterioration
- Made of extruded grade PVC
- Available with hi-intensity stripes or engineer grade stripes
- 8' L x 2" W x 8" H
- Available in black and orange stripes or white and orange stripes



Model No.	Mfg. No.	Colour	Price /Each
<b>BARRICADE LEG</b>			
SEI202	97-01-004	White	42.20
SEI203	97-01-0040	Orange	46.10
<b>T-BOARD</b>			
SEI204	97-01-0298-02	Black and Orange Stripe	90.60
SEI205	97-01-029-02	White and Orange Stripe	97.00

## EXPANDABLE BARRIERS

- Aluminum construction with stainless steel hardware
- Collapsible design allows for easy storage when not in use
- Lightweight and free standing for easy setup when needed
- Side hook allows multiple units to be used together
- Expanded width: 11'
- Height: 37"
- Weight: 20 lbs.
- Colour: Black and yellow



**ZENITH**  
Safety Products

Model No.	Description	Price /Each
SDK990	Expandable Barrier	349.00
SDK991	Optional Caster Set	30.95

## PORTABLE MOBILE BARRIERS

- Mobile safety barrier for indoor applications
- Flexible panels allow multiple configurations, including straight, curved or round
- Includes four locking straps for easy storage
- Tilts and rolls easily
- This item is shipped fully assembled and ready for immediate use



**ZENITH**  
Safety Products

Model No.	Expanded Length'	Height	Price /Each
SG0660	13	40"	599.00

## STREET BARRICADES



- Ideal for construction and utility repair, warn of hazardous areas
- Reflective striping wood board, 2" thick x 6" wide x 8' long
- Board is inserted on iron supports, on orange steel A-frame legs
- O.A. height of legs: 4'
- All components sold individually
- For complete unit, order two iron supports and one barricade board

Model No.	Description	Price/Each
SAO203	Orange A-Frame Support	105.00
SAO204	Barricade Board	185.00

## XPANDIT PLASTIC BARRICADE

- Made of durable recyclable polypropylene
- Expandable plastic barricade providing an attractive, visible warning barrier
- Barricade is weatherproof and can be used outdoors
- Maintenance free and contains no parts that will rust or corrode
- Retracts and expands up to 11 1/2', but folds down to a compact 16 1/2" x 3' high
- Plastic feet will not scratch or mar expensive floors
- Weight: 15 lbs.



Model No.	Expanded Length'	Height"	Price /Each
SAQ195	11.5	36	462.00



## TRUEGRIP® GENERAL PURPOSE NON-SKID TAPE

- Silicon Carbide 46-grit mineral abrasive surface
- Good abrasion, chemical and water resistance
- Meets NFSI 101-A, ANSI B101.1, OSHA 1910.24, and 1910.26
- Colour: Black
- 60' roll



**INCOM**

Model No.	Mfg. No.	Width"	Price /Each
SEC957	SG7001CB	1	33.90
SEC958	SG7002CB	2	51.90
SEC959	SG7004CB	4	129.00
SEC960	SG7006CB	6	179.00
SEC961	SG7012CB	12	375.00

## ANTI-SKID TAPE

- Helps prevent injuries from slipping and falling
- Grit sandpaper surface with adhesive backing
- Water, grease, and oil resistant
- Ideal for both indoor and outdoor applications
- Pre-cut sizes with rounded corners offer a finished look and prevents the corners from lifting
- Meets or exceeds NFSI 101-A and OSHA 1910.24 and 1910.26
- RoHS compliant
- Thickness: 0.78 mm (30 mil)
- Temperature Range: 175°F to -20°F
- Application range: 95°F to 50°F
- Grit: 60

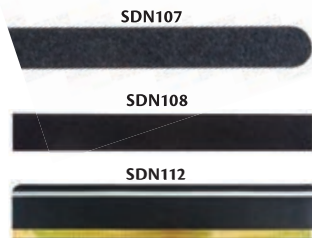

**ZENITH**  
Safety Products



Model No.	Dimensions W" x L"	Description	Qty /Pack	Price /Each
SDN107	3/4 x 24	Rounded Edge Strip	50	34.45
SDN108	3 x 24	Strip	50	115.00
SDN109	6 x 24	Strip	50	220.00
SDN110	6 x 30	Strip	50	285.00
SDN111	5 1/2 x 5 1/2	Square	50	63.75
SDN112	6 x 24	Strip w/Reflective Band	10	200.00
SDS936	6 x 24	Black/Yellow Strip	1	6.85

## ANTI-SKID TAPE

**ZENITH**  
Safety Products

- Helps prevent injuries from slipping and falling
- Grit sandpaper surface with adhesive backing
- Water, grease, and oil resistant
- Ideal for both indoor and outdoor applications
- Meets or exceeds NFSI 101-A and OSHA 1910.24 and 1910.26
- RoHS compliant
- Length: 60'
- Grit: 60

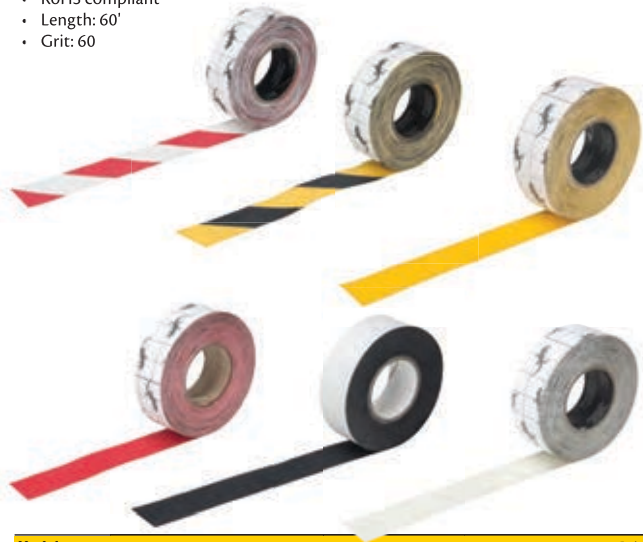

Model No.	Width"	Colour	Price /Each
SDN088	2	Red/White	41.45
SDN089	2	Black/Yellow	41.45
SDN090	2	Yellow	41.45
SDN091	2	Red	41.45
SDN098	1	Black	15.75
SDN099	2	Black	29.35
SDN100	4	Black	58.95
SDN101	6	Black	88.55
SDN102	12	Black	179.00
SDN103	1	Clear	22.50
SDN104	2	Clear	40.75
SDN105	4	Clear	81.35
SDN106	6	Clear	110.00

## SAFESTEP® ANTI-SLIP SOLUTIONS

- Immediately creates a durable, safe and slip resistant surface
- Ideally suited for stairs, landings, platforms, ramps, ladders and wash down areas
- Virtually indestructible; withstands vehicle and forklift traffic
- Corrosion and chemical resistant
- Excellent slip-resistance, even when wet
- Easy glue and screw installation



**RUST-OLEUM**

Model No.	Mfg. No.	Description	Grit	Dimensions W" x L"			Colour	Price /Each
SDN798	271795	Step Cover	Coarse	10	x	36	Black & Yellow	251.00
SDN799	271796	Step Cover	Coarse	10	x	48	Black & Yellow	335.00
SDN790	271819	Step Edge	Coarse	2 3/4	x	36	Yellow	95.50
SDN791	271820	Step Edge	Coarse	2 3/4	x	48	Yellow	125.00
SDN794	292461	Step Cover	Medium	10	x	36	Black & Yellow	251.00
SDN787	292483	Step Edge	Medium	2 3/4	x	36	Yellow	95.50
SDN788	292484	Step Edge	Medium	2 3/4	x	48	Yellow	125.00

# MARKING TAPES

## 3M™ SAFETY-WALK™ SLIP RESISTANT TAPES

The easy, economical way to help prevent slips and falls, and help meet OSHA and ADA requirements.

### GENERAL PURPOSE

- Mineral-coated, slip-resistant material features a highly durable surface
- Low-profile design reduces trip hazard
- Available in a variety of colors and sizes

### CONFORMABLE

- High-friction, slip-resistant material has a special aluminum backing that conforms around corners and adheres to irregular surfaces
- Available in black and safety yellow in a range of sizes

### MEDIUM RESILIENT

- Resilient, non-mineral, slip-resistant material
- Soft surface is suitable for bare feet
- Available in black and gray in a variety of sizes



Model No.	Mfg. No.	Colour	Description	Dim. W x L	Price /Each
<b>GENERAL PURPOSE</b>					
NG062	F-610-BLK-3/4X60	Black	Roll	3/4" x 60'	38.00
NG063	F-610-BLK-1X60	Black	Roll	1" x 60'	50.65
NG064	F-610-BLK-2X60	Black	Roll	2" x 60'	101.31
NG067	F-610-BLK-6X24	Black	Strips (50/pkg.)	6" x 24"	541.33
<b>CONFORMABLE</b>					
NG073	F-510-BLK-2X60	Black	Roll	2" x 60'	132.50
NG074	F-510-BLK-4X60	Black	Roll	4" x 60'	265.00
NG075	F-510-BLK-6X60	Black	Roll	6" x 60'	397.41
NG077	F-530-SYL-2X60	Yellow	Roll	2" x 60'	132.50
<b>MEDIUM RESILIENT</b>					
NG082	F-310-BLK-2X60	Black	Roll	2" x 60'	126.99
NG083	F-310-BLK-6X60	Black	Roll	6" x 60'	381.11
NG085	F-370-GRY-1X60	Grey	Roll	1" x 60'	63.49
NG086	F-370-GRY-2X60	Grey	Roll	2" x 60'	126.99



## ADHESIVE ANTI-SLIP FLOOR SIGNS

- Aggressive adhesive will adhere to most smooth, clean and dry floors
- Laminate textured vinyl for added durability and slip resistance
- Will stand up to heavy pedestrian traffic
- High quality adhesive vinyl
- Thickness: 1/32"
- Language: English
- Material: Plastic
- Height: 17"
- Width: 17"



## INCOM

Model No.	Description	Price/Each
SFU877	Stop Floor Sign	53.90
SFU878	Warning Forklift Traffic	53.90
SFU879	Safety Glasses Required	56.50
SFU880	Pedestrian Crossing	56.50
SFU881	Safety Footwear Required	56.50
SFU882	Keep Aisle Clear	56.50
SFU883	Keep Aisle Clear	56.50
SFU884	Emergency Shower	56.50
SFU885	Yield	56.50
SFU886	Eye Wash Fountain	56.50

## BIG FOOT™ ANTI-SLIP FLOOR COATINGS

### HEAVY-DUTY PEDESTRIAN GRADE

- For areas with heavy pedestrian or light rolling traffic
- Ideal for ramps, walkways, locker rooms, stairs and assembly areas
- Resists gasoline, oil, acids, alkalis and aliphatic solvents
- Fire retardant when cured

Model No.	Mfg. No.	Description	Colour	Coverage Ft <sup>2</sup>	Price /Each
AA603	1602679	1 gallon	Black	50	269.00
AA604	1602121	1 gallon	Grey	50	309.00

AA603



## SNOW FLAGS

- 9" x 12" triangle-shaped flag with 6' fiberglass pole
- Mark fire hydrants, valves, trails, or other landmarks in snow-prone areas
- Flags are made of high-visibility, red vinyl fabric able to withstand low temperatures
- Flag Pole Diameter: 1/2"
- Height: 6'
- Colour: Red



Model No.	Price /Each
SGG309	7.85

## PENNANT STRINGS

- Used to draw attention at events, work areas or construction sites
- String Length: 60'
- Pennant Size: 9" x 12"
- Number of Pennants: 36
- Flag Material: Polyethylene



SGG313

Model No.	Colour	Price /Each
SGG311	Red	6.40
SGG312	Yellow	6.40
SGG313	Multicolour	7.30

## TOUGHSTRIP™ FLOOR MARKING TAPE

- Made with Brady's new B-514 polyester
- Ideal for marking aisles, passageways and storage locations, pointing out important safety equipment and egress pathways
- Service temperature range of 0°F-129°F
- Resists harsh chemicals
- Exceeds safety standards for clean, dry non-slip surfaces
- 100' per roll



### FLOOR MARKING TAPE - 2"

Model No.	Mfg. No.	Width"	Colour	Price /Each
SED030	104311	2	White	80.99
SED031	104313	2	Red	80.99
SED032	104315	2	Green	80.99
SED033	104314	2	Blue	80.99
SED034	104312	2	Yellow	80.99
SED035	104317	2	Black/Yellow	80.99

### FLOOR MARKING TAPE - 3"

Model No.	Mfg. No.	Width"	Colour	Price /Each
SED036	104341	3	White	118.99
SED037	104343	3	Red	118.99
SED038	104345	3	Green	118.99
SED039	104344	3	Blue	118.99
SED040	104342	3	Yellow	118.99
SED041	104347	3	Black/Yellow	118.99

## FLAGGING TAPE

- Quick and easy way to lay out boundaries
- Non-adhesive
- Brightly coloured tape offers maximum visibility
- Material: Vinyl



Model No.	Colour	Dimensions			Price /Each
		W"	x	L'	
SGQ805	Fluorescent Orange	1.1875	x	164	2.95
SGQ806	Red	1.1875	x	164	2.95
SGQ807	Fluorescent Pink	1.1875	x	164	2.95
SHB928	Fluorescent Green	1.1875	x	164	2.95
SHB929	Fluorescent Yellow	1.1875	x	164	2.95
SGQ808	Blue	1.1875	x	328	3.10

## CONSPICUITY TAPE

- Impact proof
- UV stable
- Increases visibility in low light or poor visibility situations
- Easy to cut and apply
- Ideal for use on trailers, vehicles, for towing, industrial equipment
- Format: Roll
- Width: 2"
- Length: 150'
- Standard(s) Met: FMVSS108, the Standard Set by the Department of Transportation



Model No.	Description	Colour	Price /Each
SGU268	-	White	125.00
SGU269	6" white, 6" red alternating pattern	Red & White	125.00
SGU270	7" white, 11" red alternating pattern	Red & White	125.00

## AISLE MARKING TAPE

- Strong and durable tape that will adhere to most clean surfaces
- Can be used on floors, walls and equipment
- Blue is commonly used for general information
- Material: PVC
- Roll Length: 108'
- Thickness: 6 mil



Model No.	Colour	Width"	Price /Each
SGW126	Blue	2	5.65
SGW127	Orange	2	5.65
SGW128	Green	2	5.65
SGW129	Red	2	5.65
SGW130	White	2	5.65
SGW131	Yellow	2	5.65
SGW132	Black	2	5.65



### RECOMMENDED GUIDELINES

- Blue:** General Information
- White:** Traffic and Housekeeping
- Orange:** Warning/Hazardous Biohazard
- Yellow:** Caution
- Green:** Safety and First Aid Equipment
- Black:** Boundaries
- Red:** Fire Protection/Danger/Stop
- Stripes:** Hazard/Warning



# MARKING TAPES

## HAZARD WARNING TAPE

### NON-LAMINATED

- PVC tapes will quickly bring attention to any workplace hazard
- Made from a 6-mil conformable vinyl film with a rubber adhesive system to adhere to most any clean, dry surface
- Smooth semi-matte surface
- Ideal for floors, walls, pipes and equipment
- 108' per roll

### LAMINATED

- PVC tape with a durable, clear laminating film over top
- Smooth gloss finish will resist wear and is easily cleaned
- Over-lamination improves tape's ability to withstand heavy abrasion
- 108' per roll

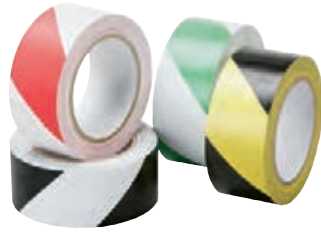

### RECOMMENDED GUIDELINES

#### Red/White

Fire Protection Equipment



#### Yellow/Black

Physical Hazards



#### Black/White

Traffic and Housekeeping



#### Green/White

Safety and First Aid Equipment



Model No.	Mfg. No.	Width"	Colour	Price /Each
<b>NON-LAMINATED</b>				
SAL701	WT2300	2	Black/White	19.90
SAL697	WT2110	2	Yellow/Black	19.90
SAL699	WT2200	2	Red/White	19.90
SAL702	WT2310	3	Black/White	30.90
SAL698	WT2130	3	Yellow/Black	28.90
SAL700	WT2210	3	Red/White	30.90
<b>LAMINATED</b>				
SAL668	LWT221	2	Red/White	30.90
SAL667	LWT220	2	Yellow/Black	27.90
SAL669	LWT222	2	Black/White	30.90
SAL670	LWT223	2	Green/White	30.90
SAL672	LWT321	3	Red/White	47.90
SAL671	LWT320	3	Yellow/Black	45.90
SAL673	LWT322	3	Black/White	47.90
SAL674	LWT323	3	Green/White	48.90
SAL676	LWT421	4	Red/White	63.90
SAL675	LWT420	4	Yellow/Black	60.90
SAL677	LWT422	4	Black/White	63.90
SAL678	LWT423	4	Green/White	63.90
SAL680	LWT621	6	Red/White	95.90
SAL679	LWT620	6	Yellow/Black	95.50
SAL681	LWT622	6	Black/White	95.90
SAL682	LWT623	6	Green/White	95.90



## ENGINEER GRADE REFLECTIVE TAPE

- Offer vibrant daytime visibility with reflective properties for night time use
- Rated for use outdoors for a 7-year life span
- Aggressive adhesive that will adhere to almost any clean, dry, smooth surface
- Hazard striped products have a protective lamination to ensure the printed stripe will not wear off
- Comes with removable release liner
- Not intended for flexible vehicle graphics
- 30' roll



Model No.	Mfg. No.	Width"	Colour	Price /Each
SN611	RST106	2	Black/Yellow	67.90
SN612	RST107	2	Red/White	67.90
SAS555	RST101	2	White	42.90
SAS556	RST102	2	Red	42.90
SAS557	RST104	2	Yellow	41.90
SAS558	RST105	2	Orange	42.90

## GLOW IN THE DARK TAPE

- Protect your workers during darkness or evacuation
- Glow in the dark material automatically absorbs energy from any light source
- Vinyl-coated on one side with a pressure-sensitive adhesive
- Perfect to locate emergency equipment and identify evacuation routes during emergency situations
- 30' roll



Model No.	Mfg. No.	Width"	Price /Each
<b>PLAIN</b>			
NC938	523522P	2	98.50
NC939	523524P	4	209.00
NC940	523526P	6	309.00
<b>BLACK STRIPES</b>			
SAS545	GT230BK	2	139.00
SAS546	GT430BK	4	259.00
SAS547	GT630BK	6	395.00
<b>RED STRIPES</b>			
SAS548	GT230RD	2	129.00
SAS549	GT430RD	4	259.00
SAS550	GT630RD	6	395.00

## COLOURED VINYL ARROWS

- Great choice for marking direction of travel or demarcation of hazards
- Commonly used for production work flow, inventory management and pedestrian directional aids
- Arrows are all made from a durable solid coloured vinyl so there is no print to wear off
- Adhesive backing
- Custom sizes and colours available upon request



Model No.	Mfg. No.	Colour	Price /Each
<b>4" - 100 PER ROLL</b>			
SAS533	VA400W	White	39.90
SAS534	VA400K	Black	39.90
SAS535	VA400G	Green	39.90
SAS536	VA400R	Red	38.50
SAS537	VA400B	Blue	39.90
SAS538	VA400Y	Yellow	39.90

## BARRICADE TAPE

- Barricade tapes warn against hazards or dangerous work zones in light duty construction projects
- Ideal for temporary use outdoors or permanent indoor warning
- Made from a low-density polyethylene film with a black printed image on one side
- Length: 1000'
- Width: 3"



## INCOM®

### ENGLISH BARRICADE TAPE

Model No.	Mfg. No.	Description	Colour	Price /Each
<b>STANDARD - 2.0 MIL</b>				
SFV836	BT1025	Caution High Voltage	Black on Yellow	38.50
SFV837	BT1026	Caution Keep Out	Black on Yellow	38.50
SFV838	BT1001	Danger Do Not Enter	Black on Red	37.50
SFV839	BT1044	Caution Do Not Enter	Black on Yellow	20.50
<b>HEAVY-DUTY - 3.0 MIL</b>				
SGC178	TNBT57	Danger	Black on Red	24.90
SGC179	TBBT44	Caution Do Not Enter	Black on Yellow	24.90
SGC180	TNBT31	No Legend	Black on Yellow	24.90
SGC182	TNBT56	Danger	Black on Yellow	23.90
SFV843	TNBT37	Caution Construction Area	Black on Yellow	24.90
SFV844	TNBT25	Caution High Voltage	Black on Yellow	24.90
SFV845	TNBT30	Caution Wet Paint	Black on Yellow	24.90
SFV846	TNBT39	Caution Workmen Above	Black on Yellow	24.90

### BILINGUAL BARRICADE TAPE

Model No.	Mfg. No.	Description	Colour	Price /Each
<b>HEAVY-DUTY - 3.0 MIL</b>				
SGC181	TNBT13	Attention Zone de Construction/ Caution Construction Zone	Black on Yellow	24.90
SGC185	TBNT14	Entrée Interdite/ Caution Do Not Enter	Black on Yellow	24.90

### FRENCH BARRICADE TAPE

Model No.	Mfg. No.	Description	Colour	Price /Each
<b>HEAVY-DUTY - 3.0 MIL</b>				
SGC183	TNBT16	Danger Entrée Interdite	Black on Red	23.90
SGC184	TNBT15	Espace Restreint-Entrée Interdite	Black on Yellow	24.90

## FLOOR TAPE APPLICATORS

- Designed for applying tape accurately and securely to floors and ground
- Economy style designed to apply tape in straight lines only; accepts tape roll widths up to 4"



## INCOM®

Model No.	Mfg. No.	Max. Roll Diameter"	Overall Height"	Price /Each
SED019	WTD-200	4	39	429.00

## BARRICADE TAPE

- Warn against hazards by restricting entry to dangerous areas
- Ideal for both indoor and temporary outdoor usage
- Made of polyethylene



Model No.	Message	Colour	Roll Size	Price /Each
<b>STANDARD DUTY - 1.5 MIL</b>				
SEK397	Caution	Black on Yellow	3" x 1000'	10.55
SFJ602	Caution	Black on Yellow	3" x 300'	4.85
SEK398	Attention	Black on Yellow	3" x 1000'	10.55
SEK399	Danger	Black on Red	3" x 1000'	10.55
SDS739	Danger	Black on Yellow	3" x 1000'	10.55
<b>HEAVY-DUTY - 2.0 MIL</b>				
SEK400	Caution	Black on Yellow	3" x 1000'	15.95
SEK401	Attention	Black on Yellow	3" x 1000'	15.95
SEK402	Danger	Black on Red	3" x 1000'	15.95
<b>EXTRA HEAVY-DUTY - 2.5 MIL</b>				
SEK403	Caution	Black on Yellow	3" x 1000'	17.95
SEK404	Attention	Black on Yellow	3" x 1000'	17.95
SEK405	Danger	Black on Red	3" x 1000'	17.95
SDS740	Danger	Black on Yellow	3" x 1000'	17.95

## REINFORCED BARRICADE TAPE

- Offers the ultimate in durability on the jobsite
- Printed on a material similar to that used in manufacturing sandbags, these tapes do not stretch or break under normal stress conditions
- Keeps its shape in the rain and can withstand very strong winds
- Thickness: 5 mils
- Length: 500'
- Width: 3"



## INCOM®

Model No.	Mfg. No.	Message	Colour	Price /Each
SGC187	REBT2058	Caution	Black on Yellow	109.00
SGC186	REBT2057	Danger	Black on Red	109.00

## TEMPORARY PAVEMENT MARKING TAPE

- Ideal for parking lots and work sites
- 4" W x 50 yard roll comes with a weather resistant adhesive
- Choice of white or yellow construction grade rolls



Model No.	Mfg. No.	Description	Price /Each
SC144	03-10-105	White	127.00
SC145	03-10-106	Yellow	127.00

# CROWD CONTROL

## FREE-STANDING CROWD CONTROL BARRIERS

- 4-way connection permits all posts to receive up to three tapes from any direction
- Slow retracting tape cassette insures tape will retract safely
- Specially designed locking mechanism prevents accidental release
- Receiver post without tape cassettes for use at the end of a line of posts
- Height: 35"
- Recommended post spacing:
  - 7' Tape = 6'6"
  - 12' Tape = 11'6"



### WITHOUT WHEELS

Model No.	Tape Colour	Message/ Tape Design	Tape Length'	Price /Each
<b>STAINLESS STEEL BARRIERS</b>				
SAS226	Red	-	7	184.00
SEA794	Black	-	7	184.00
SDN298	Yellow	-	7	184.00
SDN299	Yellow	Caution Do Not Enter	7	205.00
SDN300	Yellow	Attention Ne Pas Entrer	7	205.00
SDN301	Blue	-	7	184.00
SDN302	Green	-	7	184.00
SDN303	Black/White	Black with White Stripe	7	205.00
SDN304	Yellow/Black	Yellow & Black Stripes	7	205.00
SDL100	Red	-	12	205.00
SDN771	Black	-	12	205.00
SDN772	Yellow	-	12	205.00

### STEEL - BLACK BARRIERS

SDN305	Red	-	7	163.00
SAS227	Black	-	7	163.00
SDN306	Yellow	-	7	163.00
SDN307	Yellow	Caution Do Not Enter	7	188.00
SDN308	Yellow	Attention Ne Pas Entrer	7	188.00
SDN309	Blue	-	7	163.00
SDN310	Green	-	7	163.00
SDN311	Black/White	Black with White Stripe	7	188.00
SDL987	Yellow/Black	Yellow & Black Stripes	7	188.00
SDN773	Red	-	12	188.00
SDL101	Black	-	12	188.00
SDN774	Yellow	-	12	188.00

### STEEL - YELLOW BARRIERS

SDN312	Red	-	7	145.00
SDN313	Black	-	7	145.00
SAS228	Yellow	-	7	145.00
SAS229	Yellow	Caution Do Not Enter	7	165.00
SEE818	Yellow	Attention Ne Pas Entrer	7	165.00
SDN314	Blue	-	7	145.00
SDN315	Green	-	7	145.00
SDN316	Black/White	Black with White Stripe	7	165.00
SDN317	Yellow/Black	Yellow & Black Stripes	7	165.00
SDN775	Red	-	12	165.00
SDN776	Black	-	12	165.00
SDL102	Yellow	-	12	165.00

### RECEIVER POSTS, WITHOUT WHEELS

Model No.	Description	Price /Each
SAS230	Stainless Steel	151.00
SAS231	Black - Steel	138.00
SAS232	Yellow - Steel	123.00

### WITH WHEELS

Model No.	Tape Colour	Message/ Tape Design	Tape Length'	Price /Each
<b>STAINLESS STEEL BARRIERS</b>				
SEI760	Red	-	7	210.00
SDN318	Black	-	7	210.00
SDN319	Yellow	-	7	210.00
SDN320	Yellow	Caution Do Not Enter	7	239.00
SDN321	Yellow	Attention Ne Pas Entrer	7	239.00
SDN322	Blue	-	7	210.00
SDN323	Green	-	7	210.00
SDN324	Black/White	Black with White Stripe	7	239.00
SDN325	Yellow/Black	Yellow & Black Stripes	7	239.00
SDL103	Red	-	12	239.00
SDN777	Black	-	12	239.00
SDN778	Yellow	-	12	239.00

### STEEL - BLACK BARRIERS

SDN326	Red	-	7	185.00
SDN327	Black	-	7	185.00
SDN341	Yellow	-	7	185.00
SDN328	Yellow	Caution Do Not Enter	7	210.00
SDN329	Yellow	Attention Ne Pas Entrer	7	210.00
SDN330	Blue	-	7	185.00
SDN331	Green	-	7	185.00
SDN332	Black/White	Black with White Stripe	7	197.00
SDN333	Yellow/Black	Yellow & Black Stripes	7	210.00
SDN779	Red	-	12	210.00
SDL104	Black	-	12	210.00
SDN780	Yellow	-	12	210.00

### STEEL - YELLOW BARRIERS

SDN342	Red	-	7	165.00
SDN334	Black	-	7	165.00
SEI764	Yellow	-	7	165.00
SDN335	Yellow	Caution Do Not Enter	7	190.00
SDN336	Yellow	Attention Ne Pas Entrer	7	190.00
SDN337	Blue	-	7	165.00
SDN338	Green	-	7	165.00
SDN339	Black/White	Black with White Stripe	7	190.00
SDN340	Yellow/Black	Yellow & Black Stripes	7	190.00
SDN781	Red	-	12	190.00
SDN782	Black	-	12	190.00
SDL105	Yellow	-	12	190.00

### RECEIVER POSTS, WITH WHEELS

Model No.	Description	Price /Each
SEI761	Stainless Steel	174.00
SEI763	Black - Steel	154.00
SEI765	Yellow - Steel	142.00



## DUAL BELT CROWD CONTROL BARRIERS

- Slow retracting tape cassette insures tapes will retract safely
- Specially designed locking mechanism prevents accidental release
- 4-way connection permits all posts to receive up to three tapes from any direction
- Overall Height: 35"
- Material: Steel
- Tape Length: 12'



Model No.	Finish/Colour	Tape Colour	Legend	Price /Each
SHA661	Black	Red	Blank	199.95
SHA662	Black	Black	Blank	199.95
SHA663	Black	Black, White	Blank	215.00
SHA664	Stainless	Black	Blank	215.00
SHA665	Stainless	Red	Blank	215.00
SHA666	Yellow	Yellow	Blank	215.00
SHA667	Yellow	Yellow	Attention ne pas entrer	215.00
SHA668	Yellow	Yellow	Caution Do Not Enter	215.00

## SIGNS FOR CROWD CONTROL POST

- Sign holder to fit on top of existing Zenith® crowd control posts
- Ideal for hotels, airports, restaurants, movie theatres, stores, schools, offices, banks and more
- Great to help direct foot traffic, and easily and visually communicate with customers important information
- Material: Iron with black powder coating
- Dispenser holder dimensions: 17-7/8" H x 5-11/16" W
- Finish: Black

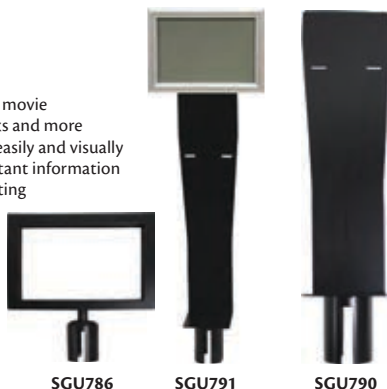

Model No.	Dimensions			Price /Each
	H"	x	W"	
<b>SIGN FRAMES ONLY</b>				
SGU786	7	x	10	44.95
SGU787	10	x	7	44.95
SGU788	10	x	14	47.50
SGU789	14	x	10	47.50
<b>DISPENSER HOLDER ONLY</b>				
SGU790	-	-	-	65.95
<b>SIGN FRAME &amp; DISPENSER HOLDER KIT</b>				
SGU791	7	x	10	64.50
SGU793	10	x	14	68.95

## WALL MOUNT BARRIER WITH TAPE CASSETTE

- Wall unit features smooth black finish
- Designed for controlling traffic in indoor areas where only a limited area of control is needed
- Attaches to magnetic surfaces
- Ideal where floor space is essential
- Material: Plastic
- Finish/Colour: Black
- Tape Colour: Black and Yellow
- Legend: Blank
- Tape Length: 15'
- Mounting Type: Magnetic Mount

Model No. SHH170  
Price/Each \$125.00



## WALL MOUNT BARRIERS

- Ideal where floor space is essential
- Slow retracting tape cassette ensures tape will retract safely
- Specially designed locking mechanism prevents accidental release
- Includes one wall receiver and hardware
- Dimensions: 3-5/8" L x 3" W x 5-5/8" H



### WALL MOUNT BARRIERS WITH MAGNETIC TAPE

- The magnetic end allows user to connect the tape to any metal surface
- End of tape for 12' models includes 3 magnets
- End of tape for 7' models includes 2 magnets



Model No.	Tape Colour	Message/Tape Design	Tape Length'	Price /Each
<b>STAINLESS STEEL WALL MOUNT BARRIERS</b>				
SDN560	Red	-	7	80.15
SED813	Black	-	7	80.15
SDN561	Yellow	-	7	80.15
SDN562	Yellow	Caution Do Not Enter	7	92.85
SDN563	Yellow	Attention Ne Pas Entrer	7	92.85
SDN564	Blue	-	7	80.15
SDN565	Green	-	7	80.15
SDN566	Black/White	Black with White Stripes	7	92.85
SDN567	Yellow/Black	Yellow & Black Stripes	7	92.85
SDN571	Red	-	12	92.85
SDN764	Black	-	12	92.85
SDN765	Yellow	-	12	92.85

Model No.	Tape Colour	Message/Tape Design	Tape Length'	Price /Each
<b>STEEL - BLACK WALL MOUNT BARRIERS</b>				
SDN554	Red	-	7	79.50
SAS233	Black	-	7	79.50
SEC074	Yellow	-	7	80.15
SEB178	Yellow	Caution Do Not Enter	7	92.85
SDN555	Yellow	Attention Ne Pas Entrer	7	93.75
SDN556	Blue	-	7	80.15
SDN557	Green	-	7	80.15
SDN558	Black/White	Black with White Stripes	7	92.85
SDN559	Yellow/Black	Yellow & Black Stripes	7	92.85
SDN568	Red	-	12	92.85
SDN569	Black	-	12	92.85
SDN570	Yellow	-	12	92.85

Model No.	Tape Colour	Message/Tape Design	Tape Length'	Price /Each
<b>BLACK FINISH - WALL MOUNT BARRIERS WITH MAGNETIC TAPE</b>				
SGQ993	Yellow/Black	Yellow & Black Stripes	7	96.80
SGQ994	Black	-	7	96.80
SGQ997	Yellow	Caution Do Not Enter	7	96.80
SGQ996	Yellow	Attention Ne Pas Entrer	7	96.80
SGQ999	Yellow	-	7	96.80
SGR001	Red	-	7	96.80
SGR002	Blue	-	7	96.80
SGQ992	Red	-	12	96.80
SGQ995	Yellow	-	12	96.80
SGQ998	Black	-	12	96.80

Model No.	Tape Colour	Message/Tape Design	Tape Length'	Price /Each
<b>STAINLESS FINISH - WALL MOUNT BARRIERS WITH MAGNETIC TAPE</b>				
SGR017	Yellow/Black	Yellow & Black Stripes	7	96.80
SGR018	Black	-	7	96.80
SGR021	Yellow	Caution Do Not Enter	7	96.80
SGR020	Yellow	Attention Ne Pas Entrer	7	96.80
SGR023	Yellow	-	7	96.80
SGR024	Red	-	7	96.80
SGR025	Blue	-	7	96.80
SGR016	Red	-	12	96.80
SGR019	Yellow	-	12	96.80
SGR022	Black	-	12	96.80

# SAFETY & INSPECTION MIRRORS



## DOMES MIRRORS

- Increase surveillance and prevent accidents due to blind corners
- Constructed of acrylic for added durability
- Comes with black protective edges
- Screw holes positioned on edge for easy mounting
- Full dome mirrors come with 4 hanging chains and hooks

### Ideal Locations:

- 360°** 4-way intersections
- 180°** T-intersections
- 90°** Corner intersections

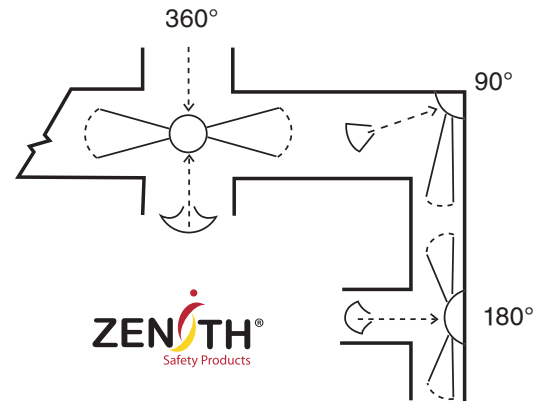

USE FURNITURE POLISH TO CLEAN MIRRORS. GLASS CLEANER WILL DAMAGE SURFACE.



FULL DOME – 360°

Model No.	Mirror Dia.™	Price /Each
<b>OPEN-TOP</b>		
SEJ875	20	99.95
SEJ876	24	139.00
SEJ877	31	259.00
SEJ878	47	525.00
<b>CLOSED-TOP - GALVANIZED STEEL BACKING</b>		
SDP520	18	161.00
SDP521	26	268.00
SDP522	32	340.00
SDP523	48	609.00

Note: Comes with hanging hardware



HALF DOME – 180°

Model No.	Mirror Dia.™*	Price /Each
<b>OPEN-TOP</b>		
SEJ879	20	65.95
SEJ880	24	79.95
SEJ881	31	136.00
SEJ882	47	265.00
<b>CLOSED-TOP</b>		
SDP524	18	135.00
SDP525	26	185.00
SDP526	32	260.00
SDP527	48	520.00

\* The dimensions listed are that of a full dome



QUARTER DOME – 90°

Model No.	Mirror Dia.™*	Price /Each
<b>OPEN-TOP</b>		
SEJ883	20	44.50
SEJ884	24	54.95

\* The dimensions listed are that of a full dome

## DROP-IN CEILING PANEL DOMES

- One-piece drop-in dome replaces a standard 2' x 2' drop-ceiling tile
- Dome provides 360° viewing for optimal surveillance
- Ideal for 4-way intersections
- Diameter: 24"



Model No.	Price /Each
SDP536	152.00

USE FURNITURE POLISH TO CLEAN MIRRORS. GLASS CLEANER WILL DAMAGE SURFACE.



## FLAT MIRRORS

- Offers optimal view with accurate depth perception
- Durable acrylic mirror
- Framed mirrors come with with galvanized steel back

UNFRAMED			FRAMED	
Dim. L" x W"	Model No.	Price /Each	Model No.	Price /Each
12 x 12	SDP510	67.25	SDP515	116.00
12 x 18	SDP511	76.45	SDP516	133.00
18 x 24	SDP512	126.00	SDP517	197.00
18 x 30	SGT377	139.00	SGT378	199.00
24 x 30	SDP513	189.00	SDP518	284.00
30 x 36	SDP514	279.00	SDP519	382.00



USE FURNITURE POLISH TO CLEAN MIRRORS. GLASS CLEANER WILL DAMAGE SURFACE.

## CONVEX MIRRORS WITH BRACKET

- Indoor/Outdoor
- Removes blind spots which reduces the chance of accidents caused by blind corners
- Includes installation bracket
- Durable acrylic convex mirror provides 100° viewing angle
- Plastic back and frame

BLACK			BEIGE	
Mirror Dia.™	Model No.	Price /Each	Model No.	Price /Each
12	SDP505	59.95	SDP500	62.25
18	SDP506	89.95	SDP501	93.50
26	SDP507*	139.00	SDP502*	145.00
30	SDP508*	180.00	SDP503*	189.00
36	SDP509*	235.00	SDP504*	235.00

\*Includes Extendable Arm

## CONVEX MIRRORS WITH TELESCOPIC ARM

- Indoor/Outdoor
- Removes blind spots which reduces the chance of accidents caused by blind corners
- Comes with telescopic arm
- Durable acrylic convex mirror provides 100° viewing angle
- Plastic back and frame

BLACK			BEIGE	
Mirror Dia.™	Model No.	Price /Each	Model No.	Price /Each
12	SGI547	59.95	SGI552	59.95
18	SGI548	89.95	SGI553	89.95
26	SGI549	139.00	SGI554	145.00
30	SGI550	180.00	SGI555	189.00
36	SGI551	235.00	SGI556	235.00



SDP500



USE FURNITURE POLISH TO CLEAN MIRRORS. GLASS CLEANER WILL DAMAGE SURFACE.



SGI547



## ROUNDTANGULAR CONVEX MIRRORS WITH BRACKET

- Indoor/Outdoor
- Designed to fit into smaller spaces
- Grants the same view as a full sized convex mirror but occupies a smaller area
- Ideal for blind spots near machinery and areas where mounting space is limited
- Includes installation bracket
- Durable acrylic mirror
- Rubber frame

PLASTIC BACK			GALVANIZED STEEL BACK	
Mirror Dia.™	Model No.	Price /Each	Model No.	Price /Each
12 x 18	SGI557	80.50	SGI561	150.00
18 x 26	SGI558*	129.00	SGI562*	245.00
20 x 30	SGI559*	175.00	SGI563*	297.00
24 x 36	SGI560*	219.00	SGI564*	399.00

\*Includes Extendable Arm



SGI561



USE FURNITURE POLISH TO CLEAN MIRRORS. GLASS CLEANER WILL DAMAGE SURFACE.



SGP528



## ROUNDTANGULAR CONVEX MIRRORS WITH TELESCOPIC ARM

- Indoor/Outdoor
- Designed to fit into smaller spaces
- Grants the same view as a full sized convex mirror but occupies a smaller area
- Ideal for blind spots near machinery and areas where mounting space is limited
- Comes with telescopic arm
- Durable acrylic mirror
- Rubber frame

PLASTIC BACK			GALVANIZED STEEL BACK	
Mirror Dia.™	Model No.	Price /Each	Model No.	Price /Each
12 x 18	SDP528	80.50	SDP532	150.00
18 x 26	SDP529	129.00	SDP533	245.00
20 x 30	SDP530	175.00	SDP534	297.00
24 x 36	SDP531	219.00	SDP535	399.00