



ELECTRICAL & INSTRUMENTS



HVAC.....	1102-1113
Fluorescent Tubes	1114
Emergency Lighting.....	1115-1116
Electrical Devices & Accessories	1117-1119
Flashlights.....	1120-1133
Batteries	1134
Task & Work Lighting	1135-1140
Extension Cords.....	1141-1151
Generators.....	1152-1155
Multimeters & Voltage Testers	1156-1158
Clamp Meters & Insulation Testers	1159
Process Meters & Decade Boxes.....	1160
Equipment Cases.....	1161-1162
Thermal Cameras	1163
Infrared Thermometers.....	1164
Thermometers	1165-1167
Environmental Meters.....	1168-1170
Solution Testing Meters	1171
Thickness, Coating & Hardness Meters.....	1172
Sound & Light Meters.....	1173
Speed, Distance & Length Measurers.....	1174-1175
Vibration, Force Gauges & Length Measurers	1176
Timers & Inspection Cameras.....	1177
Manometers.....	1178
Machinists Tools.....	1179
Scales.....	1180-1185



6" CLIP-ON & DESK FANS

- 2-speed, low and high settings
- Tilting head
- Fully assembled and ready for use
- Convertible clip and desk feature
- Weight: 2.21 lbs.
- Adjustable tilt

Model No. EA304
Price/Each \$32.00



Convertible
Clip Included



OSCILLATING DESK FANS WITH PUSH BUTTONS

- 3-speed push buttons controls
- Rotating or fixed air direction
- Portable and easy to assemble
- Topple resistant base
- Adjustable tilt



Model No.	Dia."	Wt. lbs.	Price /Each
EA305	12	3.5	52.00
EA306	16	5.1	67.00



16" WALL MOUNT OSCILLATING FANS

- Remote with timer mode included
- 3 speed with Eco mode feature
- Rotating or fixed air direction
- Easy to assemble
- Weight: 4.9 lbs.
- Adjustable tilt

Model No. EA526
Price/Each \$104.00



20" BOX FANS

- 3-speed control
- Five slim blades
- Fully assembled and ready to use
- This fan is designed to efficiently circulate airflow to reach desired comfort levels with a three speed-settings feature.
- Rear-mounted controls
- Material: Plastic
- Weight: 6.1 lbs.

Model No. EA527
Price/Each \$62.00



OSCILLATING PEDESTAL FANS

- 3-speed push button front control
- Adjustable height
- Rotating or fixed air direction
- Easy to assemble
- Adjustable tilt



Model No.	Dia."	Wt. lbs.	Price /Each
EA658	16	5.5	52.00
EA551	18	7.3	75.00



OSCILLATING TOWER FANS

- Wide-angle oscillation
- Stable base
- Diameter: 6"
- No. of Speeds: 3
- Colour: Black
- Voltage: 120 V
- Power: 40 W
- Frequency: 60 Hz
- Overall Height: 32"

Model No. EA827
Price/Each \$91.00



20" HIGH VELOCITY PEDESTAL FANS

- 120 V/60 Hz, 1/5 HP, 3-speed motor
- All-metal construction, chrome grill, black painted base
- Adjustable pedestal base
- 6' SJT power cord
- CFM: 5950 high, 4550 medium, 3850 low
- Overall height: 134-157.5 cm
- Base dia.: 48.5 cm
- Stem length: 63-86.5 cm
- Weight: 19.5 lbs.
- Head tilting capability of 360°

Model No. EA289
Price/Each \$263.00



HIGH VELOCITY FLOOR FANS

- 120 V/60 Hz, 1/4 HP, 3-speed motor
- All metal construction



Model No.	Diameter"	High	CFM Med	Low	Finish	Wt. lbs.	Price /Each
EA528	16	2370	1950	1560	Black	6.62	136.00
EA290	18	4725	3850	2975	Chrome	12.8	149.00

EA290



LIGHT INDUSTRIAL-DUTY AIR CIRCULATING FANS

- All-metal construction
- 6' SJT power cord
- Stem length for pedestal: 89-124 cm



Model No.	Description	HP	Voltage	CFM Max.	CFM Min.	No. of Speeds	Price /Each
OSCILLATING							
EA282*	26" Pedestal	1/4	120	7525	4050	3	563.00
EA283*	30" Pedestal	1/3	120	8775	6780	3	600.00
EA284	26" Wall Mount	1/4	120	7525	4050	3	413.00
EA654	30" Wall Mount	1/3	120	8775	6780	3	450.00
NON-OSCILLATING							
EA657*	26" Pedestal	1/4	120	7700	6060	2	585.00
EA571*	30" Pedestal	1/3	120	8000	7000	2	538.00
EA655	26" Wall Mount	1/4	120	7700	6060	2	374.00
EA656	30" Wall Mount	1/3	120	8000	7000	2	406.00

*Features adjustable height and a heavy-duty round base for added stability

OUTDOOR OSCILLATING WALL FANS

- 9' power cord with UL GFCI plug
- Enclosed/waterproof motor type
- All-metal construction
- Chrome grill stand and base painted black
- Motor: 120 V/60 Hz, waterproof
- Drive System: Direct Drive



Model No.	Diameter"	HP	No. of Speeds	High	CFM Medium	Low	Price /Each
EB115	30	1/7	3	7200	5500	3800	720.00

FOLDABLE PEDESTAL FANS

- Fan can be used as a pedestal fan or a floor fan
- Fully assembled fan
- All-metal construction painted black & chrome with aluminum blades
- Equipped with two casters for easy maneuverability
- Motor: 120 V/60 Hz
- Drive System: Direct Drive
- Non-Oscillating



Model No.	Diameter"	HP	No. of Speeds	High	CFM Medium	Low	Price /Each
EB116	24	1/4	3	7000	4500	3500	624.00

LIGHT INDUSTRIAL DIRECT-DRIVE SLIM DRUM FANS

- All-metal construction, painted black & chrome with aluminum blades
- 6' SJT power cord
- 5" casters and easy-moving handle
- Open motor type
- 360° vertical tilt angle
- Motor: 120 V/60 Hz



Model No.	Diameter"	HP	No. of Speeds	High	CFM Medium	Low	Price /Each
EA778	24	3/10	3	7770	6000	4200	294.00
EB114	30	1/3	2	9500	-	6700	565.00

OUTDOOR OSCILLATING PEDESTAL FANS

- Features adjustable height and heavy-duty round base for added stability
- 9.5' power cord with UL GFCI plug
- Enclosed/Waterproof motor type
- All-metal construction, chrome grill stand and base painted black
- Usage Type: Heavy-Duty
- Base Diameter: 27"
- Watts: 220 W



Model No.	Diameter"	HP	No. of Speeds	High	CFM Medium	Low	Price /Each
EA779	30	1/7	3	7200	5470	3780	706.00

OUTDOOR MISTING & OSCILLATING PEDESTAL FANS

- Features a misting hub, adjustable height and heavy-duty round base for added stability
- 9' power cord with UL GFCI plug
- Enclosed/Waterproof motor type (IP44)
- All-metal construction, Misting kit included with direct hose connection, chrome grill stand and base painted black
- Can be used indoor/outdoor
- Usage Type: Heavy-Duty
- Base Diameter: 27"
- Watts: 220 W



Model No.	Diameter"	HP	No. of Speeds	High	CFM Medium	Low	Price /Each
EA829	30	1/7	3	7200	5470	3780	995.00

HEAVY-DUTY INDUSTRIAL AIR CIRCULATING FANS

- 115 V, 1/3 HP, 1 phase, 3 speed, totally enclosed air over ball bearing motor
- Patented modular motor end dome for easy maintenance
- Oscillating and non-oscillating
- Energy efficient - lowest watts per CFM
- Ultra quiet die cast aluminium airfoil propeller
- Wall and I-beam mounts able to be installed by one individual
- Includes: Cord and plug
- Meets OSHA standards



5-YEAR WARRANTY

Airmaster® Fan Company

Model No.	Description	F.L. Amps	High	CFM Med	Low	High	RPM Med	Low	Wt. lbs.	Price /Each
OSCILLATING										
EA353	24" Pedestal	2.5	5387	4356	3125	1070	850	628	89	3325.00
EA355	30" Pedestal	2.6	7996	5859	4063	1045	789	561	95	3489.00
EA354	24" Wall Mount	2.5	5387	4356	3125	1070	850	628	60	3085.00
EA356	30" Wall Mount	2.6	7996	5859	4063	1045	789	561	64	3265.00
NON-OSCILLATING										
EA349	24" Pedestal	2.5	5588	4556	3325	1110	900	700	85	2155.00
EA351	30" Pedestal	2.8	8402	6259	4463	1098	880	660	87	2335.00
EA350	24" Wall Mount	2.5	5588	4556	3325	1110	900	700	56	1925.00
EA352	30" Wall Mount	2.8	8402	6259	4463	1098	880	660	60	2089.00

Note: Performance Ratings are conducted in accordance with AMCA Standard 230-99

HEAVY-DUTY OSCILLATING FANS

PEDESTAL

- All-metal construction, chrome grill and base painted black
- Can be used in oscillating or non-oscillating mode
- Adjustable height and heavy-duty round base for added stability
- 9.8' SJT power cord
- Base Dia. Cm: 69.3
- Open motor type

WALL MOUNTED

- All-metal construction
- Open motor type



MATRIX
INDUSTRIAL PRODUCTS

Model No.	Description	HP	No of Speeds	CFM Max.	Price /Each
EA666	30" Pedestal	1/3	3	13 200	995.00
EA667	30" Wall Mount	1/3	3	13 400	831.00

INDUSTRIAL-DUTY AIR CIRCULATING FANS

- All-metal construction
- 9.8' SJT power cord
- Stem length for pedestal: 89-124 cm
- Pedestal fan models have an open motor and wall mounted models have a fully enclosed motor



MATRIX
INDUSTRIAL PRODUCTS

Model No.	Description	HP	Voltage	CFM Max.	Min.	No. of Speeds	Price /Each
OSCILLATING							
EA645	24" Wall Mount	1/4	120	11 500	7680	2	624.00
EA649	30" Wall Mount	1/4	120	10 780	7760	2	681.00
EA643*	24" Pedestal	1/4	120	11 800	7760	2	725.00
EA647*	30" Pedestal	1/3	120	13 200	6700	2	985.00
NON-OSCILLATING							
EA644	24" Wall Mount	1/4	120	11 500	7680	2	499.00
EA648	30" Wall Mount	1/4	120	10 780	7440	2	556.00
EA642*	24" Pedestal	1/4	120	11 800	7760	2	563.00
EA646*	30" Pedestal	1/4	120	10 780	7440	2	650.00

*Features adjustable height and a heavy-duty round base for added stability

24" ROLL-ABOUT AIR FANS

- 120V, 1/4 HP, 3 speed motor
- 9.8' SJT power cord
- Cart mounted fan for increased air circulation and optimal mobility
- Can be tilted/ positioned to maximise ventilation
- Cart and frame configuration provide stable quiet operation
- CFM: 10760 (high), 7770 (medium), 7040 (low)

Model No. EA476
Price/Each \$494.00



MATRIX
INDUSTRIAL PRODUCTS

MATRIX
INDUSTRIAL PRODUCTS

Maintain the ideal temperature in your workplace

TURBO FANS

- Fan features vertical and horizontal tilt
- Equipped with 6 blades and carrying handle
- Fully assembled and ready to use
- Power: 130 W



Model No.	Diameter"	No. of Speeds	High	CFM Medium	Low	Price /Each
EB117	20	3	2600	2100	1800	154.00

HIGH-VELOCITY OSCILLATING WALL FANS

- Adjustable tilting fan head
- Sliding switch at front of base
- Rotating or fixed air direction
- Voltage: 120 V



Model No.	Diameter"	HP	No. of Speeds	High	CFM Medium	Low	Price /Each
EA660	20	1/5	3	4800	4500	4000	231.00

RECHARGEABLE INDOOR/OUTDOOR FANS WITH USB PORT

- Includes a lithium-ion battery and charger cable
- Power indicator light equipped with 5 LED lights to indicate the battery gauge in every 20%
- Fan can be used in both indoor and outdoor conditions
- Variable speed setting
- USB charging port on the control box can be used to recharge digital devices
- The fan can pivot forwards to a range of 30° and backwards to a range of 90°
- Colour: Yellow
- Voltage: 24 V
- Power: 25 W
- RPM: 1700
- Re-Charge time: 4-5 Hrs
- Duration time at low speed: 24 Hrs
- Duration time at high speed: 4 Hrs
- USB: 5 V, 1 A



Model No.	Diameter"	CFM	Price /Each
EA828	12	1600	405.00

HIGH VELOCITY FLOOR FANS

- All-metal construction
- Vertical pivot fan head
- Copper motor for longer lifetime



Model No.	Diameter"	HP	No. of Speeds	High	CFM Medium	Low	Price /Each
EA661	20	1/5	3	4900	4400	4150	189.00

HEAVY-DUTY FIXED BELT DRIVE DRUM FANS

- Fully enclosed motor
- All-metal construction
- 12' power cord



Model No.	Diameter"	HP	No. of Speeds	High	CFM Low	Price /Each
EA662	42	3/4	2	20945	7400	1645.00

OSCILLATING PEDESTAL FAN

- All-metal construction
- 6.5' SJT power cord
- Features adjustable height and a heavy-duty round base for added stability
- Open motor & direct drive
- Usage Type: Industrial
- Horse Power: 1/16 HP
- Voltage: 120 V
- Frequency: 60 Hz
- Amps: 1.35
- Speed: 1450 RPM



Model No.	Diameter"	HP	No. of Speeds	CFM High	Price /Each
EB239	22	1/16	3	4500	249.00

HIGH VELOCITY FLOOR FAN

- Powerful fan output with 3 speed settings
- Vertical tilt feature and a rotating grill
- Aluminum base
- Voltage: 120 V
- Power Cord Length: 6'
- Speed: 1300 RPM



Model No.	Diameter"	HP	No. of Speeds	Price /Each
EB289	18	2/23	3	160.00

LIGHT INDUSTRIAL DIRECT DRIVE DRUM FANS

- 120 V/60 Hz, 2-speed motor
- All-metal construction, painted black
- 6' SJT power cord
- 6" casters and easy moving handle



Model No.	Blade size"	HP	Watts	CFM		Wt. lbs.	Price /Each
				High	Low		
EA286	28	2/5	290	8050	6650	22	500.00
EA288	36	3/5	405	11200	9100	30.5	630.00

42" BELT DRIVE DRUM FANS

- 115 V, 1 HP, 2-speed, 1-phase, ball bearing motor
- Motor out of air stream – stays clean
- Aluminum 4-bladed propellers
- Rocker switch
- Epoxy coated steel spiral, resilient mount guards
- Steel hubbed wheels, swivel locking casters
- 20-gauge roll form epoxy coated housing
- 10' three-conductor cord and plug
- CFM: 17 100 (high), 9558 (low)
- RPM: 430 (high), 285 (low)
- Quiet operation: 75 dB (high), 67 dB (low)
- Weight: 130 lbs.



Model No. EA319
Price/Each \$1469.00



2-YEAR WARRANTY

DIRECT DRIVE 4-IN-1® DRUM FANS

- 115 V, 1 phase, ball bearing motor
- One fan with four mounting options in the same carton: Hanging mount, ceiling mount, wall mount, portable barrel
- Guards, barrel mountings epoxy coated
- Pull chain switch
- Tilttable



2-YEAR WARRANTY



Model No.	Blade Size"	HP	# of Speeds	CFM			RPM			Wt. lbs.	Price /Each
				High	Med	Low	High	Med	Low		
EA336	30	1/4	3	5670	4590	3410	1110	810	600	97	1369.00
EA337	36	1/2	2	11200	-	8090	830	-	600	119	1635.00

INDUSTRIAL WORKSTATION FANS

- 120 V/60 Hz enclosed motor
- Features 1.8 m power cord with UL/CUL plug
- Locking arm sold separately

180° DOUBLE LOCKING ARM WITH 2 RECEPTACLES

- Moveable arm to accommodate many locations, applications and positions
- Wide range of motion - will not sag when extended
- 2 AC receptacles for easy fan hook-up



EB542



EB540



Model No.	Blade Size"	Blade Material	HP	No. of Speeds	CFM	Price /Each
EB540	12	Aluminum	1/12	3	2600/2400/1600	134.00
EB541	18	Aluminum	1/4	3	3800/3600/2600	223.00
EB542	24	Aluminum	1/3	2	8600/5900	329.00
EB539	180° Double Locking Arm with 2 Receptacles					195.00



EB539

MOBILE 3-IN-1 AIR CONDITIONERS

- 3-in-1 system (A/C, fan, and dehumidifier)
- Features Control panel with LED display on unit with remote control
- Equipped with casters
- 24 hour timer
- Self-evaporative system
- 2 fan and cooling speeds
- Includes: Window kit
- Compact design
- Colour: White
- Voltage: 115 V
- Frequency: 60 Hz
- Coverage: 300 – 350 Sq.Ft. Room



Model No.	BTU Rating	Dimensions				Price /Each	
		W"	x	D"	x		H"
EB118	9000	11-13/16	x	12-5/8	x	24-3/4	861.00

MOBILE 3-IN-1 AIR CONDITIONERS

- 3-in-1 system (A/C, fan, and dehumidifier)
- Features Control panel with LED display on unit with remote control
- Equipped with casters
- 24 hour timer
- Self-evaporative system
- 3 fan and cooling speeds
- Includes: Window kit
- Compact design
- Colour: White
- Voltage: 115 V
- Frequency: 60 Hz
- Coverage: 350 Sq.Ft Room



Model No.	BTU Rating	Dimensions				Price /Each	
		W"	x	D"	x		H"
EA830	12000	17-13/15	x	14-13/15	x	27-9/16	1100.00

DEHUMIDIFIERS

- Water bucket full indicator
- Omni-directional casters
- 24-hour timer
- 3 L tank capacity
- Auto restart function and auto defrosting
- Energy-Star Certified
- Washable filter
- LED display



Model No.	Capacity Pints	Coverage sq.ft.	Price /Each
EA831	50	4000	884.00

ELECTRONIC WINDOW HORIZONTAL AIR CONDITIONERS

- Cools up to 350 square feet
- 3 fan speeds
- Washable filter
- Remote control included
- Fits a 14" x 23-36" window opening
- Includes: Window filler panel, Mounting hardware
- Amps: 15 A
- Voltage: 115 V
- Energy Star Certification: EER 12.0



Model No.	BTU Rating	Dimensions				Price /Each	
		W"	x	D"	x		H"
EB119	8000	18-1/2	x	15-11/16	x	13-3/8	711.00

AIR CURTAIN WITH REMOTE CONTROL

- Maintains indoor air quality and saves energy by minimizing air loss through open doorways
- Prevents dust, odours, fumes, and insects, from entering indoors through powerful air flow
- Airflow directed by oscillating louvers
- Mount on the interior of doors, windows, or walls
- Features a 5' long power cord with grounded NEMA 5-15 plug
- No. of Speeds: 2
- Voltage: 120V
- Maximum Door Height: 10'
- Phase: 1
- Decibels: 56
- Hertz: 60



Model No.	CFM		Dimensions				Price /Each	
	Low	High	W"	x	D"	x		H"
EB290	670	815	36	x	8-1/2	x	8-5/8	380.00
EB291	816	990	48	x	8-1/2	x	8-5/8	455.00

HORIZONTAL AIR CONDITIONER

- Fits a 14" x 23-36" window opening
- Energy Star Certification: EER 12.0
- For 450 to 550 sq.ft rooms
- Remote control included
- Washable filter
- 3 fan speeds
- Type: Window
- Voltage: 115 V
- Amps: 15 A
- Includes: Window filler panel, Mounting hardware



Model No.	BTU Rating	Dimensions				Price /Each	
		W"	x	D"	x		H"
EB236	12000	19	x	14-3/5	x	21-2/5	986.00

PORTABLE FAN-FORCED UTILITY HEATERS

- Two heat settings (1300 W and 1500 W) provide full comfort and economic operation
- Adjustable thermostat
- Fan-only setting
- Tip over safety switch
- Built-in carrying handle with front safety guards



Model No.	Volts	Watts	BTU/H	Amps	Price /Each
EA598	120	1300/1500	4435/5120	10.8/12.5	68.90

PORTABLE OPEN COIL HEATERS

- Two heat settings (1500 W and 1000 W)
- Provide full comfort and efficient operation
- Fully adjustable automatic thermostat
- Safety overload switch
- Power signal light
- Top mounted handle and controls
- Grounded plug and controls



Model No.	Volts	BTU/H	Watts	Amps	Price /Each
EA469	120	3410/5120	1000/1500	8.3/12.5	94.90

PORTABLE FAN-FORCED CONVECTION HEATERS

- Two heat settings (1500W and 750W) provide full comfort and efficient operation
- Adjustable thermostat
- Wide-angle oscillation
- Tip over safety switch and thermal limit control



Model No.	Volts	Watts	BTU/H	Amps	Price /Each
EA597	120	750/1500	2560/5200	6.25/12.5	55.90

PORTABLE FAN-FORCED/RADIANT UTILITY HEATERS

- Three heat settings provides full comfort and efficient operation
- 600 W radiant
- 900 W fan forced
- 1500 W fan forced and radiant
- Chrome-plated safety grill
- Automatic built-in thermostat
- Ceramic core element
- Tip over safety switch and thermal limit



Model No.	Volts	Watts	BTU/H	Amps	Price /Each
EA466	120	600/900/1500	2048/3072/5120	5.07/5/12.5	168.00

PORTABLE CERAMIC HEATERS

- Two heat settings (1500 W and 750 W) provide full comfort and efficient operation
- Adjustable thermostat
- PTC heating element
- Tip over safety switch and thermal safety fuse



Model No.	Volts	Watts	BTU/H	Amps	Price /Each
EA599	120	750/1500	2560/5200	6.25/12.5	74.10

OIL-FILLED HEATERS

- 7-fin, oil-filled heater
- Three heat settings provide full comfort and efficient operation
- Adjustable thermostat
- Built-in over heating protection



Model No.	Volts	Watts	BTU/H	Amps	Price /Each
EA612	120	600/900/1500	5120	12.5	115.00

OSCILLATING CERAMIC HEATERS

- Built-in over heating protection, tip over switch and power indicator light
- Adjustable thermostat
- 2 heat settings (750 W and 1500 W) provide maximum comfort
- Includes fan only setting
- Equipped with an oscillation feature
- Power Cord Length: 6'
- Dimensions: 6.8" W x 5.1" D x 10.8" H



Model No.	Volts	Watts	BTU/H	Amps	Price /Each
EB467	120	750/1500	2600/5200	6.25/12.5	88.40

OSCILLATING CERAMIC TOWER HEATERS

- Built-in over heating protection, tip over switch and power indicator light
- Adjustable thermostat
- 2 heat settings (750 W and 1500 W) provide maximum comfort
- Includes fan only setting
- Equipped with an oscillation feature
- Power Cord Length: 6'
- Dimensions: 7.4" W x 6.9" D x 18.5" H



Model No.	Volts	Watts	Max. BTU/H	Amps	Price /Each
EB020	120	750/1500	5200	6.25/12.5	103.00

CONTRACTOR HEATERS

- Built-in thermostat
- Safety high temperature limit
- Steel spiral fin brazed to metal sheath elements for maximum heat transfer
- 6' heavy-duty cord
- Built-in handle/cord storage
- Permanently lubricated motor



Model No.	Volts	PH	Watts	BTU/H	Amps	Plug Type	Wt. lbs.	Price /Each
EA477	240	1	5600	19 100	23.34	#6-30P	12	298.00
EB100	240	1	4800	16 380	20	#6-30P	12	220.00

PORTABLE CERAMIC HEATERS

- Two heat settings (1500 W and 900 W) provide full comfort and efficient operation
- Adjustable thermostat
- Big carry handle



Model No.	Volts	Watts	BTU/H	Price /Each
EA650	120	900/1500	2560/5200	130.00

PORTABLE HEATER

- Two heat settings (1500 W and 750 W) provide full comfort and efficient operation
- Adjustable thermostat
- Tip over safety switch and thermal safety fuse



Model No.	Mfg. No.	Type	Min BTU Rating	Max BTU Rating	Min Wattage	Max Wattage	Price /Each
EB182	FH125	Ceramic	2557 BTU/H	5115 BTU/H	750 W	1500 W	71.50
EB183	MK-1	Fan	2557 BTU/H	5115 BTU/H	750 W	1500 W	120.00

HEAVY-DUTY TILTED HEATERS

- Industrial finger proof steel intake/discharge grills
- Durable metal construction with enclosed motor
- One-speed fan only function
- Built-in over heating protection
- Air flow direction adjustable from 10°-50°
- Adjustable thermostat
- Energy-saving
- Convenient carrying handle
- Forced-air heater function
- Safety shutoff function
- Power Cord Length: 6'
- Max. Temperature: 100°F



Model No.	Volts	Watts	BTU/H	Amps	Price /Each
EB021	240	5600	19 107	23.3	337.00

PORTABLE INFRARED HEATER

- Provides instant sun-like heat that directly warms objects
- Adjustable thermostat
- Cool touch flame-resistant plastic housing
- Overheat and tip over shut-off
- Type: Radiant Heat
- Min BTU Rating: 2560 BTU/H
- Max BTU Rating: 5120 BTU/H
- Overall Dimensions: 23" H x 13" W x 9.3" D
- Amperage: 12.5 A
- Wattage: 750W/1500W
- Voltage: 120 V



Model No. EB184
Mfg. No. TQH-06
Price/Each \$135.00



PATIO HEATER

- High efficiency infrared heating
- IP65 rated for outdoor use
- Remote and pull-string control
- Two LED lights



Model No.	Type	Watts	BTU/H	Price /Each
EB307	Wall	500/1000/1500	1705/3410/5115	399.00

HEAVY-DUTY CEILING MOUNT HEATERS

- Multi wattage covering 3000-5000 W (3000 W, 4000 W, 5000 W)
- Rugged heavy-duty industrial heater
- Ideal for use in storage rooms, workshops, garages, warehousing
- Built-in ceiling bracket for easy mounting
- Automatic fan delay
- Dimensions: 10-5/8" W x 12-1/2" D x 14" H



Model No.	Volts	BTU/H Min./Max.	Price /Each
EA532	240	8530/17 060	306.00
EA652	240	8530/25 600	519.00

360 DEGREE SURROUND PORTABLE HEATER

- Features 360 degree outlet air, PTC heating elements, adjustable thermostat, tip-over switch, overheat protection, and carry handle
- Features 2 heat settings (750 W & 1500 W) and a fan-only setting
- Type: Ceramic
- Max BTU Rating: 5200 BTU/H
- Voltage: 120 V
- Amperage: 12.5 A
- Power Cord Length: 6'
- Plug Type: Standard

Model No. EB480
Price/Each \$67.55



PERSONAL METAL SHOP HEATER WITH THERMOSTAT

- Features 3 settings for fan-only, high heat, and low heat
- Automatic overheat protection
- Durable sturdy steel cabinet
- Easy carry handle
- Type: Fan
- Certifications: cETL
- Power: 750 W & 1500 W
- Voltage: 120 V
- Heat Coverage: 800-1000 sq.ft.
- Power Cord Length: 6'
- Plug Type: Standard

Model No. EB479
Price/Each \$53.55



PORTABLE SALAMANDER HEATERS

- Manufactured for long lasting, this portable heater for warehouses, factories, garages, construction sites, pavilions and other open areas, raise temperature to the desired level gradually for worksite comfort
- Adjustable thermostat
- Adjustable tilt angle
- Mounted on 10" solid rubber wheels
- Over heat protection
- Easy to move to different areas of the site
- Variable speed setting, fan forced
- Type: Contractor
- Fan Motor Type: Enclosed air over, Ball bearing
- Colour: Orange with Black Cart



TANK-TOP HEATERS

- Efficient, heats radiantly, directly, no loss of heat to the air
- Economical, no electricity required
- Ready to use: mounts directly to a 20-lb. cylinder (not included)
- Variable BTU's
- Safe: Heater shuts off automatically with loss of flame
- Adjustable heat control: high, medium, low regulator
- **Model EA292:** Operate one or two burners at a time
- For outdoor use only



Model No.	Volts	Watts	BTU/H	Price /Each
EA786	240	10 080	34 121	1625.00

Model No.	Mfg. No.	Description	BTU/H	Price /Each
EA291	F242100	Single	8, 12 and 15 000 BTU/H	109.00
EA292	F242650	Double	8, 12, 15, 16, 24 and 30 000 BTU/H	229.00

TRADESMAN® FORCED AIR PROPANE HEATERS

- Tradesman® forced air heaters feature a unique 3-trial ignition system, the industry's heaviest gauge combustion chamber and burner plate
- Variable output control for maximized fuel efficiency
- Electronic spark ignition
- Thermostatic temperature control
- Tri-Shield finish provides protection against abrasion and corrosion
- Adjustable front leg provides easy direction of heat
- 15' hose
- Voltage: 115 V



JG953



JG954

Model No.	Mfg. No.	Amperage (Starting/Continuous Operation)	Wattage (Starting/Continuous Operation)	BTU Rating	Price /Each
JG953	TRADESMAN 170	3.7/2.4	425.5/241.5	125 000 to 170 000	975.00
JG954	TRADESMAN 400	4.0/1.3	460/172.5	250 000 to 400 000	1579.00

TRADESMAN® FORCED AIR KEROSENE HEATER

- Tradesman® kerosene heaters provide instant, efficient, directional heat
- A dependable dual-prong electronic spark ignition, heavy-duty enclosed motor and long lasting composite fuel fittings are just a few of the features that provide long life and trouble free operation
- Dual-prong electronic spark ignition
- Auxiliary 110 V power receptacle
- Temperature display and thermostat
- Fuel gauge indicates remaining run time
- Threaded drain plug
- Wheels and handles make it easier to maneuver (except JG957)
- Includes pressure gauge (except JG957)
- Voltage: 115 V



Model No.	Mfg. No.	Amperage (Continuous Operation)	Wattage (Continuous Operation)	BTU Rating	Tank Capacity US Gallons	Price /Each
JG957	TRADESMAN K75	1.6	184	75 000	5	739.00
JG958	TRADESMAN K125	2.5	287.5	125 000	10	1065.00
JG959	TRADESMAN K175	3.2	368	175 000	13	1165.00
JG960	TRADESMAN K210	3.7	425.5	210 000	13	1395.00
JG962	TRADESMAN K650	7.1	816.5	650 000	50	6219.00

SUN BLAST® FLAT PANEL RADIANT HEATERS

- Sun Blast® flat panel is great for spot heating large areas
- Folding handle and wheels for easy transport
- Piezo pilot ignition
- Tip over switch shuts product down for safety
- Works with standard 20 lb. cylinder
- Lightweight for easy maneuverability
- Directional heating
- Natural gas version also available



SUN BLAST® ROUND RADIANT HEATER

- Sun Blast® round provides 360° radiant heating
- High handle and wheels for easy transport
- Durable rugged construction ideal for any construction site
- Piezo pilot ignition
- Tip over switch shuts product down for safety
- Natural gas version also available



Model No.	Mfg. No.	Rating BTU/H	Price /Each
JG968	SUN BLAST 35	35 000	445.00



Model No.	Mfg. No.	Rating BTU/H	Price /Each
JG969	SUN BLAST 125	125 000	755.00

SHUTTER FANS

- 115 V motor 1 phase
- Totally enclosed motor
- Direct drive, low pressure
- Fully assembled, ready to install
- Rear guard meets OSHA standards
- 24" and 30" : 3 speeds with pull chain motor, plug and cord included

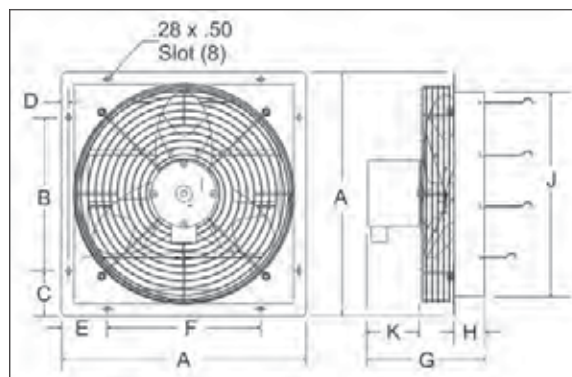

Model No.	Fan Dia. "	CV	0" S.P. CFM	1/8" S.P. CFM	A"	B"	F"	Dimensions			Panel Size (square)	Wall Opening (square)	Weight lbs.	Price /Each	
					G"	H"	J"	K"							
EA368	7	1/30	121	60	11.1	4	4	8.06	2.38	8	3	11 1/8"	8 1/2"	10	435.00
EA369	10	1/30	611	318	13.1	6	6	8.06	2.38	10	3	13 1/8"	10 1/2"	10	469.00
EA370	12	1/30	815	490	15.1	8	8	8.06	2.38	12	3	15 1/8"	13"	12	579.00
EA371	16	1/20	1216	765	19.1	12	12	9.06	2.38	16	4	19 1/8"	17"	20	809.00
EA372	18	1/15	1877	752	21.1	14	14	11	2.5	18	4.8	21 1/8"	18 1/2"	25	855.00
EA373	20	1/15	2235	920	23.1	16	16	11	2.5	20	4.8	23 1/8"	20 1/2"	35	1079.00
EA374	24	1/4	3214	2015	27.1	20	20	12.7	3	24	5	27 1/8"	25"	48	1569.00
EA375	30	1/4	4970	3510	33.1	26	26	12.7	3	30	5	33 1/8"	30 1/2"	57	1245.00

ALL PURPOSE WALL FANS

- 115 V motor
- Direct drive, low pressure
- Totally enclosed sleeve bearing motors
- Non-overloading propeller
- High efficiency, low operating cost
- Built-in rear guard
- Commercial-duty
- Four holes 0.38" dia.

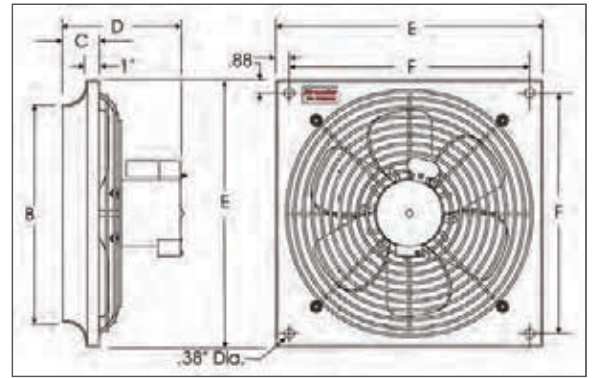

 **Airmaster® Fan Company**

Model No.	Fan Dia."	HP	RPM	Capacity (CFM) @ SP In. W.G.					Dimensions				Weight lbs.	Price /Each			
				0"	0.05"	0.10"	0.125"	0.20"	0.250"	A"	B"	C"			D"	E"	F"
EA376	10	1/30	1550	630	469	418	394	309	234	10	10 1/4	1 1/2	6	14	12.3	12	575.00
EA377	12	1/30	1550	897	843	754	689	503	378	12	12 1/4	1 1/2	8	16	14.3	14	615.00
EA378	16	1/9	1050	1881	1766	1626	1540	1169	814	16	16 1/2	1 3/4	9 1/2	20	18.3	24	835.00
EA379	18	1/9	1050	2504	2345	2149	2035	1553	884	18	18 1/2	1 3/4	10	22	20.3	27	975.00

8" AIR BLOWER

- Lightweight, portable design
- Single-speed motor with thermal protection
- Type: Axial
- Horse Power: 1/4
- Free Air Flow Rate: 816 CFM
- Housing Material: Plastic
- Colour: Blue



Model No.	Description	Price /Each
EB534	8" Air Blower	453.00
EB537	8" Air Blower with 15' Ducting & Canister	759.00
EB538	8" Air Blower with 25' Ducting & Canister	808.00
EB535	15' Ducting with Canister	265.00
EB536	25' Ducting with Canister	331.00

TAKING THE STRESS OUT OF SPILLS



30/30® HIGH-CAPACITY PLEATED PANEL FILTERS

Features and benefits:

- High capacity pleated panel filter available in 1", 2" or 4" depths
- A welded wire grid to maintain the radial pleat and eliminates distortion of the media pack even under turbulent or high airflow conditions
- Exclusive MERV 8 Media, blended from cotton and polyester fibres, providing consistent dirt removal efficiency throughout the life of the filter
- The 30/30 meets today's medical facility requirements
- A low initial and maintained low resistance to airflow, over the life of the filter that saves energy dollars
- A high wet-strength beverage board frame for maintained filter rigidity in any application
- Maximum continuous operating temperature of 200°F (93°C)
- Proprietary blend of cotton and synthetic fibres in a uniform lofted media blanket

Efficiency: Value of 8 for MERV and MERV-A when evaluated under ASHRAE Testing Standard 52.2.

Typical applications: Pre-filters to higher efficiency filters, stand-alone filter for rooftops, split systems, free-standing units and package systems and air handlers. Ideal for commercial, industrial, institutional or any other application where the ultimate level of protection of equipment and indoor air quality is a concern.



Model No.	Nominal Size					Actual Size					CFM		Resistance*		Media Area sq.ft.	Pleats /foot	Price /Each
	W"	x	D"	x	H"	W"	x	D"	x	H"	Medium	High	Medium	High			
EA157	16	x	4	x	20	15.38	x	3.75	x	19.38	550	1100	0.07	0.27	15.7	11	31.90
EA158	20	x	4	x	20	19.38	x	3.75	x	19.38	695	1390	0.07	0.27	18.9	11	33.90
EA159	12	x	4	x	24	11.38	x	3.75	x	23.38	500	1000	0.07	0.27	13.9	11	27.90
EA160	24	x	4	x	24	23.38	x	3.75	x	23.38	1000	2000	0.07	0.27	27.7	11	45.50
EA161	16	x	4	x	25	15.38	x	3.75	x	24.38	695	1390	0.07	0.27	19.7	11	38.50
EA162	20	x	4	x	25	19.38	x	3.75	x	24.38	870	1740	0.07	0.27	23.6	11	40.90
EA163	16	x	2	x	20	15.5	x	1.75	x	19.5	550	1100	0.08	0.28	9.9	15	18.50
EA164	20	x	2	x	20	19.5	x	1.75	x	19.5	695	1390	0.08	0.28	11.9	15	19.90
EA165	12	x	2	x	24	11.38	x	1.75	x	23.38	500	1000	0.08	0.28	8.4	15	16.50
EA166	24	x	2	x	24	23.38	x	1.75	x	23.38	1000	2000	0.08	0.28	17.3	15	26.50
EA167	16	x	2	x	25	15.5	x	1.75	x	24.5	695	1390	0.08	0.28	12.4	15	20.50
EA168	20	x	2	x	25	19.5	x	1.75	x	24.5	870	1740	0.08	0.28	14.9	15	22.50
EA169	12	x	1	x	24	11.5	x	0.88	x	23.5	350	700	0.11	0.25	4.9	16	15.50
EA170	16	x	1	x	20	15.5	x	0.88	x	19.5	390	780	0.11	0.25	5.4	16	13.50
EA171	20	x	1	x	20	19.5	x	0.88	x	19.5	485	970	0.11	0.25	6.6	16	15.50
EA172	24	x	1	x	24	23.5	x	0.88	x	23.5	700	1400	0.11	0.25	9.8	16	19.90
EA173	16	x	1	x	25	15.5	x	0.88	x	24.5	485	970	0.11	0.25	6.7	16	13.90
EA174	20	x	1	x	25	19.5	x	0.88	x	24.5	610	1220	0.11	0.25	8.3	16	18.50

*Initial resistance to airflow (inches w.g.)

Other sizes also available.

AEROPLEAT® III STANDARD CAPACITY PLEATED PANEL FILTERS

Features and benefits:

- Medium capacity pleated panel filter
- Optimum blend of cotton and synthetic fibres provides medium grade ASHRAE performance and increased dust-holding capacity
- Welded wire media grid is treated for corrosion resistance and prevents media oscillation or pull-away
- High wet-strength beverage board frame creates a rigid and durable filter pack
- Efficiency MERV 8 when evaluated per ASHRAE Standard 52.2-2007 and a MERV-A of 8 when evaluated under Appendix J of that Standard
- Applications include commercial buildings, educational facilities and specialty manufacturing
- As a pre-filter the Aeropleat III offers protection for the higher efficiency final filters required for today's high technology applications



Model No.	Nominal Size					Actual Size					CFM		Resistance*		Media Area sq.ft.	Pleats /foot	Price /Each
	W"	x	D"	x	H"	W"	x	D"	x	H"	Medium	High	Medium	High			
EA139	16	x	4	x	20	15.38	x	3.75	x	19.38	555	1110	0.07	0.21	12.6	9	23.50
EA140	20	x	4	x	20	19.38	x	3.75	x	19.38	695	1390	0.07	0.21	15.7	9	25.50
EA141	12	x	4	x	24	11.38	x	3.75	x	23.38	500	1000	0.07	0.21	11.3	9	19.50
EA142	24	x	4	x	24	23.38	x	3.75	x	23.38	1000	2000	0.07	0.21	22.7	9	31.90
EA143	16	x	4	x	25	15.38	x	3.75	x	24.38	695	1390	0.07	0.21	15.7	9	26.90
EA144	20	x	4	x	25	19.38	x	3.75	x	24.38	870	1740	0.07	0.21	19.7	9	28.90
EA145	16	x	2	x	20	15.5	x	1.75	x	19.5	555	1110	0.08	0.23	6.5	10	12.50
EA146	20	x	2	x	20	19.5	x	1.75	x	19.5	695	1390	0.08	0.23	8.6	10	15.50
EA147	12	x	2	x	24	11.38	x	1.75	x	23.38	500	1000	0.08	0.23	6.1	10	11.50
EA148	24	x	2	x	24	23.38	x	1.75	x	23.38	1000	2000	0.08	0.23	12.1	10	16.50
EA149	16	x	2	x	25	15.5	x	1.75	x	24.5	695	1390	0.08	0.23	7.8	10	15.50
EA150	20	x	2	x	25	19.5	x	1.75	x	24.5	870	1740	0.08	0.23	10.7	10	16.50
EA151	12	x	1	x	24	11.5	x	0.88	x	23.5	350	700	0.11	0.23	3.8	12	15.50
EA152	16	x	1	x	20	15.5	x	0.88	x	19.5	390	780	0.11	0.23	4.3	12	12.90
EA153	20	x	1	x	20	19.5	x	0.88	x	19.5	485	970	0.11	0.23	5.4	12	13.90
EA154	24	x	1	x	24	23.5	x	0.88	x	23.5	700	1400	0.11	0.23	7.8	12	19.90
EA155	16	x	1	x	25	15.5	x	0.88	x	24.5	485	970	0.11	0.23	5.4	12	16.50
EA156	20	x	1	x	25	19.5	x	0.88	x	24.5	610	1220	0.11	0.23	6.7	12	15.50

*Initial resistance to airflow (inches w.g.)

Other sizes also available.

FLUORESCENT TUBES

FLUORESCENT LAMPS

SYLVANIA



XB186



XB168

Nominal Watts	Lamp	Nominal length"	Base	Model No.	Mfg. No.	Qty /Case	Description	Light output approx. initial lumens	Price /Case
T5									
14	T5	24	Mini Bi-Pin	XG943	FP14/835/ECO	40	3500 K, 85 CRI, Pentron® Ecologic	1200	559.00
14	T5	24	Mini Bi-Pin	XG944	FP14/841/ECO	40	4100 K, 85 CRI, PPentron® Ecologic	1200	559.00
24	T5	24	Mini Bi-Pin	XG945	FP24/841/HO/ECO	40	4100 K, 85 CRI, Pentron® Ecologic	1750	759.00
28	T5	48	Mini Bi-Pin	XG946	FP28/835/ECO	40	3500 K, 85 CRI, Pentron® Ecologic	2600	669.00
28	T5	48	Mini Bi-Pin	XG947	FP28/841/ECO	40	4100 K, 85 CRI, Pentron® Ecologic	2600	669.00
54	T5	48	Mini Bi-Pin	XG948	FP54/830/HO/ECO	40	3000 K, 85 CRI, Pentron® Ecologic	4450	459.00
54	T5	48	Mini Bi-Pin	XG949	FP54/835/HO/ECO	40	3500 K, 85 CRI, Pentron® Ecologic	4450	509.00
54	T5	48	Mini Bi-Pin	XG950	FP54/841/HO/ECO	40	4100 K, 85 CRI, Pentron® Ecologic	4450	509.00
54	T5	48	Mini Bi-Pin	XG951	FP54/850/HO/ECO	40	5000 K, 85 CRI, Pentron® Ecologic	4310	499.00
54	T5	48	Mini Bi-Pin	XG952	FP54/865/HO/ECO	40	6500 K, 85 CRI, Pentron® Ecologic	4100	509.00
T8									
15	T8	18	Medium Bi-Pin	XB160	F15T8/D	24	Daylight	750	109.00
15	T8	18	Medium Bi-Pin	XA572	F15T8/CW	24	Cool white	825	125.00
17	T8	24	Medium Bi-Pin	XB177	F017/841/XP/ECO	30	4100 K, 75 CRI, Octron® 700 XP, Eco.	1325	239.00
17	T8	24	Medium Bi-Pin	XG933	F017/835/ECO	30	3500 K, 82 CRI, Octron® 800 Ecologic	1350	209.00
25	T8	36	Medium Bi-Pin	XB178	F025/830/XP/ECO	30	3000 K, 75 CRI, Octron® 700 XP, Eco.	2050	309.00
25	T8	36	Medium Bi-Pin	XG934	F025/841/XP/ECO3	30	4100 K, 85 CRI, Octron® 800 XP Ecologic	2175	339.00
25	T8	48	Medium Bi-Pin	XG938	F032/25 W/841/XP/SS/ECO3	30	4100 K, 85 CRI, Octron® 800 XP Supersaver Ecologic	2500	369.00
28	T8	48	Medium Bi-Pin	XG936	F028/850XP/XL/SS/ECO3	30	5000 K, 81 CRI, Octron® XP Supersaver Ecologic	2600	345.00
28	T8	48	Medium Bi-Pin	XG960	F028/841/XV/SS/ECO	30	4100 K, 83 CRI, Octron® 800 XV Supersaver Ecologic	2600	369.00
28	T8	48	Medium Bi-Pin	XG968	F028/835/XV/SS/ECO	30	3500 K, 83 CRI, Octron® 800 XV Supersaver Ecologic	2600	355.00
28	T8	48	Medium Bi-Pin	XG935	F028/841/XP/SS/ECO3	30	4100 K, 85 CRI, Octron® 800 XP Supersaver Ecologic	2725	309.00
32	T8	48	Medium Bi-Pin	XG964	F032/V41/ECO	30	4100 K, 90 CRI, Octron® Vivid Value Ecologic	2450	209.00
32	T8	48	Medium Bi-Pin	XG745	F032/V50/ECO	30	5000 K, 75 CRI, Octron® 700, Eco.	2250	255.00
32	T8	48	Medium Bi-Pin	XG940	F032/865/XP/ECO	30	6500 K, 85 CRI, Octron® 800 XP Ecologic	2900	249.00
32	T8	48	Medium Bi-Pin	XG526	F032/835/ECO	30	3500 K, 85 CRI, Octron® 800, Eco.	2950	251.70
32	T8	48	Medium Bi-Pin	XB917	F032/841/ECO	30	4100 K, 75 CRI, Octron® 800, Eco.	2950	259.00
32	T8	48	Medium Bi-Pin	XG961	F032/841/XP/XL/ECO3	30	4100 K, 85 CRI, Octron® XP XL Ecologic	2950	359.00
32	T8	48	Medium Bi-Pin	XG973	F032/835/XP/ECO3	30	3500 K, 85 CRI, Octron® 800 XP Ecologic	3000	229.00
32	T8	48	Medium Bi-Pin	XG969	F032/835/XPS/ECO3	30	3500 K, 85 CRI, Octron® 800 XPS Ecologic	3100	345.00
32	T8	48	Medium Bi-Pin	XG965	F032/850/XP/ECO3	30	5000 K, 85 CRI, Octron® 800 XP Ecologic	3000	249.00
32	T8	48	Medium Bi-Pin	XG939	F032/841/XP/ECO3	30	4100 K, 85 CRI, Octron® 800 XP Ecologic	3000	249.00
40	T8	60	Medium Bi-Pin	XG941	F040/841/XP/ECO3	30	4100 K, 85 CRI, Octron® 800 XP Ecologic	3750	485.00
59	T8	96	Medium Bi-Pin	XG942	F096/841/ECO	24	4100 K, 82 CRI, Octron® 800 XV Supersaver Ecologic	5900	705.00
T12									
20	T12	24	Medium Bi-Pin	XB162	F20T12/D	30	Daylight	1075	395.00
30	T12	36	Medium Bi-Pin	XB163	F30T12/CW/RS	30	Cool white rapid start	2200	435.00
30	T12	36	Medium Bi-Pin	XG971	F30T12/VW/RS	30	3000 K, 52 CRI, Standard	2275	349.00
40	T12	48	Medium Bi-Pin	XB165	F40DX	30	Daylight deluxe	2180	295.00
60	T12	96	Single Pin	XE660	F96T2/CW/XS/SOPC	15	Cool white	3850	435.00
75	T12	96	Single Pin	XB168	F96T12/DX	15	Daylight deluxe	4360	465.00
75	T12	96	Single Pin	XG930	F96T12/CWX	15	4100 K, 87 CRI, Slimline	4400	445.00
U-BENT									
31	T8	22.5	Medium Bi-Pin	XG991	FB031/841	15	4100 K, 82 CRI, Octron® 800 Curvalume®	2725	505.00
32	T8	22.5	Medium Bi-Pin	XB186	FB032/841/6/ECO	16	4100 K 82 CRI, Octron® 800	2850	392.00
32	T8	22.5	Medium Bi-Pin	XG932	FB032/835/6/ECO	16	3500 K, 82 CRI, Curvalume®	2850	399.00
32	T8	22.5	Medium Bi-Pin	XB187	FB032/830/6/ECO	16	3000 K, 82 CRI, Octron® 800	2850	689.00
40	T12	22.5	Medium Bi-Pin	XG931	FB40/CWX/6	12	4100 K, 87 CRI, Curvalume® Rapid Start	2100	525.00
HIGH OUTPUT									
60	T12	48	Recessed Double Contact	XG928	F48T12/CW/HO	30	4200 K, 60 CRI, High Output	4050	719.00
85	T12	72	Recessed Double Contact	XG929	F72T12/CW/HO	15	4200 K, 60 CRI, High Output	6250	445.00
110	T12	96	Recessed D.C.	XB188	F96T12/CW/HO/COLDTEMP	15	Coolhite intended for cold temperature applications only	8600	485.00
110	T12	96	Recessed D.C.	XB190	F96T12/D/HO/COLDTEMP	15	Daylight intended for cold temperature applications only	7600	489.00

EXIT SIGNS

- New easy click design allows for fast installation
- Single face or double face orientation
- Various mounting orientation (wall, side, ceiling)
- Ideal for use in offices, schools and warehouses

XI788



XI789



Model No.	Description	Price /Each
XI788	Ni-Cd 3.6V 1000 mAh Battery	89.00
XI789	Lead-Acid Battery (6 V 6 Ah), with Lights	179.00

STELLA RUNNING MAN EXIT SIGNS

- Feature 120/347 VAC dual input (hardwire), universal DC; 6-24 VDC or self-powered
- Running Man sign uses a 2 watt LED source
- Long life LED light source
- Universal pictograms included showing left indicators, right indicators and no indicators
- 20-gauge steel construction with white baked powder coat paint finish
- Pre-stamped universal mounting and keyhole slots on backplate



XE662



Model No. XE662
Mfg. No. SL-RM-SP-L-U-0LR-M (Self-powered)
Price/Each \$177.00

Model No. XE663
Mfg. No. SL-RM-L-U-0LR-M-UDC (6-24 VDC)
Price/Each \$155.00



STELLA EXIT SIGNS

- C860 approved
- Standard 120/347VAC input (hardwire) and sealed nickel-cadmium batteries provide a minimum of 30 minutes of emergency duration
- Uses 2 W LED board
- Long life LED light source
- Knockout chevrons
- 20-gauge steel construction with baked powder coat white paint finish
- Pre-stamped universal mounting and keyhole slots on backplate

XB930



XB933



Model No.	Mfg. No.	Description	Dimensions W" x D" x H"	Price /Each
XB930	SLE-SP-L-R-U-M	Exit	12 x 2.25 x 7.5	169.00
XB933	SLS-L-R-U-M-UDC	Sortie	18.5 x 2.25 x 7.5	199.00

RUNNING MAN SIGN WITH SECURITY LIGHTS

- New easy click design allows for fast installation
- Single face or double face orientation
- Various mounting orientation (wall, side, ceiling)
- Ideal for use in offices, schools and warehouses
- 2 hours of emergency light duration
- Lead-acid battery (6 V 6 Ah)

Model No. XI790
Price/Each \$179.00



STELLA RUNNING MAN COMBO EXIT SIGNS

- Running Man models are supplied with 120/347 VAC dual input (hardwire)
- Push button test switch
- Self-powered for minimum 30 minutes – 6V DC 36W
- Solid state transfer charger
- Dual diagnostic LEDs indicate AC-ON and CHARGE
- Brownout and low voltage protection
- Two top mounted high impact thermoplastic PAR18 5-Watt tungsten heads
- Universal pictograms included showing left indicators, right indicators and no indicators
- 20-gauge steel construction with white baked powder coat paint finish
- Certified for sale in Canada by an accredited certification body



Model No. XE664
Mfg. No. SL-RM-6-36-L-U-0LR-M-2SR/9W
Price/Each \$329.00

STELLA COMBINATION SIGNS

- C860 approved
- LED EXIT and SORTIE models 120/277/347 VAC dual input (hard wire)
- Push button test switch
- Self-powered for minimum 30 minutes -6 VDC 36 W
- Solid state transfer charger
- Dual diagnostic LEDs indicate AC-ON and CHARGE
- Brownout and low voltage protection
- Two top mounted high impact thermoplastic PAR18 9 W tungsten heads
- Knockout chevrons
- 20-gauge steel construction with baked powder coat white paint finish



Model No.	Mfg. No.	Description	Price /Each
XB929	SLE-6-36-L-R-U-M-2SR/9W	Exit	389.00
XB932	SLS-6-36-L-R-U-M-2SR/9W	Sortie	480.00
REPLACEMENT BULB			
XB338	LP104	9 W Tungsten	6.25

EMERGENCY LIGHTING

NOVA EMERGENCY LIGHTING UNITS

- 120/277/347 VAC input
- Push button test switch
- Dual diagnostic LEDs indicate AC-ON and CHARGE
- Solid state transfer charger
- Brownout and low voltage protection
- Two top mounted high impact thermoplastic PAR18 9 W tungsten heads
- 20-gauge steel construction with baked powder coat white paint finish
- Pre-stamped universal mounting and keyhole slots
- Output 6 VDC or 12 VDC at rated wattage for 30 minutes
- Batteries included



XA440



XA439



XA190



Model No.	Mfg. No.	Replacement Batteries	Voltage Output	Watts Output				Price /Each
				1/2 hr.	1 hr.	1 1/2 hr.	2 hr.	
XA190	NV-636/2SR	XA604	6	36	18	12	9	221.00
XA438	NV-650/2SR	XB921	6	50	25	17	12	249.00
XA439	NV-680/2SR	XA605	6	80	40	26	20	469.00
XA440*	NV1272/2SR	XA604	12	72	36	24	18	435.00
XA441*	NV12120/2SR	XA605	12	120	80	65	25	485.00
XA442*	NV12150/2SR	XA605	12	150	80	65	40	549.00
XA443*	NV12180/2SR	XB922	12	180	100	60	45	665.00
XA444**	NV12250/2SR	XB922	12	250	125	83	62	725.00
XA445	NV12360/2SR	XA606	12	360	180	120	90	795.00

* Two batteries required

** Three batteries required

SEALED LEAD ACID BATTERIES



XB922

XA604



Model No.	Mfg. No.	Description	Price /Each
XA604	BA-6-5.0BB	6 V, 5 Ampere-Hour	36.90
XA605	BA-6-12.0BB	6 V, 12 Ampere-Hour	51.90
XA606	BA-12-32.0BB	12 V, 32 Ampere-Hour	369.00
XB921	BA-6-7.2BB	6 V, 7.2 Ampere-Hour	44.90
XB922	BA-12-7.2BB	12 V, 7.2 Ampere-Hour	76.90

TEMPESTA™ LED EMERGENCY LUMINAIRES

- Uses two LED modules that are wired in parallel
- Will only illuminate during a power failure
- LEDs are rated for 100 000 hours at L70
- Input Voltage: 120 - 347 V
- Wattage: 17 W
- High quality corrosion, flame and vandal resistant polycarbonate housing
- Comes standard with a Ni-MH battery pack that provides a minimum of 30 minutes of emergency lighting
- IP65 Rating



Model No.	Mfg. No.	Description	Dimensions L" x W" x H"	Price /Each
XE874	TA-LED-EM-120-347V-S	Surface Mounted	17 x 6 1/2 x 3 1/2	699.00
XE875	TA-LED-EM-120-347V-R	Recessed	19 1/4 x 9 1/2 x 3 1/2	859.00
XE876	TA-LED-EM-120-347V-TB	T-Bar Mount	23 3/4 x 7 1/2 x 4	859.00

ILLUMINA® BS100 SERIES IP66 VAPOR-TIGHT

- Lightweight, durable 100% corrosion, flame and vandal resistant polycarbonate construction
- Designed to be resilient, highly efficient and easy to install
- For ceiling, wall, suspension and pendant installations
- UV stabilized to reduce the yellowing index
- Liquid silicone memory retention gasket allows for installations in wet locations
- Incorporates a "dual concave" parabolic high-output, metallized reflector
- Also approved for through wiring application



Model No.	Mfg. No.	Volts	Price /Each
XC441	BS10048T8232AC120V	120	189.00
XC442	BS10048T8232AC347V	347	219.00



LEVITON'S INDUSTRIAL SPECIFICATION GRADE LOCKING DEVICES ARE BUILT TO PROVIDE UNPARALLELED QUALITY AND SUPERIOR PERFORMANCE IN THE MOST SEVERE INDUSTRIAL SETTINGS.

- Leviton combines the best materials available with superior production standards to produce a broad selection of Locking Devices of unmatched flexibility and dependability.
- Uncompromising industrial-grade quality for superior performance and long service life
 - All industrial locking devices feature heavy-duty, impact-resistant construction
 - Plugs and connectors accept wide range of conductors
 - Terminals clearly identified on all devices to speed and simplify wiring
 - Backed by a limited 10-year warranty
 - Certified for sale in Canada by an accredited certification body

15 A 125 V 2-POLE 3-WIRE GROUNDING

Model No.	Mfg. No.	Description	Cord Diameter"	Wire Gauge stranded	Price /Each
XA872	24W47	Wetguard Locking Plug, High Visibility Yellow EPTR Body	0.240 - 0.655	12-18	45.50
XA873	25W47	Wetguard Locking Connector, High Visibility Yellow EPTR Body	0.240 - 0.655	12-18	66.90

15 A 125 V 2-POLE 3-WIRE GROUNDING

Model No.	Mfg. No.	Description	Cord Diameter"	Wire Gauge stranded	Price /Each
XC172	4720-C	Black and White Locking Plug	0.245 - 0.700	10-18	38.90
XC173	4729-C	Black and White Locking Connector	0.245 - 0.700	10-18	54.50

PVC GROUNDING PLUG

- Moisture and chemical resistant plastic body
- Ideal for indoor and outdoor use
- 15 A, 125 V

Model No.	Description	Nema Configuration	Colour	Cord Diameter"	Wire Gauge	Price /Each
XE672	PVC Grounding Plug	5-15P	Yellow	0.245 - 0.655	16/3 to 14/3 cords	3.25
XE673	PVC Grounding Connector	5-15R	Yellow	0.245 - 0.655	16/3 to 14/3 cords	5.10

COMMERCIAL GRADE STRAIGHT BLADE PLUGS

Commercial Specification Grade Straight Blade Plugs and Connectors are rugged performers. They are moisture, chemical and abuse-resistant. And they're ideal for indoor and outdoor use. All of these features and benefits are common to 15 A and 20 A Commercial Specification Grade Plugs and Connectors. TPE rubber-backed plugs and connectors stand up to rough use and protect against dirt and moisture. Deep-slotted, backed-out terminal screws draw backwire clamps securely over stripped leads for maximum conductivity.

15 A 125 V 2-POLE 3-WIRE GROUNDING

Model No.	Mfg. No.	Description	Colour	Cord Diameter"	Wire Gauge stranded	Price /Each
XA778	515PV	PVC Grounding Plug	Yellow	0.245 - 0.655	No. 18-3 thru 12-3 cords	4.39
XA779	515CV	PVC Grounding Connector	Yellow	0.245 - 0.655	No. 18-3 thru 12-3 cords	9.19

15 A 125 V STRAIGHT BLADE PLUGS & CONNECTORS, 2-POLE, 3-WIRE GROUNDING CONNECTORS

PLUGS				CONNECTORS		
Model No.	Mfg. No.	Description	Price /Each	Model No.	Mfg. No.	Price /Each
XA780	14W47	Wetguard, High Visibility	50.90	XA781	15W47	68.90
XA775	5256-VY	Python, High Visibility	12.50	XA776	5259-VY	19.50
XA777	5256-VA	Python Angle, High Visibility	14.90			

CORROSION RESISTANT DEVICES

Corrosion resistant devices are specifically designed for extremely damp and corrosive environments. They offer additional corrosive resistance because the metal parts (blades, contacts, terminals and screws) are nickel-plated. They have also passed the ASTM (B117.13) 500 hour Salt Spray (Fog) Test.

- Cord clamp seats flush with body for all cable sizes from 10-3 ST to 18-3 SVT (.245"-.700"), providing positive strain relief while preventing damage to cable jacket
- Captive, brass #8 terminal screws are colour coded for easy wiring identification: green (ground), brass (hot) and silver (neutral)

15 A 125 V 2-POLE 3-WIRE GROUNDING STRAIGHT BLADE

Model No.	Mfg. No.	Description	Nema Configuration	Price /Each
XA848	52CM-66C	Straight Blade Plug, Yellow Nylon Body and Cord Clamp	5-15P	42.50
XA849	52CM-69C	Straight Blade Connector, Yellow Nylon Body and Cord Clamp	5-15R	65.50

LEVITON

Wetguard

Nema Configuration



L1-15R L1-15P



XA872



XA873

BLACK & WHITE

Nema Configuration



L5-15P L5-15R



XC172



XC173

AURORA
TOOLS



XE672



XE673

LEVITON

Nema Configuration

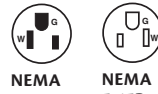

NEMA 5-15P NEMA 5-15R



XA779



XA778

Nema Configuration



NEMA 5-15P NEMA 5-15R



XA780



XA777

LEVITON

Nema Configuration



5-15P 5-15R



XA848



ELECTRICAL TAPE

- Vinyl plastic
- Excellent recovery, molds snugly to any surface
- Ideal for electrical splicing and insulation; protection against solvents and corrosion
- For use between -7°C and 80°C
- Thickness: 7 mils
- CSA approved



AURORA
TOOLS

Model No.	Colour	Dimensions	Price /Each
XE890	Black	3/4" x 60' (19 mm x 18 m)	1.25
XH383	Red	3/4" x 60' (19 mm x 18 m)	1.25
XH384	Green	3/4" x 60' (19 mm x 18 m)	1.25

Model No.	Colour	Dimensions	Price /Each
XH385	Blue	3/4" x 60' (19 mm x 18 m)	1.25
XH386	White	3/4" x 60' (19 mm x 18 m)	1.25
XH387	Yellow	3/4" x 60' (19 mm x 18 m)	1.25

TEMFLEX™ GENERAL USE VINYL ELECTRICAL TAPE 165

- Resists abrasion, moisture, alkalis, solvents and acids
- Flame-retardant and helps inhibit the corrosion of electrical conductors
- Made of durable PVC
- Compatible with rubber and synthetic splicing compounds
- UL Listed, CSA and VDE Certified
- Provides great mechanical protection with minimum bulk
- Width: 19 mm (3/4")
- Length: 18 m (60')
- Thickness: 6 mils
- Elongation at Break: 200%
- Maximum Operating Temperature: 194°F (90°C)
- Minimum Operating Temperature: 32°F (0°C)
- Shelf Life: 1825 Days
- Voltage Rating: 600 V



3M

Model No.	Mfg. No.	Colour	Price /Each
XI861	165BK4A	Black	1.85
XI862	165BL4A	Blue	1.96
XI863	165BR4A	Brown	1.96
XI864	165GY4A	Grey	1.96
XI865	165GR4A	Green	1.96
XI866	165OR4A	Orange	1.96
XI867	165RD4A	Red	1.96
XI868	165WH4A	White	1.96
XI869	165YL4A	Yellow	1.96
XI870	165PR4A	Purple	1.96

TEMFLEX™ VINYL ELECTRICAL TAPE 1700

- The combination of the rubber-resin adhesive and the PVC backing offers excellent electrical and mechanical protection
- Withstands a temperature range of 32 to 176 °F (0 to 80 °C)
- UL Listed, CSA Certified and RoHS 2002/95/EC
- This flame retardant tape is designed for protective jacketing and harnessing
- Ideal for indoor and outdoor applications
- Highly resistant to UV rays, moisture, alkalis, acids, copper corrosion and varying weather conditions
- Provides a protective jacket for high voltage cable splices and repairs
- Width: 25.4 mm (1")
- Length: 20.1 m (66')
- Thickness: 7 mils
- Elongation at Break: 200%
- Insulation Resistance: > 10⁶ megohms
- Max. Operating Temperature: 80°C (176°F)
- Shelf Life: 1825 Days
- Voltage Rating: 600 V



3M

Model No.	Mfg. No.	Colour	Price /Each
XI873	1700-1X66	Black	6.41

SCOTCH® 27 GLASS CLOTH ELECTRICAL TAPE

- Ideal for electrical maintenance applications
- Woven glass cloth tape with a rubber thermosetting pressure-sensitive adhesive
- Edge-tear resistant, conformable, abrasion resistant
- For use as a coil cover, anchor, banding and core, layer and crossover insulation, and for heat-stable insulation for furnace and oven controls, motor leads, and switches
- Thickness: 7 mils
- UL recognized 130°C/266°F



3M

Priced per Roll

Model No.	Dimensions	Rolls/Case	Price/Each
XH289	1/2" x 66' (12 mm x 20.1 m)	10	27.33
XC322	3/4" x 66' (19 mm x 20.1 m)	50	41.33

SCOTCH® SUPER 33+ VINYL TAPE

- All weather, premium grade vinyl tape for primary insulation up to 600 V or protective jacketing for low/medium voltage cable splices and repairs
- Aggressive adhesive and elastic backing ensures easy conformation to irregular surfaces for moisture tight electrical and mechanical protection
- Will perform in a continuous temperature environment up to 220°F (105°C)
- Conformable for cold weather applications: 0°F (-18°C)
- Thickness: 7 mil
- Colour: Black
- UL and CSA approved



3M

Priced per Roll

Model No.	Dimensions	Roll /Case	Price /Each
PC693	3/4" x 66' (19 mm x 20.1 m)	100	12.13

ELECTRICAL DEVICES & ACCESSORIES

SCOTCH® SUPER 88 VINYL TAPE

- All weather, premium grade vinyl tape for primary insulation up to 600 V or protective jacketing for low/medium voltage cable splices
- Aggressive adhesive and elastic backing ensures easy conformation to irregular surfaces for moisture tight electrical and mechanical protection
- Will perform in a continuous temperature environment up to 220°F (105°C)
- Conformable for cold weather applications: 0°F (-18°C)
- Thickness: 7 mil
- Colour: Black
- UL and CSA approved



Priced per Roll

Model No.	Dimensions	Roll /Case	Price /Each
PC694	3/4" x 66' (19 mm x 20.1 m)	100	13.57

SCOTCH® 130C LINERLESS RUBBER SPLICING TAPE

- Highly conformable, linerless self-bonding ethylene propylene rubber (EPR) tape for insulating all solid dielectric cables up to 69 kV
- Excellent thermal dissipation of splice heat
- Meets industry specifications, excellent physical and electrical properties
- Immediate moisture sealing and void-free buildups
- Rated up to 194°F (90°C) continuous operation and up to 266°F (130°C) short-term overload service
- Having no liner makes jobs easier and saves time
- Thickness: 30 mils



Priced per Roll

Model No.	Dimensions	Rolls/Case	Price/Each
AF284	3/4" x 30'	24	30.24
XC323	1" x 30'	24	40.30
XH307	1-1/2" x 30'	12	60.40

SCOTCH® 35 COLOUR CODING VINYL TAPE

- Premium grade vinyl electrical colour-coding tape for phase and job identification and safety
- Heavy-duty, premium grade
- Temperature rating: 220°F/105°C
- Thickness: 7 mil
- UL and CSA approved



Priced per Roll

Model No.	Colour	Dimensions	Rolls /Case	Price /Each
PC696	Blue	1/2" x 20'	100	4.54
PC720	Green	1/2" x 20'	100	4.54
PC721	Red	1/2" x 20'	100	4.54
PC722	White	1/2" x 20'	100	4.54
PC723	Yellow	1/2" x 20'	100	4.54
XC309	Orange	1/2" x 20'	100	4.54
PE118	Blue	3/4" x 66'	100	12.35
PE120	Green	3/4" x 66'	100	12.35
XC312	Red	3/4" x 66'	100	12.35
PE119	White	3/4" x 66'	100	12.35
XC314	Yellow	3/4" x 66'	100	12.35
XC315	Orange	3/4" x 66'	100	12.35

SCOTCHLOK™ ELECTRICAL INSULATION DISPLACEMENT CONNECTORS

- Ideal for controlling circuit wiring, appliance wiring, signal, and PA system or automotive/boat/RV wiring
- Features flame retardant properties
- Designed to connect a wire end to a through wire and insulates the connection
- Insulation Material: Polypropylene
- Connection Type: Run and Tap
- Maximum Operating Temperature: 105°C
- Maximum Recommended Voltage Rating: 600 V
- Conductor Size: 22 - 16 AWG
- Quantity Per Pack: 100

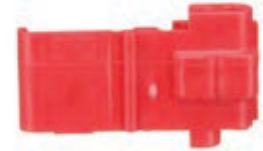

Priced per Pack

Model No.	Mfg. No.	Price /Each
XH543	558-BOX	58.80

NON-CONTACT VOLTAGE & MAGNETIC FIELD DETECTOR

- AC voltage and magnetic field detector with built-in flashlight
- Check receptacles or insulated wire for presence of AC voltage
- Quickly determine the presence of magnetic fields to determine whether or not components are working properly
- Double insulated housing for increased safety
- Audible (buzzer) and visual (LED) indicators
- Built-in flashlight
- Pocket clip
- Auto shut-off
- Two voltage ranges allow it to detect both high (90 to 1000 V) and low (24 to 1000 V) AC wiring
- Power Supply: (2) AAA Batteries
- Certification(s): CE, IP67, ETL (Conforms to UL STD 61010-1, 61010-2-030, Certified to CSA STD C22.2 No. 61010-1, 61010-2-030)

REED



Model No.	Mfg. No.	Description	Price /Each
IC856	R5120	Non-Contact Voltage & Magnetic Field Detector	30.00

WIRE TRACER & CIRCUIT TESTING KIT

- Multi-purpose intelligent line tracer/tracker identifies and validates cables from source to termination quickly and accurately
- Test modes include; identifying and locating wires, validating cable/line connections, verifying telephone line continuity/line polarity
- Modular adapters provide direct connection to RJ45 and RJ11 wiring
- Alligator clip adapter allows for easy connection to non-terminated cables
- Adjustable sensitivity wheel improves wire identification and eliminates false detection
- Visual (flashing LEDs) and audible (pulsating beeper) indicators
- Integrated flashlight supports applications in low lit environments
- Built-in non-contact voltage detector
- Earphone jack for loud environments (earphones sold separately)
- Rechargeable batteries
- Low battery indicator and auto shut-off
- Includes: Transmitter, Receiver, Micro-USB charging cable, RJ11 adapter cable, RJ45 adapter cable, RJ11 alligator clip adapter cable, Carrying case
- Certifications: CE, RoHS



REED

Model No.	Mfg. No.	Description	Price /Each
IC752	R5320	Wire Tracer & Circuit Testing Kit	119.00

FLASHLIGHTS

CREE® PENLIGHT

- High-quality Cree® LED beam is very bright
- High-quality penlight is extremely durable all while being lightweight to alleviate wrist fatigue
- Aluminum body is corrosion and rust-resistant
- Push button to switch on and off
- Attaches securely to pockets, belts and briefcases with convenient clip
- Penlight is ideal for various applications such as household work, automobile maintenance and recreational activities
- Lumens (High): 90
- Run Time Hrs. (High): 3
- Body Material: Aluminum
- Battery Type: AAA (included)
- Body Colour: Black
- Beam Distance (High): 70 m
- Light Colour: White

Model No. XJ058
Price/Each \$17.95



AURORA
TOOLS

AFL200 MINI LED FLASHLIGHTS

- Nine ultra bright LED lights
- High-strength aluminum casing
- On/Off switch
- Lightweight design
- Rugged impact resistant housing
- Includes wrist strap and three AAA alkaline batteries



AURORA
TOOLS

Model No.	Lumens	Price /Each
XD079	25	9.95

AFL300 LED FLASHLIGHTS

- High strength aluminum casing
- Shatterproof lens
- Batteries included
- Colour: Black
- XJ059: 3 lighting settings: Low 9 LED, Medium 24 LED and High 45 LED



XE888



XJ059

AURORA
TOOLS

Model No.	Lumens	Run Time Hrs	Batteries Required	Beam Distance	Bulb	Price /Each
XE888	98	3	3 x AAA	35 m	28 LED	13.95
XJ059	180	10	3 x AA	48 m	45 DEL	18.50

AFL100 LED FLASHLIGHTS

- Super bright LED bulb
- Polypropylene body resists grease and chemicals
- Shatterproof lens
- Ribbed non-slip barrel
- Hi-Viz yellow colour for easy visibility
- Batteries not included



AURORA
TOOLS

Model No.	Description	Lumens	Price /Each
XC977	Flashlight, 2 AA-Cells	28	4.25
XC978	Flashlight, 2 D-Cells	35	6.99

WORKHORSE™ HANGING RING FLASHLIGHT

- Tough polypropylene body
- Impact resistant to 7 Feet
- Water, grease and corrosion resistant
- Consumer-preferred comfort grip
- The protected slide switch ensures the light stays off in storage so it's ready to go when you need it
- Extra-tough hanging ring
- (2) D zinc chloride batteries included
- Lamp Type: LED
- Run Time Hrs. (High): 55
- Beam Distance (High): 32 m
- Manufacturer's Warranty: Lifetime



RAYOVAC

Model No.	Mfg. No.	Lumens	Price /Each
NJX734	WHH2D-BA	20	14.40

AFL400 RECHARGEABLE LED SPOTLIGHT

- Single LED spotlight has an extremely bright beam featuring long distance visibility
- Spotlight features an additional side-light that can be used as a free-standing lantern
- Certified for sale in Canada by an accredited certification body
- Spotlight is ideal for various applications, such as household work, facility maintenance, general labor and recreational activities
- Run Time Hrs. (High): 6
- Battery Type: Rechargeable
- Body Colour: Black
- Body Material: Plastic
- Beam Distance (High): 500 m
- Batteries included
- Side-light Lumens: 180



AURORA
TOOLS

Model No.	Lumens	Price /Each
XH109	516	48.95

EVERREADY® READYFLEX™ FLOATING LANTERN

- Bright and dependable lantern
- Operates on 2 or 4 D cell batteries
- Runs up to 140 hours on 4 carbon zinc batteries and 350 hours on 4 alkaline batteries
- Includes 2 carbon zinc D batteries
- All packaging is recyclable
- Lamp Type: LED
- Beam Distance (High): 175 m
- Body Material: Plastic



Energizer

Model No.	Mfg. No.	Lumens	Price /Each
NJ0241	EVGPLN45H	80	11.90

VISION HD FLASHLIGHTS

- Can be used on high, power-saver and emergency strobe modes
- Includes six Energizer® AA batteries
- Survives drops up to 1 metre
- Lamp Type: LED
- Run Time Hrs. (High): 4
- Body Material: Aluminum
- Body Colour: Black
- Beam Distance (High): 230 m
- Water Resistance Rating: IPX4



Energizer

Model No.	Mfg. No.	Lumens	Price /Each
XH023	EPMZH61E	1300	44.15

HARD CASE PROFESSIONAL™ 2 AA LED FLASHLIGHTS

- Water resistant IPX4
- Shatterproof lens
- Impact resistant steel plate bolted sides
- Run time: High 6 hrs. 30 min., Low 65 hrs.
- Includes 2 long lasting AA Energizer® alkaline batteries
- Beam distance: 115 meters



Energizer

Model No.	Mfg. No.	Description	Lumens High/Low	Price /Each
XC234	TUF2AAPE	Flashlight, 2 AA-Cells	300/45	23.69
XB872	EN91	Replacement Batteries AA-Cell, 24/Pkg.	-	18.00

HARD CASE® RUGGED WORK LIGHT

- Rugged 6 LED work light with dual mode light output
- Includes a retractable rotating hook
- Magnets on the side
- Wide base for extra stability
- Survives 7 meter drops
- Shatterproof lens
- All packaging is recyclable
- Beam Distance (High): 4 m
- Run Time Hrs. (High): 8
- Run Time Hrs. (Low): 40
- Body Colour: Black, Grey
- Body: Hard Plastic
- Batteries Required: 4 x AA (included)



Energizer

Model No.	Mfg. No.	Lumens High/Low	Price /Each
XE677	HCAL41E	550/150	42.40

INTRINSICALLY SAFE® HANDHELD FLASHLIGHTS

- Waterproof, dustproof and impactproof
- Built-in carabiner belt clip makes for easy access
- Orange safety colour provides instant recognition
- Shatterproof lens
- Ribbed casing for secure grip
- Built for safe use in environments with water, gas, and dust
- Lamp Type: LED
- Run Time Hrs. (High): 12
- Body Material: Plastic
- Battery Type: AA
- Batteries not included
- Beam Distance (High): 175 m
- No. of Batteries: 2
- Water Resistance: IP67
- Impact Resistance: 1 m



Energizer

Model No.	Mfg. No.	Lumens	Price /Each
XI356	ENSHH21E	150	26.60

AURORA TOOLS

Celebrating **15 YEARS**

EXCEEDING EXPECTATIONS

HARD CASE® PROFESSIONAL SPOT LIGHTS

- LEDs produce a tight white spot light
- Intense focused beam
- High and Low modes for brightness and run time control
- Ideal for long distance applications and searching
- Shatterproof lens
- Water resistant
- Rugged construction
- Durable light survives drops up to 7 meters
- Run time: High 6 hrs. 15 min., Low 22 hrs.
- Beam Distance: 425 m
- Material: Hard Plastic
- Colour: Black/Grey
- Includes 6 AA batteries



Energizer

Model No.	Mfg. No.	Description	Lumens High/Low	Price /Each
XE475	HCSP61E	Spot Light, 6 AA Cells	600/215	48.52
XB872	EN91	Replacement Batteries AA-Cell, 24/Pkg.	-	18.00

FLASHLIGHTS

HP4 PEN LIGHTS

- Features a Bulls-Eye Spot Beam that fixes a bright "hot spot" on the object, surrounded by a soft halo of transitional light to increase the total field of view
- Beam range of up to 416 ft. (127 m)
- Water resistant
- Lamp Type: LED
- Run Time Hrs. (High): 3.5
- Body Material: Aluminum
- Battery Type: AAA
- Body Colour: Black
- Beam Distance (High): 55 m
- Batteries included
- Light Colour: White
- Length: 5.5"
- Weight: 2.2 oz.



COAST

Model No.	Mfg. No.	Lumens	Price /Each
XI143	21217	100	30.79

G20 PENLIGHTS

- Impact and weather resistant
- Tested and rated to ANSI/FL1 standards
- Pocket clip included
- Lamp Type: LED
- Run Time Hrs. (High): 10
- Material: Aluminum
- Battery Type: AAA
- Beam Distance (High): 22 m
- Batteries Included
- Beam Optic: Inspection Beam



COAST

Model No.	Mfg. No.	Colour	Price /Each
XE980	20254	Black	22.49

DUAL-COLOUR CLIPLIGHTS

- Chip on Board (C.O.B) technology means this headlamp can cast a wide beam, and is also handy for up-close work due to the strip of LEDs built right onto the chassis
- Features a dual-colour function; all-white utility beam for general use, and a red, anti-glare beam that prevents "night blinding"
- Magnetic tail cap means you can attach the light to magnetic surfaces and use the light hands-free
- Two-way clip means you can stash the light in your pocket or clip it to the brim of your hat
- Water resistant
- Run Time Hrs. (High): 3.75
- Body Material: Aluminum
- Battery Type: AAA
- Body Colour: Black
- Beam Distance (High): 13 m
- Batteries included
- Light Colour: Red, White



COAST

Model No.	Mfg. No.	Lumens	Price /Each
XI144	21676	80	23.89

HP7 FLASHLIGHTS

- Anti-roll feature allows the flashlight to be on an uneven surfaces without running the risk of it rolling off
- Tested and rated to ANSI/FL1 standards
- Lamp Type: LED
- Lumens (High): 410
- Run Time Hrs. (High): 2
- Body Material: Aluminum
- Battery Type: AAA
- Beam Distance (High): 229 m
- Batteries Included
- Modes: High, medium, and low



COAST

Model No.	Mfg. No.	Lumens	Price /Each
XE965	20406	410	75.59

PX250 AREA & FLASHLIGHTS

- Chip on Board (C.O.B) technology means this headlamp can cast a wide beam, and is also handy for up-close work due to the strip of LEDs built right onto the chassis
- Twist and open the flashlight to expose the LED, dual-colour strip in the center
- Features COAST's Twist Focus system, making it easy to move between spot and flood beams by simply rotating the head of the flashlight
- Ultra View Flood beam delivers edge-to-edge clarity in a broad circle of light up to 11.5' (3.5 m) across, and the Bulls-Eye Spot beam sends a sharp ray of light at a distance of up to 663' (202 m)
- Features an emergency signalling tool
- Features a hinged, tilting head
- Hardhat compatible
- Water resistant
- Runs on 3 x AAA
- Includes hardhat clips
- Lamp Type: LED
- Body Material: Aluminum
- Body Colour: Black, Red
- Batteries included



COAST

Model No.	Mfg. No.	Lumens	Price /Each
XI145	21759	650	73.99

HX5R RECHARGEABLE FLASHLIGHTS

- Features a USB insert found in the tail cap which can be used with USB, AC, & DC adapters
- Dual Power system allows the light to run on the custom rechargeable battery and a standard C123 alkaline battery
- Two-way clip makes it easy to clip in either direction on pockets or even the bill of a hat
- Pure Beam Focusing System with Slide Focus can easily transition from flood to spot modes with one hand
- Ultra View Flood beam delivers edge-to-edge clarity in a broad circle, and the Bulls-Eye Spot beam sends a sharp ray of light at a distance with a transitional halo around the spot to increase the effective viewing area
- Impact and water-resistant
- Includes: (1) Lithium Ion rechargeable battery, (1) AC with USB adapter, (1) DC with USB adapter, (1) Lanyard
- Lamp Type: LED
- Run Time Hrs. (High): 1.5
- Run Time Hrs. (Low): 4.25
- Body Material: Aluminum
- Body Colour: Black
- Beam Distance (High): 178 m
- Beam Options: High, Strobe, Light



COAST

Model No.	Mfg. No.	Lumens High/Low	Price /Each
XI430	21673	340/75	49.99

HP8R RECHARGEABLE FLASHLIGHTS

- Lightweight aluminum body
- Tested and rated to ANSI/FL1 standards
- Operates with rechargeable lithium-ion battery pack or standard AAA alkaline batteries
- Lamp Type: LED
- Run Time Hrs. (High): 2
- Body Material: Aluminum
- Body Colour: Black
- Batteries included
- Beam Distance (High): 213 m
- Beam Distance Low (Rechargeable): 60 m
- Run Time Low (Rechargeable): 26 hrs.
- Beam Distance High (Alkaline): 175 m
- Run Time High (Alkaline): 0.5 hrs.
- Modes: High, medium, and low
- Beam Optic: Pure Beam
- Length: 6.125" (15.6 cm)



COAST

Model No.	Mfg. No.	Lumens (Rechargeable) High/Low	Lumens (Alkaline) High	Price /Each
XE934	21442	760/61	515	141.00

HX5 FLASHLIGHTS

- Operates with standard AA alkaline batteries (included) or with rechargeable NiMH/Lithium batteries (sold separately)
- Impact and weather resistant
- Tested and rated to ANSI/FL1 standards
- Two-way clip included
- Lamp Type: LED
- Run Time Hrs. (High): 3.75
- Body Material: Aluminum
- Body Colour: Black
- Batteries included
- Beam Distance (High): 79 m
- Mode: High
- Beam Optic: Pure Beam
- Length: 4" (10.16 cm)



COAST

Model No.	Mfg. No.	Lumens	Price /Each
XE972	20830	130	35.39

400 PURE BEAM FOCUSING FLASHLIGHTS

- Waterproof, drop proof, and crush proof
- Cycle between full light, medium light, and low light options with the push of a button
- Pure Beam Focusing System with Twist Focus can easily transition from flood to spot modes by simply rotating the head of the flashlight
- Ultra View Flood beam delivers edge-to-edge clarity in a broad circle
- Bulls-Eye Spot beam sends a sharp ray of light at a distance with a transitional halo around the spot to increase the effective viewing area
- Lamp Type: LED
- Run Time Hrs. (High): 3
- Run Time Hrs. (Medium): 7
- Run Time Hrs. (Low): 29
- Body Material: Polysteel
- Body Colour: Black
- Battery Type: AAA
- Batteries included
- Beam Distance (High): 210 m
- Beam Options: High, Medium, Low
- No. of Batteries: 4
- Length: 5-3/4"
- Weight: 6.4 oz.
- IP Rating: IPX8



COAST

Model No.	Mfg. No.	Lumens High/Medium/Low	Price /Each
XI429	20860	440/200/60	36.49

POLYSTEEL FLASHLIGHTS

- Impact resistant and waterproof
- Tested and rated to ANSI/FL1 standards
- Pure Beam Optic System allows for good visibility in all types of weather
- Lamp Type: LED
- Body Material: Plastic
- Body Colour: Black
- Batteries included
- Modes: High, medium and low
- Beam Optic: Pure Beam



XE932

COAST

Model No.	Mfg. No.	Battery Type	Lumens High/Low	Run Time High/Low	Beam Distance High/Low	Length"	Price /Each
XE933	20466	AAA	320/30	3.75/34 hrs.	118/37 m	5	30.19
XE932	20835	AA	710/73	2.25/40 hrs.	247/78 m	7.9	47.49

G26 FLASHLIGHTS

- Impact and weather resistant
- Tested and rated to ANSI/FL1 standards
- Lamp Type: LED
- Run Time Hrs. (High): 3.25
- Beam Distance (High): 32 m
- Body Material: Aluminum
- Body Colour: Black
- Battery Type: AA
- Batteries included
- Mode: High
- Beam Optic: Utility Beam
- Length: 6.05" (15.36 cm)



COAST

Model No.	Mfg. No.	Lumens	Price /Each
XE979	20402	120	33.29

G32 FLASHLIGHT

- Impact and weather resistant
- Tested and rated to ANSI/FL1 standards
- Pocket clip included
- Lamp Type: LED
- Lumens (High): 355
- Run Time Hrs. (High): 0.78
- Beam Distance (High): 132 m
- Body Material: Aluminum
- Body Colour: Black
- Battery Type: AA
- Batteries included
- Mode: High
- Beam Optic: Pure Beam
- Length: 6.4" (16.3 cm)



COAST

Model No.	Mfg. No.	Lumens	Price /Each
XE978	21440	355	37.09

FLASHLIGHTS

PENLIGHTS

- The integrated clip can be mounted to a safety vest for hands free lighting
- Engineered with an aluminum core and ABS overmolded plastic, the Pelican™ 1970 penlight can survive tough work environments, yet is slim enough to snap into the available helmet mount or hold with your teeth
- Activates with a click of the tail switch or light pressure for momentary use
- Powered by 2 AAA alkaline batteries
- Lamp Type: LED
- Run Time Hrs. (High): 4.3
- Body Material: Plastic
- Body Colour: Black
- Beam Distance (High): 29 m
- Batteries included
- Light Colour: White
- Weight: 1.8 oz.
- Length: 5.75"
- IP Rating: IPX4



Model No.	Mfg. No.	Lumens	Price /Each
XI293	019700-0100-110	139	31.50

3315 COMPACT LED FLASHLIGHTS

- Compact, rugged and lightweight
- Constructed of high impact ABS
- Powered by three AA alkaline batteries (included)
- Water resistant IPX4
- Class I II III, Div. 1, GP. ABCDEFG T4 Exia
- Lamp Type: LED
- Run Time Hrs. (High): 19
- Body Material: Plastic
- Body Colour: Yellow



Model No.	Mfg. No.	Lumens	Price /Each
XD019	033150-0103-245	160	72.90

5050R RECHARGEABLE FLASHLIGHTS

- Flood position projects a wide beam to illuminate your work area and spot beam for a long distance focused beam
- Recharge by connecting directly to its Micro USB port or connect to a USB port to power your smartphone or any other USB powered device
- Powered by one lithium-ion 18650 rechargeable battery
- Lamp Type: LED
- Run Time Hrs. (High): 2.5
- Run Time Hrs. (Low): 40
- Body Material: Aluminum
- Body Colour: Black
- Batteries included
- Beam Distance (High): 134 m
- Weight: 5.8 oz.
- Length: 6.16"
- Light Modes: Boost, High, Low, Flashing
- IP Rating: IPX8
- Charge Time: 6 hrs.
- Voltage: 3.7 V



Model No.	Mfg. No.	Lumens High/Low	Price /Each
XI302	050R-0100-110	393/21	155.00

2360 LED FLASHLIGHTS

- Tactical tail switch offers one-handed operation
- Removable pocket clip delivers convenient transport options
- Impact resistant construction for long lasting service life
- High & low power modes provide versatile lighting options
- Lamp Type: LED
- Run Time Hrs. (High): 2.5
- Run Time Hrs. (Low): 13
- Beam Distance (High): 150 m
- Body Material: Aluminum
- Body Colour: Black
- Battery Type: AA
- Batteries included



Model No.	Mfg. No.	Lumens High/Low	Price /Each
XC807	023600-0002-110	375/29	88.50

SABRELITE™ LED FLASHLIGHTS

- Polycarbonate lens
- One-handed safety switch operation
- Submersible
- Lamp Type: LED
- Run Time Hrs. (High): 22
- Body Material: Plastic
- Batteries Required: 3 C (not included)
- Body: EXL
- Approvals: Class I Div. 1, Class II Div. 1, Class III Div. 1, IECEx ia



Model No.	Mfg. No.	Lumens	Body Colour	Price /Each
XC061	2010-014-110	161	Black	135.00
XC062	2010-014-245	161	Yellow	135.00

STEALTHLITE™ LED FLASHLIGHTS

- Cutting edge Recoil™ LED Technology™, up to 33 times brighter than regular LED lights
- ABS body with polycarbonate lens
- One-handed safety switch operation
- Submersible to 500'
- Lamp Type: LED
- Run Time Hrs. (High): 7.5
- Body Material: Plastic
- Beam Distance (High): 184 m
- Batteries Required: 4 AA (Included)
- Approvals: FM Class I, Div. 2, Groups ABCD, T4A; Class II, Div. 2, Groups FG



Model No.	Mfg. No.	Lumens	Body Colour	Price /Each
XC066	2410-014-110	183	Black	135.00
XC067	2410-014-245	183	Yellow	135.00

MAGNETIC RIGHT ANGLE FLASHLIGHTS

- Equipped with both a spot and flood LED for close-up as well as distance
- Can be activated to run one or both LEDs with 3 levels of brightness
- The articulating head and built-in clip allows the light to be directed wherever it is needed
- Security lanyard
- A heavy-duty magnet allows the light to be snapped to steel surfaces
- The Class I, II, III, Division 1 certifications provide the security needed for most hazardous locations
- Powered by 3 AA alkaline batteries
- Run Time Hrs. (High): 6
- Run Time Hrs. (Low): 15
- Beam Distance (High): 133 m
- Body Material: Plastic
- Body Colour: Yellow
- Batteries included
- Weight: 9.6 oz.
- Length: 7.44"
- Light Modes: Spot/Flood, Flood, Spot, Flashing
- Certification(s): Class I, Division 1 / Class II, Division 1 / Class III, Division 1 / IECEx ia
- IP Rating: IPX8



Model No.	Mfg. No.	Lumens High/Low	Price /Each
XI300	034150-0301-245	336/177	91.90

STYLUS PRO® & MICROSTREAM® PENLIGHTS

- Compact, high-powered LED penlights provide a super bright beam
- Constructed of corrosion proof, machined aircraft-grade aluminum alloy with Type II MIL-Spec anodized plating
- 30 000 hour lifetime 0.5 watt LED never needs to be replaced
- Water resistant per code IPX4; in accordance with specification EN 60529:1992
- Tail switch features momentary blink and constant "on" modes
- Matte black finish



STYLUS PRO®

- Run time: Up to 8 regulated hours
- Includes: 2 AAA alkaline batteries, nylon holster and pocket clip **XC394**

MICROSTREAM®

- Run time: Up to 2.25 hours
- Includes: 1 AAA alkaline battery, pocket clip and lanyard



Model No.	Mfg. No.	Description	Lumens	Price /Each
XC394	66118	Stylus Pro®	100	48.50
XC395	66318	Microstream®	45	41.50

STYLUS® PENLIGHTS

- High intensity LED lasts 100 000 hours
- Up to 24 hours of continuous run time
- XB942 has a flexible cable making it possible to see anywhere
- Includes 3 AAAA alkaline batteries
- Black casing with pocket clip



Model No.	Mfg. No.	Description	Lumens	Price /Each
XB943	65118	Stylus® Penlight, 3.5 oz.	11	33.50
XB942	65618	Stylus Reach® Penlight - 7" Cable, 3.5 oz.	11	45.50

RIGHT ANGLE 3715 LED FLASHLIGHTS

- Compact, rugged and lightweight
- Featuring downcast LEDs for illuminating your path
- Built-in battery life indicator
- Powered by four AA alkaline batteries (not included)
- Water-resistant IPX4
- Class I, Div. 1 Groups ABCD Operating Temp. Class T4
- Run Time Hrs. (High): 4
- Run Time Hrs. (Low): 7
- Lumens (Downcast): 31
- Run Time Hrs. (Downcast): 31
- Body Material: Plastic
- Body Colour: Yellow



Model No.	Mfg. No.	Lumens High/Low	Price /Each
XD017	3715-020-245	223/113	259.00

PROTAC® PROFESSIONAL TACTICAL LIGHTS

- 6000 Series machined aircraft aluminum with anodized finish
- Super bright C4® LED is impervious to shock and has a 50 000 hour lifetime
- LED solid state power regulation provides maximum output throughout battery life
- IPX rated design; waterproof to 1 m for 30 minutes
- Ten-Tap™ programmable switch allows selection of one of three programs: High/Strobe/Low, High only or Low/High
- Includes batteries and holster



Model No.	Mfg. No.	Description	Lumens	Run Time hrs.	Battery	Price /Each
XC771	88031	ProTac® 2L	300	3	Two 3 V Lithium	125.00
XC773	88033	ProTac® 2 AA	250	2	Two AA Alkaline	97.90

STREAMLIGHT JR.® LED FLASHLIGHTS

- Super bright C4® LED is impervious to shock and provides up to 225 lumens
- Push-button tail switch - steady on and momentary on/off operation
- Impact-resistant/water-resistant
- XC247 includes holster
- XC248 includes extension cable that allows for 14" of reach, flexible cable protected by a durable PVC coating, packaged with magnetic clip holder for mounting and positioning
- XC248: Beam Distance: 77 m
- Includes 2 AA size alkaline batteries (also accepts 2 AA lithium batteries not included)



Model No.	Mfg. No.	Description	Lumens	Run Time hrs.	Price /Each
XC247	71500	Streamlight Jr® LED w/Alkaline Batteries, Black	225	6	77.50
XC248	71600	Streamlight Jr. Reach® LED Flashlight	115	7.5	96.50
BATTERIES					
XB872	EN91	Replacement Batteries, AA Cell, 24/pkg.	-	-	18.00/Pkg.

FLASHLIGHTS

PROTAC® HL & HL3 TACTICAL FLASHLIGHTS

- Hand-held, lithium battery-powered programmable flashlight constructed of anodized machined aircraft aluminum
- IPX7; waterproof to 1 meter for 30 minutes
- Impact resistant to 1 meter
- Multi-function, push-button tail switch for one-handed operation
- Choice of three operating modes: 1) high/strobe/low (factory default), 2) high only, 3) low/high
- Lamp Type: C4 LED
- Includes two 3 V CR123A lithium batteries and nylon holster



Model No.	Mfg. No.	Description	Lumens		Run Time hrs.		Price /Each
			High	Low	High	Low	
XC954	88040	ProTac® HL	750	35	1.25	18	189.00

3AA PROPOLYMER® DUALIE® FLASHLIGHTS

- C4® LED technology for extreme brightness
- IPX7 waterproof to 1m for 30 minutes
- 2 metre impact resistance tested
- Durable, non-conductive, corrosion-proof polymer resin body
- Lamp Type: LED
- Run Time Hrs. (High): 18
- Battery Type: AA
- Beam Distance (High): 171 m
- Batteries included



Model No.	Mfg. No.	Lumens	Body Colour	Price /Each
XE760	68750	140	Yellow	73.50
XE761	68752	140	Black	73.90

TWIN-TASK® LED FLASHLIGHTS

- Super bright C4® LED is impervious to shock and has a 50000 hour lifetime
- Unbreakable polycarbonate lens
- IPX4 rated for water-resistant operation, all openings are O-ring sealed, 1 meter impact resistance tested and wrist lanyard included
- Features: 2 hr 45 min on one LED, 5 hr 15 min on five LEDs
- Battery: 3 AAA size alkaline batteries, Output: One LED - 100 lumens, five LEDs - 68 lumens
- Pre-focused visible red laser cartridge, laser output: Useable range of over 100 yards when using laser pointer only; over 100' when in laser/C4® LED combo position



Model No.	Mfg. No.	Lumens	Price /Each
XC762	51043	100	92.20

DUALIE® RECHARGEABLE INTRINSICALLY SAFE FLASHLIGHT

- Impact and chemical resistant, non-conductive, sealed and vented engineered polymer resin casing
- Features two white LEDs that are impervious to shock with a 50000 hour lifetime
- Spot function uses a smooth parabolic reflector that produces a tight beam with optimum peripheral illumination
- Flood beam produces a soft, wide beam to illuminate work area
- Spot and flood beams intersect for an uninterrupted light pattern to eliminate blind spots
- Rugged, integrated, snag-free clip conforms to body of light
- One-handed operation of all lighting modes
- Ergonomically designed for maximum hand comfort
- Run Time Hrs. (High): 5.5
- Beam Distance (High): 171 m
- Body Material: Plastic
- Battery Type: Rechargeable (included)
- IP Rating: 67
- Power: 120V/100V AC



Model No.	Mfg. No.	Lumens	Body Colour	Price /Each
XI455	68732	275	Yellow	155.00

STINGER® LEDS & POLYSTINGER® LEDS

- Compact, rechargeable flashlights that are not only durable, but super bright
- Charge time: 4.5 hours
- Push button switches on the head for momentary or constant "on-off" switching
- Includes a NiMH battery that is rechargeable up to 1000 times
- Optional accessories: safety wands, 5-unit bank charger, ring holder, holster, PiggyBack® charger, coloured flip lens covers
- 4 modes of lighting: High, Medium, Low or Strobe
- Features a LED that is impervious to shock and has a 50000 hour lifetime - never needs to be replaced
- Run times: **High beam** - Up to 3 continuous hours; **Medium** - Up to 5.5 continuous hours; **Low** - 10 continuous hours; **Strobe** - Up to 5.5 continuous hours
- Stinger® LED constructed of aircraft machined aluminum with polycarbonate lens
- PolyStinger® LED is constructed of super-tough non-conductive nylon polymer with a non-slip rubber grip



XC397



XC480



Model No.	Mfg. No.	Description	Lumens	Price /Each
XC397	75713	Stinger® LED	425	275.00
XC480	76163	PolyStinger® LED	485	269.00

PROPOLYMER® FLASHLIGHTS

- Waterproof, non-conductive polymer casings
- Easy to use push button momentary or constant "on-off" switching
- Batteries included
- **XC054** features super bright, 100 000 hour lifetime LEDs
- **XC056** contains a super high flux LED with a 10 000 hour lifetime
- **XC054** is CUL Listed Class I, II, Div. 2, Class III and MSHA approved
- **XC056** is CUL Listed for Class I, II, Div. 2, Class III
- **XD467** is CUL Listed for Class I, II, Div. 1, Class III and MSHA approved



Model No.	Mfg. No.	Description	Lumens	Price /Each
XC054	68202	4 AA LED, 155 Hours of Continuous Run Time	67	57.50
XC056	68244	4 AA Lux LED, Div. 2, 4 Hours with 2 Additional Hours of Declining Usable Light	100	78.90
XD467	67101	2 AA LED, HAZ-LO®, 24 Hours of Continuous Run Time	65	43.50

SURVIVOR®

- Brightest right-angle LED flashlight available
- Features a C4® LED with a 405 m. range and optimal peripheral illumination
- LED produces up to 175 lumens and has a 50 000 hour lifetime
- Raised push button switch features: High, Low, Flash and moonlight
- Run time (rechargeable): **High** 3.5 hours; **Low** 13 hours; **Flash** 5 hours; **Moonlight** 20 days
- Run time (alkaline): **High** 4 hours; **Low** 15 hours; **Flash** 8 hours; **Moonlight** 20 days
- Constructed of high-impact, super-tough nylon for durability and O-ring sealed for water-resistance
- Unbreakable polycarbonate lens with silicone anti-scratch coating
- Rechargeable models also include alkaline battery pack (alkaline batteries not included)
- Operates on 4 AA alkaline or rechargeable NiMH battery pack
- Serialized for easy identification
- UL Approved for Class I, Div. 1, Groups C, D; Class I, Div. 2, Groups A, B, C, D; Class II Div. 11, Groups F, G, Class III, T4, MSHA alkaline only



Model No.	Mfg. No.	Description	Lumens		Colour	Price /Each
			High	Low		
XC400	90513	Survivor® Rechargeable	175	60	Yellow	289.00
XC401	90503	Survivor® Rechargeable	175	60	Orange	289.00
XC402	90540	Survivor® Alkaline	175	60	Orange	135.00
XC403	90541	Survivor® Alkaline	175	60	Yellow	135.00
XC405	90542	Alkaline Battery Pack (Batteries Not Included)	-	-	-	8.69

KNUCKLEHEAD® SPOT LED FLASHLIGHTS

- Shockproof C4® premium LED technology
- Deep dish parabolic reflector produces a focused beam for longer distances: 210 m on high beam
- Durable spring-loaded clip for easy attachment to turnout gear and uneven surfaces
- Features a 210° articulating head that rotates a full 360°
- Four modes:
 - High:** 11 000-candela peak beam intensity, 180 lumens, 3.5-hour runtime
 - Low:** 3300-candela peak beam intensity, 55 lumens, 16-hour runtime
 - Moonlight:** 20-day runtime
 - Flash:** 8-hour runtime
- Dual power source: accepts rechargeable NiCad battery pack or four AA alkaline batteries
- Rubber dome push-button actuator is easy to operate even when wearing heavy gloves
- Removable magnet with 135-lb. pull strength features a replaceable rubber boot
- Optimized electronics provide regulated intensity
- High-impact, super-tough nylon polymer construction for exceptional durability
- 2-m impact-resistance tested
- IPX4-rated for water-resistance



Model No.	Mfg. No.	Description	Lumens	Price /Each
XD010	90757	Knucklehead® Spot 120 V AC/12 V DC, Orange	180	355.00
XC405	90542	Alkaline Battery Pack (Batteries Not Included)	-	8.69
XB872	EN91	Replacement Alkaline Batteries, AA, 24/Pkg.	-	18.00/Pkg.

KNUCKLEHEAD® FLOOD LED FLASHLIGHTS

- High-impact super-tough nylon offering exceptional durability
- Super-bright C4® LED is impervious to shock and has a 50 000 hour lifetime
- IPX4-rated for water resistant operations
- All openings O-ring sealed
- Full 360° rotation head with 210° of articulation
- Removable magnet with 135-lb. pull strength and integrated hook
- Lens is an unbreakable polycarbonate with silicone anti-scratch coating and is assembled in a heavy-duty bezel
- **XD862:** AC/DC - Class I, Div. 1 approved for hazardous locations
- **XD863:** Class I, Div. 1 approved for hazardous locations
- **XD863** includes 4 AA alkaline batteries
- Charger meets requirements of NFPA 1901-14.1.11.2 (2003) mounted in any position



Model No.	Mfg. No.	Battery	Lumens	Price /Each
XC767	90642	4 AA Alkaline Non-Rechargeable Battery Pack	200	199.00
XD862	91627	HAZ-LO® Rechargeable Worklight	163	369.00
XD863	91642	HAZ-LO® Worklight	163	199.00

FLASHLIGHTS

E-FLOOD® LITEBOX® RECHARGEABLE LANTERNS

- Produces up to 4000 candelas and has 615 lumens on high power
- IPX4-rated design for weather resistant operation
- Fits existing Streamlight LiteBox® racks
- Six LEDs produce a smooth flood pattern
- Battery is a zero maintenance 6 V, 12 Ah sealed lead acid and is rechargeable up to 500 times
- Red and green LEDs provide charge status
- Charge rack meets requirements of NFPA standard 1901-14.1.11.2 (2003) mounted in any position



Model No.	Mfg. No.	Colour	Lumens	Price /Each
XC757	45801	Orange	615	455.00
XC758	45821	Yellow	615	455.00

WAYPOINT® PISTOL GRIP SPOTLIGHTS

- C4® LED technology, with a 50000 hour lifetime
- Three modes of lighting: High, low and emergency signal
- IPX4 rated design for water resistant operation
- Integrated stand for hands-free scene lighting
- Unbreakable polycarbonate lens
- **XC764** and **XC765**: Powered by 4 "C" batteries (not included) or 12 V DC power cord (included)
- Run time (**XC764** and **XC765**): High 10 hrs.; 12 V DC power cord: Unlimited
- Run time (**XD331** and **XD332**): High 3.75 hrs.



Model No.	Mfg. No.	Lumens	Description	Colour	Price /Each
XC764	44900	550	Spotlight, Alkaline Batteries	Yellow	135.00
XC765	44902	550	Spotlight, Alkaline Batteries	Black	135.00
XB874	EN93	-	Replacement batteries, C-cell, 12/pkg.	-	22.56
XD331	44910	1000	Spotlight, Rechargeable	Yellow	265.00
XD332	44911	1000	Spotlight, Rechargeable	Black	265.00

FIRE VULCAN® LED

- Lightweight, waterproof lantern features super bright C4® LED technology and two blue taillight LEDs that provide illumination both in front of and behind the lantern
- C4® LED produces up to 80000 Candela (Peak Beam Intensity), is impervious to shock and has a 50000 hour lifetime
- The 2 ultra-bright blue taillight LEDs can be seen through thick smoke
- Run times: Steady LED and taillights - Up to 3 hours to the 10% output level (High) and up to 7 hours (Low)
- 8 total programmable functions - 4 functions when toggle switch in "left" position and 4 functions when toggle switch is in "right" position
- IPX7 rated design - waterproof to 1 meter for 30 minutes; lantern floats
- Raised handle and toggle "on-off" switch ensure ease of use with a gloved hand
- Super lightweight lithium ion battery recharges in 5 hours
- Includes shoulder strap, AC/DC charge cords and charging rack
- Class I, Div. 2, Groups A, B, C, D; Class II, Div. 2, Groups F, G; Class III T-Code: T4
- Rack meets requirements of NFPA standard 1901-14.1.11.2 (2003) mounted in any position



Model No.	Mfg. No.	Lumens High/Low	Price /Each
XC406	44450	145/70	415.00

E-SPOT® LITEBOX® RECHARGEABLE LANTERNS

- Uses three LEDs and deep-dish parabolic reflectors to produce a large spot pattern
- Run time: High - up to 7 continuous hours; Low - up to 15 continuous hours
- Produces up to 55000 candelas and has 540 lumens on high power
- IPX4 rated design for weather resistant operation
- Fits existing Streamlight LiteBox® racks
- Includes 6 V, 12 Ah sealed lead acid rechargeable battery; rechargeable up to 500 times
- Rack meets requirements of NFPA standard 1901-14.1.11.2 (2003) mounted in any position



Model No.	Mfg. No.	Lumens	Colour	Price /Each
XC759	45851	540	Orange	409.00
XC760	45871	540	Yellow	409.00

SIEGE® COMPACT LANTERNS

- C4 LED technology for extreme brightness
- A rugged, compact lantern
- 360° soft even lighting that illuminates a large area
- Multiple modes
- Stand it upright or to use as an overhead light hang it with the D-ring on base of lantern
- IPX7 waterproof to 1 m submersion
- 2 m impact resistance tested
- Floats so you can retrieve it if you drop it in the water
- Colour: Black/Green
- RoHS compliant
- Batteries not included



XD340



Model No.	Mfg. No.	Description	Beam Distance	Lumens High Low	Run Time Hrs. High Low	Price /Each
XD340	44931	Lantern, 3 D-Cell Batteries	200 m	540 55	30 295	90.90
XB875	EN95	Replacement D-Cell Batteries, 12/Pkg.				27.48
XE647	44941	Lantern, 3 AA-Cell Batteries	100 m	200 50	7 37	67.90
XB872	EN91	Replacement AA-Cell Batteries, 24/pkg.				18.00

PORTABLE RECHARGEABLE LED SCENE LIGHTS

- Six C4® LEDs and wide pattern parabolic reflectors produce a smooth flood pattern
- Indefinite run time with 12 V power cord
- 3 levels of lighting
- Wattage: 36 W
- Stabilization legs provide balance on uneven surfaces
- 90° swivel neck allows you to aim the beam where you need it for task lighting
- Packs to a compact size for easy storage
- Pole extends to 72"
- Weatherproof construction



Model No.	Mfg. No.	Description	Lumens	Price /Each
XE753	45670	Portable Rechargeable LED Scene Light	5300	1729.00

MAGLITE® MINI

MINI MAGLITE® AA-CELL

- High-strength aluminum alloy case
- 1/2 turn, twist focus, spot-to-flood
- Candle mode for convenient hands free light
- Spare lamp safely secured in the tail cap
- O-ring sealed for water resistance
- Super-bright Xenon Lamp™
- Includes 2 AA alkaline batteries in all package types

MINI MAGLITE® AAA-CELL

- High-strength aluminum alloy case
- Twist focus, spot-to-flood
- Spare lamp safely secured in the tail cap
- O-ring sealed for water resistance
- **XD004**: 87 lumens LED, 116 m beam distance
- Includes: Pocket clip and 2 AAA alkaline batteries

SOLITAIRE® AAA-CELL

- High-strength aluminum alloy case
- Less than 1 oz. and about 3" in length
- Spare lamp safely secured in the tail cap
- **XD003**: 37 lumens LED, 55 m beam distance
- Includes: 1 AAA alkaline battery and key lead lanyard



XA679

Model No.	Description	Lumens	Price /Each
MINI MAGLITE® AA-CELL			
XA669	Blister Pack	14	27.50
XA678	Holster Pack	14	28.50
XA679	Combo Pack	14	28.50
MINI MAGLITE® AAA-CELL & MINI MAGLITE® LED			
XA680	Blister Pack	9	24.50
XD004	LED Black, Blister Pack	87	46.50
SOLITAIRE® & SOLITAIRE® LED			
XA681	Black, Blister Pack	2	16.50
XD003	LED Black, Blister Pack	37	39.90
REPLACEMENT BULBS			
XA701	Solitaire® Replacement Bulb	-	6.09
XA703	Replacement Bulb, fits AA and AAA	-	5.79

MAGLITE® D-CELL

- Cam driven beam changes from flood to spot with a turn of the head
- Anodized aircraft aluminum with knurled grip enhances conductivity, increases durability, reduces oxidation and battery damage
- White Star krypton lamp provides 70% more light than a standard PR2 lamp
- Spare krypton lamp included in tail cap
- Rubber O-rings ensure resistance to water and shock
- Batteries not included

XA385



Model No.	Mfg. No.	Description	Lumens	Price /Each
XA384	S2D016	2 D-Cell Flashlight	27	68.50
XA385	S3D016	3 D-Cell Flashlight	45	71.50
XA386	S4D016	4 D-Cell Flashlight	98	72.90
REPLACEMENT BULBS				
XC955	LMXA201	Bi-Pin Xenon Bulb for 2 Cell	-	9.19
XC956	LMXA201	Bi-Pin Xenon Bulb for 3 Cell	-	9.19
XC940	LMXA401	Bi-Pin Xenon Bulb for 4 Cell	-	9.39
BATTERIES				
XB875	EN95	Replacement D-Cell Batteries, 12/Pkg.	-	27.48

MAGLITE® FLASHLIGHT ACCESSORIES



Model No.	Description	Price /Each
XB344	Belt Holster, Black Leather for 2 AA-Cell	23.50
XB345	Belt Holster, Black Nylon for 2 AA-Cell	10.50
XC386	Belt Holster, Camouflage Nylon for 2 AA-Cell	10.50
XB347	Belt Holster for D-Cell	17.90
XC080	Rubber Anti-Roll Device/Lens Holder; Red, Clear and Blue Lenses; 2 D-Cell Mounting Brackets for D-Cell	24.50
XC081	Red, Blue and Clear Lenses; Anti-Roll Device/Lens Holder; Wrist Lanyard; Pocket Clip for 2 AA-Cell	11.90
TRAFFIC WAND KITS W/REFLECTIVE TAPE		
XC082	Red, for C-Cell and D-Cell only	24.50
XC083	Yellow, for C-Cell and D-Cell only	24.50
XC084	White, for C-Cell and D-Cell only	24.50

MAGLITE® LED D-CELL FLASHLIGHTS

- Balanced Optics™ combines a highly refined reflector with a performance enhanced LED, for a brilliant adjustable beam
- Intelligent Energy Source Management balances high brightness with extended battery life
- Powerful projecting LED beam that focuses spot to flood simply by rotating the head
- Rugged, machined aluminium construction with knurled design
- Anodized inside and out for improved corrosion resistance
- Water and shock resistant
- Batteries not included
- Beam Distance: 412 m



MAGLITE® LED

Model No.	Mfg. No.	Description	Lumens	Run Time hrs.	Price /Each
XC239	ST2D016	2 D-Cell Flashlight	168	6.75	98.50
XB875	EN95	Replacement D-Cell Batteries, 12/Pkg.			27.48

FLASHLIGHTS



MAGLITE® XL50™ LED FLASHLIGHTS

Delivers user-friendly, performance-oriented features in a sleek, tactical design and is driven by the next generation of Mag-LED™ technology.

FEATURES:

- 213 m powerful projecting LED beam
- 200 lumens
- "Spot-to-Flood" adjustable LED beam
- Push button tail-cap switch
- Compact, pocket size design
- Anodized for corrosion resistance and durability
- Rugged, machined aluminum body
- Intelligent Energy Source Management - continuously monitors the balance between high brightness and efficient power usage allowing for prolonged battery life

XC841



3 QUICK-CLICK SELECTABLE MODES:

- 1 Quick-click turns unit "ON" at high power
- 2 Quick clicks = Energy savings on at 25% power
- 3 Quick clicks = Emergency safety strobe
- Powered by three AAA alkaline batteries (included)

SPECIFICATIONS:

- Length: 4.8" (121.92 mm)
- Barrel diameter: 1" (25.4 mm)
- Head diameter: 1" (25.4 mm)
- Weight with batteries: 3.68 oz. (104 g)



XC843

BELT HOLSTERS FOR XL SERIES™ FLASHLIGHTS

- Rugged woven ballistic nylon
- Weather-resistant lock-stitched thread
- Click-adjustable rotating belt clip
- Accepts belts up to 1 5/8" wide
- Flashlight can be aimed while holstered
- Allows hands-free operation

MAGLITE® XL200™ LED FLASHLIGHTS

The XL200™ offers five basic, easy to use functions and advanced features and brightness of a next-generation LED.

The simple "Quick-Click" method let's the user select the desired function with motion-controlled variable power level and blink rate.

FEATURES:

- 224 m powerful projecting LED beam
- 172 lumens
- "Spot-to-Flood" adjustable LED beam
- Push button tail-cap switch
- Anodized for corrosion resistance and durability
- Rugged, machined aluminum body
- Sealed at both ends with high-grade rubber O-rings and lip seals

5 QUICK-CLICK SELECTABLE MODES:

- 1 Quick-click turns unit "ON" at high power
- 2 Quick-clicks = Emergency safety strobe
- 3 Quick-clicks = Nite Lite™ mode
- 4 Quick-clicks = Signal mode
- 5 Quick-clicks = SOS mode
- Powered by three AAA alkaline batteries (included)

SPECIFICATIONS:

- Length: 4.8" (121.92 mm)
- Barrel diameter: 1" (25.4 mm)
- Head diameter: 1" (25.4 mm)
- Weight with batteries: 3.68 oz. (104 g)



XC842

MAGLITE® LED

Model No.	Mfg. No.	Description	Lumens	Price /Each
XC841	XL50-S3016	3 Mode, AAA, LED	200	105.00
XC842	XL200-S3016	5 Mode, AAA, LED	172	129.00
XC843	XLXXX-A3046	Belt Holster	-	29.50
XB873	EN92	Replacement Batteries, AAA, 24/Pkg.	-	18.48

MINI MAGLITE® LED & PRO™

- Powerful projecting LED beam that focuses simply by rotating the head
- Balanced Optics™ combines a highly refined reflector with a performance enhanced LED yielding high output intensity
- Intelligent Energy Source Management allows the user choose the power level
- Multi-mode electronic switch: 100% power, 25% power, blink, SOS (XC238 only)
- Length: 6.6"
- Maglite® Pro™ offers latest generation LED
- Includes: 2 AA size alkaline batteries and belt holster

XC814



ML150LR(X) FAST-CHARGING FLASHLIGHT

- Recharge to 80% in a half hour
- Matte anodized finish
- Individually serial numbered
- The pair of bands encircling the barrel of the Mag Charger flashlight is a trademark of Mag Instrument
- Lamp Type: LED
- Run Time Hrs. (High): 3.25
- Run Time Hrs. (Low): 79
- Beam Distance (High): 458 m
- Body Material: Aluminum
- Body Colour: Black
- Battery Type: Rechargeable (included)
- Water Resistant: IPX4
- Drop Resistance: 1
- Barrel Diameter: 1.187" / 30.15 mm
- Head Diameter: 1.937" / 49.12 mm
- Weight with Batteries: 15.2 oz./431 g



MAGLITE® LED

Model No.	Mfg. No.	Description	Lumens	Price /Each
XC238	SP2201H	Mini Maglite® LED Flashlight, 2 AA-Cell	97	63.90
XC814	SP2P01H	Mini Maglite® LED Pro™ Flashlight, 2 AA-Cell	332	73.90
BATTERIES				
XB872	EN91	Replacement Batteries, AA, 24/Pkg.	-	18.00



Model No.	Mfg. No.	Lumens High/Low	Price /Each
XI768	ML150LR-1019	1082/138	319.00



9050 HIGH-PERFORMANCE LANTERN FLASHLIGHT

- Flexible battery system allows you to select between Li-ion, AA alkaline or AA NiMH to operate the light
- Four battery slots let you maximize runtime
- Quick-change battery system means that you have continuous lighting to get the job done
- Select between spot, flood, spot/flood, or flashing modes to find the right beam for your job
- Spot/flood light head outputs up to 3369 lumens without the need for diffusers or attachments, so you can quickly choose the right beam type for your job
- Redesigned charger base makes mounting and dismantling the lantern quick and easy
- Rear taillights with adjustable colors make notification or identification as simple as pressing the dedicated switch
- Features glove-friendly switch activation, wide base for stability, and battery status indicator switch
- Lamp Type: LED
- Lumens (High): 3369
- Run Time Hrs. (High): 2.75
- Body Material: Plastic
- Battery Type: AA, Rechargeable
- Body Colour: Yellow
- Beam Distance (High): 489 m
- Batteries Included
- Limited Lifetime Warranty
- Length: 8.03" (20.4 cm)
- Switch Type: Push Button
- Voltage: 7.4 V
- Charge Time: 5.5 hrs.
- Lamp Life: 50000 hrs.
- Standards: NFPA 1901 Approved



Model No. XJ141
Mfg. No. 090500-0000-245
Price/Each \$619.00

VULCAN CLUTCH® MULTI-FUNCTION LANTERN

- Lantern housing is made from high-impact, super tough nylon offering exceptional durability.
- Three white LEDs are impervious to shock with a 50000 hour lifetime
- Two ultra bright blue taillight LEDs ensure you can be seen even from behind
- Three deep-dish parabolic reflectors produce a tight beam with optimum peripheral
- Optimized electronics provide regulated intensity
- Large, multi-function, push-button switch on top of light is easy to use with gloves
- Programmable tail light mode; flashing (factory default), on or off
- Features a versatile clamping handle, 340° rotating head with hinges at the top, providing multi-directional lighting, 20° downcast head for footpath lighting, and a battery status indicator
- Lumens (High): 1700
- Run Time Hrs. (High): 6.5
- Beam Distance (High): 520 m
- 9.39" (23.85 cm) L x 4.6" (11.68 cm) x 6.4" (16.26 cm)
- Weight: 2.84 lbs. (1288 g)
- Charge Time: 5 hr
- Standard(s) Met: NFPA 1901-14.1.10.2 (2016)
- Limited Lifetime Warranty
- Voltage: 120 V



XJ178



Model No.	Mfg. No.	Body Colour	Includes	Price /Each
XJ178	44361	Orange	(1) Vulcan Clutch® Lantern, (1) Quick-Release Strap, (1) Lithium-Ion Battery, (1) Charging Rack, (1) 100V/120V AC Charge Cord	399.00
XJ179	44371	Yellow	(1) Vulcan Clutch® Lantern, (1) Heavy-Duty Strap, (1) Lithium-Ion Battery, (1) Charging Rack, (1) 100V/120V AC Charge Cord	389.00
XJ180	44365	Orange	(1) Vulcan Clutch® Lantern, (1) Quick-Release Strap, (1) Lithium-Ion Battery, (1) 12V DC Vehicle-Mountable Direct Wire Charging Rack	379.00
XJ181	44375	Yellow	(1) Vulcan Clutch® Lantern, (1) Heavy-Duty Strap, (1) Lithium-Ion Battery, (1) 12V DC Vehicle-Mountable Direct Wire Charging Rack	369.00
XJ182	44360	Orange	(1) Vulcan Clutch® Lantern, (1) Quick-Release Strap, (1) Lithium-Ion Battery	339.00
XJ183	44370	Yellow	(1) Vulcan Clutch® Lantern, (1) Heavy-Duty Strap, (1) Lithium-Ion Battery	329.00

HEADLAMP

- Emits a light of 350 lumens on high for up to 2 hours, and 15 hours when set to low at 40 lumens
- IPX7 Waterproof rating (1m, 30min)
- Battery charge light indicator on the side
- 2m impact resistance
- Adjustable headband
- Includes: Headlamp, Micro-USB recharging cable, Helmet clips
- Lamp Type: LED
- Lamp Material: Rubber
- Body Colour: Black
- Beam Distance (High): 110 m
- Light Colour: White

Model No. X1801
Price/Each \$26.35



PROTAC® 2.0 HEADLAMP

- Uses one (1) Streamlight SL-B50® protected Li-Ion USB-rechargeable battery pack (included)
- Ten-Tap® Programmable switch for user selectable operation of three operating modes (high/low, high only, and low/medium/high)
- IP67-rated; dust-tight and waterproof to 2 meters; 2-meter impact resistance tested
- 6000 series machined aircraft aluminum with Type II MIL-Spec anodized finish
- Includes: ProTac® 2.0 Headlamp, SL-B50® Battery pack, USB-C cord, Rubber & elastic head straps
- Lumens (High): 2000
- Run Time Hrs. (High): 2.25
- Lamp Material: Aluminum
- Body Colour: Black
- Beam Distance (High): 241 m
- Beam Distance (Medium): 130 m
- Lumens (Medium): 650 Lumens
- Run Time Hrs. (Medium): 4.5
- Beam Distance (Low): 55 m
- Lumens (Low): 110 Lumens
- Run Time Hrs. (Low): 25
- Weight (with Battery): 10.48 oz.
- Manufacturer's Warranty: Limited Lifetime

Model No. XJ112
Mfg. No. 89001
Price/Each \$245.00



FLASHLIGHTS

CREE® HEADLAMPS

- Head angle is adjustable
- Adjustable in/out zoom
- Water resistant
- 3 settings: High, Low and Strobe
- Batteries Required: 3 AAA
- Run Time Hrs. (High): 6
- Run Time Hrs. (Low): 20
- Beam Distance (High): 120 m
- Batteries not included



AURORA
TOOLS

Model No.	Lumens High/Low	Price /Each
XE887	120/30	28.50

HEADLAMP

- 7 ultra bright LED lights
- 3 brightness levels - 7 LEDs, 3 LEDs, 1 LED
- Water resistant
- Lightweight design
- Tilting head and adjustable head strap
- Batteries Required: 3 AAA
- Lamp Type: LED
- Battery Type: AAA
- Body Colour: Silver
- Beam Distance (High): 10 m
- Batteries Included/ Not Included: Not Included
- Light Colour: White



AURORA
TOOLS

Model No.	Lumens	Price /Price
XC658	21	11.50

HARDCASE RUGGED LED HEADLAMPS

- Rugged LED headlamp with rear-mounted battery pack
- Multiple lighting modes (spot/flood, high/low)
- Includes 3 AA Energizer® MAX® batteries
- Run Time Hrs. (High): 6.5
- Lamp Colour: Black
- Beam Distance (High): 100 m
- Water Resistance: IPX4



Energizer

Model No.	Mfg. No.	Lumens	Price /Each
XC679	TUFHD31PE	325	48.50

FL19 FLOOD BEAM HEADLAMPS

- Wide Angle Flood Beam illuminates the broadest possible area - at 6 ft. (1.8 m), the beam shines a clear circle up to 11.5 ft. (3.5 m) in diameter
- Features a dual-colour function; all-white utility beam for general use, and a red, anti-glare beam that prevents "night blinding"
- Features an emergency signaling tool
- Hardhat compatible
- Dual power function to save battery
- Features a hinged, tilting head
- Water resistant
- Reflective strap increases safety and ensures visibility in low light
- Runs on 3 x AAA
- Lamp Material: Aluminum
- Body Colour: Black
- Lamp Type: LED
- Run Time Hrs. (High): 3.25
- Run Time Hrs. (Low): 17
- Beam Distance (High): 38 m
- Beam Distance (Low): 15 m
- Batteries included
- Light Colour: White
- Battery Location: Front
- Weight: 85 g



COAST

Model No.	Mfg. No.	Lumens High/Low	Price /Each
XI138	21679	330/45	32.89

HD VISION INDUSTRIAL HEADLAMPS

- Dimmable to control brightness and runtime
- Pivots to direct light where you need it
- Includes 3AAA Energizer® MAX® batteries
- Lamp Type: LED
- Lamp Material: Plastic
- Run Time Hrs. (High): 4.33
- Beam Distance (High): 55 m
- Batteries included
- Three light modes: White spot light, White flood light and Spot and flood together



Energizer

Model No.	Mfg. No.	Lumens	Price /Each
SDM001	HDBIN32E	300	26.71

FL85 HEADLAMPS

- Hinged beam allows for quick and easy light beam adjustment
- Hardhat compatible
- Dual colour mode allows for great visibility in low light situations and offers bright, long distance illumination
- Reflective strap provides additional visibility on low lighting
- IPX4 weatherproof rating
- Lamp Type: LED
- Lamp Material: Plastic
- Run Time Hrs. (High): 2.25
- Run Time Hrs. (Low): 13
- Battery Type: AAA
- Body Colour: Black
- Beam Distance (High): 183 m
- Beam Distance (Low): 77 m
- Batteries included
- Light Colour: Red, White
- Dual Colour Mode: Red and White Beam
- Beam Optic: Pure Beam



COAST

Model No.	Mfg. No.	Lumens High/Low	Price /Each
XE988	21190	615/96	70.89

HL7 HEADLAMP

- Hinged beam allows for quick and easy light beam adjustment
- Hardhat compatible
- Tested and rated to ANSI/FL1 standards
- Lamp Type: LED
- Lamp Material: Plastic
- Body Colour: Black
- Run Time Hrs. (High): 1.5
- Run Time Hrs. (Low): 70
- Beam Distance (High): 119 m
- Beam Distance (Low): 13 m
- Battery Type: AAA
- Batteries included
- Light Colour: White
- Modes: High to Low
- Beam Optic: Pure Beam



COAST

Model No.	Mfg. No.	Lumens High/Low	Price /Each
XF008	TT7497CPBL-P2	285/4	67.69

2720 HEADLAMPS

- Features gesture activation control
- Can be operated in high, signaling, or night vision red LED mode
- Rubber head strap included
- Optical 4x magnification allows for a wide or penetrating beam
- Lamp Type: LED
- Run Time Hrs. (High): 2.3
- Beam Distance (High): 82 m
- Batteries included
- Number of Batteries Required: 3 AAA
- Water Resistance: IPX4



PELICAN

Model No.	Mfg. No.	Lumens	Price /Each
XE236	027200-0101-110	200	93.50

ENDURO® LED HEADLAMPS

- Solid State Power Regulator provides maximum light output throughout battery life
- Waterproof to 1 metre for 30 min.
- Includes rubber/elastic combo head strap
- Run Time Hrs. (High): 5.5
- Battery Type: AAA
- Lamp Colour: Black
- Beam Distance (High): 66 m
- Number Of Batteries Required: 2



STREAMLIGHT

Model No.	Mfg. No.	Lumens	Price /Each
XD434	61400	14.5	30.90

2755 HEADLAMPS

- Safety approved headlamp designed for use in hazardous environments
- Ultra compact and lightweight
- Class I - Division 1 approved
- Equipped with a low battery indicator
- Can be operated in high, low, or flashing mode
- Lamp Type: LED
- Lamp Material: Plastic
- Run Time Hrs. (High): 6
- Run Time Hrs. (Low): 15 hrs.
- Beam Distance (High): 57 m
- Beam Distance (Low): 40 m
- Peak Beam Intensity (High): 807 cd
- Peak Beam Intensity (Low): 404 cd
- Battery Type: AAA
- Batteries included
- Light Colour: White
- No. of Batteries Required: 3
- Length: 2.25"
- Weight With Batteries: 3.4 oz.
- Water Resistance: IPX4



PELICAN

Model No.	Mfg. No.	Lumens High/Low	Colour	Price /Each
XE901	027550-0103-110	72/34	Black	60.50
XE902	027550-0103-245	72/34	Yellow	60.50

2750 HEADLAMPS

- Bright and compact headlamp that features a night vision friendly red LED
- Designed with weather resistant casing which allows for fast and easy battery change
- Can be operated in high, low, or flashing mode
- Lamp Type: LED
- Run Time Hrs. (High): 2.30
- Beam Distance (High): 90 m
- Beam Distance (Low): 48 m
- Batteries Included
- Number of Batteries Required: 3 AAA
- Water Resistance: IPX4



PELICAN

Model No.	Mfg. No.	Lumens High/Low	Colour	Price /Each
XE232	027500-0102-110	259/71	Black	53.50
XE900	027500-0102-247	259/71	Photoluminescent	53.50

2765 HEADLAMPS

- Safety approved headlamp designed for use in hazardous environments
- Ultra compact and lightweight
- Class I - Division 1 approved
- Can be operated in high, low, downcast, or flashing mode
- Lamp Type: LED
- Run Time Hrs. (High): 6.25
- Beam Distance (High): 81 m
- Lumens (Main & Downcast High): 132
- Lumens (Main & Downcast Low): 78
- Lumens (Downcast): 34
- Run Time Hrs. (Downcast): 14
- Beam Distance (Downcast): 10 m
- Batteries included
- Number of Batteries Required: 3 AAA
- Water Resistance: IPX4



PELICAN

Model No.	Mfg. No.	Lumens	Colour	Price /Each
XE905	027650-0100-110	155	Black	75.50
XE906	027650-0100-245	155	Yellow	75.50

BATTERIES

ENERGIZER® BATTERIES

ALKALINE



XB872



XB875



XB876



XC001

SILVER OXIDE



XB992



XB994

LITHIUM



XC015



XC013



XC007



XC008



XE736

GARAGE DOOR



XB995

NIMH RECHARGEABLE



XC017



XC016



XC019



XC018

Energizer

Model No.	Mfg. No.	Description	Qty /Pkg.	Price /Package
ALKALINE INDUSTRIAL				
XB873	EN92	AAA/1.5 V	24	18.48
XB872	EN91	AA/1.5 V	24	18.00
XB874	EN93	C/1.5 V	12	22.56
XB875	EN95	D/1.5 V	12	27.48
XB876	EN22	9 V	12	34.80
ALKALINE				
XC001	E96BP2	AAAA/1.5 V E2	2	9.34
XA430	529	Lantern, 6 V, Spring	1	19.50
XH110	A76BP2	1.5 V, Coin	2	1.79
SILVER OXIDE				
XB992	357BP	1.5 V, 11,6 mm x 5,4 mm	1	2.60
XB993	377BP	1.5 V, 6,8 mm x 2,6 mm	1	4.56
XB994	392BP2	1.5 V, 7,9 mm x 3,6 mm	1	3.52
LITHIUM				
XC002	ECR2016BP	Coin Type, 3 V, CR2016	1	2.79
XC003	ECR2025BP	Coin Type, 3 V, CR2025	1	4.98
XC004	ECR2032BP	Coin Type, 3 V, CR2032	1	2.46
XC005	ECR2450BP	Coin Type, 3 V, CR2450	1	6.69
XC006	EL123APBP	Photo, 3 V, 123	1	6.17
XC007	EL1CR2BP	Photo, 3 V, 1CR	1	5.81
XC009	EL2CR5BP	Photo, 6 V, 2CR5	1	22.42
XE736	LS22BP	9 V	1	26.65
XC013	L91BP4	AA/1.5 V	4	25.42
NK1125	L91	AA/1.5 V	24	122.40
XC015	L92BP2	AAA/1.5 V	2	14.00
NIMH RECHARGEABLE				
XC016	NH12BP2	AAA	2	21.60
XC017	NH15BP4	AA	4	36.10
XC018	NH22NBP	9 V	1	23.54
XC019	NH35BP2	C	2	27.00
XC020	NH50BP2	D	2	27.00
GARAGE DOOR				
XB995	A23BP	12 V	1	4.86

ALKALINE BATTERIES

- Mercury-free
- Cadmium-free
- Aluminium jacket
- 7 Year shelf life



X1880



X1879

XJ222



XJ221

AURORA TOOLS

Model No.	Description	Qty /Pkg.	Price /Package
X1880	AAA/1.5 V	24	8.88
X1879	AA/1.5 V	24	11.28
XJ220	C/1.5 V	4	4.80
XJ221	D/1.5 V	4	6.75
XJ222	9 V	12	22.80

ANALOG BATTERY TESTER

- Compatible with the majority of standard household batteries
- Analog scale displays the capacity of the battery instantly (Replace, Low, Good)
- No batteries required to operate
- Battery Type(s): AAA, AA, C, D, 9V

Model No. XF613
Price/Each \$9.50

AURORA TOOLS



ULTRA PRO™ ALKALINE INDUSTRIAL BATTERIES

- Reclosable container helps organize and protect batteries from damage
- 10-year power guarantee in storage
- Voltage: 1.5 V

XG845



RAYOVAC

Model No.	Mfg. No.	Battery Type	Qty /Pkg.	Price /Package
XG845	ALAA-24PPJ	AA	24	21.60
XG844	ALAA-18J	AAA	18	26.12

BATTERY CHARGERS

XE457

- Charges: AA, AAA
- Includes: (4) AA NiMH batteries
- Ideal for travelling and digital cameras
- Auto shut off
- Energy Star

XD021

- Charges two or four AA or AAA NiMH rechargeable batteries
- Easy-to-read charge status indicators
- Fold-out plug for easy storage
- Includes: (2) AA NiMH batteries



XE457

XD021

Energizer

Model No.	Mfg. No.	Description	Charge Time	Price /Each
XE457	CHPROWB4	Overnight, Compact Charger	2 or 4 AA - 3 hours 2 or 4 AAA - 3 hours	47.13
XD021	CHVCWB2	Basic Charger	2 or 4 AA - 12 to 14 hours 2 or 4 AAA - 6 to 9 hours	27.08

HEAVY-DUTY LED WORK LIGHT

- Virtually indestructible with a polycarbonate lens and rubber handle
- 50000 hour LED technology means never having to change a bulb again
- Has the same usable light output as a 13 W fluorescent work light
- Also operates as a flashlight with a 1 W LED light on the end
- Standard with 25' of 18/2 SJTOW cord
- Also available on a 40' cord reel
- Certified for sale in Canada by an accredited certification body
- Reduces energy consumption
- Lumens: 480
- Cable Length : 25

Model No. XD047
Mfg. No. LE1725LED
Price/Each \$305.00



LIND  EQUIPMENT

HAZARDOUS LOCATION HANDLAMPS

- Explosion proof LED provides 800 lumens of light output, equivalent to a 60 W bulb
- 16/3 SOOW cord with a non-explosion proof plug (explosion proof plug is also available)
- Approved for Class I Division I Group C and D hazardous locations
- Certified for sale in Canada by an accredited certification body
- Lamp Type: LED
- Wattage: 9 W
- Housing Material: Aluminum



XA269

LIND  EQUIPMENT

Model No.	Lumens	Cord Length'	Price /Each
XA269	800	25	1305.00
XA103	800	50	1225.00
XD059	800	100	1465.00

HAZARDOUS LOCATION HANDLAMPS

COMPACT FLUORESCENT HAND LAMPS

- 26-W quad tube (1800 lumens)
- Minimal heat generation makes them ideal for use in confined, potentially explosive areas
- DuPont Zytel® outer construction is extremely rugged and leaves no exposed metal parts
- 16/3 SOOW cord with a non-explosion proof plug (explosion proof plug is also available)
- Approved for Class I Division 1 Group C and D and Class II Division 1 Group F and G hazardous locations
- Certified for sale in Canada by an accredited certification body

LIND  EQUIPMENT



Model No.	Description	Price /Each
XA137	26 W, 25' Cord	1559.00
XA136	26 W, 50' Cord	1599.00
XD060	26 W, 100' Cord	1725.00
XD061	Replacement Bulb 26 W Quad Tube	30.50

EXPLOSION PROOF FLOODLIGHT WITH STAND

LIND  EQUIPMENT

- The light comes standard with a 50' cord and a non-XP plug
- Easily portable
- LEDs will last over 50000 hours
- No bulb replacement required
- Instant start-up, at full output, even in cold temperatures
- Rugged heavy duty frame
- Reduces energy consumption
- Lumens: 5600
- Wattage: 40 W
- Housing Material: Aluminum

Model No. XJ040
Mfg. No. XP970LED-FS
Price/Each \$1985.00



VALUELED™ CCT SELECTABLE SMALL WALL PACK

- Environmentally preferable LED alternatives to traditional HID luminaires, offering up to 68% in energy savings
- Ideal in place of traditional luminaires, or as new installations, for illuminating building exteriors, outdoor corridors, walkways, and stairwells
- CCT Selectable (3000K, 4000K, or 5000K) enabled through switch located inside fixture
- IP65 and IK08 rated body with aluminum backplate and polycarbonate lens offers easy mounting, reducing installation and maintenance costs
- DLC listing ensure energy efficiency and provide uniform and even lighting
- Photosensor included provides additional energy savings
- Non-cutoff distribution
- Voltage: 120 - 277 V
- Wattage: 20 W
- Overall Dim.: 6.9" W x 5.2" D x 11" H
- CRI: >70
- Total Fixture Lumens: 2400
- LPW: 120
- Rated Life: 150000 Hours
- Operating Temperature: -40°F to +104°F (-40°C to +40°C)
- Manufacturer's Warranty: 5 Years



Model No. XJ066
Mfg. No. 61750-594312414
Price/Each \$235.00

SYLVANIA



Maintain the ideal temperature in your workplace



TASK & WORK LIGHTING

INDUSTRIAL TROUBLE LIGHTS

- 75 watts
- Lightweight design
- Rugged impact resistant housing
- Grounded 25' cord
- On/Off switch handle
- **Includes:** Hanging hook and electric outlet
- Certified for sale in Canada by an accredited certification body

Model No. XC660
Price/Each \$29.95

AURORA
TOOLS



PORTABLE LED WORK LIGHTS

- Adjustable tilting head
- LED bulb included
- Certified for sale in Canada by an accredited certification body
- Lumens: 2500
- Wattage: 20
- Housing Material: Aluminum
- IP65 rating for weather and dust resistance

AURORA
TOOLS

Model No.	Price/Each
XG816	75.95



TWIN-HEAD LED WORK LIGHTS

- Adjustable tripod for desired height
- Extendable tripod legs provide greater stability
- LED bulbs included
- Fixtures can adjust 120°
- Certified for sale in Canada by an accredited certification body
- Lumens: 4800
- Wattage: 40
- Housing Material: Aluminum
- IP65 rating for weather and dust resistance

AURORA
TOOLS

Model No.	Price/Each
XG817	185.00



BEACON INFINITY LIGHTS WITH MAGNETIC MOUNT

- Compact & easily transportable
- LED bulb will last over 50,000 hours
- No bulb replacement is required
- Instant start-up at full output, even in cold temperatures
- Lamp Type: LED
- Lumens: 5400
- Wattage: 40 W
- Housing Material: Aluminum/Plastic
- Voltage: 90 - 277 V
- Weatherproof Rating: IP65

LIND **E** EQUIPMENT

Model No.	Description	Price /Each
XI026	Floor Stand	459.00
XI027	Tripod	495.00
XI028	Dual Tripod	929.00



BEACON360 GO PORTABLE WORK LIGHT WITH FLOOR STAND

- Battery operated
- Three light modes to tailor to your application
- Highest power mode provides 6000 lumens of bright white light for up to 4 hours
- The low power mode provides 3000 lumens for 8 hours
- The power saver mode provides 900 lumens for 25 hours
- The floor stand provides a super compact and portable solution
- Reduces energy consumption
- Wattage: 45 W
- Housing Material: Aluminum
- Battery: Lithium Ion
- Charge Time: 4-5 hours
- Light Temperature: 4500K
- Environmental Rating: IP65 Weatherproof

Model No. XH879
Mfg. No. LE360LEDC-FS
Price/Each \$679.00

LIND **E** EQUIPMENT



9460 REMOTE AREA LIGHTING SYSTEMS

- Features dual telescoping LED light heads with 10 LEDs per head
- Includes 12V sealed rechargeable battery with a battery level indicator
- Housed in a Pelican(TM) Protector Case(TM) housing
- Bluetooth technology remote activation which allows varied light output from 0-100%
- Certified for sale in Canada by an accredited certification body
- Lamp Type: LED
- Lumens: 12000
- Housing Material: Plastic
- Batteries Required: Rechargeable
- Colour: Black
- Beam Spread: 120°
- Run Time Hrs. (High): 3
- Run Time Hrs. (Low): 24
- Battery Charge Time: 8 hrs.

PELICAN™

Model No.	Price /Each
XC818	4259.00



9480 REMOTE AREA LIGHTING SYSTEMS

- Lighting system with 3 preset output levels (1000, 3000 or 4000 lumens)
- Includes a mast with an extended height of 23.75" and 340° rotation
- Very versatile system with multiple deployment positions
- Maintenance free LED array with 50000 hour life expectancy
- Includes a convenient shoulder strap
- Uses a 12 V rechargeable Sealed Lead Acid (SLA) battery
- Battery lasts between 6 and 28 hours depending on which output level is used
- Lighting range is highly variable and depends on the system's set-up
- Lamp Type: High Flux LED
- Wattage: 41.1 W
- Lamp Life: 50000 hrs.
- Housing Material: Polypropylene
- Certified for sale in Canada by an accredited certification body

PELICAN™

Model No.	Price /Each
XE696	1679.00



TWIN-HEAD HALOGEN WORK LIGHTS

- Twin 500-watt halogen lights
- Heat resistant tempered glass face
- Colour: Black and yellow
- Halogen bulbs included
- IP54 rating for weather and dust resistance
- Certified for sale in Canada by an accredited certification body
- Lumens: 16000

Model No. XC950
Price/Each \$109.00

REPLACEMENT BULB

Model No. XC951
Price/Each \$1.90



AURORA
TOOLS

PORTABLE HALOGEN WORK LIGHTS

- 500-watt halogen work light
- Heat resistant tempered glass face
- Adjustable tilting head
- Colour: Black and yellow
- Halogen bulb included
- IP54 rating for weather and dust resistance
- Certified for sale in Canada by an accredited certification body
- Lumens: 8000

Model No. XC949
Price/Each \$35.95

REPLACEMENT BULB

Model No. XC951
Price/Each \$1.90



AURORA
TOOLS

TWIN WORK LIGHT WITH TRIPOD

- LED last longer and consume less energy
- Stays cool to the touch even after hours of usage
- Impact resistant glass and durable aluminum housing
- Weather-protected sealed switch
- Pivot and lock LED work light at desired angle
- Non-slip soft grip carry handle
- For indoor and outdoor use in dry locations
- Height adjustable tripod with quick release latch for detaching twin LED work light assembly
- Lumens: 8000
- Wattage: 72 W
- Cord Length: 8'
- LED Life: 30000 Hours
- Dimensions: 36-1/2" L x 35-1/2" W x 81-1/2" H
- Working Temperature: 0 - 50°C

Model No. XI918
Mfg. No. KC-4002LED-ST
Price/Each \$301.00

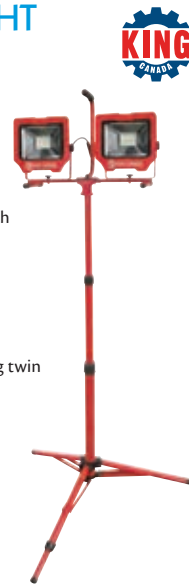

LED STRING WORK LIGHTS

- Each panel light outputs up to 1000 lumens
- LED bulbs built-in, no replacement bulbs required
- The integrated LED lights are designed to last for 30,000 hours
- Low power consumption allows 12 additional sets to be linked together
- Ideal for construction sites, indoor & outdoor use
- Comes with optional carabiners
- Wire Gauge: 16/2
- Number of Lights: 5
- Light Temperature: 5000K
- Environmental Rating: IP55
- Wattage Per Panel: 10W
- Lumens Per Panel: 1000
- Distance Between Panels: 8-5/6'



AURORA
TOOLS

Model No.	Cord Length'	Housing Material	Price /Each
XI021	50	Plastic	139.00

CORDLESS WORK LIGHT

- 3 light intensity settings (high/medium/low) and flashing setting
- 7.4 V, 2600 mAh Lithium-ion battery
- LED last longer and consume less energy
- Stays cool to the touch even after hours of usage
- Impact resistant glass and durable aluminum housing
- Weather-protected sealed switch
- Pivot and lock LED work light at desired angle
- Non-slip soft grip carry handle
- For indoor and outdoor use in dry locations
- Lumens: 1500
- Wattage: 15 W
- Battery Type: Lithium-Ion
- LED Life: 30000 Hours
- Dimensions: 6-1/2" L x 6" W x 10-3/4" H

Model No. XI915
Mfg. No. KC-1502LED-C
Price/Each \$84.00



HEAVY-DUTY MOULDED LED STRINGLIGHTS

- For tough, temporary lighting
- Hanging holes on each socket allows installation with either spikes or S-hooks
- Each socket is spaced 10 feet apart



XI324



XH875

LINDE EQUIPMENT

Model No.	Mfg. No.	Cord Length'	No. of Sockets	Housing Material	Cable	Connector	Price /Each
STRINGLIGHTS ONLY							
XH644	TLS-100CG14	100	10	Plastic	14/2 SJTOW	No	159.00
XH643	TLS-50SJ14	50	5	Plastic	14/3 SJTOW	Yes	119.00
XI325	TLS-100SJ14	100	10	Plastic	14/3 SJTOW	Yes	199.00
XI324	TLS-50MGSJ14	50	5	Metal	14/3 SJTOW	Yes	129.00
XI312	TLS-100MGSJ14	100	10	Metal	14/3 SJTOW	Yes	249.00
STRINGLIGHTS WITH LED LAMP							
XH876	TLS-50SJ14LED	50	5	Plastic	14/3 SJTOW	Yes	179.00
XH875	TLS-100SJ14LED	100	10	Plastic	14/3 SJTOW	Yes	309.00

BEACON LIGHT 40W LED FLOODLIGHTS

- As bright as a 500 W quartz-halogen floodlight
- Low operating temperature, resulting in a safer working environment
- Low energy usage and no bulb replacement, resulting in large total cost of ownership savings
- High quality LEDs are rated for over 50,000 hours
- Durable aluminum housing and tempered glass lens
- 15' 18/3 SJOW cord
- IP65 environmental rating and starts instantly in cold weather
- Certified for sale in Canada by an accredited certification body
- Lamp Type: LED
- Lumens: 6000
- Wattage: 40 W
- Housing Material: Aluminum



LIND **E** EQUIPMENT

Model No.	Description	Price /Each
XD046	Beacon Light with Clamp Mount	419.00
XC942	Beacon Light with Floor Stand	399.00

BEACON 360° WIDE AREA LED LIGHT

- Light temperature: 4500K (bright white light - no blue tint)
- 13 000 lumens equivalent usable light of a 400 W metal halide
- Environmental rating: IP64 (weatherproof)
- Construction: Cast aluminum housing, polycarbonate lenses
- Switch: On/Off rocker switch
- Weight: 10 lbs. (light head only)
- Height: 14" (light head)
- Diameter: 6" (light head)
- 120 W
- Lighting range: 50'
- Approvals: cETLus portable work light



LIND **E** EQUIPMENT

Model No.	Description	Price /Each
XE636	w/Magnet Mount	828.00
XE637	w/Clamp	809.00
XE638	w/Tripod	846.00

BEACON LED FLOODLIGHTS

- 40 W as bright as a 500 W quartz-halogen floodlight
- 30 W as bright as a 300 W quartz-halogen floodlight
- Low operating temperature, resulting in a safer working environment
- Low energy usage and no bulb replacement, resulting in large total cost of ownership savings
- High quality LEDs are rated for over 50 000 hours
- Durable aluminum housing and tempered glass lens
- IP65 environmental rating and starts instantly in cold weather
- 15' 18/3 SJOW cord
- Certified for sale in Canada by an accredited certification body



Model No.	Description	Lumens	Price /Each
FLOODLIGHTS			
XE855	40 W LED Floodlight Base Model	6000	349.00
XC942	40 W LED Floodlight with Floor Stand	6000	399.00
XC941	40 W LED Floodlight with Tripod	6000	409.00
XD044	40 W LED Dual Head Floodlight with Tripod	12 000	1059.00
XD045	40 W LED Floodlight with Magnet Mount	6000	409.00
XD046	40 W LED Floodlight with Clamp Mount	6000	419.00
RECHARGEABLE FLOODLIGHTS			
XE862	30 W LED Rechargeable Floodlight Base Model	3000	365.00
XE863	30 W LED Rechargeable Floodlight with Floor Stand	3000	395.00
XE864	30 W LED Rechargeable Floodlight with Tripod	3000	439.00
XE865	30 W LED Rechargeable Dual Head Floodlight with Tripod	6000	885.00
XE867	30 W LED Rechargeable Floodlight with Clamp Mount	3000	439.00

HAND-WIND ELECTRIC CABLE REELS

- Provides a portable power centre for tools and equipment
- Frame is made from heavy-duty steel tubing, and features a contoured comfort grip
- Side discs are rolled to provide increased rigidity and strength
- Powder painted for a long-lasting, tough finish
- Equipped with four 120 V 15/20 A T-slot receptacles and 120 V 15 A plug
- LED illuminates to indicate that the reel is connected to power
- Resettable circuit breaker protects against overloads
- Receptacles are recessed for protection against impact and inadvertent contact
- Enclosed terminals at the centre of the reel hub prevent users from contacting live connections
- Dimensions: 17 1/2" L x 11 1/2" W x 18" H
- Certified for sale in Canada by an accredited certification body



LIND EQUIPMENT

Model No.	Description	Price /Each
XC410	10" Pigtail, Ready for Winding Your Existing Extension Cord	589.00
XC411	Reel w/ 100' 12/3 500W Cord w/ Plug	905.00
XC412	Reel w/ 50' 12/3 500W Cord w/ Plug	755.00

LE9000 SERIES HEAVY-DUTY CORD REELS

- Durable all-steel weatherproof construction, NEMA4 weatherproof rating
- Adjustable cable guide arm (12 positions)
- Strong ratchet can be disengaged for constant tension
- Adjustable ball stop
- 6' feeder cord
- Standard SJOW or SOW cable
- Approvals: CSA, UL



LIND EQUIPMENT

Model No.	Cord Length'	Description	Rating	Price /Each
XC737	30	14/3 SJOW Single Outlet (5-15R)	15 A	1299.00
XC739	30	14/3 SJOW Quad-Box (5-15R)	15 A	1275.00
XC742	50	14/3 SJOW Single Outlet (5-15R)	15 A	1365.00
XC743	50	12/3 SJOW Single Outlet (5-20R)	20 A	1535.00
XC744	50	14/3 SJOW Quad-Box (5-15R)	15 A	1479.00
XC745	50	12/3 SJOW Quad-Box (5-20R)	20 A	1615.00

DATA CORD REELS

LE2300 SERIES RETRACTABLE DATA REELS

- Robust spring technology
- Compact and lightweight design
- Ideal in conference rooms or other areas where instant data connections are required without the mess of stray wires
- Certified for sale in Canada by an accredited certification body



LIND EQUIPMENT

Model No.	Cable Length'	Description	Price /Each
XD056	20	CAT6 Cable, Retractable Data Reel	405.00

HEAVY-DUTY LED WORK LIGHTS & CORD REELS

- Virtually indestructible with a polycarbonate lens and rubber handle
- 50000 hour LED technology means never having to change a bulb again
- XD047 has the same usable light output as a 13 W fluorescent work light
- XD047 also operates as a flashlight with a 1 W LED light on the end
- Standard with 25' of 18/2 SJTOW cord
- Also available on a 40' cord reel
- Certified for sale in Canada by an accredited certification body



LIND EQUIPMENT

Model No.	Description	Price /Each
XD047	8 W LED Work Light	305.00
XD049	40' Cord Reel w/8 W LED Work Light	549.00

CANADA'S LEADING MATERIAL HANDLING SUPPLIER



Positive latching mechanism allows the cord to be extended to any length required and automatically held in place. An adjustable ball stop provides easy height adjustment. Hardware included for either ceiling or wall mount.

INDUSTRIAL CORD REELS

- Provide secure wall or ceiling mounting
- A release tab on the mounting bracket quickly and easily converts the reel from stationary to portable use
- Large, comfortable carrying handle
- The non-metallic composite housing ensures a prolonged, corrosion-free service life
- Certified for sale in Canada by an accredited certification body
- Termination: Triple Outlet



DB978

Model No.	Cable Length'	Cable Type	Outlet Rating	Price /Each
DB978	40	12/3 SJTW	15 A, Breaker Protected	325.00
DB979	50	14/3 SJTW	13 A, Breaker Protected	325.00

EXTENSION REELS

- Triple outlet extension reel accommodates three tools
- Circuit breaker protects against power overloads, which can cause electrical fires
- Certified for sale in Canada by an accredited certification body



Model No.	Cable Length'	Description	Outlet Rating	Price /Each
XB281	30	14/3 SJT Cord	13 A	179.00

INDUSTRIAL 15 A CORD REELS

- Four 5-20R grounded outlets providing a full 15 A of power
- Power "ON" light indicator
- 20' of 12/3 SJTOW oil resistant and cold weather flexible cable
- Strong steel housing and epoxy finish enable the reel to be used in most industrial environments
- 15 A Circuit breaker protection against power overloads, which have the potential to cause electrical fires
- Hardware for ceiling or wall mounting included
- Certified for sale in Canada by an accredited certification body

Model No. XD052
Price /Each \$395.00



CORD REELS

Spring retractable cord reels are available in 3 styles. Standard female receptacle, LED and fluorescent lamp. Engineered for industrial use, these units are also compact, can be installed on walls, ceilings or under a tool bench.

Dimensions: 12 5/8" L x 9 3/8" W x 13 1/4" H.

All units feature 125 V SJTOW cord.

Certified for sale in Canada by an accredited certification body



XA172



TNB516



Model No.	Max. Amps	Cable Length'	Gauge	Wt. lbs.	Price /Each
LED					
TNB516	13	50	16/3	27	995.00
SINGLE OUTLET					
XA172	13	50	16/3	26	835.00

WIND-UP EXTENSION CORD

- 4 Grounded outlets
- Built-in resettable circuit breaker
- Length: 25'
- Gauge (AWG): 16/3 SJT
- Amperage: 10 A
- Wattage: 1250 W

Model No. XE671
Price/Each \$47.95



NO JOB TOO TOUGH!



PRODUITS D'ENTRETIEN - MAINTENANCE PRODUCTS

TECHNICAL INFORMATION

EXTENSION CORD RATING DESIGNATIONS

Indented on each Prime® cord is a letter designation that defines the type and approved use of the cord. You will see that each Prime® extension cord carries one of the following designations.

PRIME® OUTDOOR VINYL EXTENSION CORDS

SJTW (UL) Water Resistant or c(UL) SJTW FT2
STW (UL) Water Resistant or c(UL) STW FT2

PRIME® ALL-WEATHER TPE-RUBBER EXTENSION CORDS

SJEOW (UL) Water Resistant or c(UL) SJEOW FT2
SEOW (UL) Water Resistant or c(UL) SEOW FT2

PRIME® RUBBER EXTENSION CORDS

SJ (UL) Water Resistant or c(UL) SJ FT2
SJO (UL) Water Resistant or c(UL) SJO FT2
SJOW (UL) Water Resistant or c(UL) SJOW FT2
SJTOW (UL) Water Resistant or c(UL) SJTOW FT2
SO (UL) Water Resistant or c(UL) SO FT2
SOO (UL) Water Resistant or c(UL) SOO FT2
SOOW (UL) Water Resistant or c(UL) SOOW FT2
STOW (UL) Water Resistant or c(UL) STOW FT2

- S -** The "S" at the beginning of all designations states that the cord is a "Hard Service" flexible cord for general use.
- P -** Parallel construction, usually uninsulated and used in products such as household extension cords, air conditioner cords and low voltage landscape cable.
- J -** The "J" after the "S" defines the jacket of the cord as being the standard 300 V insulation type currently used on most extension cords. The absence of the "J" defines the cord jacket as an extra hard service 600 V insulation type defined by Prime® as our "Double Jacket" cord because the outer cord jacket is roughly twice the thickness of the "J" jacket that is normally used in outdoor extension cords.
- V -** Vacuum wire, softer and more flexible than standard "SJT", usually found on retractable cord reels and vacuum cleaner power supply and cords because it holds up to constant winding and unwinding but still maintains its shape.
- T or E -** This letter defines the material the insulation and jacket are made from. "T" defines the insulating material as PVC (vinyl) thermoplastic. The letter "E" defines the insulation and jacket material as TPE-thermoplastic elastomer rubber.
- O -** The letter "O" defines the cord as being "Oil Resistant". This was especially designed because most rubber type cords would break down and lose insulating performance when exposed to oil or grease.
- W -** This letter designates that the cord has been rated for outdoor use. As part of this rating, the different insulation and jacket compounds must meet the following use temperature ranges. UL sets a use temperature range of the "T" PVC vinyl material at -31°F to +140°F (-35°C to +60°C). Prime® has formulated the PVC vinyl compound in our products to exceed this nominal range by approximately 5°F. UL sets a use temperature range of the "E" TPE-rubber material at -58°F to +221°F (-50°C to +105°C). Prime® has also exceeded this range by approximately 12°F.
- (UL) -** This defines the cord as being "Underwriters Laboratories" listed. UL allows the use of the logo in parenthesis rather than a complete circle on round product, like a cord.
- Water Resistant -** Most of Prime®'s outdoor cords are now made with water resistant material. Standard vinyl and TPE-rubber cords have a tendency to absorb water if left lying in a puddle on the job site. When water comes in contact with the copper wire, it starts to corrode. If the water remains in the cord, it could build up until a shock path is created. When water gets in a cord, its life is shortened.
- CSA -** Defines the product as meeting "Canadian Standards Association" requirements. The CSA logo is usually not abbreviated.
- C(UL) & C CSA US -** Since the NAFTA agreement with Canada, UL and the Canadian Standards Association, CSA, have worked together to allow CSA to list products for the USA and for UL to list products for use in Canada. The c(UL) designation says the product was tested and certified by UL to Canadian Standards and the c CSA us mark signifies that CSA tested the product and certifies it to the UL Standards.
- FT2 -** This letter group defines the product as being flame retardant. If a standard vinyl or TPE-rubber cord catches on fire, the flame can quickly burn the entire length of the cord. The Prime® jacket insulation material will prevent the spread of combustion along the cord. The cord will extinguish the flame within 30 seconds of the heat source being removed.
- CL2 -** Or "Class 2" is a UL rating for wire that can be used for in-wall construction. Usually applies to communication cable or speaker wire.
- SRDT -** Is heavy-duty wire made specifically for use with higher amperage equipment such as ranges, dryers and mobile home power hook-up cords. Not very flexible.
- HPN -** Is high-heat parallel neoprene wire made specifically for use with clothes irons, portable heaters and other such applications where high temperatures of the appliance could affect the power cord's performance.



Cord Gauge vs Amperage

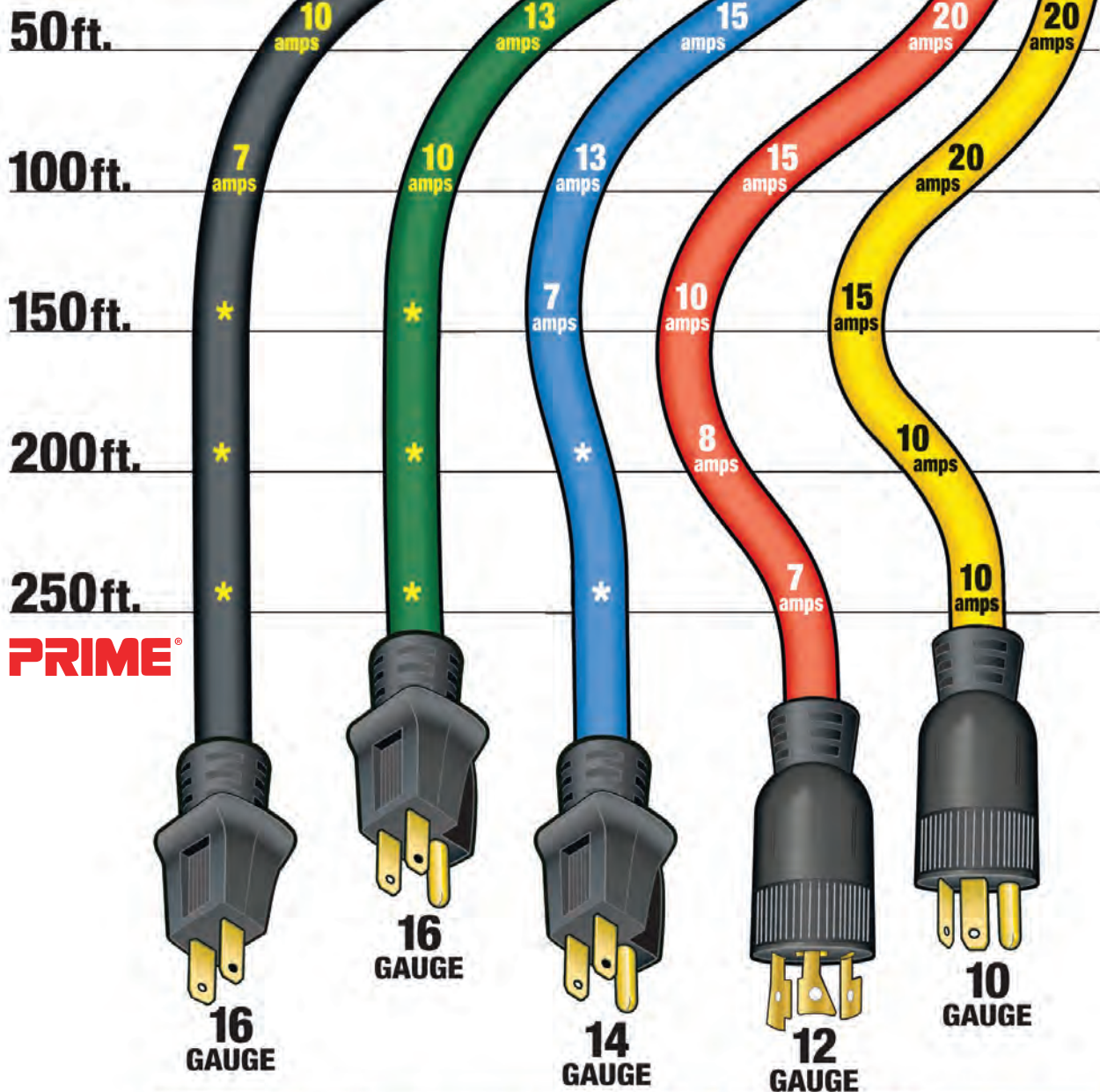

PRIME

TYPICAL USAGE GUIDE	MEDIUM DUTY		HEAVY DUTY	EXTRA HEAVY DUTY	ULTRA HEAVY DUTY
	Fans	Lawnmowers	Drills	Circular Saws	Generators
	Small Appliances	Hedge Trimmers	Belt Sanders	Chain Saws	Recipro Saws
	Stereos	Space Heaters	Routers	Worm Drives	Rotary Hammers
	Household Tools	Jig Saws	Table Saws	Grinders	Compressors

*Not recommended for use at this length

OUTDOOR VINYL EXTENSION CORDS

- Designed for industrial and contractor use
- Vinyl jacket protects against rough use, chemicals, and moisture and provides added flexibility
- Molded-on and bonded plugs and connectors resist breaking



AURORA
TOOLS

3-CONDUCTOR SJTW, 300 V GROUNDING

Model No.	Length'	AWG	Amps	Watts	Colour	Price /Each
HEAVY-DUTY						
XC482	25	14/3	15	1875	Orange	26.65
XC483	50	14/3	15	1875	Orange	50.40
XC484	100	14/3	13	1625	Orange	96.95
EXTRA HEAVY-DUTY						
XC485	25	12/3	15	1875	Yellow	42.55
XC486	50	12/3	15	1875	Yellow	76.10
XC487	100	12/3	15	1875	Yellow	149.00

XC485



NEMA 5-15P



NEMA 5-15R

OUTDOOR VINYL TRIPLE TAP EXTENSION CORDS

- Designed for industrial and contractor use
- Vinyl jacket protects against rough use, chemicals, and moisture
- Vinyl jacket provides added flexibility
- Molded-on and bonded plugs and connectors resist breaking



AURORA
TOOLS

3-CONDUCTOR SJTW, 300 V GROUNDING

Model No.	Length'	AWG	Amps	Watts	Colour	Price /Each
HEAVY-DUTY						
XC488	25	14/3	15	1875	Red	39.95
XC489	50	14/3	15	1875	Red	66.45
XC490	100	14/3	13	1625	Red	112.00
EXTRA HEAVY-DUTY						
XC491	25	12/3	15	1875	Red	52.45
XC492	50	12/3	15	1875	Red	93.95
XC493	100	12/3	15	1875	Red	162.00

XC491



NEMA 5-15P



NEMA 5-15R

OUTDOOR VINYL TRIPLE TAP EXTENSION CORDS

- Designed for use by contractors and industrial personnel
- Jacket protects against rough use, chemicals, moisture, ozone and gives added flexibility at below freezing temperatures
- Molded-on and bonded vinyl plugs and connectors resist breaking or pulling off cord
- Nickel-coated brass blades resist corrosion
- XA719, XA720, XA721 are No Overload® circuit breaker extension cords



PRIME

3-CONDUCTOR SJTW, 300 V GROUNDING

Model No.	Length'	AWG	Amps	Watts	Colour	Price /Each
HEAVY-DUTY						
XA719	25	14/3	15	1875	Red	53.60
XA720	50	14/3	15	1875	Red	99.90
XA721	100	14/3	13	1625	Red	173.00
EXTRA HEAVY-DUTY						
XA722	25	12/3	15	1875	Yellow	66.20
XA723	50	12/3	15	1875	Yellow	121.00
XA724	100	12/3	15	1875	Yellow	193.00

XA719



NEMA 5-15P



NEMA 5-15R

GLACIER FLEX™ 3-OUTLET ENGINE BLOCK HEATER CORDS

- 3 conductors, SJTW -50°C, 300 V grounding
- Water-resistant
- Flame retardant
- Ultra flexible
- Nickel-coated brass blades resist corrosion
- Temperature range from -50°F to +140°F (-50°C up to +60°C)
- Primelight® indicator light flashes blue and red when power is on



PRIME

Model No.	Length'	AWG	Amps	Watts	Price /Each
XC730	15	16/3	13	1625	26.60

XC730



EXTENSION CORDS

ALL WEATHER TPE-RUBBER EXTENSION CORDS WITH LIGHT INDICATOR

- Designed for industrial and contractor use
- All-weather jacket provides ultra flexibility and superior performance in extreme climate conditions at temperatures from -50°C to 105°C
- Provides outstanding resistance against rough use, sunlight, chemicals and moisture
- Water-resistant and flame retardant
- Lighted connectors allow you to see when the power is in use
- Molded-on and bonded plugs and connectors resist breaking

3-CONDUCTOR SJEOW, 300 V GROUNDING

Model No.	Length'	AWG	Amps	Watts	Colour	Price /Each
HEAVY-DUTY						
XC500	25	14/3	15	1875	Blue/Orange	37.25
XC501	50	14/3	15	1875	Blue/Orange	60.45
XC502	100	14/3	13	1625	Blue/Orange	131.00
EXTRA HEAVY-DUTY						
XC503	25	12/3	15	1875	Blue/Orange	47.45
XC504	50	12/3	15	1875	Blue/Orange	93.25
XC505	100	12/3	15	1875	Blue/Orange	177.00



XC500



TRIPLE TAP ALL-WEATHER TPE-RUBBER EXTENSION CORDS WITH LIGHT INDICATOR

- Designed for industrial and contractor use
- All-weather jacket provides ultra flexibility and superior performance in extreme climate conditions at temperatures from -50°C to 105°C
- Provides outstanding resistance against rough use, sunlight, chemicals and moisture
- Water-resistant and flame retardant
- Lighted connectors allow you to see when the power is in use
- Molded-on and bonded plugs and connectors resist breaking

3-CONDUCTOR SJEOW, 300 V GROUNDING

Model No.	Length'	AWG	Amps	Watts	Colour	Price /Each
HEAVY-DUTY						
XH235	25	14/3	15	1875	Blue/Orange	43.95
XH236	50	14/3	15	1875	Blue/Orange	77.95
XH237	100	14/3	13	1625	Blue/Orange	152.00
EXTRA HEAVY-DUTY						
XH238	25	12/3	15	1875	Blue/Orange	55.40
XH239	50	12/3	15	1875	Blue/Orange	106.00
XH240	100	12/3	15	1875	Blue/Orange	197.00



XH237

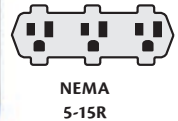

ARCTIC BLUE™ ALL-WEATHER TPE-RUBBER LIGHTED END EXTENSION CORDS W/PRIMELOK® & PRIMELIGHT®

- Arctic Blue™ cords are designed for use by contractors and industrial personnel, providing an all weather cordset made for outstanding performance in extreme climate conditions at temperatures from -58°F to 221°F (-50°C to 105°C)
- One-third lighter than standard rubber cords
- Provides superior resistance to sunlight, ozone, cracking, oils and chemicals and are outstanding in resistance to abuse, rough handling and wear
- Flame retardant and water resistant
- Distinctive orange stripe extruded into the cord
- Primelok® keeps power tool connections from coming loose
- Primelight® indicator light allows you to see there is power to the cord

3-CONDUCTOR SJEOW, 300 V GROUNDING

Model No.	Length'	AWG	Amps	Watts	Colour	Price /Each
HEAVY-DUTY						
XB894	25	14/3	15	1875	Blue/Orange	46.50
XB895	50	14/3	15	1875	Blue/Orange	67.10
XB896	100	14/3	13	1625	Blue/Orange	137.00
EXTRA HEAVY-DUTY						
XB897	25	12/3	15	1875	Blue/Orange	50.80
XB898	50	12/3	15	1875	Blue/Orange	110.80
XB899	100	12/3	15	1875	Blue/Orange	223.00



XB895



OUTDOOR VINYL EXTENSION CORDS WITH LIGHT INDICATOR

- Designed for industrial and contractor use
- Vinyl jacket protects against rough use, chemicals, and moisture
- Ultra flexible cord
- Lighted connectors allow you to see when the power is in use
- Molded-on and bonded plugs and connectors resist breaking
- Water-resistant and flame retardant

3-CONDUCTOR SJTOW, 300 V GROUNDING, OIL RESISTANT

Model No.	Length'	AWG	Amps	Watts	Colour	Price /Each
EXTRA HEAVY-DUTY						
XC494	25	12/3	15	1875	Yellow	48.50
XC495	50	12/3	15	1875	Yellow	83.25
XC496	100	12/3	15	1875	Yellow	159.00



NEMA 5-15P



NEMA 5-15R

XC494

OUTDOOR TRIPLE TAP VINYL EXTENSION CORDS WITH LIGHT INDICATOR

- Same great features as outdoor single tap vinyl extension cords but with a lighted triple tap connector

3-CONDUCTOR SJTOW, 300 V GROUNDING, OIL RESISTANT

Model No.	Length'	AWG	Amps	Watts	Colour	Price /Each
EXTRA HEAVY-DUTY						
XC497	25	12/3	15	1875	Yellow	51.95
XC498	50	12/3	15	1875	Yellow	99.85
XC499	100	12/3	15	1875	Yellow	164.00



NEMA 5-15P



NEMA 5-15R

XC497

INDOOR/OUTDOOR STANDARD-DUTY EXTENSION CORDS

- Designed for light industrial, contractor, and home use
- Durable SJTW jacket protects against ultraviolet rays, chemicals and moisture
- Extremely flexible jacket
- Molded-on and bonded plugs and connectors resist breaking

3-CONDUCTOR SJTW, 125 V GROUNDING

Model No.	Length'	AWG	Amps	Watts	Colour	Price /Each
XC630	10	16/3	13	1625	Orange	11.70
XC631	15	16/3	13	1625	Orange	16.25
XC632	25	16/3	13	1625	Orange	24.60
XC633	50	16/3	13	1625	Orange	43.85



NEMA 5-15P



NEMA 5-15R

XC630

EXTENSION CORDS

FLEXZILLA® PRO INDUSTRIAL EXTENSION CORD

- Extreme all-weather flexibility in temperatures ranging from -58°F (-50°C) to 167°F (75°C)
- Resists kinks & coils easily
- Lighted plug and glow-in-the-dark strip for easy visibility
- For use indoors and outdoors
- Features a grounded plug
- Water resistant and flame retardant
- UL listed
- Meets applicable OSHA Design Standards

PRIME®

3-CONDUCTOR SJTW

Model No.	Length'	AWG	Amps	Watts	Colour	Price /Each
XI521	25	14/3	15	1875	Neon Green	58.00
XI522	50	14/3	15	1875	Neon Green	107.00
XI523	100	14/3	15	1875	Neon Green	219.00
XI518	25	12/3	15	1875	Neon Green	82.10
XI519	50	12/3	15	1875	Neon Green	158.00
XI520	100	12/3	15	1875	Neon Green	314.00
XI516	50	10/3	15	1875	Neon Green	272.00
XI517	100	10/3	15	1875	Neon Green	509.00



XI521

NEON FLEX® HIGH VISIBILITY NEON COLOUR OUTDOOR EXTENSION CORDS W/PRIMELIGHT®

- Combine all the features of a standard vinyl outdoor extension cord with ultra-high-visibility neon colours
- Brighter than other coloured cords and also extremely shiny
- Flame retardant and water-resistant
- Nickel coated brass blades resist corrosion
- Primelight® connector allows you to see when the power is on
- Ultra flexible, contractor tough
- Provides same performance in extreme climate conditions at temperature from -58°F to 140°F (-50°C to 60°C)



3-CONDUCTOR SJTW, 300 V GROUNDING

Model No.	Length'	AWG	Amps	Watts	Colour	Price /Each
EXTRA HEAVY-DUTY						
XB890	50	12/3	15	1875	Neon Green	107.00
XB891	100	12/3	15	1875	Neon Green	189.00
XB892	50	12/3	15	1875	Neon Pink	110.00
XB893	100	12/3	15	1875	Neon Pink	188.00



XB891



NEMA 5-15P



NEMA 5-15R

ALL-RUBBER™ OUTDOOR EXTENSION CORD

- Oil-resistant, all-rubber jacket and industrial-grade conductors
- Primelight® power indicator lights shows when the power is on
- Oversized plugs & strain reliefs prevent wire from separating from the plugs
- Nickel-coated brass blades resist corrosion and arcing
- Ultra-flexible in temperatures ranging from -40°F (-40°C) to 221°F (105°C)

PRIME®

3-CONDUCTOR SJOOW

Model No.	Length'	AWG	Amps	Watts	Colour	Price /Each
XI524	25	14/3	15	1875	Black	54.60
XI525	50	14/3	15	1875	Black	102.00
XI526	100	14/3	15	1875	Black	209.00
XI527	25	12/3	15	1875	Black	80.30
XI528	50	12/3	15	1875	Black	156.00
XI529	100	12/3	15	1875	Black	310.00



XI529

ARCTIC BLUE™ ALL-WEATHER TRIPLE TAP TPE-RUBBER LIGHTED END EXTENSION CORDS W/PRIMELIGHT®

- Arctic Blue™ cords are designed for use by contractors and industrial personnel
- All weather cordset made for outstanding performance in extreme climate conditions at temperatures from -58°F to 221°F (-50°C to 105°C)
- Superior resistance to ozone, oils, chemicals and rough handling
- Flame retardant and water resistant
- Primelight® indicator light allows you to see there is power to the cord



NEMA 5-15R



NEMA 5-15P

3-CONDUCTOR SJEOW, 300 V GROUNDING

Model No.	Length'	AWG	Amps	Watts	Colour	Price /Each
EXTRA HEAVY-DUTY						
XB902	25	12/3	15	1875	Blue/Orange	69.40
XB903	50	12/3	15	1875	Blue/Orange	162.90
XB904	100	12/3	15	1875	Blue/Orange	283.00

XB904

HEAVY-DUTY NEOPRENE EXTENSION CORDS

- Designed to provide longer life in the most demanding environments, such as industrial, mining, and construction sites
- Made of heavy-duty rubber suitable for indoor and outdoor applications requiring flexibility and mechanical toughness
- Exceptional resistance to oil, moisture, ozone, sunlight, chemicals, cuts, cracking, and abrasions
- Stays flexible, even at -40°F (-40°C) and resists heated objects and oils up to 194°F (90°C)
- 600 V SOOW cable has oil-resistant double-thick outer jacket and oil-resistant inner insulation
- Includes rugged nylon plug and connector rated for 125 V 15 A (NEMA 5-15)
- Certified for sale in Canada by an accredited certification body



XA254

Model No.	Length'	Gauge	Cord Rating	Price /Each
XA071	25	16/3	13 A	135.00
XA260	50	16/3	13 A	255.00
XA255	100	16/3	10 A	359.00
XA253	25	14/3	15 A	179.00
XA254	50	14/3	15 A	279.00
XA252	100	14/3	15 A	405.00
XC996	25	12/3	15 A	209.00
XC997	50	12/3	15 A	299.00
XC998	100	12/3	15 A	439.00

WIND-UP EXTENSION CORD

- 4 Grounded outlets
- Built-in resettable circuit breaker
- Length: 25'
- Gauge (AWG): 16/3 SJT
- Amperage: 10 A
- Wattage: 1250 W

Model No. XE671
Price/Each \$47.95



AURORA
TOOLS

EXTENSION REELS

- Triple outlet extension reel accommodates three tools
- Circuit breaker protects against power overloads, which can cause electrical fires
- Certified for sale in Canada by an accredited certification body



Model No.	Cable Length'	Description	Outlet Rating	Price /Each
XB281	30	14/3 SJT Cord	13 A	179.00

EXTENSION CORDS

IN-LINE GFCI CORD SETS

- Excellent for use with high pressure washers, power drain snakes, submersible pumps and any equipment used in or around wet areas
- Rainproof rated with booted test and reset buttons
- Standard 14' length (other lengths available upon request)
- Certified for sale in Canada by an accredited certification body

NOTE: XA466 includes 120 V/20 A straight blade ends



LIND **E** EQUIPMENT

Model No.	Cord Type	NEMA P & R	Volts /Amps	Price /Each
XE722	12/3 SJTW	5-15	120 V/15 A	119.00
XA466	12/3 SJTW	5-20	120 V/20 A	199.00

SHOCKSAFE® INLINE GFCI TRIPLE-TAP ADAPTER

- Triple lighted tap
- 3' 12/3 SJTW cord
- 125 V/15A

Model No. XC614
Price/Each \$67.80



PRIME® 

PLUG & CORD SETS

- Ideal for use with any equipment used in or around wet areas
- Rainproof rated with booted test and reset buttons
- 9" 14/3 SJTW cord
- NEMA 5-15 P & R, 120 V/15 A
- Certified for sale in Canada by an accredited certification body

Model No. XA463
Price/Each \$57.90



LIND **E** EQUIPMENT

GFCI QUAD OUTLET BOXES

- Four GFCI protected NEMA 5-15R outlets enclosed in an impact resistant polymer case with spring-loaded covers
- 15 A "fast breaker" is built into the box for convenient reset should an overload condition occur
- 6' 12/3 SJTW cord
- 120 V/15 A
- Certified for sale in Canada by an accredited certification body

Model No. XA467
Price/Each \$245.00

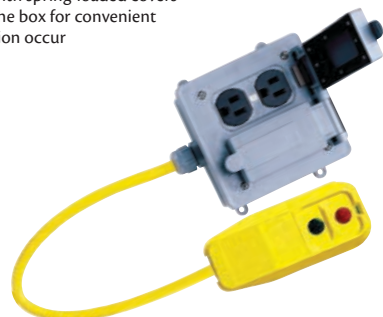

LIND **E** EQUIPMENT

GFCI PROTECTED TRI-CORDS

- Features three NEMA 5-15R receptacles at the end of a heavy-duty molded T-head
- Perfect for outdoor, rugged, construction type environments
- 2' 12/3 SJTW cord
- 120 V/15 A
- Available with right angle plug (XA468) or with in-line plug (XC519)
- Certified for sale in Canada by an accredited certification body

Model No. XA468
Price/Each \$70.90

Model No. XC519
Price/Each \$94.50



LIND **E** EQUIPMENT

GFCI OUTLET ADAPTORS W/SURGE PROTECTION

- Small size (less than 2" W x 3" H) makes them ideal for the toolbox
- XB069 includes booted test and reset buttons
- NEMA 5-15 P & R, 120 V/15 A
- Certified for sale in Canada by an accredited certification body

Model No. XB069 Yellow
Price/Each \$49.50



LIND **E** EQUIPMENT

USER ATTACHABLE GFCI PLUGS

- Replaces any standard NEMA 5-15 P plug on cords between 12-18 AWG (SJT)
- For use where the GFCI is needed as a permanent part of the tool or appliance
- Rainproof rated with booted test and reset buttons
- NEMA 5-15 P, 120 V/15 A
- Certified for sale in Canada by an accredited certification body

Model No. XA462
Price/Each \$82.50



LIND **E** EQUIPMENT

USER ATTACHABLE INLINE GFCI

- Easily wires onto cord between 12-18 AWG (SJT)
- Can be placed at any location on the cord set
- Rated for up to 20 amps to allow for use on equipment that operates on either a 15 A or 20 A circuit
- For use where the GFCI is needed as a permanent part of the tool or appliance
- Rainproof rated with booted test and reset buttons
- 120 V/20 A
- Certified for sale in Canada by an accredited certification body

Model No. XB070
Price/Each \$115.00



LIND **E** EQUIPMENT

SURGE SUPPRESSOR

- Ideal for multiple electronic devices
- Lighted on/off switch with built-in circuit breaker
- Protects against damage caused by power spikes
- No. of Outlets: 6
- Cord Length: 3'
- Rated Joules: 200
- Max. Amps: 15 A
- Wattage: 1875 W

Model No. XE670
Price/Each \$10.95



AURORA
TOOLS

USB CHARGING SURGE PROTECTOR

- Protects devices from power surges and spikes
- Protected mode indicator light
- Lighted ON/OFF switch
- No. of Outlets: 6
- Cord Length: 6'
- Rated Joules: 1200 J
- Amps: 15 Amps
- Wattage: 1875 W
- Voltage: 125 V
- No. of USB Ports: 2
- USB Charging Ports: 2.1 Amp
- Housing Material: ABS Plastic
- Colour: White

Model No. XH064
Price/Each \$23.65



AURORA
TOOLS



400 JOULES 6-OUTLET SURGE PROTECTOR

- 125 V / 15 A, 1875 W
- Clear Power® auto shut-off safeguard shuts power off after a major spike
- \$100 000 connected equipment warranty

Model No. XC616
Price/Each \$13.00



PRIME



1000 JOULES SURGE PROTECTOR

- Provides extra power for home electronics
- Clear Power® auto shut-off safeguard
- \$100,000 connected equipment warranty
- No. of Outlets: 6
- Cord Length: 4'
- Voltage: 125 V

Model No. XC300
Mfg.No PB802225
Price/Each \$17.60



PRIME



750 JOULES 6-OUTLET SURGE PROTECTORS

- Provides extra power for home electronics
- Features high energy joule rating
- Clear Power® auto shut-off safeguard shuts power off after absorbing a major spike
- \$100 000 connected equipment warranty

Model No. XC299
Price/Each \$16.60



PRIME



1150 JOULES SURGE PROTECTORS

- Provide extra power outlets for home electronics in the workshop, the kitchen, or the office
- Features high energy absorbing joule ratings and EMI/RFI filters
- Clear Power® auto shutoff safety device shuts power off after absorbing a major spike
- Lighted On/Off circuit breaker switch
- 6 outlet black metal housing prevents damage to the casing
- 14/3 SJT snug plug low profile power cord
- 15 A, 1875 W
- \$200 000 connected equipment warranty
- Length: 15'

Model No. XC042
Mfg.No PB802135
Price/Each \$47.70



PRIME



EXTENSION CORDS

4', 12-OUTLET POWER BARS

- Provides extra power for home electronics
- 6', 14/3 extension cord
- Lighted on/off circuit breaker
- Mounting hardware included
- 5-year warranty

Model No. XC291
Price/Each \$50.10



WORKSHOP SURGE PROTECTOR POWER STRIP

- Features cord wrap and surge protector to protect your devices from an overload
- Lighted on/off switch
- Keyhole slots on the back of the unit allow the model to be mounted under a desk, on walls or other locations
- Indoor use only
- No. of Outlets: 8
- Cord Length: 6'
- Rated Joules: 1350 J
- Amps: 15 Amps
- Wattage: 1875 W
- Voltage: 125 V
- Housing Material: Metal
- Colour: Black/Yellow

Model No. XH162
Price/Each \$27.75



GENERATOR "Y" CORDS

- 20 A T-blade plug to 20 A T-slot connectors
- Enables user to draw full 20 A load (5 more amps than a standard U-Ground connector)
- 25' 12/3 STOW wire
- 20 A / 125 V / 2500 W
- Primelight™ power indicator light indicates when power is ON
- Double-jacketed, super abrasion resistant
- Oil and water resistant
- Flame retardant
- Ultra-flexible in extreme temperatures from -58°F up to +221°F (-50°C up to +105°C)
- For use with virtually all generators
- Used for lighting, small air conditioners, air compressors, water pumps, power tools and equipment with 1 HP rating

Model No. XD001
Price/Each \$156.00



AIR CONDITIONER & MAJOR APPLIANCES EXTENSION CORDS

- Molded-on bonded vinyl plugs and connectors will not break off or pull
- Cord resists cracking and breaking
- 3-conductor SPT-3
- 15 A, 1875 W
- 14/3 SPT cable



Model No.	Length'	Price /Each
XC156	3	7.53
XC157	6	10.10



NON-CONTACT AC VOLTAGE DETECTOR WITH FLASHLIGHT

- Provides the ability to detect the presence of AC voltage from a safe distance
- Features two voltage ranges allowing it to detect both high (90 to 1000 V) and low (24 to 1000 V) AC voltage wiring
- Suitable for receptacles or against insulated wire
- Double insulated housing for increased safety
- Audible (buzzer) and visual (LED) indicators
- Built-in flashlight
- Pocket clip
- Auto shut off
- Includes: (1) Non-contact AC voltage detector, (2) AAA batteries
- Alert Type: Light & Sound
- Overvoltage Category: CAT. IV 1000V
- Certification(s): CE, ETL

Model No. IC766
Mfg. No. R5110
Price/Each \$25.00



RECEPTACLE TESTER WITH GFCI

- Tests whether the outlet is properly wired
- Can perform the entire array of tests by simply plugging the device into the outlet
- Easy to read light pattern chart
- Detects most common 3-wire receptacle issues
- LED indicators identify 5 wiring faults
- GFCI trip test
- Voltage: 110 - 125V AC
- Frequency Range: 50 - 60Hz
- Maximum Current: 15 A



Model No.	Mfg. No.	Description	Price /Each
IC455	R5210	Receptacle Tester with GFCI	15.00



USB CHARGERS

- Includes LED charging light
- Space-saving design



Model No.	Mfg. No.	No. of USB Charging Ports	No. of Outlets	Joule Rating	Price /Each
XG785	PBUSB340	2 (3.4A)	0	-	35.60
XG784	PBUSB241S	1 (2.4A)	1	150	19.80
XG780	PBUSB242	2 (2.4A)	2	-	19.40
XG783	PBUSB342S	2 (3.4A)	2	450	28.20
XG782	PBUSB343S	2 (2.1A)	3	950	24.00
XG781	PBUSB346S	2 (2.1A)	6	1200	35.20

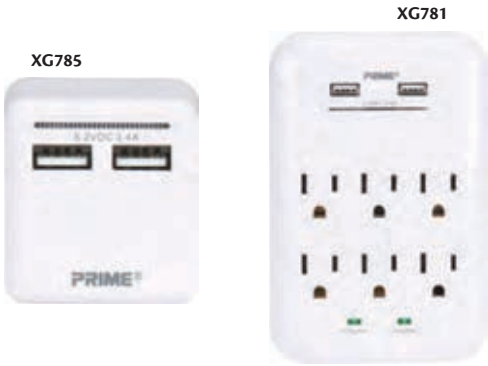

USB CHARGING SURGE PROTECTORS

- Housing Material: ABS Plastic
- Plug Type: Right Angle
- 2.1 Amp USB charging ports
- Protected and grounded indicator lights
- Lighted ON/OFF switch
- Amps: 15 Amps
- Wattage: 1875 W
- Voltage: 125 V



XG813



XG811



XG809



Model No.	Total No. of Outlets	Cord Length'	Rated Joules	No. of USB Ports	Colour	Transformer Outlet	Price /Each
XG809	4	4	1200	2	White	1 Convenient Transformer-Spaced Outlet	39.30
XG811	6	4	1800	2	White	1 Convenient Transformer-Spaced Outlet	50.90
XG810	8	6	2400	2	White	3 Convenient Transformer-Spaced Outlet	39.70
XG812	8	6	3600	2	Black	3 Convenient Transformer-Spaced Outlet	46.80
XG813	12	6	4200	2	Black	6 Convenient Transformer-Spaced Outlet	65.20

Maintain the ideal temperature in your workplace

MATRIX
INDUSTRIAL PRODUCTS

GENERATORS

1800-W GAS GENERATOR

- Powerful 3 HP, 4 stroke air cooled OHV engine
- Low oil shut-off with indicator light protects the engine
- Easy start recoil starter
- AC and DC circuit breakers for safe operation
- Comes with DC cables and spark plug socket
- CSA and EPA approved
- Fuel Tank Capacity: 7 L
- Weight: 56 lbs.
- Overall Height: 15-1/4"
- Overall Width: 18-1/2"
- Overall Depth: 14"
- Surge Power: 1800 W
- Rated Power: 1400 W
- Voltage Output: 120 V
- Run Time: 9 Hours
- Oil Capacity: 0.5 L

Model No.	Mfg. No.	Price /Each
XI539	KCG-1501GX	537.00



5100-W GAS GENERATOR WITH WHEEL KIT

- Powerful 8 HP, 4 stroke air cooled OHV engine
- AVR system and electronic ignition
- Easy start recoil starter
- AC double throw circuit breaker and resets for safe operation
- Includes: (2) 8" wheels, (1) Pivot handle, (1) Spark plug socket
- Noise level: 75 dB
- Voltage Output: 120 V, 240 V
- Fuel Tank Capacity: 15 L
- Weight: 107 lbs.
- Overall Height: 22"
- Overall Width: 25-1/2"
- Overall Depth: 22-1/2"
- Surge Power: 5100 W
- Rated Power: 4000 W
- Voltage Output: 120 V, 240 V
- Fuel: Unleaded Gasoline
- Oil Capacity: 0.6 L
- Run time: 7 - 8 hrs.
- Noise level: 75 dB

Model No.	Mfg. No.	Price /Each
XI497	KCG-5100G	598.00



6500-W ELECTRIC START GAS GENERATOR WITH WHEEL KIT

- Powerful 10 HP, 4 stroke air cooled OHV engine
- AVR system and electronic ignition
- Low oil shut-off with indicator light protects the engine
- Keyed electric start and easy start recoil starter
- AC double throw circuit breaker and resets for safe operation
- Neutral bonded to frame
- Features two duplex outlets (120V) and one twist lock outlet (120V & 240V)
- CSA and EPA approved
- Includes: 8" Wheels, Pivot handle, 12 V Battery, Spark plug socket
- Fuel Tank Capacity: 20 L
- Weight: 135 lbs.
- Overall Height: 21"
- Overall Width: 24-1/4"
- Overall Depth: 24-1/2"
- Surge Power: 6500 W
- Rated Power: 5000 W
- Voltage Output: 120 V, 240 V
- Run Time: 7-8 Hours
- Oil Capacity: 0.7 L

Model No.	Mfg. No.	Price /Each
XI537	KCG-6502GE	889.00



10 000-W GAS GENERATOR WITH ELECTRIC START

- Powerful 15 HP, 4 stroke air cooled OHV engine
- AVR system and electronic ignition
- Low oil shut-off with indicator light protects the engine
- Two duplex outlets: 120V/20 Amp. AC
- Two twist lock outlets: 120V/30 Amp. and 120V/240V/30 Amp. AC
- Keyed electric start and easy start recoil starter
- AC double throw circuit breaker and resets for safe operation
- Wheel kit includes 10" wheels and pivot handles
- Neutral bonded to frame
- CSA and EPA approved
- Comes with 12V battery and spark plug socket
- Fuel Tank Capacity: 25 L
- Surge Power: 10000 W
- Rated Power: 7500 W
- Voltage Output: 120 V, 240 V

Model No.	Mfg. No.	Price /Each
XI762	KCG-10001GE	1303.00



12 000-W ELECTRIC START GAS GENERATOR WITH WHEEL KIT

- AVR system and electronic ignition
- Low oil shut-off with indicator light protects the engine
- Keyed electric start and easy start recoil starter
- AC double throw circuit breaker and resets for safe operation
- Features an ammeter/voltmeter and frequency/time digital meter
- Neutral bonded to frame
- Features two 120V/20 Amp duplex outlets, one 120 V/30 Amp twist lock outlet, and one 120V/240V/50 Amp outlet
- Includes: 10" Wheels, Pivot handle,
- 12V Battery, Spark plug socket
- Fuel Tank Capacity: 31 L
- Weight: 250 lbs.
- Overall Height: 26-1/2"
- Overall Width: 36-3/4"
- Overall Depth: 27-1/4"
- Surge Power: 12000 W
- Rated Power: 9000 W
- Voltage Output: 120 V, 240 V
- Run Time: 6 Hours
- Oil Capacity: 1.1 L

Model No.	Mfg. No.	Price /Each
XI538	KCG-12000GE	1502.00



15 000-W V-TWIN GASOLINE GENERATOR

- Provides dependable power for home, recreation, job sites and emergencies
- Powerful 20 HP, V-Twin, horizontal shaft, 4-stroke, air-cooled, OHV engine
- AVR system and electronic ignition
- AC double-throw circuit breaker and resets
- Wheel kit includes 12" wheels and pivot handles
- Neutral bonded to frame
- CSA and EPA approved
- Comes with 12V battery, spark plug socket and funnel
- Fuel Tank Capacity: 40 L
- Weight: 389 lbs
- Overall Height: 38-3/8"
- Overall Width: 32"
- Overall Depth: 34"
- Surge Power: 15000 W
- Rated Power: 12500 W
- Voltage Output: 120 V, 240 V
- Outlet: 120V/240V/50 Amp. AC

Model No.	Mfg. No.	Price /Each
XH198	KCG-15000GE	3372.00



GENERATORS

5100-W GAS/PROPANE GENERATOR WITH ELECTRIC START

- Features a powerful 8 HP, 4-stroke air cooled OHV engine
- This generator can run on gasoline or propane giving you the flexibility to choose
- Equipped with an AVR system and electronic ignition
- Low oil shut-off with indicator light protects the engine
- Keyed electric start and easy start recoil starter
- AC double throw circuit breaker and resets for safe operation
- Neutral bonded to frame
- Fuel Tank Capacity: 15 L
- Weight: 118 lbs.
- Overall Height: 22"
- Overall Width: 22-1/2"
- Overall Depth: 25-1/2"
- Surge Power: 5100 W
- Running Wattage: 4000 W (Gasoline)/3600 W (Propane)
- Engine (OHV): 8 HP
- No Load Speed: 3750 RPM
- Displacement: 224 CC
- Oil Capacity: 0.6 L
- Run Time: 7-8 hrs.
- Noise Level: 75 dB(A)
- Certifications: CSA & EPA Approved
- Includes: (2) 8" Wheels, (1) Pivot Handle, (1) Propane Tank Connection Cable, (1) 12V Battery, (1) Spark Plug Socket, (1) Gasoline/Propane Generator



Model No.	Mfg. No.	Price /Each
UAV629	KCG-5101GE-DF	813.00

2000-W GAS DIGITAL INVERTER GENERATORS

- Sine wave digital inverter generator provides stable current to power voltage-sensitive electronics
- Powerful 4.5 HP, 4 stroke air cooled OHV engine
- Designed for quiet operation suitable for home use, camping and boating
- Economical mode switch adjusts the engine speed based on connected load, for improved fuel consumption
- Low oil shut-off, overload and power indicator lights
- AC circuit breaker and reset for safe operation
- Easy start manual recoil starter
- CSA and EPA approved
- Comes with DC cables, spark plug socket, oil fill container, screwdriver and oil drain pipe
- AC Output (Max): 2000 W
- AC Output (Rated): 1600 W
- Amperage: 16.7 A
- DC Output: 12 V/ 8.3 A
- Fuel Tank Capacity: 5.4 L
- Run Time: 5-6 hrs.
- Weight: 58 lbs.



Model No.	Mfg. No.	Price /Each
XC979	KCG-2000I	889.00

4500-W GAS INVERTER GENERATOR

- Sine wave digital inverter generator provides stable current to power voltage-sensitive electronics
- Features a powerful 8 HP, 4-stroke air cooled OHV engine, DC USB port, and DC cigarette lighter socket
- Remote start, single-push button electric start or recoil start
- Parallel connectivity between two inverter generators for combined output power
- Fuel Tank Capacity: 12 L
- Weight: 110 lbs.
- Overall Height: 20"
- Overall Width: 16-1/2"
- Overall Depth: 26-1/2"
- Surge Power: 4500 W
- Running Wattage: 3700 W
- AC Outputs: (2) 120V/20 A, (1) 120V/30 A
- DC Output: 12 V
- Engine (OHV): 8 HP
- No Load Speed: 3600 RPM
- Displacement: 224 CC
- Oil Capacity: 0.6 L
- Run Time: 11-12 hrs.
- Noise Level: 64 dB(A)



Model No.	Mfg. No.	Price /Each
UAV630	KCG-4500I	1667.00

GENERATOR EXTENSION CORDS

- These extension cords convert a Nema L14-30P 240 V 30 Amp Twist Lock plug into Nema 5-15/20R 120 V RV adaptor
- Colour: Red
- No. of Outlets: 4
- Trade Designation: SJTW
- No. of Conductors: 4



XE667



TMA072



XE668

Model No.	Mfg. No.	Description	Gauge AWG	Length'	Amps	Price /Each
TMA072	K-L1430-10	Extension Cord	12/3	10	30 A	52.10
XE667	K-L1430R-25	Extension Cord with Resets	10	25	20 A	132.00
XE668	K-L1430-25-4T	Extension Cord with Quad Tap	10	25	20 A	132.00



IQ3500 INVERTER GENERATOR

- Advanced inverter technology and enclosure design provide optimal quiet performance
- Durable steel enclosure, clean inverter power, easy portability
- Electric start means hassle free startup (battery included)
- Choke, Run and Stop are all integrated into one easy PowerDial™
- Features a digital wattage meter, run time remaining display, generator status, hour meter, fuel level, and USB ports
- Fuel Tank Capacity: 10 L
- Overall Dimensions: 18" W x 23-7/10" D x 21-7/10" H
- Surge Power: 3500 W
- Rated Power: 3000 W
- AC Voltage: 120
- Engine Displacement: 212 CC



GENERAC®

Model No.	Price /Each
XI278	1799.00

PORTABLE POWER STATION

- Clean, emission-free, portable power allows users to take it anywhere, indoors or outside
- Recharge from 0 to 80% in 2.1 hours from a wall outlet
- Supports input from solar, car, and generator
- Combine charging methods for even faster recharge times
- Lightweight and easy to use with durable enclosure, ergonomic handle, and on-board storage
- Features a 15W wireless charging pad for compatible devices
- A large 4.7" multi-colour display allows users to view the charge level, remaining runtime, and other key info at-a-glance
- Fast solar charging with built-in MPPT controller
- Solar panels sold separately
- Overall Dimensions: 10-2/10" W x 14-1/10" D x 12" H
- Battery Type: Lithium Ion
- Wattage: 3200 W
- AC Wall Charger Input: 120V AC (60Hz)
- DC/Solar Charger Input: 10-28 VDC (30A)
- Nameplate Capacity: 1086 Wh
- Cycle Life: 800 Cycles to 80% Capacity
- Shelf Life: Charge Every 3-6 Months
- Manufacturer's Warranty: 3-Year Limited (Residential), 1-Year Limited (Commercial)
- Includes: AC Charger Cord, Car Charger Cord, Solar Adapter Cord

GENERAC®



Model No.	Price /Each
NAA169	1450.00

GP SERIES 6500 PORTABLE GENERATOR

- The Generac OHV engine incorporates splash lubrication and provides long life
- Large-capacity steel fuel tank with incorporated fuel gauge provides durability and extended run times
- Low-oil level shutdown automatically safeguards engine from damage
- Hardened 1-1/4" steel tube cradle for added strength and durability
- Hour meter tracks usage for proper service intervals
- Heavy-duty, never flat wheels for reliable portability
- Covered outlets provides added protection from the environment and rugged working conditions
- Fuel Tank Capacity: 7.2 gal.
- Overall Dimensions: 27" W x 27-1/4" D x 25" H
- Surge Power: 8125 W
- Rated Power: 6500 W
- Voltage Output: 120 V, 240 V



GENERAC®

Model No.	Price /Each
XH537	1579.00

M18™ CARRY-ON™ POWER SUPPLY

- Eliminate the cost of gasoline, repairs, and maintenance required with a gas generator
- Keep noise to a minimum onsite with a quiet power supply at 66 dBA
- Delivers 3600 W/1800 W for aggressive 15 A applications with 4 M18™ Batteries
- Run demanding tools like table saws, compressors, and pipe threaders
- Recharge sensitive electronics with a pure sine wave inverter with USB-C PD & USB-A
- Lightweight and compact form factor allows users to have power by their side
- Bring the Carry-On™ indoors, into confined spaces, utility carts, and lifts
- Overall Dimensions: 12-1/4" W x 15" D x 13-3/4" H
- Battery Type: Lithium Ion



Model No.	Mfg. No.	Price /Each
AUW253	2845-20	899.00

MULTIMETERS & VOLTAGE TESTERS



STUD, METAL & VOLTAGE DETECTOR

- Find studs, metal and detect the presence of AC voltage with this 3-in-1 multi-scanner
- Features an LCD display with bar graph allowing for quick and accurate detection
- Ergonomically designed for comfort and grip
- Auto power-off after 20 seconds
- Max. Depth Scanned: 2-4/7"
- Alert Type: Display
- Stud Detection Depth: Up to 0.98" (25mm)
- Metal Detection Depth: Up to 2.56" (65mm)
- Voltage Detection Depth: Up to 1.96" (50mm)
- Low Battery Indicator: Yes
- Power Supply: 9V Battery
- Operating Temperature: 19.4 to 104°F (-7 to 40°C)
- Storage Temperature: -4 to 122°F (-20 to 50°C)



REED

Model No.	Mfg. No.	Description	Price /Each
IB898	R9090	Stud, metal & Voltage Detector	39.00

NON-CONTACT AC VOLTAGE DETECTOR WITH FLASHLIGHT

- Provides the ability to detect the presence of AC voltage from a safe distance
- Features two voltage ranges allowing it to detect both high (90 to 1000 V) and low (24 to 1000 V) AC voltage wiring
- Suitable for receptacles or against insulated wire
- Double insulated housing for increased safety
- Audible (buzzer) and visual (LED) indicators
- Built-in flashlight
- Pocket clip
- Auto shut off
- Includes: (1) Non-contact AC voltage detector, (2) AAA batteries
- Overvoltage Category: CAT. IV 1000V
- Certification(s): CE, ETL



REED

Model No.	Mfg. No.	Description	Price /Each
IC766	R5110	Non-Contact AC Voltage Detector with Flashlight	25.00

TRUE RMS WATT METER

- True RMS AC current and voltage measurements; measures Watt (AC), AC A, AC V, and pF
- Large dual LCD display with backlight
- Full function auto range
- Max./Min. Record
- Data Hold
- Low battery indicator
- Max. Voltage: 660 V
- Maximum Amperage: 10 A
- Watt - Range: 6000 W
- Power Factor - Range: 1
- Power Supply: 1 x 9V battery
- **Includes:** Watt Meter, Pair of Test Leads (red & black), Battery



HN416

IB824

REED

Model No.	Mfg. No.	Description	Price /Each
IB824	R5000	Watt Meter	409.00
IB742	R8888	Deluxe Carrying Case	89.00
HN416	CA-05A	Carrying Cases	32.00
IA707	FC-300	Fused Test Lead Sets	39.00

NON-CONTACT VOLTAGE & MAGNETIC FIELD DETECTOR

- AC voltage and magnetic field detector with built-in flashlight
- Check receptacles or insulated wire for presence of AC voltage
- Quickly determine the presence of magnetic fields to determine whether or not components are working properly
- Double insulated housing for increased safety
- Audible (buzzer) and visual (LED) indicators
- Built-in flashlight
- Pocket clip
- Auto shut-off
- Two voltage ranges allow it to detect both high (90 to 1000 V) and low (24 to 1000 V) AC voltage wiring
- Voltage Detection: 24 VAC - 100 VAC, 90 VAC - 1000 VAC
- Power Supply: (2) AAA Batteries
- Overvoltage Category: CAT. IV 1000V
- Certification(s): CE, IP67, ETL (Conforms to UL STD 61010-1, 61010-2-030, Certified to CSA STD C22.2 No. 61010-1, 61010-2-030)



REED

Model No.	Mfg. No.	Description	Price /Each
IC856	R5120	Non-Contact Voltage & Magnetic Field Detector	30.00

LCR/CAPACITANCE METERS

- Measure inductance/capacitance/resistance with secondary parameters including dissipation factor (D), quality factor (Q), phase angle (Ø), equivalent series/parallel resistance (ESR or Rp)
- Autoranging operation for AC impedance and DE resistance measurement
- Auto LCR smart check and measurement
- Series/Parallel modes
- Ls/Lp/Cp with D/Q/Ø/ESR parameters
- Support DCR mode 200 to 200MΩ
- High accuracy with 4 or 5 terminal Kelvin measurement
- Testing frequency is up to 10kHz and output frequency is up to 100kHz
- Includes test leads and batteries
- Accredited calibration available



REED

SPECIFICATIONS:

Inductance Range: 2000.0 µH/20.000/200.0/2000.0 mH/20.000/200.00/2000.0 H
Capacitance Range: 2000.0 pF/20.000/200.00/2000.0 nF/20.00/200.00/2000 µF
Resistance Range: 20.000/200.00 Ω/2.0000/20.000/200.00 kΩ/2.0000/20.000/200.0 MΩ
Test Frequencies: 100/120/1k/10k/100k Hz

Model No.	Mfg. No.	Description	Price/Each
IA854	R5001	LCR/Capacitance Meter	329.00
NJW155	R5001-NIST	LCR/Capacitance Meter w/ISO Certificate	559.00

POWER METER

- Calculates operating costs of household appliances
- Displays 8 important units of measure—Voltage, Current, Watts, Frequency, Power Factor, Energy used (kWh), Total Cost and Elapsed Time
- Easy-to-read, dual LCD display
- Built-in battery backup
- Conforms to UL and CSA standards
- Voltage Readings: AC
- Current Readings: AC
- Product Certifications: CE, ETL, Conforms to UL STD.61010-1, 61010-2-030; Certified to CSA STD.C22.2 NO.61010-1, 61010-2-030
- **Includes:** Power Meter and Battery



REED

Model No.	Mfg. No.	Description	Price /Each
IB903	R5090	Power Meter	59.00

MULTIMETERS & VOLTAGE TESTERS

RECEPTACLE TESTER WITH GFCI

- Tests whether the outlet is properly wired
- Can perform the entire array of tests by simply plugging the device into the outlet
- Easy to read light pattern chart
- Detects most common 3-wire receptacle issues
- LED indicators identify 5 wiring faults
- Status indicator chart
- GFCI trip test
- Voltage: 110 - 125V AC
- Frequency Range: 50 - 60Hz
- Maximum Current: 15 A
- Certification(s): CE, UL



REED

Model No.	Mfg. No.	Description	Price /Each
IC455	RS210	Receptacle Tester	15.00

CONTINUITY TESTER

- Lightweight design connects with alligator clips and the instrument suspends from cable
- Local and remote continuity tester
- Probe flashes green or red to indicate polarity
- Display Type: Indicator Light
- Wire Verification Distance: 10000 feet (3000 meters)
- Minimum Wire Size: 26 gauge
- Power Supply: 9 V Battery
- Visual Indicator: Yes (green and red LEDs)
- Audible Indicator: Yes (Pulsating Beeper, approx. 85 dB)
- Fuse: 0.5A/250V
- Operating Temperature: 14 to 113°F (-10 to 45°C)



REED

Model No.	Mfg. No.	Description	Price /Each
IB868	RS300	Continuity Tester	35.00

TRUE RMS DIGITAL MULTIMETER

- Measures AC/DC voltage and current, frequency, resistance, capacitance and temperature
- Built-in non-contact voltage detector and double molded plastic housing
- Diode check and continuity functions
- Relative and data hold functions
- Backlit LCD and low battery indicator
- Cat. III 600V safety rating
- Voltage Readings: AC/DC
- Current Readings: AC/DC
- Range Selection: Autoranging/Manual
- Display: 6,000 count LCD display
- Continuity Check: Audible signal if resistance $\leq 10\Omega$
- Duty Cycle: Yes (0.1-99.9%)
- Auto Power Off: Yes (after 15 minutes)
- Power Supply: 2 x AA batteries
- Overvoltage Category: CAT. III 600V
- Product Certification: CE



REED

Model No.	Mfg. No.	Description	Price/Each
IB825	RS007	Multimeter	119.00

COMPACT MULTIMETER WITH NON-CONTACT VOLTAGE

- Measures AC/DC voltage and current, resistance, capacitance, frequency, diode and continuity
- Built-in non-contact voltage detector and double molded plastic housing
- 4,000-count backlit LCD display
- Low battery indicator and auto shut-off
- CAT III 600V safety rating
- Includes: Multimeter with NCV, Test leads, Batteries
- Voltage Readings: AC/DC
- Current Readings: AC/DC
- AC Voltage Range: 4, 40, 400, 600V
- DC Voltage Range: 400mV, 4, 40, 400, 600V
- AC/DC Current Range: 400 μ A, 4, 40, 400mA
- Resistance Range: 400 Ω , 4, 40, 400k Ω , 6, 40M Ω
- Capacitance Range: 50, 500nF, 5, 50, 100 μ F
- Frequency Range: 9.999Hz to 60kHz
- Product Certifications: CE
- Operating Temperature: 32 to 104°F (0 to 40°C)
- Dimensions: 4.4 x 2.3 x 1.4" (112 x 58 x 35mm)



REED

Model No.	Mfg. No.	Description	Price/Each
IC695	RS099	Multimeter	55.00

MILLI-OHMMETER

- 4 terminal input for high accuracy of low resistance
- LSI circuitry provides high accuracy, reliability and durability
- Built-in overload protection
- Large LCD display
- Dimensions: 6-5/16" x 4-11/16" x 3-5/16"



REED

Model No.	Mfg. No.	Measuring Range	Max. Current Output mA	Price /Each
HM645	K5090	0.1 - 2000 m Ω	100	539.00

DIGITAL MULTIMETERS

- True RMS AC/DC voltage and current measurements
- 0.05 % basic DC accuracy
- 40 000-count resolution
- Measures frequency, capacitance and temperature
- Diode check and continuity test
- Backlit LCD readout with analog bar graph
- 1000 V input protection on all ranges
- 4-20 mA process loop measurements with % readout
- Data hold, Max/Min recording mode
- Peak capture mode
- IP67 dust and waterproof
- EN61010-1 Cat. IV 600 V, Cat. III 1000 V safety rating
- Includes test leads and 9 V battery

SPECIFICATIONS:

AC/DC Voltage Range:	1000 V
Accuracy:	AC: $\pm 1.0\%$; DC: $\pm 0.05\%$
AC/DC Current Range:	10 A
Accuracy:	AC: $\pm 1.5\%$; DC: $\pm 1.0\%$
Resistance Range:	40 M Ω
Accuracy:	$\pm 0.3\%$
Frequency Range:	10 MHz
Accuracy:	$\pm 0.1\%$
Capacitance Range:	40 mF
Accuracy:	$\pm 3.5\%$
Duty Cycle Range:	99.9%
Accuracy:	$\pm 1.2\%$
Temperature Range:	760°C (1400°F)
Accuracy:	$\pm 1.0\%$
Dimensions:	182 x 82 x 55 mm
Weight:	360 g



REED

Model No.	Mfg. No.	Description	Price/Each
XC308	RS010	Digital Multimeter	179.00
IA707	FC-300	Fused Test Lead Sets	39.00
IA184	CP-09	Ac Current Clamp-On Adapters	32.00
HN413	CA-52A	Carrying Case	30.00

MULTIMETERS & VOLTAGE TESTERS



TEMPERATURE COMBINATION KIT

- Includes: **IA406** compact digital multimeter with temperature, **IB537** compact infrared thermometer, **IA976** non-contact AC voltage detector with flashlight, **HX358** thermocouple adapter, **HK953** beaded thermocouple wire probe, **IA181** safety test lead set and **IB742** deluxe hard carrying case

Model No. **IB871**
Mfg. No. **RTEMP-KIT**
Price/Each **\$269.00**

REED



INDUSTRIAL COMBO KIT

- Includes: **XC308** True RMS waterproof digital multimeter, **IA982** AC clamp meter, **IB537** compact infrared thermometer, **IA976** non-contact AC voltage detector with flashlight, **HX358** thermocouple adapter, **HK953** beaded thermocouple wire probe, **IA181** safety test lead and **IB872** deluxe hard carrying case

Model No. **IB870**
Mfg. No. **RINDUST-KIT**
Price/Each **\$475.00**

REED



ELECTRICAL TROUBLESHOOTING KIT

- Plug the transmitter into a receptacle and scan breaker box to identify the circuit
- Detects 5 3-wire receptacle wiring faults
- Built-in GFCI receptacle check function
- Adjustable sensitivity wheel quickly identifies breaker
- Audible (buzzer) and visual (LED) indicators assist in identification
- Display Type: Indicator Light
- Voltage Range: 90 to 120V AC
- Bandwidth: 47 to 63Hz
- Power Supply: 9V Battery

Model No. **IB869**
Mfg. No. **R5500-KIT**
Price/Each **\$139.00**

REED



MULTIMETER COMBO KIT

- IA406** autoranging digital multimeter with temperature function
- HX394** AC/DC current clamp meter with temperature function
- IA976** non-contact voltage detector with built-in flashlight
- HX358** temperature input adapter with **HK953** type K thermocouple wire probe
- HX357** AC line splitter
- IA181** safety test leads
- IA707** fused test leads set
- IA434** carrying case

Model No. **IA658**
Mfg. No. **ST-MULTIKIT**
Price/Each **\$409.00**

REED



ELECTRICAL TEST KIT

- Kit includes the tools to troubleshoot common electrical problems (digital multimeter, AC voltage detector, receptacle tester and soft carrying case)
- Pocket-sized digital multimeter measures AC/DC voltage and current, resistance, frequency, capacitance and duty cycle
- Designed to fit into the palm of your hand
- AC Voltage Range: 4, 40, 400, 600 V
- DC Voltage Range: 400mV, 4, 40, 400, 600 V
- AC Accuracy: 4, 40, 400V $\pm(1.2\% \text{ rdg.} + 3 \text{ dgt.})$, 600V $\pm(1.5\% \text{ rdg.} + 5 \text{ dgt.})$
- DC Accuracy: 400mV $\pm(0.8\% \text{ rdg.} + 3 \text{ dgt.})$, 4, 40, 400V $\pm(0.8\% \text{ rdg.} + 1 \text{ dgt.})$, 600V $\pm(1\% \text{ rdg.} + 3 \text{ dgt.})$
- AC Resolution: 1, 10, 100mV, 1 V
- DC Resolution: 0.1, 1, 10, 100mV, 1 V
- AC/DC Current Range: 400, 4000 μ A, 40, 400 mA
- Resistance Range: 400 Ω , 4, 40, 400k Ω , 4, 40 M Ω
- Capacitance Range: 4, 40, 400nF, 4, 40, 100 μ F

Model No. **IC697**
Mfg. No. **R5099-KIT**
Price/Each **\$109.00**

REED



ENVIRONMENTAL METER KIT

- Measures relative humidity, air velocity, light levels and temperature with a type J/type K thermocouple thermometer
- Real time data logger with integral 2GB SD memory card (optional)
- Air velocity is measured in m/s, ft/min, km/h, mph or knots
- Light levels are measured in ftc or lux
- Includes: Data Logging Environmental Meter, 16GB Micro SD memory card with adapter, AC power adapter
- Light Range: 0 - 20000 lux
- Humidity Range: 5% - 95% RH
- Air Velocity Range: 0.4 - 25 m/s
- Temperature Range (Type J): -50° - 1200°C
- Temperature Range (Type K): -50° - 1300°C

Model No. **IC710**
Mfg. No. **R4700SD-KIT**
Price/Each **\$399.00**

REED



CLAMP METERS & INSULATION TESTERS

TRUE RMS AC/DC CLAMP METER

- Measures AC/DC current, AC/DC voltage, resistance, capacitance, frequency, duty cycle, and temperature with a type K thermocouple probe
- True RMS AC measurements
- Non-contact AC voltage detector in clamp tip
- Low battery indication and auto power-off
- 50 000 count LCD with backlight
- Conforms to EN61010 Cat. III 600 V
- Jaw opening: 1.2" (30 mm)
- Includes set of test leads, temperature probe, batteries, and soft carrying case



SPECIFICATIONS:

AC/DC Current Range:	50.00, 500.0 A
Accuracy:	AC: $\pm(2.8\% \text{ rdg.} + 30 \text{ dgt.})$; DC: $\pm(2.5\% \text{ rdg.} + 30 \text{ dgt.})$
AC Voltage Range:	500.00 mV, 5.0000, 50.000, 500.00, 750.0 V
Accuracy:	$\pm(1.0\% \text{ rdg.} + 30 \text{ dgt.})$
DC Voltage Range:	500.00 mV, 5.0000, 50.000, 500.00, 1000.0 V
Accuracy:	$\pm(0.1\% \text{ rdg.} + 4 \text{ dgt.})$
Resistance Range:	500.00 Ω , 5.000, 50.000, 500.00 k Ω , 5.0000, 50.000 M Ω
Accuracy:	$\pm(1.0\% \text{ rdg.} + 4 \text{ dgt.})$
Frequency Range:	10.000 kHz
Accuracy:	$\pm(0.5\% \text{ rdg.} + 10 \text{ dgt.})$
Capacitance Range:	500.00, 5000.0 nF, 50.000, 500.0 μ F, 5.000 mF
Accuracy:	$\pm(3.5\% \text{ rdg.} + 10 \text{ dgt.})$
Temperature Range:	-100.0 to 1000.0°C/-148.0 to 1832.0°F

REED

Model No.	Mfg. No.	Description	Price/Each
IB685	R5030	True RMS AC/DC Clamp Meter	179.00
NJW167	R5030-NIST	True RMS AC/DC Clamp Meter w/ISO Certificate	284.00
IA707	R1020	Fused Test Lead Sets	39.00

INSULATION TESTERS

- Measurements from 500 V to 5000 V and up to 60 G Ω
- Sources up to 1.2 mA current during tests to offset capacitance load
- Dielectric absorption ratio measurements (DAR)
- Polarization index measurement (PI)
- Time set measurement function
- Auto-discharge function and voltage output warning function
- Live circuit warning symbols plus audible warning
- Live circuit detection prevents insulation test if >30 V is detected
- Max/Min, Peak, Relative value and Data Hold functions
- 6000-count digital display with bargraph and backlight
- Meets IEC61010-1 Cat. IV 600 V safety standards
- Includes test leads, batteries and carrying case
- Accredited calibration available



REED

SPECIFICATIONS:

Insulation Resistance Test Voltages:	500 V, 1000 V, 2500 V, 5000 V DC
Insulation Resistance Range:	0 to 60.0 G Ω
Resistance Test Range:	0.1 to 6000 Ω
Voltage Range:	0.5 to 600.0 V AC/DC

Model No.	Mfg. No.	Description	Price/Each
IA855	R5002	Insulation Tester	995.00
NJW156	R5002-NIST	Insulation Tester w/ISO Certificate	1165.00

AC/DC CLAMP METER

- Measures AC current, AC and DC voltage, resistance, capacitance, as well as temperature with the included Type K thermocouple probe
- Diode test and continuity check
- 4000-count LCD displays low battery and overrange indications
- UL approved
- Cat. III 600V safety rating
- Includes one set of test leads, one temperature probe, batteries, and a soft carrying case



SPECIFICATIONS:

AC Current Range:	40.00, 400.0 A
Accuracy:	$\pm(2.5\% \text{ rdg.} + 8 \text{ dgt.})$
DC Voltage Range:	400.0 mV, 4.000, 40.00, 400.0, 600.0 V
Accuracy:	$\pm(1.5\% \text{ rdg.} + 2 \text{ dgt.})$
AC Voltage Range:	4.000, 40.00, 400.0, 600.0 V
Accuracy:	$\pm(1.8\% \text{ rdg.} + 8 \text{ dgt.})$
Resistance Range:	400.0 Ω , 4.000, 40.00, 400.0 k Ω , 4.000, 40.00 M Ω
Accuracy:	$\pm(1.5\% \text{ rdg.} + 2 \text{ dgt.})$
Capacitance Range:	40.00, 400.0 nF, 4.000, 40.00, 100.0 μ F
Accuracy:	$\pm(3\% \text{ rdg.} + 5 \text{ dgt.})$
Temperature Range:	-20.0 to 760.0°C (-4.0 to 1400.0°F)
Accuracy:	$\pm(3\% \text{ rdg.} + 5^\circ\text{C}/9^\circ\text{F})$
Jaw Opening:	1.2" (30 mm) maximum
Power Supply:	2 x 1.5V "AAA" batteries
Dimensions:	200 x 66 x 37 mm
Weight:	205 g

REED

Model No.	Mfg. No.	Description	Price/Each
IA982	R5020	AC/DC Clamp Meter	99.00
NJW166	R5020-NIST	AC/DC Clamp Meter w/ISO Certificate	204.00
IA707	R1020	Fused Test Lead Sets	39.00

INSULATION TESTERS

- Test voltage combinations: 250 V, 500 V or 1000 V
- 1 mA test current for M Ω range at rated voltage
- 200 mA test current for continuity range
- Continuity test with beeper
- Large, easy-to-read dual display with backlight
- Data hold switch
- Test button may be locked on for hands-free operation
- Double moulded plastic housing
- Supplied with test leads, batteries and plastic carrying case
- Meets IEC61010-1 Cat. III 1000 V

SPECIFICATIONS:

Insulation resistance tests	
Test Voltage:	250 V, 500 V, 1000 V
Measurement Range:	200 M Ω , 2000 M Ω
Accuracy:	$\pm 3.5\% \text{ rdg.} \pm 5 \text{ dgt.}$
Resistance tests	
Measurement Range:	200 Ω , 2000 Ω
Accuracy:	$\pm 1\% \text{ rdg.} \pm 2 \text{ dgt.}$
Voltage tests	
Measurement Range:	750 VAC; 1000 VDC
Accuracy:	AC: $\pm 1.2\% \text{ rdg.} \pm 10 \text{ dgt.}$ DC: $\pm 0.8\% \text{ rdg.} \pm 3 \text{ dgt.}$
Continuity tests	
Measurement Range:	Beeps $\leq 40 \Omega$
Test Current:	$\leq 200 \text{ mA}$
General	
Power Supply:	6 x 1.5 V AA batteries
Dimensions:	200 x 92 x 50 mm
Weight:	700 g

REED

Model No.	Mfg. No.	Description	Price/Each
IA194	R5600	Insulation Tester	279.00
NJW171	R5600-NIST	Insulation Tester w/ISO Certificate	414.00



PROCESS METERS & DECADE BOXES



RESISTANCE DECADE BOX

- 3 binding posts permit isolated substitutions
- Slide switches that allow user to simply add or subtract for desired value
- Excellent for circuit development
- Resistance Test Range: 1 Ω to 11 MΩ
- Resolution: 1 Ω increments
- Accuracy: ±1% of reading
- Dimensions: 4-19/32" x 5-13/16" x 2"



CAPACITANCE DECADE BOX

- Excellent for circuit development
- Features slide switches that allow a user to easily add or subtract to quickly reach the desired capacitance range
- 3 binding posts permit isolated substitutions
- Durable construction
- 5 decade ranges of capacitance
- Capacitance Test Range: 100 pF to 11111 μF
- Resolution: 100 pF per step



REED

Model No.	Mfg. No.	Description	Price/Each
HX310	R5408	Resistance Decade Box	159.00
IB907	R5408-NIST	Resistance Decade Box (Includes ISO Certificate)	389.00

REED

Model No.	Mfg. No.	Description	Price/Each
IB905	R5406	Capacitance Decade Box	199.00

CARRYING CASES

PROTECT & STORE YOUR MULTIMETER & ACCESSORIES IN A CARRYING CASE



HN416



IA434



HN413



IB742



IB743

REED

Model No.	Mfg. No.	Outside Dimensions L" x W" x D"	Price /Each
IA434	C-833R	11 x 9 x 2	30.00
HN416	CA-05 A	9 x 4 x 2	32.00
HN413	CA-52 A	7 x 3 x 2	30.00
IB742	R8888	13 x 12 x 5.8	89.00
IB743	R9999	15.8 x 7.8 x 11.8	69.00
IB872	R8890	15.7 x 12.6 x 6.7	119.00

MEDIUM CARRYING CASE

- Hard outer shell protects items
- Accommodates small to medium sized instruments
- Built-in compartment stores instrument accessories
- Soft interior lining
- External Dimensions: 8.75 x 6.5 x 2.25" (222.25 x 165.10 x 57.15 mm)



INFRARED THERMOMETER CARRYING CASE

- Soft Carrying Case for REED R2001, R2002 and FS-200 infrared thermometers
- Accommodates up to 3 small-to-medium sized instruments
- Interior accessory pocket and removable hook and loop partitions
- Adjustable shoulder strap
- Made of polyester
- Internal Dimensions: 11 x 9 x 1.5" (279 x 228 x 38mm)
- External Dimensions: 11.5 x 9.5 x 2" (292 x 241 x 51mm)



REED

Model No.	Mfg. No.	Description	Price/Each
IC784	R9940	Medium Carrying Case	22.00

REED

Model No.	Mfg. No.	Description	Price/Each
IB925	R9990	Infrared Thermometer Carrying Case	24.00

VAULT CARRYING CASES

- Five layers of protective foam
- Crushproof, dustproof, and weather-resistant
- High-impact polymer assures protection of your gear and accessories
- Heavy-duty handles are ergonomic and will stand up in even the toughest conditions
- Stainless steel lock hasps afford extra security during transport
- Push button latches offer secure closure with easy-open access
- Colour : Black



IB930



IB933



IB935



IB939



Model No.	Mfg. No	No. of Latches	Inside Dimensions			Outside Dimensions			Weight lbs.	Price /Each
			L"	W"	H"	L"	W"	H"		
IB930	V100	2	11	8	4.5	12.28	12.03	5.16	3.5	74.90
IB931	V200	2	14	10	5.5	15.41	13.08	6.16	5	119.00
IB933	V300	2	16	11	6.5	17.54	14.21	7.16	6.7	129.00
IB934	V550	4	19	14	8.5	22.42	17.46	9.16	10.7	199.00
IB935	V600	4	21	17	9.5	24.55	20.59	10.16	15.3	239.00
IB936	V700	6	36.5	14.5	6	39.61	17.65	6.65	16.3	255.00
IB937	V730	6	44	16	6.25	47.12	19.18	6.9	22	309.00
IB938	V770	4	50	10	6	51.47	13.15	6.65	16.1	255.00
IB939	V800	6	53	16	6	56.11	19.15	6.65	25	345.00

AIR CARRYING CASES

- Molded from the next generation of Pelican's lightweight HPX™ resin
- Features honeycomb structural elements that are actually stronger than solid polymer material
- Automatic purge valve keeps water and dust out while balancing air pressure
- Includes foam



IC229



IC238



IC235



IC239



Model No.	Mfg. No	No. of Latches	Inside Dimensions			Outside Dimensions			Weight lbs.	Price /Each
			L"	W"	H"	L"	W"	H"		
IC229	1485	2	17.75	10.18	6.15	19.17	12.80	6.89	5.4	359.00
IC230	1507	2	15.15	11.38	8.52	16.87	14.10	9.27	6.4	369.00
IC231	1525	2	20.50	11.31	6.75	21.96	13.97	7.49	7.1	379.00
IC232	1535	2	20.39	11.20	7.21	21.96	13.97	7.49	10	495.00
IC233	1555	3	23.00	12.75	7.50	24.76	15.46	8.24	9	445.00
IC234	1557	2	17.33	13.00	9.75	19.18	15.79	10.50	8.2	445.00
IC235	1605	5	26	14	8.4	28.87	16.77	9.12	11.6	559.00
IC236	1607	4	21.1	15.8	11.6	24.13	18.80	13.25	16.1	649.00
IC237	1615	5	29.6	15.5	9.4	32.58	18.40	11.02	17.6	669.00
IC238	1637	5	23.4	17.6	13.3	26.61	20.65	14.87	19.4	759.00
IC239	1745	6	44	16.8	7.9	46.69	19.36	8.73	21.1	759.00

VAULT OD GREEN COLOURWAY CASE

- Crushproof high-impact polymer
- Weather-resistant, dustproof
- Locking hasps
- Push-button latches
- Heavy-duty handles
- Case Type: Hard Case
- Weight (with Foam): 3.47 lbs.
- Manufacturer's Warranty: 3 Years



Model No.	Mfg. No.	Dimensions			Price /Each
		L"	W"	D"	
IC850	VCV100-0020-ODG	12.28	12.03	5.16	74.90

MOVING YOU FORWARD

KLETON

EQUIPMENT CASES

PELICAN PROTECTOR EQUIPMENT CASES

Light, strong, watertight and airtight for the ultimate protection. Constructed of copolymer and polypropylene. Features a 1/4" neoprene O-ring seal and a purge valve. Supplied complete with pre-scored pick & pluck foam or padded dividers (no cutting required). Custom foam insert fabricated on special order. Also includes ABS locking flanges, massive multiple latches and a comfortable molded grip handle.

Note: Models HA597 and HA603 supplied with solid foam only.

- Other colours available for Mfg. No. 1700 to 1750 are desert tan and green
- Other colours available for Mfg. No. 1200 to 1600 are silver, desert tan and green



FEATURES:

O-Ring Seal: Exclusive 1/4" neoprene O-ring guarantees a perfect seal. Neither dust nor water can penetrate this barrier to damage your equipment. These rings are easily replaced if damaged.

Purge Valve: All cases are absolutely airtight. Exclusive built-in O-ring sealed pressure purge valve allows for quick equalization after changes in temperature or altitude.



MODEL NO. HA292

Outside Dimensions:
10 5/8" L x 9 11/16" W x 4 7/8" D
Inside Dimensions:
9 1/4" L x 7 1/8" W x 4 1/8" D
Fold-down handle.
Weight: 2.87 lbs.

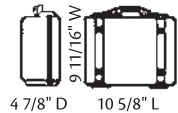

MODEL NO. HA419

Outside Dimensions:
10 5/8" L x 9 11/16" W x 6 7/8" D
Inside Dimensions:
9 1/8" L x 7" W x 6 1/8" D
Fold-down handle.
Weight: 3.53 lbs.

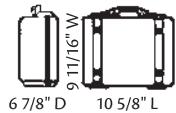

MODEL NO. HA450

Outside Dimensions:
13 3/8" L x 11 5/8" W x 6" D
Inside Dimensions:
11 13/16" L x 8 7/8" W x 5 3/16" D
Fold-down handle.
Integral personalised nameplate.
Weight: 4.41 lbs.

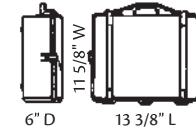

MODEL NO. HA501

Outside Dimensions:
18 1/2" L x 14 1/16" W x 6 15/16" D
Inside Dimensions:
16 3/4" L x 11 3/16" W x 6 1/8" D
Fold-down handle.
Integral personalised nameplate.
Weight: 7.05 lbs.

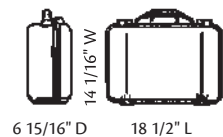

MODEL NO. HM576

Outside Dimensions:
19.78" L x 15.77" W x 7.41" D
Inside Dimensions:
18.06" L x 12.89" W x 6.72" D
Fold-down handle.
Weight: 9.35 lbs.

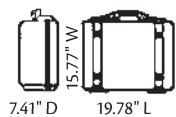

MODEL NO. HA510

Outside Dimensions:
20 5/8" L x 16 7/8" W x 8 1/8" D
Inside Dimensions:
18 7/16" L x 14" W x 7 5/8" D
Fold-down handle.
Integral personalised nameplate.
Weight: 11.9 lbs.

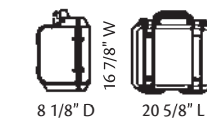

MODEL NO. HA536

Outside Dimensions:
24 1/4" L x 19 7/16" W x 8 11/16" D
Inside Dimensions:
21 7/16" L x 16 1/2" W x 7 7/8" D
Fold-down handle.
Integral personalised nameplate.
Weight: 14.11 lbs.

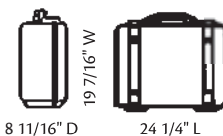

MODEL NO. HA597

Outside Dimensions:
38 1/8" L x 16" W x 6 1/8" D
Inside Dimensions:
35 3/4" L x 13 1/2" W x 5 1/4" D
Fold-down handle.
Weight: 16.98 lbs.

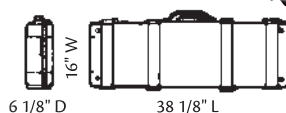

MODEL NO. HA603

Outside Dimensions: 53" L x 16" W x 6 1/8" D
Inside Dimensions: 50 1/2" L x 13 1/2" W x 5 1/4" D
Fold-down handle.
Weight: 25.57 lbs.

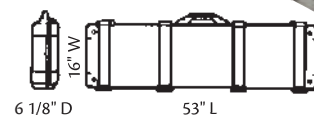

PROTECTIVE CASES

Black Model No.	Orange Model No.	Mfg. No.	Description	Price /Each
HA292	HA293	1200	1200 Case	129.00
HA419	HA420	1300	1300 Case	149.00
HA450	HA451	1400	1400 Case	229.00
HA501	HA502	1500	1500 Case	339.00
HM576	-	1520	1520 Case	375.00
HA510	HA511	1550	1550 Case	419.00
HA536	HA537	1600	1600 Case	495.00
HA597	-	1700	1700 Case	595.00
HA603	-	1750	1750 Case	705.00

FOAM INSERTS

Model No.	Mfg. No.	Description	Price/Each
HA296	1201	3-pc. foam insert for HA292, HA293	45.50
HA423	1301	3-pc. foam insert for HA419, HA420	52.90
HA460	1401	3-pc. foam insert for HA450, HA451	73.90
HA503	1501/A	3-pc. foam insert for HA501, HA502	105.00
HA512	1551	4-pc. foam insert for HA510, HA511	159.00
HA538	1601	4-pc. foam insert for HA536, HA537	219.00
HA599	1701	3-pc. foam insert for HA597, HA598	199.00
HA605	1751	4-pc. foam insert for HA603	199.00



THERMAL IMAGING CAMERA

- Features a rugged IP65-rated double-molded housing and a 160 x 120 9Hz infrared sensor with 0.05°C thermal sensitivity
- Has the ability to display hot and cold spot temperatures on a 2.8" color LCD and allows a user to choose from 7 different color palettes
- The included software allows a user to view and analyze data, and generate reports or projects in real-time on a PC
- 2.8" color TFT display
- Built-in LED flashlight
- 7 colour palettes (Ironbow/Rainbow/Rainbow(HC)/Lava/Red-Hot/White-Hot/Black-Hot)
- Intuitive on-screen measurement tools
- 3 image modes (Thermal, Visual Image, Thermal Blending)
- High and Low-temperature spot and alarm indicators
- IP65 and 6.5' (2m) drop tested
- Rechargeable Li-ion battery
- Tripod mountable for continuous long-term monitoring
- View, analyze stored data, and generate reports or projects in real-time
- Low battery indication and auto shut-off
- Display Type: Built-in, Windows PC
- Includes: Thermal Imaging Camera, USB Cable, 32 GB Micro SD Card, Soft Carrying Case
- Field of View (FOV): 56 x 42°
- Optimal Focal Distance: 0.82' (0.25m)
- Detector Type: Uncooled microbolometer, Focal plane array (UFPA)
- Spectral Range: 8 to 14µm
- Emissivity: Adjustable (0.01 to 0.99)
- Digital Camera Resolution: 640 x 480 pixels



REED

Model No.	Mfg. No.	Resolution	Thermal Sensitivity	Temperature Range	Price /Each
ID031	R2165	160 x 120 pixels	50 mK	-10° - 400°C (14° - 752°F)	749.00

THERMAL IMAGING CAMERAS

- Features a 320 x 240 (76,800 pixels) infrared sensor that can detect temperatures between -40 and 752°F (-40 and 400°C)
- The R2170 has the ability to display hot and cold spot temperatures on a 3.5" color LCD and allows a user to choose from 7 different color palettes
- The included software allows a user to view and analyze data, and generate reports or projects in real-time on a PC
- The included battery packs have been designed to be easily changed in the field, allowing for continuous work
- Built-in dual LED flashlight
- Intuitive on-screen measurement tools
- 4 image modes: thermal, visual image, picture-in-picture, fusion (thermal blending)
- High and Low temperature spot and alarm indicators
- Tripod mountable for continuous long-term monitoring
- View, analyze stored data and generate reports or project in real-time
- Low battery indication and auto shut off
- Rechargeable Li-ion battery
- 4x digital zoom
- Display Type: Built-in
- Field of View: 56 x 42°
- Image Capture Frequency: 9 Hz
- Accuracy: ±3.6°F (2°C) or ±2%
- Spectral Range: 8 to 14 µm

REED



IC923

Model No.	Mfg. No.	Resolution	Display Size"	Thermal Sensitivity	Temperature Range	Price /Each
IC923	R2170	640 x 480 pixels	3.5	65 mK	-40 to 752°F (-40 to 400°C)	1795.00
IC924	R2170-NIST	320 x 240 pixels	2.8	50 mK	14 to 752°F (-10 to 400°C)	2155.00

THERMAL IMAGING CAMERA

- Features a rugged IP65-rated double-molded housing and a 160 x 120 9Hz infrared sensor with 0.05°C thermal sensitivity
- Has the ability to display hot and cold spot temperatures on a 2.8" color LCD and allows a user to choose from 7 different color palettes
- The included software allows a user to view and analyze data, and generate reports or projects in real-time on a PC
- 2.8" color TFT display
- Built-in LED flashlight
- 7 colour palettes (Ironbow/Rainbow/Rainbow(HC)/Lava/Red-Hot/White-Hot/Black-Hot)
- Intuitive on-screen measurement tools
- 3 image modes (Thermal, Visual Image, Thermal Blending)
- High and Low-temperature spot and alarm indicators
- IP65 and 6.5' (2m) drop tested
- Rechargeable Li-ion battery
- Tripod mountable for continuous long-term monitoring
- View, analyze stored data, and generate reports or projects in real-time
- Low battery indication and auto shut-off
- Temperature Range: 14° - 752°C (-10° - 400°F)
- Includes: Thermal Imaging Camera, USB Cable, 32GB Micro SD Card, Soft Carrying Case
- Emissivity: Adjustable (0.01 to 0.99)
- Digital Camera Resolution: 640 x 480 pixels

REED



Model No.	Mfg. No.	Description	Price/Each
ID031	R2165	Thermal Imaging Camera	749.00
ID032	R2165-NIST	Thermal Imaging Camera with ISO Certificate	1109.00

INFRARED THERMOMETERS



FOOD SERVICE INFRARED THERMOMETERS

- Contact and non-contact food service thermometer
- Optical Resolution: 12:1 (Distance: Spot size)
- Infrared thermometer features laser sighting
- Accepts any Type K thermocouple probe with mini-connector
- Choice of five different colour faceplates - choose a different colour faceplate for each department or food category
- Large backlit LCD readout
- Max, Min, Diff and Avg. displays
- Programmable Hi/Lo alarms
- Lock feature for continuous monitoring
- Includes holster/case

SPECIFICATIONS:

Range:	-76° to 932°F (-60° to 500°C)
Resolution:	±0.1°F (±0.1°C)
Accuracy:	±2% rdg. or ±2°C, whichever is greater
Response Time:	1 second
Spectral Response:	8 to 14 µm
Emissivity:	Preset at 0.97
Optical Resolution:	12:1 (Distance: Spot size)
Type K Thermocouple Probe Range:	-83° to 1999°F (-64° to 1400°C)
Accuracy:	±1% rdg. or ±1°C, whichever is greater
General	
Power Supply:	2 x AAA alkaline batteries
Dimensions:	175 x 39 x 72 mm (6.9 x 1.5 x 2.8")
Weight:	179 g



BIOS
Professional

Model No.	Mfg. No.	Description	Price/Each
IA432	PS200	Food Service Infrared Thermometer	245.00

INFRARED THERMOMETERS

- Built-in laser pointer identifies target area
- Digitally adjustable emissivity
- Max, min, average and differential readings
- Backlit display
- High and low alarms
- Low battery indication and auto shut-off
- Temperature Range: -25.6° - 752° F (-32° - 400° C)
- Spoty Size Ratio: 12:1
- Emissivity: Adjustable
- Accuracy: ±4°F(2°C) or ±2% rdg.



IB967

REED

Model No.	Mfg. No.	Description	Price/Each
IB967	R2300	Infrared Thermometer	79.00
IB968	R2300-NIST	Infrared Thermometer with ISO Certificate	239.00

INFRARED THERMOMETERS

- Built-in laser pointer identifies target area
- Digitally adjustable emissivity
- Max, min, average and differential readings
- Backlit display
- High and low alarms
- Low battery indication and auto shut-off
- Includes carrying case and battery
- Temperature Range: -31° - 1202° F (-35° - 650° C)
- Spoty Size Ratio: 12:1
- Emissivity: Adjustable
- Accuracy: ≥32°F (0°C):±3.6°F (1.8°C) or ±1.8% rdg., whichever is greater <32°F (0°C):±3.6°F+0.1°F (1.8°C+0.1°C)/rdg.



IB965

REED

Model No.	Mfg. No.	Description	Price/Each
IB965	R2310	Infrared Thermometer	129.00
IB966	R2310-NIST	Infrared Thermometer with ISO Certificate	289.00

FOOD SERVICE INFRARED THERMOMETER

- Specifically designed and calibrated to meet food service industry requirements
- Built-in laser pointer identifies target area
- User settable alarm, with audible/visual signals
- Green LED for normal temperature indication and red LED for high temperature indication
- Backlit LCD display
- User selectable °F or °C
- Fixed emissivity covers 90% of all applications
- Data hold, auto shut off and trigger lock
- Temperature Range: -58° - 4° F (-50° - -20° C), -4° - 392° F (-20° - 200° C)
- Spot Size Ratio: 0.334027778
- Emissivity: Fixed
- Spectral Response: 6 to 14µm
- Response Time: <1 sec
- Display Size: 1.5"
- Laser Class: Class II
- Power Supply: 9 V Battery
- Operating Temperature: 32°F to 122°F (0°C to 50°C)
- Operating Humidity Range: 10-90%

REED



NJW099

Model No.	Mfg. No.	Description	Price/Each
NJW099	FS-200	Food Service Infrared Thermometer	129.00
NJW100	FS-200-NIST	Food Service Infrared Thermometer with ISO Certificate	289.00

PROFESSIONAL INFRARED THERMOMETERS

- Includes a bright colour display for ease of use in both sunlight and dimly lit environments
- Tri-colour LEDs quickly indicate when temperatures are within set parameters (green), above (red) or below (blue)
- Built-in laser pointer identifies target area
- User selectable °F or °C
- Digitally adjustable emissivity
- Audible (beep) and visual (tri-colour LED) user adjustable alarms
- Internal memory stores up to 5 pre-set high & low alarms and 5 emissivity settings
- Trigger lock for continuous monitoring
- Features low battery indication and auto shut-off
- Temperature Range: -26 - 1472° F (-32 - 800° C)
- Spot Size Ratio: 30:1
- Emissivity: Adjustable, 0.1 - 1.0
- Response Time: 250 ms



IC114

REED

Model No.	Mfg. No.	Description	Price/Each
IC114	R2320	Infrared Thermometer	189.00
IC115	R2320-NIST	Infrared Thermometer with ISO Certificate	349.00

INFRARED THERMOMETER

- Built-in laser pointer identifies target area
- User selectable °F or °C
- Bright colour display (EBTN)
- Digitally adjustable emissivity
- Max, Min, Average and Differential readings
- Audible (beep) and visual (tri-colour LED) user adjustable alarms
- Internal memory stores up to 5 pre-set high & low alarms and 5 emissivity settings
- Trigger lock and tripod mount for continuous monitoring
- Low battery indication and auto shut off
- Includes: Infrared thermometer, Carrying case, Battery
- Temperature Range: -26° - 2282° F (-32° - 1250° C)
- Spot Size Ratio: 50:1
- Emissivity: Adjustable
- Resolution: 0.1°F (0.1°C)
- Repeatability: 0.8°C or 0.8% (1.8°F or 0.8%) Whichever is Greater
- Spectral Response: 8 to 14µm
- Response Time: 250 ms
- Power Supply: 9V Battery
- Battery Life: Approximately 10 Hours (Continuous Use With Backlight On)
- Maximum Operating Altitude: 6561' (2000 m)
- Maximum Storage Altitude: 39370' (12000m)

REED



Model No.	Mfg. No.	Description	Price/Each
IC537	R2330	Infrared Thermometer	329.00
IC539	R230-NIST	Infrared Thermometer with ISO Certificate	489.00

TYPE K THERMOCOUPLE PROBES

MODEL IB878

SURFACE THERMOCOUPLE PROBES

For general-purpose temperature applications.
Measuring Range: -58 to 932°F (-50 to 500°C).



MODEL IB879

RIGHT-ANGLE SURFACE PROBE

Unique right-angle surface probe design allows for temperature measurement of hard-to-reach areas.
Measuring Range: -58 to 932°F (-50 to 500°C).



MODEL IB880 AIR/GAS THERMOCOUPLE PROBE

Specially-designed to measure air or gases in heating units, cooling units, ovens and engine exhausts. Perforated stainless steel shield permits fast response and element protection.
Measuring Range: -58 to 1652°F (-50 to 800°C).



MODEL IB881

IMMERSION THERMOCOUPLE PROBE

Recommended for checking the temperature of water, oils and non-corrosive fluids and gels. For immersion and general-purpose applications.
Measuring Range: -58 to 1112°F (-50 to 600°C).



MODEL HN213

NEEDLE TIP PROBES

Medium gauge hypodermic needle tip, used to measure softer food stuffs, rubbers and solids. Ideal for use in industrial, laboratory and chemical environments.
Maximum Temperature: 800°C.



Model No.	Mfg. No.	Description	Price/Each
IB878	R2920	Surface Thermocouple Probes	89.00
IB879	R2930	Right-Angle Surface Probe	99.00
IB880	R2940	Air/Gas Thermocouple Probe	89.00
IB881	R2950	Immersion Thermocouple Probe	89.00
HN213	R2960	Needle Tip Thermocouple Probe	79.00

DATA LOGGING THERMOMETER WITH OVEN/FREEZER THERMOCOUPLE PROBES

- Real-time data logger with integrated SD memory card measures/records up to 4 separate temperature measurements simultaneously as well as temperature differential
- Accepts Type K, J, R, S, E, T thermocouples and RTD probes
- Features Data hold, Max/Min functions, and an easy-to-read backlit LCD display
- Quickly generate an Excel file with raw data, all without the use of software
- User selectable sampling rate from 1 to 3600 seconds
- Versatile air probe specifically designed to monitor ambient air temperatures in various food service equipment including ovens, refrigeration units, and freezers
- The R2980 features a stainless-steel shield to protect the sensor from touching surfaces and conveying a false measurement
- Includes: (1) Reed R2450SD Data Logging Thermometer, (2) Reed R2980 Type K Air Oven/Freezer Thermocouple Probes
- Operating Temperature:
 - 100 °C to +1300 °C (-148 °F to +2372 °F)
- Probe Measurement Range:
 - 80 to 200°C (-112 to 392°F)
- Probe Length: 2.36"
- Probe Wire Length: 39"



Model No.	Mfg. No.	Description	Price/Each
IC865	R2450SD-KIT6	Data Logging Thermometer	475.00

DIGITAL THERMOMETERS

- Temperature Range: -58 to 2000°F (-50 to 1300°C)
- User selectable °C or °F
- User selectable 0.1°F or 1°F (0.1°C or 1°C) resolution
- Accuracy to 0.5%
- Display maximum reading plus data hold
- Large LCD display with backlight
- Accept K-type thermocouples
- Includes: 9 V battery and holster



HX381

Model No.	Mfg. No.	Description	Price/Each
HX381	R2400	Single Input Thermocouple Thermometer	119.00

THERMOCOUPLE THERMOMETER KIT

- Type K thermocouple thermometer
- Large, easy-to-read backlit LCD display
- User selectable °C, °F or Kelvin
- Max and Data Hold functions
- Tripod mount for long-term monitoring
- Type: Contact
- Display Type: Digital
- Temperature Range: -58-2000°F (-50-1300°C)
- Accuracy: -58°F to 32°F: ±4°F, 32°F to 2000°F: ±(0.5% rdg+2°F), -50°C - 0°C: ±2°C, 0°C to 1000°C: ±(0.5% rdg+1°C), 1000°C to 1300°C: ±(0.8% rdg+1°C), 223K to 273K: ±5K, 273K to 2000K: ±(1.0% rdg+2K)
- Resolution: 0.1 or 1°F/°C, 1K
- Type: Single Input, Thermocouple Type K
- Includes: HX381 thermocouple thermometer, IB878 surface probe, IB880 air/gas probe, IB881 immersion probe, HK953 beaded wire probe and IB872 deluxe hard carrying case



Model No.	Mfg. No.	Description	Price/Each
IB877	R2400-KIT	Deluxe Thermometer Kit	529.00

THERMOCOUPLE THERMOMETER

- Displays up to 4 separate measurements simultaneously
- Accepts Type K, J, R, S, E, T thermocouple and RTD probes
- Temperature differential (T1-T2), Max/Min and Data hold functions
- Real-time data logger with integral SD memory card
- User selectable sampling rate from 1 to 3600 seconds
- Large, easy-to-read backlit LCD display
- Type: 4-Channel, Thermocouple, 2-Channel RTD
- Selectable Sampling Rate: Yes (1, 2, 5, 10, 30, 60, 120, 300, 600, 1800, 3600s)
- Power Supply: 6 x AA batteries or AC Adapter (optional)
- Operating Temperature: 32 to 104°F (0 to 40°C)



Model No.	Mfg. No.	Description	Price/Each
IC498	R2450SD	Thermocouple Meter	399.00
IC499	R2450SD-RTD	RTD Probe	219.00
IC494	RSD-ADP-NA	Power Adapter	39.00
IC495	RSD-16GB	16GB Memory Card	19.00

RTD THERMOMETERS

- Platinum resistor temperature sensor requires less temperature compensation than thermocouple units
- Selectable sensor types: Pt-100, Pt-500, Pt-1000 (4 wires)
- 4-digit LCD readout with LED backlight
- Min/Max/Avg functions
- Relative mode and data hold
- Low battery indication with auto power off
- Includes piercing type temperature probe
- Accredited calibration available

Temperature Range: -148 to 572°F (-100 to 300°C)
 Resolution: 0.1°F (0.1°C)
 Accuracy: ±0.1% reading +0.8°F (+0.4)
 Temp. Coefficient: <18°C & >28°C: 0.01% reading +0.03°C
 Power Supply: 3 x 1.5 V AAA alkaline batteries
 Battery Life: Approx. 100 hours
 Dimensions: 150 x 66 x 31 mm
 Weight: 175 g



Model No.	Mfg. No.	Description	Price/Each
IA421	C-370	RTD Thermometer	289.00
IA663	TP-R01	Pt-100 Temperature Probe	109.00
HN416	CA-05A	Soft Carrying Case	32.00

THERMOMETERS

VARIABLE ANGLE INDUSTRIAL THERMOMETERS

- V-shape case, molded of GE Valox® polyester, is 9" in length. Heavy glass protected front firmly secured against rattles by spring action
- For 3-1/2" stems only and ranges up to and including 300°F, the stem material is a precision die cast Zamac alloy
- Adjustable case locknut and angle adjusting screw work independently to provide a full 360° positioning of thermometer case and stem
- Adjustable joint completely encloses capillary to prevent tampering and foreign matter for entering instrument
- Tube and capillary are blue spirit filled-magnifying lens "blue reading" tube. Precision made to guarantee accuracy within 1% of scale range. Silicone shock mounted for lasting durability.
- Scale is locked in place and adjusted through top of scale

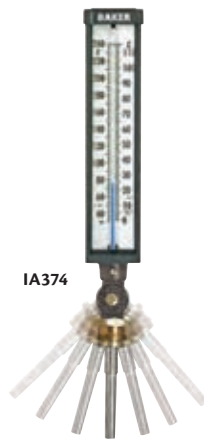

IA374

BAKER INSTRUMENTS

Model No.	Mfg. No.	Description	Price/Each
IA370	9VU35-115	Industrial Thermometer, -40 to 110 °F/-40 to 93 °C	69.00
IA371	9VU35-125	Industrial Thermometer, 0 to 120 °F/-17 to 49 °C	69.00
IA372	9VU35-165	Industrial Thermometer, 0 to 160 °F/-17 to 71 °C	69.00
IA374	9VU35-245	Industrial Thermometer, -40 to 240 °F/0 to 114 °C	69.00
IA375	9VU35-305	Industrial Thermometer, 30 to 300 °F/0 to 149 °C	69.00

STEM THERMOMETERS

- Large, easy-to-read LCD
- Fahrenheit/Celsius switchable
- Range: -40° to 450°F (-40° to 230°C)
- Accuracy: 0° to 230°F: ± 1.0°F; < 0°F: ± 3.6°F; > 230°F: ± 3.6°F
- Resolution: 0.1°F/°C
- 5" stainless steel stem
- Includes one 1.5 V LR44 button battery and protective probe cover



REED

Model No.	Mfg. No.	Description	Price/Each
IA728	R2000	Digital Stem Thermometer	27.00

STEM THERMOMETERS

- Easy-to-read LCD numerals
- Fahrenheit/Celsius switchable
- Range: -40° to 302°F (-40° to 150°C)
- Accuracy: ± 2°F or ± 1°C
- 5" stainless steel stem
- Immerse stem at least 1" for accurate readings
- Includes one 1.5 V LR44 button battery and protective probe cover



BIOS Professional

Model No.	Mfg. No.	Description	Price/Each
HX502	DT130	Digital Stem Thermometer	24.15

SURFACE THERMOMETERS

- Specifically designed to be used on horizontal or ferrous non-horizontal surfaces
- Two alnico magnets that act as the thermometer's base and hold it in place on ferrous surfaces
- Bimetallic sensor is a specially processed alloy that is preconditioned and pretested for permanent calibration and maximum stability
- Sensor is located in a draft shield and is in virtual thermal contact with the surface to be measured
- Sensing equilibrium (stability) is reached within three minutes and is accurate to ± 2% of full scale



HB592

BAKER INSTRUMENTS

Model No.	Mfg. No.	Temperature Range	Divisions	Price/Each
HB592	312FC	0° to 250 °F/-20° to 120 °C	2 °F/1 °C	29.00
HB598	314FC	50° to 750 °F/10° to 400 °C	10 °F/5 °C	29.00

BI-METAL THERMOMETERS

- All welded stainless steel construction
- Easy external recalibration adjustment
- 3" diameter anti-parallax dial
- Hermetically sealed per ASME B40.3
- Accurate to 1% per ASME B40.3 Grade A
- Over-range protection is 50% up to 500°F
- 1/2" NPT straight connection



IA266

BAKER INSTRUMENTS

Model No.	Mfg. No.	Description	Price/Each
IA266	T30025-250	0 to 250 °F/-20 to 120 °C, 2-1/2" stem	35.00
IA268	T3004-250	0 to 250 °F/-20 to 120 °C, 4" stem	35.00
IA270	T3006-250	0 to 250 °F/-20 to 120 °C, 6" stem	35.00
IA272	T3009-250	0 to 250 °F/-20 to 120 °C, 9" stem	35.00
IA267	T30025-550	50 to 550 °F/0 to 260 °C, 2-1/2" stem	35.00
IA269	T3004-550	50 to 550 °F/0 to 260 °C, 4" stem	35.00
IA271	T3006-550	50 to 550 °F/0 to 260 °C, 6" stem	35.00

WATERPROOF DIGITAL STEM THERMOMETER

- Temperature Range: -40° to 450°F (-40° to 230°C)
- Accuracy: ± 0.5°C (± 1°F)
- Fahrenheit/Celsius selectable via push button
- Compact pen-style design
- Stainless steel stem
- On-site calibration possible
- Waterproof construction and maximum temperature memory make this thermometer ideal for verifying dishwasher temperatures
- Includes protective case



BIOS Professional

Model No.	Mfg. No.	Description	Price/Each
IA542	DT131	Digital Stem Thermometer	32.85

DIGITAL STEM THERMOMETER

- Stainless steel stem thermometer offers a quick response and laboratory accuracy
- Easy to read LCD display
- Fahrenheit/Celsius switchable
- Display updates every 2 seconds
- Max/Min memory records highest and lowest temperatures
- Data hold button lets you freeze a reading
- Auto power off
- Includes: R2222 Digital Stem Thermometer, 1.5 V LR44 Button Battery, Protective Probe Cover
- Resolution: 0.1°C / 0.1°F
- Accuracy: ± 1.5% of reading ± 2°
- Weight: 35g
- Temperature Range: -40-482°F (-40-250°C)



REED

Model No.	Mfg. No.	Description	Price/Each
IB747	R2222	Digital Stem Thermometer	26.00

PRE-PROGRAMMED THERMOMETERS/TIMERS

- Pre-programmed cooking temperatures for different meats and tastes
- Select taste setting: Rare to well done
- Displays preset and internal cooking temperatures
- Stainless steel probe with 1 m heat resistant wire
- °C / °F switchable
- Temperature Range: -10° to 200 °C (14° to 392 °F)
- Weight: 6.4 oz



BIOS
Professional

Model No.	Mfg. No.	Description	Price/Each
HX158	DT100	Thermometer/Timer	44.00

INDOOR/OUTDOOR WIRELESS THERMOMETER

- Displays transmitted readings from a remote sensor up to 30 meters / 100 feet away from the indoor monitor
- With multiple sensor capability, the indoor monitor can display temperature from up to 3 sensors
- Min / Max memory
- Temperature trend
- °C / °F switchable
- Hangs or stands
- Type: Non-Contact
- Display Type: Analogue
- Temperature Range: 31-158°F (-35-70°C)
- Manufacturer's Warranty: 2 Year



BIOS
Professional

Model No.	Mfg. No.	Description	Price/Each
IC678	315BC	Wireless Thermometer	25.99

INDOOR/OUTDOOR WIRED THERMOMETERS

- Indoor/outdoor temperature
- Min/max memory
- 3 m/9.8' wired sensor probe
- Time and date
- °C / °F switchable
- Large LCD display
- Temperature trend
- Time and alarm features
- Freeze alarm



BIOS
Weather

Model No.	Mfg. No.	Description	Price/Each
IA808	313BC	Indoor/Outdoor Wired Thermometer	11.99

INDOOR/OUTDOOR WIRELESS HUMIDEX THERMOMETERS

- Displays humidex and heat index
- Humidex and heat index is a combination of temperature and humidity into one number to reflect perceived temperature
- Heat stress index scale
- Indoor and outdoor temperature
- Outdoor humidity
- Min/max memory
- °C and °F switchable
- Wireless transmission range: 45 m/150'



BIOS
Weather

Model No.	Mfg. No.	Description	Price/Each
IA504	260BC	Wireless Humidex Thermometer	56.90

INDOOR/OUTDOOR WIRELESS THERMOMETERS

- Indoor and outdoor temperature
- Min/max memory
- °C and °F switchable
- Wireless transmission range: 30 m/100'



BIOS
Weather

Model No.	Mfg. No.	Description	Price/Each
IA506	263BC	Thermometer for Humidity & Temperature	24.99

INDOOR THERMOMETERS FOR HUMIDITY & TEMPERATURE

- Indoor temperature and relative humidity
- Min/max memory
- °C and °F switchable



BIOS
Weather

Model No.	Mfg. No.	Description	Price/Each
IA505	261BC	Indoor/Outdoor Wireless Thermometer	40.99

INDOOR HYGROMETERS WITH BIOS COMFORT SCALE

- BIOS comfort scale indicates ideal humidity range for home and personal health
- Indoor temperature
- Min/max memory
- °C and °F switchable



BIOS
Weather

Model No.	Mfg. No.	Description	Price/Each
IA497	258BC	Indoor Hygrometer	31.99

INDOOR OUTDOOR THERMOMETERS W/CLOCK

- Displays indoor and outdoor temperatures and indoor relative humidity
- Multiple remote sensor capability
- Humidity range: 20 to 95% RH
- Indoor temperature range: 0 to 50°C (32 to 122°F)
- Outdoor temperature range: -35 to 60°C (-31 to 140°F)
- Includes indoor monitor and remote temperature sensor
- Power supply: 2 x 1.5 V AA batteries for both monitor and sensor



BIOS
Weather

Model No.	Mfg. No.	Description	Price/Each
IA807	312BC	Indoor/Outdoor Thermometers w/Clock	35.99

ENVIRONMENTAL METERS

THERMO-HYGROMETERS

COMPACT THERMO-HYGROMETER WITH INTEGRAL PROBE FOR CONVENIENT ONE-HAND OPERATION

- Dual LCD readout shows ambient temperature and relative humidity
- User selectable °F/°C
- Min/Max memory for both functions
- Data hold and relative functions
- Auto power off
- Includes battery
- Humidity Range: 0 to 100% RH
- Temperature Range: -4 to 140°F (-20 to 60°C)

IA441



REED

Model No.	Mfg. No.	Description	Price/Each
IA441	R6001	Thermo-Hygrometer	179.00
IB914	R9933	Calibration Standard 33%	99.00
IB915	R9975	Calibration Standard 75%	99.00

THERMO-HYGROMETERS

- Dual LCD display shows ambient temperature and relative humidity
- Humidity Range: 10% to 95% RH
- Temperature Range: 0° to 50°C/32° to 122°F
- User selectable °C/°F
- Data Hold and Min/Max function for humidity
- Compact and lightweight
- Battery included

HX287



REED

Model No.	Mfg. No.	Description	Price/Each
HX287	LM-81HT	Thermometer-Hygrometer	109.00
HN413	CA-52 A	Soft Carrying Case	30.00

BLUETOOTH SMART SERIES THERMO-HYGROMETER

- A compact thermo-hygrometer that measures ambient temperature and relative humidity
- The instrument can be used either stand-alone or with the REED Smart Series App (available for download on Android and iOS)
- Bendable, 90° swivelling probe shaft enables easy access to ducts
- Magnetic backing allows instrument to be mounted to metallic surfaces
- Data Hold function
- Tripod mount for long-term monitoring
- User selectable °C, or °F
- When used with the Reed Smart Series App, it is a real-time data logger, provides a user-selectable sampling rate from 1 to 120 seconds
- When used with the Reed Smart Series App, Bluetooth 5.0 provides connectivity up to 246' (75 m) away
- Export data via Excel or PDF and create custom reports that can be emailed from a mobile device when using the Reed Smart Series app
- Humidity Range: 0% - 100% RH
- Temperature Range: -4° - 140° F (-20° - 60° C)
- Includes: (1) Thermo-Hygrometer, (4) AAA Batteries
- Probe Shaft Length: 3.7" (95 mm)
- Probe Diameter: 0.43" (11 mm)
- Display Size: 1.3" (34 mm)
- Certifications: CE, UKCA, FCC, IC ID

REED



Model No.	Mfg. No.	Description	Price/Each
IC892	R1610	Thermo-Hygrometer	159.00
IC893	R1610-NIST	Thermo-Hygrometer with ISO Certificate	464.00

DATA LOGGING THERMO-HYGROMETERS

- Measures relative humidity as well as temperature with a type J/type K thermocouple thermometer
- Also measures dew point and wet bulb temperatures
- Data hold and Max/Min record
- Real time data logger with integral 4 GB SD memory card (optional)
- Temperature is measured in °C or °F

SPECIFICATIONS:

- **Humidity Range:** 5% to 95% RH
- **Type J Temp. Range:** -100° to 1200 °C
- **Type K Temp. Range:** -100° to 1300 °C

IC500



REED

Model No.	Mfg. No.	Description	Price/Each
IC500	R6050SD	Thermometer/Hygrometer	379.00
IC501	R6050SD-PROBE	Replacement Probe	139.00
IC494	RSD-ADP-NA	Power Adapter	39.00
IC495	RSD-16GB	16GB Memory Card	19.00

TEMP/RH DATA LOGGERS

MONITORS BOTH AMBIENT TEMPERATURE & RELATIVE HUMIDITY

- Stores up to 16 000 temperature and 16 000 humidity readings
- User selectable measurement rate from 2 seconds to 24 hours
- Alarm display if user-defined max/min values are exceeded
- Displays all status information through two LEDs
- Simply plug the logger into the USB port of your computer to begin downloading - no cables or wires are required
- Includes wall mount bracket and Windows® compatible software
- Temperature Range: -40 to 70°C (-40 to 158°F)
- Humidity Range: 0 to 100% RH

IA449



REED

Model No.	Mfg. No.	Description	Price/Each
IA449	R6020	Temperature/Humidity Data Logger	109.00
NJW176	R6020-NIST	Temperature/Humidity Data Logger with ISO Certificate	414.00

COMPACT TEMPERATURE & HUMIDITY METER

- Measures ambient temperature and relative humidity
- Designed for one-handed operation
- Backlit dual LCD display
- User selectable °F/°C
- Max, min and data hold functions
- Low battery indicator and auto shut off
- Humidity Range: 0% - 100% RH
- Temperature Range: 14° - 140° F (-10° - 60° C)
- Resolution: 0.1% RH
- Power Supply: 3 "AAA" Batteries

REED

Model No.	Mfg. No.	Description	Price/Each
IB974	R1910	Temperature/Humidity Data Logger	99.00



WET-BULB GLOBE TEMPERATURE (WBGT) HEAT STRESS METERS

- Measures ambient temperature, humidity, wet bulb temperature, black globe temperature, WBGT (wet bulb global temperature), heat stress index, dew point and pressure
- Heat Stress Index measures how hot it feels when humidity is combined with temperature, air movement and radiant heat
- Black Globe Temperature (GT) monitors the effects of direct solar radiation on an exposed surface
- In/Out function displays the WBGT value with or without direct sun exposure
- Internal memory stores up to 99 measurements
- User selectable unit of measure (°F or °C)
- User-adjustable WBGT threshold alarm (audible)
- Tripod mountable for long-term monitoring
- Air Temperature Range: 0 to 50°C (32 to 122°F)
- WBGT Temperature Range: 15° - 59°C (59° - 138.2°F)
- Humidity Range: 0% - 99.9% RH
- Power Supply: 4 x AAA Batteries, Optional AC Adapter



IB908

DATA LOGGING HEAT STRESS METERS

- Measures temperature, humidity, dew point, wet bulb, black globe, indoor/outdoor WBGT
- Wet Bulb Globe Temperature (WBGT) considers the effects of temperature, humidity and direct or radiant sunlight
- Real-time data logger with integral SD memory card
- Temperature is measured in °C or °F
- Adjustable audible alarm
- Data hold and min/max functions
- User selectable sampling rate from 1 to 3600 seconds
- Tripod mount for long-term monitoring
- Indoor WBGT Range: 0° - 59°C (32° - 138°F)
- Outdoor WBGT Range: 0° - 56°C (32° - 132°F)
- TG Temperature Range: 0° - 80°C (32° - 176°F)



REED

Model No.	Mfg. No.	Description	Price/Each
IB908	R6200	Heat Stress Meter	219.00
HN416	CA-05A	Carrying Case	32.00
IB820	R1500	Tripod	109.00
IB914	R9933	33% Humidity Calibration Standard	99.00
IB915	R9975	75% Humidity Calibration Standard	99.00

REED

Model No.	Mfg. No.	Description	Price/Each
IC502	R6250D	Heat Stress Meter	539.00
IC495	RSD-16GB	16GB Memory Card	19.00
IC494	RSD-ADP-NA	Power Adapter	39.00

PSYCHROMETERS

- Simultaneous display with % RH, temperature and dew point or wet bulb or external probe temperature (requires IA108)
- Calculates T1-T2 (Air temp. - External probe temp.) (requires IA108)
- Triple display with backlighting
- Max/Min readings
- Sensor cap closes to protect probe during storage
- Retrieve Max/Min/Avg readings from stored data
- Real time clock



IA000

SPECIFICATIONS:

Humidity Range:	0 to 100% RH
Dew Point Range:	-90° to 122°F (-68° to 50°C)
Wet Bulb Range:	-5° to 122°F (-21° to 50°C)
Internal Temp. Range:	-4° to 122°F (-20° to 50°C)
External Temp. Range:	-4° to 158°F (-20° to 70°C)

REED

Model No.	Mfg. No.	Description	Price/Each
IA000	8706	Digital Psychrometer	139.00
IA108	87P6	Temperature Probe	30.00
IB914	R9933	33% Humidity Calibration Standard	99.00
IB915	R9975	75% Humidity Calibration Standard	99.00

TEMP/RH DATA LOGGERS

- Records up to 32 700 ambient temperature and relative humidity readings
- User selectable recording intervals from 1 s to 24 h
- Minimum/Maximum function with alarm
- Real-time clock stores data and time
- LCD readout displays current temperature (°F or °C) or humidity reading, min/max reading with date and time
- Download data directly to a PC via USB cable supplied
- Includes data logger, mounting bracket with screws, USB cable, software diskette, security lock and battery
- Temperature Range: -40 to 70°C (-40 to 158°F)
- Humidity Range: 0 to 100% RH



REED

Model No.	Mfg. No.	Description	Price/Each
IA680	R6030	Temperature/RH Data Logger	179.00

HEAT STRESS STOP WATCHES

- Measures temperature and humidity, and calculates heat index as well as dew point
- Combines air temperature and relative humidity measurements in an attempt to determine the human-perceived equivalent temperature or "how hot it feels"
- Calendar mode displays day, date and time
- Stopwatch/chronograph mode with 1/100 second resolution
- Fastest/Slowest/Average Lap recall
- 99 lap counter with 30 lap/split memory
- 10 hour countdown timer with audible beeper warning for the last 5 seconds
- 12 or 24 hour clock operation
- Full LCD display with LED backlight
- Silent operation option
- Dual power: solar panel and battery
- 1 ATM water resistant (IPX4 rated)

SPECIFICATIONS:

Timing Capacity:	9 hrs, 59 mins, and 59 secs
Accuracy:	±3 seconds/day
Lap Memory:	30 laps
Heat Index Range:	70 to 122°F (22 to 50°C)
Temperature Range:	23 to 122°F (-5 to 50°C)
Humidity Range:	1 to 99% RH
Dimensions:	2.65 x 3.6 x 0.9" (67.5 x 92 x 23 mm)
Weight:	2.93 oz (83 g)



REED

Model No.	Mfg. No.	Description	Price/Each
IA987	SW700	Heat Index Stop Watch	59.00



DATA LOGGING INDOOR AIR QUALITY METER WITH HUMIDITY CALIBRATION STANDARDS

- Includes: R9905 Data Logging Indoor Air Quality Meter, R9933 33% Humidity Calibration Standard, R9975 75% Humidity Calibration Standard
- Measures carbon dioxide (CO₂), temperature, humidity and automatically calculates time-weighted average (TWA) and short-term exposure Limit (STEL)
- CO₂ Range: 0 - 30000 ppm
- Temperature Range: -4° - 140° F (-20° - 60° C)
- Humidity Range: 0% - 100% RH



REED

Model No.	Mfg. No.	Description	Price/Each
IC861	R9905-KIT	Indoor Air Quality Meter	759.00

INDOOR AIR QUALITY METER WITH DESKTOP/WALL MOUNT

- Measures and records carbon dioxide (CO₂), temperature, and humidity
- Features a high-resolution color TFT touchscreen display, user-selectable recording times, programmable alarm set points, a built-in desk stand, and a wall mounting bracket
- Quickly generate an Excel file with raw data and export recorded data to a computer without the use of the software
- Low-drift NDIR CO₂ sensor for stable and accurate readings
- Max/min display
- Internal 16GB memory stores data points in CSV format
- User selectable sampling rate from 1 second to 24 hours
- Internal time and date stamp
- Rechargeable li-ion battery
- Low battery indicator
- Includes: Indoor air quality meter, USB cable, Power Adapter, Wall mounting bracket
- CO₂ Range: 0 - 9999 ppm
- Temperature Range: 32° - 122° F (0° - 50° C)
- Humidity Range: 0% - 100% RH
- Manufacturer's Warranty: 1 Year



REED

Model No.	Mfg. No.	Description	Price/Each
IC868	R9920	Indoor Air Quality Meter	1195.00
IC869	R9920-NIST	Indoor Air Quality Meter with ISO Certificate	1500.00

REFRACTOMETER

- This 0 to 55% Brix digital handheld refractometer measures the concentration percentage in almost any juice, drink, or food, such as soup, sauce, or jams
- Features a fast three-second response time and a dual LCD, which simultaneously shows % Brix and temperature
- Ergonomically designed for one-handed operation
- Features built-in ATC (Automatic Temperature Compensation), single Zero calibration, a prism cover, rechargeable Li-ion battery, and an IP54-rated housing
- Sapphire prism with abrasion and corrosion-resistant coating
- Includes: Digital refractometer, USB cable, Cleaning cloth, Solution/sample applicator
- Temperature Range: 50 to 104°F (10 to 40°C)



REED

Model No.	Mfg. No.	BRIX Range	BRIX Resolution	Price/Each
IC867	R9510	0 - 55 %	0.1 %	329.00

CONDUCTIVITY/TDS/SALINITY METERS

- Displays both temperature and conductivity, total dissolved solids (TDS), or salt levels simultaneously on a dual LCD display
- Automatic Temperature Compensation (ATC)
- Data hold and Min/Max functions
- User selectable °F or °C
- Waterproof housing meets IP57 standard
- Replaceable electrode module
- Low battery indicator and auto shut off
- (4) AAA batteries power supply
- CE & IP57 certified
- Measurement Range: 0 - 2000 µS, 2 mS/cm - 20 mS/cm
- Salinity Measuring Range: 0 to 1000ppm, 1 to 12ppt
- Total Dissolved Solids (TDS) Measuring Range: 0 to 1300ppm, 1.30 to 13ppt
- Temperature Measuring Range: 32 to 194°F (0 to 90°C)
- Manufacturer's Warranty: 1 Year
- Includes: (1) R3530 Conductivity/TDS/Salinity Meter, (4) Batteries, (1) Hard Carrying Case, (1) Allen Key, (2) Replacement Screws, (1) Lanyard



IC873

REED

Model No.	Mfg. No.	Description	Price/Each
IC873	R3530	Conductivity/TDS/Salinity Meter	179.00
IC874	R3530-NIST	Conductivity/TDS/Salinity Meter with ISO Certificate	409.00
IC879	R3530-KIT	Conductivity/TDS/Salinity Meter with Solution	189.00

PH/MV METERS WITH TEMPERATURE

- Measures pH and mV levels in liquids
- Microprocessor provides automatic buffer solution recognition
- Dual LCD displays pH or mV and temperature simultaneously
- Automatic Temperature Compensation (ATC)
- Designed for handheld or wall mount applications
- User selectable °F or °C
- Replaceable electrode module
- Low battery indicator and auto shut off
- 9 V battery or optional AC adapter power supply
- CE certified
- pH Range: 0 - 14 pH
- Operating Temperature: 32 to 122°F (0 to 50°C)
- Includes: pH/mV Meter, pH Electrode, protective holster, 4 and 7pH Buffer Solution, mounting suction cup, battery
- Manufacturer's Warranty: 1 Year



IC871

REED

Model No.	Mfg. No.	Description	Price/Each
IC871	R3525	pH/mV Meter	239.00
IC872	R3525-NIST	pH/mV Meter & ISO Certificate	469.00
IC875	R3525-KIT	pH/mV Meter with Buffer Solution	265.00
IC876	R3525-KIT2	pH/mV Meter with Buffer Solution & Power Adapter	299.00

REFRACTOMETERS

BRIX REFRACTOMETERS

The Brix refractometer shows the concentration percentage of the soluble solids content (Total solids) of a sample (water solution). The soluble solids content is the total of all the solids dissolved in the water - beginning with sugar, salts, protein, acids, etc. and the measurement reading value is the value of the sum total of those. Essentially Brix% is calibrated to the number of grams of cane sugar contained in 100 g of cane sugar solution. So, when measuring a sugar solution, the Brix% should perfectly match the actual concentration.



HX107

REED

Model No.	Mfg. No.	BRIX Range	Min. Div.	Accuracy	Price/Each
HX107	R9500	0 - 32%	0.2%	±0.2%	139.00

SALINITY REFRACTOMETERS

Salinity refractometers are useful for measuring the concentration of natural or artificial seawater in aquariums, holding tanks, and breeding ponds. They can also be used for controlling the salt water concentration when preparing pickles, measuring the concentration of salt water used in rinsing and cooking sea products.



HK668

REED

Model No.	Mfg. No.	Range	Min. Div.	Accuracy	Price/Each
HK668	R9600	0 - 28%	0.2%	±0.2%	139.00

BATTERY COOLANT CHECKERS

It is essential to know the concentration and freezing point of anti-freeze coolants for vehicular safety. Keeping a suitable concentration of coolant prevents engine trouble and possible radiator corrosion. This tester monitors the freezing point of both ethylene glycol and propylene glycol; in addition, it indicates battery recharge level. This tester is simple to use; requiring only a few drops to provide accurate readings within seconds. It is virtually indispensable for gas stations, service shops, cab companies, etc.



HX093

REED

Model No.	Mfg. No.	Coolant	Range	Min. Div.	Price/Each
HX093	R9700	Propylene Glycol	-50 to 32°F	10°F	139.00
		Ethylene Glycol	-50 to 32°F	10°F	

PH PEN METERS

- Displays both temperature and pH simultaneously on a dual LCD display
- Features automatic temperature compensation for accurate readings and includes a built-in calibration procedure
- User selectable °F or °C
- Data hold function
- Waterproof housing
- Protective cap keeps sensor moistened
- Low battery indicator and auto shut off
- pH Range: 0 - 14 pH
- Temperature Measuring Range: 32 - 140°F (0 - 60°C)
- Temperature Accuracy: ±1.8°F (1°C)
- Temperature Resolution: 0.1°F (0.1°C)
- pH Accuracy: ±0.02 pH
- Resolution: 0.01 pH
- Includes: (1) pH Meter, (1) Replaceable pH electrode module, (1) Protective cap, (1) Hard carrying case, (4) LR44 Batteries



IC483



IC481

REED

Model No.	Mfg. No.	Description	Price/Each
IC481	R3500	pH Pen Meter	119.00
IC482	R3500-NIST	pH Pen Meter with ISO Certificate	349.00
IC483	R3500-Electrode	pH Electrode	49.00

PH BUFFERS & SOLUTIONS

- Ready to use solutions
- Made with high quality materials to provide high consistency



IC579

REED

Model No.	Mfg. No.	Description	Price/Each
IC579	R1404	4.01 pH Buffer Solution 500 ml	20.00
IC580	R1407	7.00 pH Buffer Solution 500 ml	20.00
IC581	R1410	10.00 pH Buffer Solution 500 ml	20.00
IC608	R1400-KIT	1 each of IC579, IC580 and IC581	57.00
IC582	R1420	Electrode Storage Solution 500 ml	20.00
IC583	R1425	Electrode Cleaning Solution 500 ml	20.00
IC584	R1430	Standard Conductivity Test Solution 500 ml	20.00

PH/MV METER WITH TEMPERATURE

- Measures pH and mV levels in liquids
- Microprocessor provides automatic buffer solution recognition
- Dual LCD displays pH or mV and temperature simultaneously
- Automatic Temperature Compensation (ATC)
- Designed for handheld or wall mount applications
- User selectable °F or °C
- Replaceable electrode module
- Low battery indicator and auto shut off
- 9V battery or optional AC adapter power supply
- CE certified
- pH Range: 0 - 14 pH
- pH Accuracy: ±(0.01pH +1 dgt.), ±(2mV +1 dgt.)
- pH Resolution: 0.01pH, 0.1/1mV
- Temperature Accuracy: ±0.4°F (0.2°C) +1 dgt.
- Temperature Resolution: 0.1°F (0.1°C)
- Includes: pH/mV Meter, pH Electrode, protective holster, 4 and 7pH Buffer Solution, mounting suction cup, battery



REED

Model No.	Mfg. No.	Description	Price/Each
IC871	R3525	pH/mV Meter w/Temperature	239.00
IC872	R3525-NIST	pH/mV Meter w/Temperature with ISO Certificate	469.00

THICKNESS, COATING & HARDNESS METERS

ULTRASONIC THICKNESS GAUGE

- Able to gauge thickness measurement without requiring access to both sides of the test piece
- Determines sample thickness by measuring the amount of time it takes for sound to traverse from the transducer through the material to the back end of a part and back
- Calculates the data based on the speed of the sound through the tested sample
- Capable of performing measurements on a wide range of material including metals, plastic, ceramics, composites, epoxies, glass, and other ultrasonic conductive materials
- Zero function and sound velocity calibration
- Two-point calibration • Display: Digital
- Coupling status indicator • Measuring Mode: Ultrasound
- Can be easily deployed, does not require laboratory conditions
- Thickness Range: 0.03" - 15.7" (0.65 mm - 400.0 mm)
- Sound Velocity Range: 1000 to 9999 m/s (0.039 to 0.394 in/μs)
- Measurement Speed: 4 per second for a single point measurement
- Memory: 5 files, up to 100 values for each file (total of 500 logs)
- Power Supply: 2 x 1.5V AA batteries • Frequency: 5MHz
- Measurement Range: 1.2 to 300.0mm (steel)
- Includes ultrasonic couplant gel, probe, hard carrying case and batteries

REED



IB827

Model No.	Mfg. No.	Description	Price/Each
IB827	R7900	Ultrasonic Thickness Gauge	1095.00
IB887	R7900-Probe	Replacement Probe	255.00

THICKNESS GAUGES

- Exclusive micro-computer LSI circuit and crystal time base offer high accuracy
- Digital display provides exact readings without guessing or errors
- Broad band receiving sensitivity means the meter can read probes of different frequencies
- Auto calibration
- Automatic material calibration
- Selectable metric or imperial
- Measures the thickness of steel, cast iron, aluminum, red copper, zinc, quartz glass, polyethylene, PVC, gray cast iron and nodular cast iron
- Display sound velocity at the touch of a button
- Measuring range: 1.5 to 200 mm in #45 steel
- Velocity range: 500 to 9000 m/s



REED

Model No.	Mfg. No.	Description	Price/Each
HX399	TM-8811	Ultrasonic Thickness Gauge	459.00
IA746	TM-8811probe	Replacement Probe	195.00

GLOSS METER

- Compact design allows for one-handed operation
- Multi-angle measurement (20/ 60/ 85°)
- Backlit LCD display
- Auto calibration
- Internal memory stores last 254 data points
- Built-in rechargeable battery
- Designed to meet ASTM D523, ASTM D1455, ASTM C584 and ASTM D2457 international standards
- Includes: R7700 Gloss Meter, AC Adapter, Calibration Standard, Cleaning Cloth and Hard Carrying Case
- Range: 0.1 - 200 GU



REED

Model No.	Mfg. No.	Description	Price/Each
IB910	R7700	Gloss Meter	895.00

DUROMETERS

- Digital durometer for Shore A hardness testing
- Designed to measure the penetration hardness of rubber, elastomer and other rubber like substances such as neoprene, silicone and vinyl
- Pocket-sized model with integrated probe
- Measures maximum value
- Calculates average value
- Push button zero calibration
- Bright, clear, 4-digit, 10 mm high LCD readout
- Meets DIN 53505, ASTM D2240, ISO 7619 and JISK 7215



SPECIFICATIONS:

- Measuring range:** 0 to 90 HA
- Resolution:** 0.1 HA
- Deviation:** ± 1 HA

REED

Model No.	Mfg. No.	Description	Price/Each
IA632	HT-6510A	"A" Scale Durometer	495.00

R9030 HARDNESS TESTERS

- Rebound hardness testing is particularly useful for large, coarse grained materials, forged parts and all types of cast materials
- Measures the velocity of a propelled impact body directly before and after the impact onto the test material's surface
- Capable of automatically converting and displaying measurements into Rockwell (HRC, HRB, HRA), Brinell (HB), Leeb (HL), Vickers (HV) and Shore (HS) hardness values
- Materials that can typically be tested include cast steel, alloy tool steel, stainless steel, aluminum, bronze, copper, cast irons, etc.
- Conversion of measurements to tensile strength (U.T.S.)
- Large capacity memory can store up to 350 groups of information (depending upon impact times) including measurement value, mean value, testing date, impact direction, impact times, material and hardness scale
- Mini USB data interface
- Operates on a rechargeable lithium battery
- 128 x 32 dot matrix LCD with battery life display
- Includes: R9030 Hardness Tester, D Impact Device, Small Supporting Ring, Leeb Test Block, Nylon Brush, Battery Charger, Data Processing Software, Communication Cable
- Hardness Scale: HL, HRC, HRB, HRA, HV, HB, HS
- Measuring Range: HLD: 170 to 96, HRA: 59 to 85m, HRB: 13 to 100, HRC: 20 to 68, HB: 19 to 651, HV: 80 to 967, HS: 30 to 100



REED

Model No.	Mfg. No.	Description	Price/Each
IB748	R9030	Hardness Tester	1995.00

STEEL HARDNESS TESTERS

- Designed for accurate, rapid in place measurement of the hardness of steel and steel alloys in the range from 20 to 65 on the equivalent Rockwell C Scale
- Unit consists of two major components: calibrated indenter and direct reading microscope
- Hand-held impact indenter drives a 1/16" diameter tungsten carbide ball into the sample being tested
- Resulting indentation diameter is measured with 60X microscope
- Calibrated reticle in the microscope reads C Scale directly with an accuracy of ± 1.5 points
- Illumination system features a MagLite® flashlight with a fiber optic pipe that directs the light to the focus of the microscope
- Flat or curved surfaces of virtually any configuration may be measured
- Particularly useful where the test piece is too large or too heavy to test on bench-type tester



PTG
INSTRUMENTS

Model No.	Mfg. No.	Description	Price/Each
HB605	316	Steel Hardness Tester	2070.25

SOUND LEVEL METERS

- Dual range measurement (Hi/Low)
- A and C frequency weighting
- Large, easy-to-read LCD display
- Electret condenser microphone for high accuracy and longterm stability
- AC/DC output signal for use with dataloggers
- Data Hold, Max Hold functions and low battery indication
- Meets IEC651 Type 2 requirements
- Measuring range: Low: 35 to 100 dB; High: 65 to 135 dB (A and C)
- Operating Temperature: 32 to 104°F (0 to 40°C)
- Operating Humidity: 10-90%
- Includes carrying case and battery



IB831

REED

Model No.	Mfg. No.	Description	Price/Each
HX387	R8050	Sound Level Meter	195.00
IB831	R8050-KIT	Sound Level Meter and Calibrator Kit	529.00
IB820	R1500	Tripod with Instrument Adapter	109.00

LIGHT METER

- Capable of measuring in both Footcandle (Fc) and Lux
- Wide measuring range
- Easy-to-read backlit LCD display
- 42-segment Digital analog bargraph
- Min/Max and Relative Mode functions
- Peak and data hold functions
- Low battery indicator and auto shut off
- The tethered sensor allows for flexible operation while taking measurements
- Includes: Light meter, Sensor cover, Protective holster, Carrying case, Battery
- Measuring Range: 0-400000 lux (0-40000 ftc)
- Data Logging /Non-Data Logging: Non-Data Logging
- Accuracy: $\pm(5\% \text{ rdg.} + 0.5\% \text{ Full Scale})$
- Repeatability: $\pm 3\%$
- Max. Resolution: 0.01 Lux/Fc
- Response Time: 13.3 Times/Second (Bargraph), 1.3 Times/Second (Numeric Display)
- Sensor Type: Photo Diode with Spectral Response Filter
- Spectral Response: CIE Photopic (CIE Human Response Curve)
- Operating Temperature: 32°F - 104°F (0°C - 40°C)
- Storage Temperature: 14°F - 140°F (-10°C - 50°C)
- Operating Humidity Range: 10 - 80%



IC655

REED

Model No.	Mfg. No.	Description	Price/Each
IC655	R8130	Light Meter	175.00
IC656	R8130-NIST	Light Meter with ISO Certificate	480.00

LED LIGHT METER

- Measures ambient light levels of white, red, yellow, green and blue LED light and visible light in Foot-candles or Lux
- Detachable and rotatable light sensor
- User adjustable parameter for specialized light sources
- Measuring Range: 0-199 lux
- Data Logging /Non-Data Logging: Data Logging
- Battery Life: 80 Hours
- Operating Temperature: 32 to 104°F (0 to 40°C)
- Power Supply: 2 x AA Batteries



REED

Model No.	Mfg. No.	Description	Price/Each
IB929	R8140	LED Light Meter	209.00
HN413	CA-52A	Carrying Cases	30.00

LIGHT METERS

- Designed for one-hand operation and to fit easily into a tool belt or pocket
- Autoranging
- Data Hold and Min/Max functions
- Auto shut-off and zero adjust button
- Over range and low battery indications
- Ranges: 0 to 20 000 lux; 0 to 2000 ftc
- User selectable Lux/Ftc
- Includes battery



REED

Model No.	Mfg. No.	Description	Price/Each
HX288	LM-81LX	Light Meter	109.00

LIGHT METERS

- Measures ambient light levels as well as temperature with a type J/type K thermocouple thermometer
- Sensor features two filters and meets C.I.E. spectrum Specifications:
- Real time data logger with integral SD memory card (optional)
- Light levels are measured in ftc or lux
- Temperature is measured in °C or °F
- Light range: 2000, 20 000, 100 000 lux
- Temp. range: J: -100° to 1200 °C; K: -100° to 1300 °C



REED

Model No.	Mfg. No.	Description	Price/Each
IC552	R8100SD	Light Meter	269.00
IC574	R8100SD-PROBE	Replacement Probe	109.00
IC494	RSD-ADP-NA	Power Adapter	39.00
IC495	RSD-16GB	16GB Memory Card	19.00

ENVIRONMENTAL METERS

- Measures relative humidity, air velocity, light levels, and temperature with a type J/type K thermocouple thermometer
- Real time data logger with integral SD memory card (optional)
- Air velocity is measured in m/s, ft/min, km/h, mph or knots
- Light levels are measured in ftc or lux
- Light range: 0 to 20 000 lux
- Humidity range: 5 % to 95 % RH
- Air velocity range: 0.4 to 25.0 m/s
- Temp. range: J: -50° to 1200 °C; K: -50° to 1300 °C



REED

Model No.	Mfg. No.	Description	Price/Each
IC551	R4700SD	Thermometer/Hygrometer	359.00
IC572	R4700SD-PROBE	Replacement Probe	179.00
IC494	RSD-ADP-NA	Power Adapter	39.00
IC495	RSD-16GB	16GB Memory Card	19.00

SPEED, DISTANCE & LENGTH MEASURERS

TACHOMETERS

- Dual function unit with both contact and non-contact capabilities
- Supplied with adapters for fpm, rpm and surface speed measurements
- Non-contact function utilizes laser light beam for improved accuracy
- Recalls Max/Min and last values
- Large, easy-to-read display
- Autoranging with 0.05% accuracy
- Includes battery and carrying case
- Measuring Range: Photo: 5 to 99,999 rpm; Contact: 5 to 19,999 rpm; Surface Speed: 0.05 to 1999 mpm



TACHOMETERS

- Patented design incorporates both a photo and a contact tachometer into one precision instrument
- Ranges: from 0.5 to 20 000 rpm in contact mode; from 5 to 99 999 rpm in photo mode; surface speed from 0.05 to 1999.9 mpm (0.2 to 6560 fpm)
- Linear surface speed measurements are 0.2 to 6560 fpm or 0.05 to 1999.9 mpm
- Automatically holds last reading for five minutes and recalls min. and max. readings
- Characters on the large 5-digit display reverse direction depending on which measurement mode you are in
- Provides accuracy to 0.05% and permits readings to a resolution of 0.1 rpm in either photo or contact mode



REED

Model No.	Mfg. No.	Description	Price/Each
HX386	R7100	Photo/Contact Tachometer	179.00
NJW178	R7100-NIST	Photo/Contact Tachometer w/ISO Certificate	349.00
IA046	ST-TIP	Replacement Contact Adapter	5.00
IA047	ST-WHEEL	Replacement Surface Speed Wheel	20.00
IA740	ST-FUNNEL	Replacement Funnel Tip	11.00
IA741	ST-SHAFT	Replacement Extension Shaft	13.00
IA986	RT100	Reflective Tape, 24" Strip	8.00

REED

Model No.	Mfg. No.	Description	Price/Each
HF964	R7140	Photo/Contact Tachometer	379.00
NJW106	R7140-NIST	Photo/Contact Tachometer w/ISO Certificate	549.00
IA046	ST-TIP	Replacement Contact Adapter	5.00
HF228	CONE	Replacement Cone Adapter	20.00
IA986	RT100	Reflective Tape, 24" Strip	8.00
HN416	CA-05A	Carrying Case	32.00

COMPACT PHOTO TACHOMETER

- Provides fast and accurate RPM measurements of rotating objects without contact and revolution count of moving objects
- Built-in laser pointer identifies target area
- Durable double molded plastic housing and large backlit LCD display
- Internal memory recalls maximum, minimum values as well as last value stored
- Low battery indicator and auto shut-off
- Visible Indicator: Yes (Laser)
- Target Distance: 1.6ft (500mm)
- Display Size/Type: 5 Digit LCD Display
- Auto shut-off: Yes (after 10 secs)
- Power Supply: 9V battery
- Product Certifications: CE
- Dimensions: 6-5/16" x 2-5/16" x 1-1/2"



PROFESSIONAL DUAL FUNCTION TACHOMETER

- Quick responding and accurate dual function tachometer with the ability to measure non-contact RPM with built-in laser and contact measurements in ft/min (m/min)
- Laser provides improved accuracy at a greater distance
- 5-Digit LCD display reverses depending on measurement mode
- RPM Range (Contact): 0.5 - 19,999
- RPM Range (Photo): 10 - 99,999
- Surface Speed Range: 0.05 - 1,999.9 m/min, 0.2 - 6,560 ft/min
- Photo Resolution: 0.1 RPM (=999.9) / 1 RPM (>1000)
- Contact Resolution: 0.1 RPM (=999.9) / 1 RPM (>1000)
- Surface Resolution: 0.01 m/min (=99.9) / 0.1 m/min (=100) / 0.01 ft/min (=999.9) / 1 ft/min (=1000)
- Photo Target Distance: 6.5' (2000 mm)
- Photo Sampling Time: 1 sec. (Over 60 RPM)
- Contact Sampling Time: 1 sec. (Over 6 RPM)
- Includes: (1) Combination contact/non-contact tachometer with laser, (1) Reflective tape, (1) Large cone tip adapter, (1) Small cone tip adapter, (1) Funnel adapter, (1) Wheel adapter, (4) AA batteries, (1) Hard carrying case



REED

Model No.	Mfg. No.	Description	Price/Each
IA419	R7050	Photo Tachometer	139.00
IC565	R7050-NIST	Photo Tachometer w/ISO Certificate	309.00
IA986	RT100	Reflective Tape, 24" Strip	8.00

Model No.	Mfg. No.	Description	Price/Each
HX273	R7150	Professional Dual Function Tachometer	439.00
NJW094	R7150-NIST	Professional Dual Function Tachometer w/ISO Certificate	609.00
HF228	CONE	Replacement Cone Adapter	20.00
IA986	RT100	Reflective Tape, 24" Strip	8.00
HD906	AS-35C	Replacement Measuring Wheel	19.00

DIGITAL STROBOSCOPE

- Simply aim the instrument at the rotational object and synchronize the strobe's flash rate (FPM) with object speed (FPM)
- 5 to 30 minute duty cycle (RPM dependent)
- Tripod mount for stationary use
- 6 foot power cord
- Voltage: 110 Vac
- Measuring Range: 100 - 10 000 rpm
- Resolution: 1 RPM
- Basic Accuracy: $\pm(0.05\% + 1 \text{ dgt.})$
- Type: Xenon lamp
- Flash Duration: Approx. 60 to 1000 μs
- Flash Colour: Xenon white 6500°K
- Product Certifications: CE
- Dimensions: 8-5/16" x 4-13/16" x 4-13/16"

Model No.	Mfg. No.	Description	Price/Each
HF965	K4020	Digital Stroboscope	295.00
NJW108	K4020-NIST	Digital Stroboscope w/ISO Certificate	465.00
IB742	R8888	Deluxe Carrying Case	89.00
IB820	R1500	Tripod with Instrument Adapter	109.00
HF966	K4020-BULB	Replacement Xenon Bulb	50.00



REED

LASER DISTANCE METERS

- Designed for one handed operation
- User selectable unit of measure (imperial/metric)
- Laser target pointer
- Reference point selection (front or rear of instrument)
- Quick, self calculation with real-time readout
- Backlit multi-line LCD display
- Area, Volume and Max/Min functions
- Addition, Subtraction and indirect 2/3 point (Pythagoras) calculations

- Integrated bubble level (horizontal and vertical)
- Continuous measurement mode
- Internal memory saves up to 99 readings
- Measuring Range: 0' - 164' (0 m - 50 m)
- Accuracy: $\pm(2.0\text{mm}+d \times 0.005\%)$
- Measuring Units: m, ft, in, ft + in
- Certification(s): CE, RoHS



IC857

REED

Model No.	Mfg. No.	Description	Price/Each
IC857	R8005	Laser Distance Meter	79.00
IC858	R8005-NIST	Laser Distance Meter w/ISO Certificate	369.00

STOP WATCHES

MODEL IA078

- High contrast digital display with backlight
- Clock, date and alarm functions
- Records real time and split times
- Remembers first 30 laps and their split times (max. 99 laps displayed)
- 1/100th second resolution up to 100 hours
- Shock and water-resistant case



IA078

MODEL IA006

- Large LCD that displays real time and records split times for accurate result
- Clock, date and alarm function
- Water-resistant
- Includes: Batteries and a 48" nylon lanyard which allows you to comfortably hang the stopwatch around your neck



IA006

BIOS
Fitness

Model No.	Mfg. No.	Description	Price/Each
IA078	FP603	Digital Stop Watch, w/neck lanyard and battery	36.99
IA006	FP600	Digital Stop Watch, w/neck lanyard and battery	12.99

DIGITAL DISTANCE MEASURING WHEEL

- Lightweight and easy to use, designed for professional and personal usage
- Large wheel model ensures accuracy and is ideal for uneven terrain
- Suitable for outdoor and indoor distance measuring applications
- Pistol grip handle for ergonomic comfort
- Backlight for low light conditions
- Metric and imperial measurement with 5 memory storage entries
- Accuracy of $\pm 0.5\%$
- Telescopic handle
- Push button reset
- Adds forward, subtracts in reverse
- Equipped with a sturdy flip-down kickstand and carrying bag for easy storage and portability
- Measuring Range: 99999.9 m
- Graduations: Feet/Metres
- Wheel Diameter: 12.5"/31.8 cm
- Resolution: 0.1 m
- Power: 3 V (2xLR3 Batteries)
- Suitable Temperature: -10°C - 45°C



AURORA
TOOLS

Model No.	Description	Price/Each
TTY302	Digital Distance Measuring Wheel	109.00

TALLY COUNTERS

MODEL HD317 HAND TALLY COUNTERS

- Sturdy 4-figure hand-operated reset counter
- Push button actuator and handy thumb ring for easy operation
- Chrome plated steel case resists damage from perspiration
- Recommended for applications where operator must be mobile, such as checking meeting attendance, taking warehouse inventories, etc.



HD317

MODEL HD339 STAND TALLY COUNTERS

- Sturdy 4-figure hand-operated reset counter
- Special mounting base designed for desk, bench or clipboard mounting
- Heavy gauge steel case and base are chrome plated to resist corrosion
- Recommended for fixed applications such as assembly line parts counting, traffic surveys, etc.



HD339

BAKER
INSTRUMENTS

Model No.	Mfg. No.	Description	Price/Each
HD317	7655	Hand Tally Counter	16.00
HD339	8-005-1	Stand Tally Counter	19.00

PLASTIC RATCHET COUNTERS

- Reliable, low cost, plastic counters for all purposes
- Operated by stroke (ratchet) drive
- Counts with one 45° adjustable lever movement (spindle on right side)
- 5-figure register with knob reset
- Supplied with connecting spring
- 5-figure reset counter counts machine revolution
- Adds when lever is revolved counter clockwise (spindle on right side)



BAKER
INSTRUMENTS

Model No.	Mfg. No.	Description	Price/Each
HA931	2012-5	Right Ratchet Counter, Plastic	19.00

VIBRATION, FORCE GAUGES & LENGTH MEASURERS

ELECTROMAGNETIC FIELD METERS

- AC & DC magnetic field measurement
- Measurements Range: ± 3000 milliGauss
- Measurements in milliGauss or μT (microTesla)
- Detects magnetic fields as small as 0.1 milliGauss
- N pole/S pole indicator
- Zero adjustment button for relative measurement
- Data hold and max./min. record
- Easy to read LCD with backlight
- Auto or manual power off
- RS232 and USB interface

Model No. IA806
Mfg. No. GU-3001
Price/Each \$595.00

REED



DIGITAL FORCE GAUGES

- Provides readings of tension (push) or compression (pull) in kg, lb. oz. and Newton units
- Instantly recalls "Peak Load" (max. load) and average readings
- Microprocessor assures $\pm 0.2\%$ accuracy and fast 0.8 second update time
- 100% Zero/Tare control enables maximum pre-load to be stored in the memory
- Zero Adjust push-button and Peak Hold switch
- Selectable fast/slow response
- Large 5-digit LCD display is reversible to match viewing angle
- Holes on the back of the meter case facilitate test stand mounting
- Battery or AC-line operated (uses 6 x 1.5 V "AA" batteries)
- Auto Power Off minimises power consumption and saves battery life
- Includes separate load cell sensor with 2 hooks and cable and carrying case
- Models IA804 and NJW216 include flat head, cone head, chisel head and hook adapters, 120mm extension rod and carrying case, capacity: 20 kg, 44 lbs., 196 N
- Model IA805 includes separate load cell sensor with 2 hooks and cable and carrying case, capacity: 100 kg, 220 lbs., 980 N



IA804

REED

Model No.	Mfg. No.	Description	Price/Each
IA804	SD-6020	20-kg Capacity	895.00
NJW216	SD-6020-NIST	20-kg Capacity w/ISO Certificate	1135.00
IA805	SD-6100	100-kg Capacity	895.00

VIBRATION METERS

- Measures vibration levels in machinery
- Unique vibration sensor with magnetic base
- Peak hold, data hold and max./min. record
- Real time data logger with integral SD memory card (optional)
- Metric or Imperial measurement units
- Acceleration Range: 0.5 to 199.9 m/s²
- Velocity Range: 0.5 to 199.9 mm/s



REED

Model No.	Mfg. No.	Description	Price/Each
IC509	R7000SD	Vibration Meter	995.00
IC510	R7000SD-PROBE	Replacement Vibration Probe	649.00
IC494	RSD-ADP-NA	Power Adapter	39.00
IC495	RSD-16GB	16GB Memory Card	19.00

VIBRATION METER KIT

- Metric or imperial measurement units
- Measures vibration levels in machinery
- Unique vibration sensor with magnetic base
- Peak hold, data hold and max./min. record
- Real time data logger with integral 2GB SD memory card (optional)
- Includes: Data Logging Vibration Meter, 16GB Micro SD memory card with adapter, AC power adapter
- Acceleration Range: 0.5 to 199.9 m/s²
- Velocity Range: 0.5 to 199.9 mm/s



REED

Model No.	Mfg. No.	Description	Price/Each
IC715	R7000SD-KIT	Vibration Meter Kit	1049.00

TAKING THE STRESS OUT OF SPILLS

ZENITH[®]
Safety Products



TIMERS & INSPECTION CAMERAS

COMMERCIAL 4-IN-1 TIMER

- Counts up automatically once timer reaches zero
- Allows you to store and recall the same setting continuously
- Blue back-light
- Splash-proof keypad
- 4 separate time cycles can run at once
- Adjustable volume control knob
- LED light flashes when alarm sounds
- Stand or wall mount
- Low battery indicator
- Batteries included (AC adapter sold separately)
- Max. Time: 99 hr. 59 min. 59 sec.
- Volume: 110 db
- Power: (4) AA Batteries



BIOS
Professional

Model No.	Mfg. No.	Description	Price/Each
IC553	DT202	Commercial 4-in-1 Timer	115.50
IC575	DT203	AC Adapter	14.15

MINI TIMERS

- Easy to use
- Slim design
- Counts up or down to a maximum of 99 minutes, 59 seconds
- Magnetic back
- Pocket size
- Rubberized finish



BIOS
Professional

Model No.	Mfg. No.	Description	Price/Each
IA809	138HC	Mini Timer	7.75

JUMBO DIGITAL TIMERS

- Jumbo LCD display
- Minutes and seconds
- Count down timer
- 30-second beeper alarm
- Magnetic back, built-in clip, retractable stand



BIOS
Professional

Model No.	Mfg. No.	Description	Price/Each
HX500	DT122	Digital Timer	15.75

RECORDABLE BORESCOPE INSPECTION CAMERA

REED

- Camera and video functions save high resolution images and video
- High-resolution, 2.5", color, LCD monitor
- Waterproof (IP67) camera head
- 39" (1 m) Gooseneck cable retains configured shape
- Four high-visibility LED lights
- 180° mirror rotation function
- Low battery indicator and auto shut off after 10 minutes
- Expandable memory up to 32Gb (SD card sold separately)
- Expandable cable up to 30 ft. (9m) with extensions (optional)
- Includes: Video Borescope Inspection Camera, Recordable, 9mm Camera Head, Camera Probe, Borescope, Magnet, Hook and Mirror Attachments, Batteries, USB Cable, and Hard Carrying Case
- Resolution: 640 x 480 pixels
- Camera Head: 9 mm (0.35")
- Digital Zoom: 4x
- Time and Date Stamp: Yes
- Data Output: USB/SD Card
- Power Supply: 4 AA Batteries



Model No.	Mfg. No.	Description	Price/Each
IB888	R8500	Recordable Borescope Inspection Camera	249.00
IB889	R8500-3MEXT	9.84' (3m) Cable Extension	79.00
IB890	R8500-5M9MM	16.4' (5m) Replacement Camera Head on Cable	239.00
IB892	R8500-ART	Articulating Camera	719.00
IB893	R8500-RCH	39" (1m) Replacement Camera Head on Cable	139.00
IB894	R8500-3.9MM	Camera Head	329.00

M12™ M-SPECTOR FLEX™ INSPECTION CAMERA CABLE KIT

- Flush lens prevents build-up, beveled edges reduce friction
- Digitally rotate and zoom images for the ideal view
- Shorter camera head for tighter turns
- Instantly capture images or video with audio from handle or display Digitally rotate and zoom images for the ideal view
- Access saved images or video from a PC using the SD card or USB cable
- Includes: (1) M12™ M-Spector Flex™ 9' inspection camera, (1) M12™ Redlithium™ CP1.5 battery pack (48-11-2401), (1) M12™ Lithium-ion battery charger (48-59-2401), (1) USB cable, (1) SD card, (1) Carrying case
- Display Size: 3.5"
- Resolution: 640 x 680 pixels
- Camera Head: 12.5 (0.49")
- Cable Length: 9'



Model No.	Mfg. No.	Description	Price/Each
UAE198	2316-21	Inspection Camera Cable Kit	739.00

R9000 PIPE VIDEO INSPECTION SYSTEM

REED

- Cost effective portable inspection camera
- Designed to deliver quality video inspection in a wide range of applications including: sewers, building ducts/piping, wells, and power plants
- System includes camera head, cable reel, battery pack and DVR
- Camera head contains 12 white LED lights, a flexible spring coiled joint to navigate corners, a scratch-resistant sapphire lens cover and a stainless steel housing that allows the camera to withstand various hits
- High resolution CCD chip is designed to capture bright, crisp, colour video of the inspection area
- Cable reel is mounted and rotatable in the case, therefore the cable can be extended without the need to hold the reel
- Sun visor is included to act as a sun shield for outdoor inspections
- DVR Resolution: 800 x 480 RGB • DVR Output: TV and Audio
- External Memory: Supports SD memory card up to 32GB
- Viewing Angle: 140° • Display Size: 7" • Camera Head: 0.9" (23 mm)

Model No.	Mfg. No.	Description	Price/Each
IB751	R9000	Pipe Video Inspection System	2395.00
IB833	R9000-RCH	Replacement Camera Head for Pipe Video Inspection System	595.00
IB895	R9000-40M	Cable Extension	749.00
IB896	R9000-CAMT	Camera Head with Transmitter	995.00
IB897	R9000-RCV	Portable Inspection Camera Receiver	1995.00



MANOMETERS

PROCESS GAUGES

- Stamped aluminum 4 1/2" (115 mm) diameter dial
- Black, impact resistant phenolic case
- 316 stainless steel bourdon tube and socket
- Silicone fluid filled and rated for -50° to 170°F
- 1/2% of full scale accuracy
- Transient over-pressure limit: 30%
- Restrictor screw
- Shatterproof glass lens
- Integral back flange
- Safety blowout backplate
- Micrometer adjustable pointer
- 1/4" or 1/2" NPT male connection bottom



IA361

BAKER INSTRUMENTS

1/4" NPT		1/2" NPT		Dial Ranges	Price /Each
Model No.	Mfg. No.	Model No.	Mfg. No.		
IA399	LF45-15-1/4	IA351	LF45-15-1/2	30"-0-15 PSI	169.00
IA335	LF45-30-1/4	IA352	LF45-30-1/2	30"-0-30 PSI	169.00
IA336	LF45-60-1/4	IA353	LF45-60-1/2	30"-0-60 PSI	169.00
IA337	LF45-30HG-1/4	IA354	LF45-30HG-1/2	30"-0 Hg Vac.	169.00

1/4" NPT		1/2" NPT		Compound Scale Dial Ranges	Price /Each
Model No.	Mfg. No.	Model No.	Mfg. No.		
IA338	LF45-15P-1/4	IA355	LF45-15P-1/2	0-15 PSI/0-100 kPa	169.00
IA339	LF45-30P-1/4	IA356	LF45-30P-1/2	0-30 PSI/0-200 kPa	169.00
IA340	LF45-60P-1/4	IA357	LF45-60P-1/2	0-60 PSI/0-400 kPa	169.00
IA341	LF45-100P-1/4	IA358	LF45-100P-1/2	0-100 PSI/0-700 kPa	169.00
IA342	LF45-160P-1/4	IA359	LF45-160P-1/2	0-160 PSI/0-1100 kPa	169.00
IA343	LF45-200P-1/4	IA360	LF45-200P-1/2	0-200 PSI/0-1400 kPa	169.00
IA344	LF45-300P-1/4	IA361	LF45-300P-1/2	0-300 PSI/0-2100 kPa	169.00
IA401	LF45-400P-1/4	IA362	LF45-400P-1/2	0-400 PSI/0-2800 kPa	169.00
IA345	LF45-600P-1/4	IA363	LF45-600P-1/2	0-600 PSI/0-4200 kPa	169.00
IA400	LF45-1500P-1/4	IA365	LF45-1500P-1/2	0-1500 PSI/0-10,500 kPa	169.00
IA347	LF45-2000P-1/4	IA366	LF45-2000P-1/2	0-2000 PSI/0-14,000 kPa	169.00
IA348	LF45-3000P-1/4	IA367	LF45-3000P-1/2	0-3000 PSI/0-21,000 kPa	169.00
IA350	LF45-10000P-1/4	IA369	LF45-10000P-1/2	0-10,000 PSI/0-70,000 kPa	169.00

PRESSURE GAUGES

- Stamped aluminum 2.5" diameter dial
- Polished stainless steel case
- Glass lens, pressed bezel
- Bronze tube and brass socket with brass movement
- 1/4" male NPT connection, bottom or back
- 1.6% accuracy
- Glycerine fill provides a dampening effect which minimises pulsations; continuously lubricates gauge movement; and makes this gauge ideally suited for adverse environments



IA297

BAKER INSTRUMENTS

Bottom Conn.	Price	Back Conn.	Price	Compound Scale	Dial Ranges	
Model No.	/Each	Model No.	/Each	Model No.	Mfg. No.	
IA293	AVNC-30HG	23.00	IA309	AHNC-30HG	29.00	30" Hg-0" Vac.
IA292	AVNC-30	23.00	IA310	AHNC-30	29.00	30" Hg-0-30 PSI
IA294	AVNC-15P	23.00	HX508	AHNC-15P	29.00	0-15 PSI/0-100 kPa
IA295	AVNC-30P	23.00	IA312	AHNC-30P	29.00	0-30 PSI/0-200 kPa
IA296	AVNC-60P	23.00	IA313	AHNC-60P	29.00	0-60 PSI/0-400 kPa
IA297	AVNC-100P	23.00	IA314	AHNC-100P	29.00	0-100 PSI/0-700 kPa
IA298	AVNC-160P	23.00	IA315	AHNC-160P	29.00	0-160 PSI/0-1100 kPa
IA299	AVNC-200P	23.00	IA316	AHNC-200P	29.00	0-200 PSI/0-1400 kPa
IA300	AVNC-300P	23.00	IA317	AHNC-300P	29.00	0-300 PSI/0-2100 kPa
IA301	AVNC-400P	23.00	IA318	AHNC-400P	29.00	0-400 PSI/0-2800 kPa
IA302	AVNC-600P	23.00	IA319	AHNC-600P	29.00	0-600 PSI/0-4200 kPa
IA303	AVNC-1000P	23.00	IA320	AHNC-1000P	29.00	0-1000 PSI/0-7000 kPa
IA304	AVNC-1500P	23.00	IA321	AHNC-1500P	29.00	0-1500 PSI/0-10,500 kPa
IA305	AVNC-2000P	23.00	IA322	AHNC-2000P	29.00	0-2000 PSI/0-14,000 kPa
IA306	AVNC-3000P	23.00	IA323	AHNC-3000P	29.00	0-3000 PSI/0-21,000 kPa
IA307	AVNC-5000P	23.00	IA324	AHNC-5000P	29.00	0-5000 PSI/0-35,000 kPa
IA308	AVNC-6000P	23.00	IA325	AHNC-6000P	29.00	0-6000 PSI/0-42,000 kPa

PRESSURE GAUGES

- 4.5" diameter dial has dual English/metric scales
- Balanced adjustable black pointer
- Corrosion resistant stainless steel case and ring, plastic lens
- Soft soldered phosphor bronze tube with brass socket recommended for average general use
- Suitable for steam, water, air, oil, gas or any medium not corrosive to copper alloys
- 1/4" NPT bottom connection only
- 1% accuracy



IA328

BAKER INSTRUMENTS

Model No.	Mfg. No.	Dial Range	Figure Intervals	Smallest Graduation	Price /Each
IA326	421 AVND-30	0-30 PSI/0-200 kPa	5 PSI	0.5 PSI	44.00
IA327	421 AVND-60	0-60 PSI/0-400 kPa	10 PSI	1 PSI	44.00
IA328	421 AVND-100	0-100 PSI/0-700 kPa	10 PSI	1 PSI	44.00
IA329	421 AVND-160	0-160 PSI/0-1100 kPa	20 PSI	2 PSI	44.00
IA330	421 AVND-200	0-200 PSI/0-1400 kPa	20 PSI	2 PSI	44.00
IA331	421 AVND-300	0-300 PSI/0-2100 kPa	50 PSI	5 PSI	44.00
IA332	421 AVND-500	0-500 PSI/0-3500 kPa	50 PSI	5 PSI	44.00
IA333	421 AVND-30 VAC	30"-0 Hg Vac	5"	0.5"	44.00

PRESSURE GAUGES

- 2.5" diameter dial has dual English/metric scales
- ASME Grade B accuracy: ± 3% first 3rd of scale, ± 2% middle 3rd of scale, and ± 3% last 3rd of scale
- Corrosion resistant stainless steel case and ring, acrylic lens
- Brass internal materials
- 1/4" NPT bottom connection only
- Rated for -20 to 60°C and pressure steady at 75% f.s.



IA285

BAKER INSTRUMENTS

Model No.	Mfg. No.	Dial Ranges	Price/Each
IA280	LVBNA-30HG	0-30" Hg Vac.	10.00
IA281	LVBNA-30	30" Hg Vac to 30 PSI	10.00
IA282	LVBNA-15P	0 to 15 PSI/0 to 105 kPa	10.00
IA283	LVBNA-30P	0 to 30 PSI/0 to 210 kPa	10.00
IA284	LVBNA-60P	0 to 60 PSI/0 to 420 kPa	10.00
IA285	LVBNA-100P	0 to 100 PSI/0 to 700 kPa	10.00
IA286	LVBNA-160P	0 to 160 PSI/0 to 1120 kPa	10.00
IA287	LVBNA-200P	0 to 200 PSI/0 to 1400 kPa	10.00
IA288	LVBNA-300P	0 to 300 PSI/0 to 2100 kPa	10.00
IA289	LVBNA-400P	0 to 400 PSI/0 to 2800 kPa	10.00
IA290	LVBNA-600P	0 to 600 PSI/0 to 4200 kPa	10.00
IA291	LVBNA-1000P	0 to 1000 PSI/0 to 7000 kPa	10.00

MANOMETERS

- Digital display of gauge or differential
- Select from one of 11 different pressure units
- Data hold
- Max/Min Record
- Display backlight
- Auto power off
- Low battery indicator
- Simple fittings for hose connection
- Includes hard carrying case, 9 V battery, connection hose and manual
- Pressure Range: IA138 and NJW152: 0 to 30 PSI; IA139 and IC564: 0 to 100 PSI



IA138

REED

Model No.	Mfg. No.	Description	Price/Each
IA138	R3030	Digital Manometer	349.00
NJW152	R3030-NIST	Digital Manometer with ISO Certificate	574.00
IA139	R3100	Digital Manometer	429.00
IC564	R3100-NIST	Digital Manometer with ISO Certificate	654.00

ELECTRONIC DIGITAL MICROMETERS

- Large LCD display provides easy-to-read numbers
- Carbide tipped measurement surfaces
- Resolution to 5 decimal places
- Linear accuracy: +/- .0001" (.003 mm)
- Inch/millimetre conversion
- Includes calibration wrench
- Zero at any position
- Automatic OFF button
- Lock screw to hold mechanism in position
- Includes: (1) Thimble ratchet, (2) Type LR44 1.5 V batteries, (1) Plastic storage case with foam insert



AURORA
TOOLS

Model No.	Measurement Range	Resolution	Price /Each
IA388	0-1" (0-25mm)	0.00005" (0.001mm)	110.00

COATING THICKNESS GAUGE

- Designed for non-invasive coating thickness measurements
- Features zero or two point calibration, user adjustable high/low alarms, and a USB interface to further analyse results in the included software
- Automatically detects ferrous and non-ferrous substrates
- Easy-to-read colour LCD display
- 360° screen rotation allows users to view measured readings from any angle
- Durable gauge and probe construction
- Single or multi-point mode allows a user to set tolerances and quickly identify whether a coating passes or fails
- Tri-colour LEDs quickly indicate when measurements are below (red), above (yellow), or within set parameters (green)
- Internal memory stores up to 500 groups of data
- View stored data, charts or real-time measurement with software
- Low battery indication and auto shut off
- Includes: (1) Coating thickness gauge, (1) Ferrous substrate, (1) Non-ferrous substrate, (5) Reference films, (1) USB cable, (1) Wrist strap, (1) Sensor cover, (2) AA batteries, (1) Hard carrying case
- Display Type: Digital
- Measuring Range: 0 - 1250 µm (0.1 - 49.2mil)
- Accuracy: 0 to 1250 µm (±3% +1 µm), 0 to 49.21 mil (±3% +0.04 mil)
- Resolution: 0 to 99.9 µm (0.1 µm), 100 to 1250 µm (1 µm), 0 to 4.99 mil (0.01 mil), 5.0 to 49.2 mil (0.1 mil)
- Measurement Modes: Single & Continuous
- Certification: CE



REED

Model No.	Mfg. No.	Description	Price/Each
IC486	R7800	Coating Thickness Gauge	329.00
IC487	R7800-NIST	Coating Thickness Gauge with ISO Certificate	599.00

POCKET RULE

- English units on one edge and metric on the other
- 1/64 to mm conversion chart on the back end of ruler
- Cross piece is very handy for measuring depths and thicknesses
- Includes pocket clip
- Length: 6"
- Width: 1/2"
- Graduations: 1/64" (1 mm)
- Material: Steel



Mitutoyo

Model No.	Mfg. No.	Description	Price/Each
HD513	950-300	Pocket Rule	15.50

ALL STAINLESS STEEL ELECTRONIC DIGITAL CALIPERS

- Large LCD display provides easy-to-read numbers
- Precision adjustments for accurate measurements
- Hardened stainless steel head and body
- Lock screw to hold slide in position
- Linear accuracy: +/- .001" (.03 mm)
- Inch/millimeter conversion
- Zero at any position
- ON/OFF button
- Includes: Two 1.5 V batteries, type LR44 and deluxe storage case with foam inserts

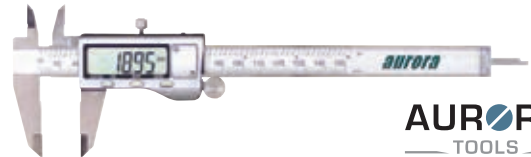

AURORA
TOOLS

Model No.	Size	Measurement Range	Approximate Jaw Depth	Price/Each
TGZ370	6	0-6" (152 mm)	1 9/16" (40 mm) outside, 13/16" (21 mm) inside	61.60
TJZ861	8	0-8" (200 mm)	1 13/16" (46 mm) outside, 1" (26 mm) inside	74.75
THZ769	12	0-12" (300 mm)	2 3/8" (60 mm) outside, 1" (26 mm) inside	135.00

6" ELECTRONIC DIGITAL CALIPERS

- Large LCD display provides easy-to-read numbers
- Precision adjustments for accurate measurements
- ABS plastic head and stainless steel body
- Lock screw to hold slide in position
- Approximate jaw depth: 1 9/16" (40 mm) outside, 13/16" (21 mm) inside
- Inch/millimeter conversion
- Zero at any position
- Automatic shut OFF
- Includes two 3.0 V batteries, type CR3032 and a deluxe storage case with foam insert



AURORA
TOOLS

Model No.	Measurement Range	Resolution	Price /Each
TLV181	0-6" (0-152 mm)	0.001" (0.03mm)	42.85

ABS DIGIMATIC CALIPER

- Digital readout LCD shows inch or metric units for versatility when measuring
- Advanced onsite sensor (AOS) electromagnetic inductive sensor for resistance to dirt, oil, and water
- Measures inside, outside, depth, and step values for versatility
- Includes protective case and SR44 silver oxide battery



Mitutoyo

Model No.	Mfg. No.	Measuring Range	Resolution	Accuracy +/-	Price /Each
HM704	500-196-30	0"-6" (0 mm-152 mm)	0.0005" (0.01 mm)	0.001" (0.0254 mm)	245.00

SCALES

DIGITAL COUNTING SCALES

- Used for counting and quantity checking
- Primary counting function
- High accuracy load cell
- Large LCD display
- Rechargeable battery
- Full digital calibration
- Tare function
- Auto zero tracking
- Quantity set alarm (checking)
- Back light display
- Accumulation memory quantity
- 1-year warranty



HX133



NOT LEGAL FOR TRADE

Model No	Mfg. No.	Capacity lbs./kg	Graduation lbs./g	Counting Resolutions	Price /Each
HX133	KCS 301-30	66/30	0.002/1	1/30 000	669.00
IA590	KCS 301-15	33/15	0.001/0.5	1/30 000	675.00
IB732	KCS 301-3	6.6/3	0.0002/0.1	1/30 000	705.00
IB733	KCS 301-6	13.2/6	0.0004/0.2	1/30 000	675.00

ELECTRONIC DIGITAL WEIGHING SCALES

- Compact design 12 1/2" D x 11 3/4" W x 45/8" H (32 cm x 30 cm x 12 cm)
- Check-weighing function (HI/LO/Target) and a secondary counting function
- Four weighing modes (g, kg, lbs., oz.)
- Removable stainless steel platform 11 3/4" D x 8 3/4" W (30 cm x 22 cm)
- ABS enclosure
- Large LCD display with both front and rear indicators and level indicator for weighing accuracy
- Rechargeable battery with low battery indicator and AC adapter (included)



IA991



Model No.	Mfg. No.	Capacity kg/g/lbs./oz.	Graduation kg/g/lbs./oz.	Price /Each
NOT LEGAL FOR TRADE				
IA988	KWS-SW06	3/3000/6/96	0.001/1/0.002/0.05	535.00
IA989	KWS-SW12	6/6000/12/192	0.002/2/0.005/0.1	525.00
IA990	KWS-SW30	15/15 000/30/480	0.005/5/0.01/0.2	525.00
IA991	KWS-SW60	30/30 000/60/960	0.01/10/0.02/0.5	519.00
LEGAL FOR TRADE				
IA992	KWS-SW06	3/3000/6/96	0.001/1/0.002/0.05	745.00
IA993	KWS-SW12	6/6000/12/192	0.002/2/0.005/0.1	745.00
IA994	KWS-SW30	15/15 000/30/480	0.005/5/0.01/0.2	745.00
IA995	KWS-SW60	30/30 000/60/960	0.01/10/0.02/0.5	745.00

DIGITAL BENCH TOP SCALE

- Auto off (after 120 seconds of inactivity)
- Full tare capacity
- Bright-blue backlit LCD display
- Low battery and overload indications
- Stainless steel platform
- Transparent cover protects the scale when not in use
- 7 Weighing modes: kg, lbs., g, oz., lb-oz, lb-1/4oz, 1/4oz
- Power supply: 4 x AA rechargeable batteries and power adapter included
- Capacity: 33 lbs./15 kg
- Graduations: 2 g
- Platform Dimensions: 7" L x 7" W

Model No. IB735
Mfg. No. 6015C
Price/Each \$210.00



NOT LEGAL FOR TRADE

BIOS
Professional

WEIGHING SCALES

- Ideal for high humidity and dusty work environment
- Large stainless steel platform is removable for easy cleaning
- Convenient displays on front and rear of the scale allow use from both sides of the worktable
- Meets IP66 (dust tight and protected against a strong water jet) standards

FEATURES:

- Large LCD type display with backlight
- ABS enclosure
- Water and dust resistant
- Secondary counting function
- Four direct keys:
Zero, tare, units/counting, on/off
- Four weight modes: g, kg, oz., lb.
- Operates on A/C power or rechargeable battery(both included)
- Dimensions: 9" W x 9.5" D x 5.75" H



PE129



Model No	Mfg. No.	Capacity lbs./kg	Graduation lbs./kg	Price /Each
NOT LEGAL FOR TRADE				
PE126	KWD 500-5	5/2.5	0.002/0.001	665.00
PE127	KWD 500-10	10/5	0.005/0.002	675.00
PE128	KWD 500-20	20/10	0.01/0.005	679.00
PE129	KWD 500-50	50/20	0.02/0.01	655.00
LEGAL FOR TRADE				
IA591	KWD 500-5	5/2.5	0.002/0.001	879.00
IA592	KWD 500-10	10/5	0.005/0.002	879.00
IA593	KWD 500-20	20/10	0.001/0.005	879.00
IA594	KWD 500-50	50/20	0.002/0.01	879.00

RANGER® COUNT 3000 COMPACT BENCH COUNTING SCALES

A high-precision dedicated counting scale with advanced software for counting and packaging parts.

- Weighing Functions: lbs, oz, lbs:oz, kg or g
- Application Modes: Weighing, Parts Counting, Checkweighing, Checkcounting, Accumulation
- Display: 3-Window, 1 in./26 mm high LCD display with white backlight, 6-digit, 7-segment
- Checkweighing Indicators: 3 LED (yellow, green, red) with configurable operation and alert beeper
- Memory: 30 item library data storage function
- Zero Range: 2% or 10% of full scale capacity
- Tare Range: Full capacity by subtraction
- Stabilization: one second results, with 1 part in 1.5 million precision
- Power: 100-240 VAC/50-60 Hz internal universal power supply, internal rechargeable lead acid battery
- Interface Built-in RS232, optional 2nd platform, 2nd RS232, USB, Ethernet
- Platform Size: 11.8" W x 8.9" D



IA998



NOT LEGAL FOR TRADE

Model No.	Mfg. No.	Capacity kg/g/lbs./oz.	Graduation kg/g/lbs./oz.	Price /Each
IA998	RC1P1502	1.5/1500/3/48	0.00005/0.05/0.0001/0.002	1429.00
IA999	RC31P3	3/3000/6/96	0.0001/0.1/0.0002/0.005	1429.00
IB001	RC31P6	6/6000/15/240	0.0002/0.2/0.0005/0.01	1429.00
IB002	RC31P15	15/15 000/30/480	0.0005/0.5/0.001/0.02	1429.00
IB003	RC31P30	30/30 000/60/960	0.001/1/0.002/0.05	1429.00

PORTABLE ELECTRONIC BALANCES

- Scout SPX is a portable balance designed to meet the most common weighing equipments
- Features a large LCD display
- Removable stainless steel pan
- Weight display in g, kg, oz., lbs., lb.oz.; and Troy ounce or pennyweight units for weighing precious materials
- Powered by four AA batteries (not included) or included AC adapter pack
- Dimensions: 6.0" W x 6.3" D x 2.2" H
- Weight: 1.8 lbs.
- 2-year warranty on parts and labour



HM315

MULTIPLE WEIGHING MODES:

- Parts counting
- % weighing
- Display hold for shipping applications



HX216



NOT LEGAL FOR TRADE

Model No.	Mfg. No.	Capacity	Graduation	Pan Size"	Price /Each
HX216*	SPX222	220 g	0.01 g	4.7 diameter	785.00
HX217*	SPX422	420 g	0.01 g	4.7 diameter	1099.00
IA550*	SPX622	620 g	0.01 g	4.7 diameter	1289.00
HX218*	SPX421	420 g	0.1 g	4.7 diameter	429.00
HM315*	SPX621	620 g	0.1 g	5.5 x 6.7	639.00
IA551	SPX2201	2200 g	0.1 g	5.5 x 6.7	819.00
IA553	SPX6201	6200 g	0.1 g	5.5 x 6.7	1339.00
IA554	SPX8200	8200 g	1 g	5.5 x 6.7	669.00

* Span calibration mass included

COURIER™ 5000 SHIPPING SCALES

- Feature a sturdy low-profile design with stainless steel top, making them tough enough for shipping applications and easy to clean for small veterinary applications
- Data is clearly legible on a large, bright 1.1 in/28 mm display, and UPS system communication protocol is included
- The "Weight Alert" mode will warn users if packages are too heavy, for example, to be sent by post or truck
- Design features 150% overload protection
- ABS indicator, 304 stainless steel platform, powder-coated frame
- Platform Dimensions: 15.7" L x 20.5" W
- Battery Life: 100 Hours with Disposable Batteries
- Working Environment: -10°C – 40°C (14°F – 104°F), 85%RH, Non-Condensing
- Platform Material: Stainless Steel
- Power: USB Cable (Included), 3 AA (LR6) Batteries (Not Included), AC Adapter (Included)
- Units of Measurement: Gram, Kilogram, Pound, Ounce, Pound:Ounce
- Display Type: 7-Segment LCD with Backlight



ID049

NOT LEGAL FOR TRADE

Model No.	Mfg. No.	Capacity lbs.	Platform Dimensions	Readability	Price /Each
ID054	30745897	12	12.6" L x 13" W	0.005 lbs. (0.002 kg)	357.00
ID051	30745898	60	12.6" L x 13" W	0.02 lbs. (0.01 kg)	357.00
ID053	30745796	100	12.6" L x 13" W	0.05 lbs. (0.02 kg)	357.00
ID052	30745797	100	15.7" L x 20.5" W	0.05 lbs. (0.02 kg)	424.00
ID049	30745948	200	15.7" L x 20.5" W	0.1 lbs. (0.05 kg)	424.00
ID050	30745949	400	15.7" L x 20.5" W	0.2 lbs. (0.1 kg)	424.00

PORTION CONTROL SCALES

- Large LCD display - 5/8" high
- Removable stainless steel platform
- Tare weighing function
- 800-hours of battery life
- 2-mode function metric and imperial
- AC adaptor (included) or four AA batteries (not included)



IA557



NOT LEGAL FOR TRADE

Model No.	Mfg. No.	Capacity	Graduation	Price/Each
HX081	KD-200-110	35 oz./1000 g	0.05 oz./1 g	315.00
HX082	KD-200-210	70 oz./2000 g	0.1 oz./2 g	315.00
IA557	KD-200-510	11 lbs./5000 g	0.2 oz./5 g	315.00

PORTION CONTROL SCALES

- Stainless steel easy wipe top
- Quick response
- Overload indicator
- 0.1 oz. increments
- Tare
- Auto power off
- Certification: CE and NSF approved
- Powered by 2 x AAA batteries
- Display: LCD 2.17" x 0.83"
- Accuracy: +/- 0.5%
- Capacity: 5000 g/9 lbs.
- Graduations: 1 g/0.1 oz.
- Platform dimensions: 8 1/4" L x 5 7/8" W



NOT LEGAL FOR TRADE

Model No. IB734
Mfg. No. 6005C
Price/Each \$#/N/A



COMPASS™ CX PORTABLE SCALES

- Simplified two-button operation
- Large backlit display increases readability in dim lighting conditions
- Standard stainless steel pan for durable use
- Ingenious space-saving design, which allows you to stack up to 4 scales to save storage space
- Platform Dimensions: 5-1/2" L x 5" W
- Battery Life: 1000 Hours with Disposable Batteries
- Display: LCD Display with white backlight
- Power: 3 AA Batteries (Included); AC Adapter (Not Included)
- Tare: To capacity by subtraction



IC006



NOT LEGAL FOR TRADE

Model No.	Mfg. No.	Capacity	Graduation	Price/Each
IC006	CX221	220 g	0.1 g	255.00
IC007	CX621	620 g	0.1 g	265.00
IC008	CX1201	1200 g	0.1 g	279.00
IC009	CX2200	2200 g	1 g	255.00
IC010	CX5200	5200 g	1 g	305.00
IC011	30330714		Optional AC Power Adapter	59.90
IC012	30467763		Carrying Case	165.00

SCALES

ECONOMY PRECISION SCALES

- Maximum efficiency at minimal cost
- Top loading scales have a removable stainless steel platter making them easy to keep clean
- Speed and precision at a low price
- Ideal for small lab and educational environments

FEATURES:

- External calibration, brushed stainless steel platter and adapter
- Weights in g, oz., lbs., dwt, oz. t., cnt
- Counting features
- Operating temperature: 10°C to 35°C
- Dimensions: 7" W x 9 3/4" D x 2 1/2" H
- 1-year warranty



PE130



PE131



NOT LEGAL FOR TRADE

Model No.	Mfg. No.	Capacity	Graduation	Platter Dimension	Price/Each
PE130	KLE-200	200 g	0.1 g	4.6" diameter	305.00
PE131	KLE-2000	2000 g	1 g	5" x 6.5"	305.00

PRECISION SCALES

- Fast microprocessing speed and digital filtration are the key to peak performance and stability
- Single direction RS-232 allows you to connect to peripheral devices
- Leveling bubble is included and all four feet are adjustable
- Features external calibration
- Brushed stainless steel platter and adapter
- Weights in g, oz., lbs., dwt, oz. t., cnt and KHA 0.01 g also weights in CT
- Counting features
- Operating temperature: 10°C to 35°C
- 1-year warranty

PE136



PE137

NOT LEGAL FOR TRADE

Model No.	Mfg. No.	Capacity	Graduation	Platter Dimensions W" x D"	Price /Each
PE136	KHA-1000R	1000 g	0.01 g	4.75 x 4.75	849.00
PE137	KHA-1201R	1200 g	0.1 g	6.94 x 6.94	549.00
IA781	KHA-5001R	5000 g	0.1 g	6.94 x 6.94	625.00



PESOLA® MICRO SPRING SCALES

- Rotatable bow allows for ideal position of scale reading
- Screw for tare and for adjusting the zero position (range of tare = 20%)
- Innovative adjustment and suspension of spring
- Precise graduation, high resolution, abrasion-resistant and anodized colour
- Eye-clip with lower suspension rotates by 360°
- Eye-clip allows easy interchange of lower suspension with other accessories
- Vertical measuring position



Model No.	Mfg. No.	Capacity	Graduation	Price /Each
IB694	20010	10 g	0.1 g	75.00
IB695	20030	30 g	0.25 g	68.00
IB696	20060	60 g	0.5 g	73.00
IB697	20100	100 g	1.0 g	73.00

PESOLA® MEDIO SPRING SCALES

- Rotatable bow allows for ideal position of scale reading
- Screw for tare and for adjusting the zero position (range of tare = 20%)
- Innovative adjustment and suspension of spring
- Precise graduation, high resolution, abrasion-resistant and anodized colour
- Integrated recoil absorption (important for tensile tests with drag pointer 4.012 (IB721))
- Clear marker reading line on level of graduation
- Eye-clip allows easy interchange of lower suspension with other accessories



Model No.	Mfg. No.	Capacity	Graduation	Price /Each
IB698	40300	300 g	2 g	85.00
IB699	40600	600 g	5 g	85.00
IB700	41000	1000 g	10 g	81.00
IB701	41002	1000 g	10 g	88.00
IB702*	42500/A	2500 g	20 g	83.00
IB703*	43000	3000 g	30 g	102.00

* Supplied with J hook

PESOLA® MACRO SPRING SCALES

- Rotatable bow allows for ideal position of scale reading
- Screw for tare and for adjusting the zero position (range of tare = 20%)
- Innovative adjustment and suspension of spring
- Precise graduation, high resolution, abrasion-resistant and anodized colour
- Integrated recoil absorption for tensile tests with drag pointer (drag pointer supplied)
- Clear marker reading line on level of graduation
- Swivel hook, rotatable and replaceable by different accessories



Model No.	Mfg. No.	Capacity	Graduation	Price /Each
IB705	80005	5 kg	50 g	165.00
IB707	80015	10 lbs./5 kg	50 g/2 oz.	169.00
IB706	80010	10 kg	100 g	168.00
IB712	80210	20 lbs./10 kg	100 g/4 oz.	172.00
IB708	80020	20 kg	200 g	170.00
IB713	80420	40 lbs./20 kg	200 g/8 oz.	175.00
IB709	80035	35 kg	500 g	176.00
IB710	80050	50 kg	500 g	217.00
IB711	80150	100 lbs./50 kg	500 g/1 lbs.	207.00

TOP LOADING SCALES

- Brushed stainless steel body and stainless platform
- Portable rugged and reliable
- Bold large numbers for easy readability
- Rotating dial
- Tare function



BIOS
Professional

Model No.	Mfg. No.	Capacity	Graduation	Platform Dim. L" x W"	Price /Each
NOT LEGAL FOR TRADE					
IB736	620SC	2.2 lbs./1 kg	5 g/0.25 oz.	6 x 6	49.90
IB738	622SC	25 lbs./12 kg	50 g/0.125 lbs.	8 x 8	80.00

TOP LOADING SCALES

- Large stainless steel and enamel platforms to accommodate a variety of package sizes
- Bold graphics improves reading accuracy and ease
- Portable, rugged and reliable



KILOTECH
www.kilotech.com

Model No.	Mfg. No.	Capacity	Case Finish	Platform Dim. W" x D"	Price /Each
NOT LEGAL FOR TRADE					
PE446	KAM1101PL	11 lbs./5 kg	Enamel	7 1/2 x 7 1/2	269.00
PE447	KAM2501SPL	26 lbs./12 kg	Stainless Steel	7 1/2 x 7 1/2	269.00
PE449	KAM5002PL	50 lbs./22 kg	Enamel	10 3/4 x 9 1/2	289.00
HX129	852300	100 lbs./40 kg	Enamel	13" L x 13" W	705.00
HX131	852350	200 lbs./90 kg	Enamel	15-1/2" L x 15-1/2" W	745.00

DIGITAL WEIGHING SCALES

- Ideal for packing functions and quality control
- Convenient tare feature
- Large LCD display
- Full digital calibration
- Auto zero tracking
- Weight accumulation feature
- Power Supply: Rechargeable Battery(Included) or AC Adapter



KILOTECH
www.kilotech.com

Model No.	Mfg. No.	Capacity	Graduation	Platform Dimensions L" x W"	Price /Each
NOT LEGAL FOR TRADE					
HX132	851253	60 lbs.	0.002 lbs.	9.5 x 11	605.00

RECEIVING SCALES

These scales are heavy-duty, general purpose and are suitable for light industrial or shipping applications.

FEATURES:

- Kg/lbs. modes
- Programmable Auto-Off function
- Removable stainless steel platform (IA559, HX632, HX633, IA558, IA782, and IA783)
- Fixed mild steel checkered platform (IA564 and IA453)
- 4 1/2" x 1 1/2" LCD display (IA559, HX632, HX633 and IA558)
- 3" x 1 1/4" LCD display (IA564 and IA453)
- Platform size: 11.75" x 12.25" (IA559, HX632, HX633, IA558, IA564 and IA453)
- 14" x 16" (IA782 and IA783)
- Zero, tare and kg/lbs. (toggle) keys
- Heavy-duty 8' coiled cord
- Power supply: Six AA alkaline batteries (not included) or 120 V AC adapter (included)
- 1-year warranty



KILOTECH
www.kilotech.com

Model No.	Mfg. No.	Capacity	Graduation	Price/Each
NOT LEGAL FOR TRADE				
IA559	KPS-25-2	55 lbs./25 kg	0.02 lbs./10 g	549.00
HX632	KPS-50-2	110 lbs./50 kg	0.05 lbs./20 g	549.00
IA782	KPS-60SS	130 lbs./60kg	0.05 lbs./20 g	679.00
IA564	KPS-68MS	150 lbs./68 kg	0.2 lbs./100 g	469.00
IA558	KPS-150-2	330 lbs./150 kg	0.2 lbs./100 g	565.00
IA783	KPS-150SS	330 lbs./150kg	0.1 lbs./50 g	655.00
IA453	KPS-180MS	400 lbs./180 kg	0.5 lbs./200 g	459.00

INTEGRATOR C15 PRICE COMPUTING SCALES

- Price computing simplified- Easy to use, easy to learn, and easy to program
- Visible in all lighting conditions
- Portable -No need to plug in the scale, 12 hour rechargeable battery included
- Multi-interval device-Two scales in one- Finer precision or larger capacity as per your requirements
- 265 PLU- memorizes item name, item code, life, ingredients, Tare & unit price
- Large stainless steel platter
- Dual reading displays (front and rear)
- Printer available as an option
- Platform Dimensions: 8-9/10" L x 13-1/5" W



KILOTECH
www.kilotech.com

Model No.	Mfg. No.	Capacity	Graduation	Price/Each
NOT LEGAL FOR TRADE				
IB772	851509	30 lbs./15kg	0.005 lbs./0.002 kg	959.00
IB774	851510	60 lbs./30kg	0.02 lbs./0.005 kg	959.00
LEGAL FOR TRADE				
IB773	881509	30 lbs./15kg	0.005 lbs./0.002 kg	1155.00
IB775	881510	60 lbs./30kg	0.02 lbs./0.005 kg	1155.00

SCALES

DEFENDER™ 6000 WASHDOWN BENCH SCALE

- Specifically designed for food, chemical and pharmaceutical applications, including production and packaging
- 100-240 VAC / 50/60 Hz universal power supply, hardwired
- Easy access communication ports including RS232 and USB host (included)
- Ethernet and Wi-Fi/Bluetooth
- 316 stainless steel platform and frame, hermetically-sealed, stainless steel load cell
- IP68/IP69K 316 stainless steel housing indicator and mounting bracket
- Knife-resistant front panel
- Features 150% overload capacity protection, bar matrix check light, customizable print templates, menu and key lock, selectable environmental and auto-print settings, stability indicator, overload/underload indicators, auto shut-off, auto tare, and adjustable non-slip rubber feet
- 6-digit, 7-segment white LED, 20 mm high digits display
- Defender 6000 meets metrological approvals, NSF listing, and supporting HACCP systems
- Platform Dimensions: 19-7/10" L x 15-7/10" W



NOT LEGAL
FOR TRADE

Model No.	Mfg. No.	Capacity lbs.	Graduations	Price /Each
IC793	30575566	100	5 g	3565.00
IC794	30575567	300	10 g	3565.00

D32XW15VR DEFENDER® 3000 WASH-DOWN BENCH SCALE

- Features a NEMA 4X/IP66 stainless steel indicator built to endure tough industrial elements
- Durable construction with a 304 stainless steel platform, stainless steel tubular frame, column and indicator bracket, and IP67 stainless steel load cell
- Easy-to-read display & basic counting mode allow for simple operation for everyday basic industrial applications
- The 58-hour rechargeable battery offers continuous operation for multi-day operations
- Capacity: 33 lbs.
- Graduations: 0.005 lbs.
- Platform Dimensions: 14" L x 12" W
- Power Supply: AC Power (Included) or Rechargeable Battery (Included)



LEGAL
FOR TRADE

Model No. IC151
Mfg. No. 30369114
Price/Each \$2495.00

CYCLONE BENCH AND PLATFORM SCALE

- Durable thick stainless steel platter allows for heavy loads without bending
- 2 scales in one - Dual range- always the right sensitivity no matter how light or heavy the load
- Back support - Ideal for weighing products in bags or that which require extra support.
- Post mounted indicator - Makes it easy to see the screen
- Three weighing modes: lb., kg, pcs
- Ideal for shipping, receiving, check weighing or counting
- Battery or adapter operated

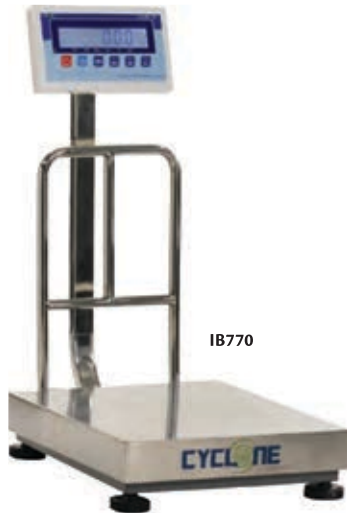

NOT LEGAL FOR TRADE

Model No.	Capacity Range 1	Graduation Range 1	Capacity Range 2	Graduation Range 2	Price /Each
15-3/4" L X 19-7/10" W					
IB770	0-60 kg/0-150 lbs.	20 g/0.05 lbs.	60-150 kg/150-300 lbs.	50 g/0.1 lbs.	985.00
17-3/4" L X 23-3/5" W					
IB771	0-150 kg/0-300 lbs.	50 g/0.1 lbs.	150-300 kg/300-600 lbs.	100 g/0.2 lbs.	1389.00

TOP GUN ELECTRONIC PLATFORM SCALES

- For use in dry environments and areas with low humidity
- Counting function (secondary)
- Hi/Target/Lo (check weighing)
- Accumulation function
- Removable stainless steel platter (1.2 mm gauge) 12" W x 18" D (30.5 x 45.7 cm)
- Built-in level
- Adjustable lockable anti-slip leveling feet
- Predefined capacity settings eliminate installation errors
- Mobile installation
- Choice of ABS or stainless steel indicators



Model No.	Mfg. No.	Indicator*	Frame**	Capacity	Graduation	Price/Each
NOT LEGAL FOR TRADE						
IB011	KPLMS 1218-60	KIN 1000 (ABS)	MS	60 kg/150 lbs.	0.02 kg/0.05 lbs	1179.00
IB012	KPLMS 1218-60	KIN 2000 (WR)	MS	60 kg/150 lbs.	0.02 kg/0.05 lbs	1619.00
IB013	KPLMS 1218-150	KIN 1000 (ABS)	MS	150 kg/300 lbs.	0.05 kg/0.1 lbs	1225.00
IB014	KPLMS 1218-150	KIN 2000 (WR)	MS	150 kg/300 lbs.	0.05 kg/0.1 lbs	1669.00
LEGAL FOR TRADE						
IB015	KPLMS 1218-60	KIN 1000 (ABS)	MS	60 kg/150 lbs.	0.02 kg/0.05 lbs	1369.00
IB016	KPLMS 1218-60	KIN 2000 (WR)	MS	60 kg/150 lbs.	0.02 kg/0.05 lbs	1799.00
IB017	KPLMS 1218-150	KIN 1000 (ABS)	MS	150 kg/300 lbs.	0.05 kg/0.1 lbs	1659.00
IB018	KPLMS 1218-150	KIN 2000 (WR)	MS	150 kg/300 lbs.	0.05 kg/0.1 lbs	1849.00

*Indicator
ABS = ABS Plastic
WR = Stainless Steel
** Frame
MS = Mild Steel

INDUSTRIAL HANGING SCALES

- Cast aluminum scratch resistant body
- Clear shatter resistant face plate
- 7 1/2" Dia., kg and lbs. dial
- Heavy-duty welded steel shackle ring
- Large pointed J-hook
- 1-year warranty

IA545



KILOTECH
www.kilotech.com

NOT LEGAL FOR TRADE

Model No.	Mfg. No.	Capacity	Graduation	Price/Each
IA543	KHS-C360	125 lbs./60 kg	0.5 lbs./200 g	379.00
IA544	KHS-C3120	250 lbs./120 kg	1 lbs./500 g	385.00
IA545	KHS-C3250	540 lbs./250 kg	2 lbs./1000 g	389.00

MINI DIGITAL CRANE SCALES

Ideal for light industry, hunters, luggage, parcels etc.

This mini digital crane scale is versatile, reliable, accurate and easy to operate. A quality stainless steel load receptor and cast aluminum housing protect the scale. The combination of circuit and dedicated weighing load cells ensure a stable reading.

- Stainless steel load receptor
- Cast aluminum housing
- LCD screen viewable from 22'
- Tare, Hold, Unit (between kg and lb.), Zero
- Programmable auto-off, auto-zero, manual zero, backlight
- Removable hook for easy cleaning
- For use in a dry environment and areas of low humidity
- 1-year warranty

IA787



KILOTECH
www.kilotech.com

NOT LEGAL FOR TRADE

Model No.	Mfg. No.	Capacity	Graduation	Price/Each
IA784	KHS 200-30	60 lbs./30 kg	0.02 lbs./0.01 kg	259.00
IA785	KHS 200-60	120 lbs./60 kg	0.05 lbs./0.02 kg	265.00
IA786	KHS 200-150	300 lbs./150kg	0.1 lbs./0.05 kg	259.00
IA787	KHS 200-300	600 lbs./300 kg	0.2 lbs./0.1 kg	259.00

DEFENDER™ 3000 FLOOR SCALE

- The scale meets dry weighing needs for industrial and commercial use
- Their high-quality construction is designed to minimize flexing under heavy loads for years of dependable performance
- The indicator features a bright display that changes color when in check mode
- Scale also includes counting and totalization modes
- Ramps and mounting plates are available
- 7 Segment LCD with multicolor backlight
- Communication is standard RS232 and optional USB Device or Ethernet
- Construction features ABS plastic or 304 stainless steel indicator, 5 mm/0.196 in. fixed top plate, black painted steel treaded platform, IP65 stainless steel junction box with side access, alloy steel load cells, two carbon steel eye bolts, painted steel ramp available
- Four load cell mounted feet with self-swiveling ball-in-cup design, painted and stainless steel floor stands (available as accessories)

- Standard(s) Met: NTEP Certified
- Height: 3.5"
- Working Environment: -10°C – 40°C (14°F – 104°F), 85%RH, Non-Condensing
- Platform Material: Painted Steel Diamond Plate
- Units of Measurement: Metric Tons, Kilogram, Pound
- Display Type: 7 Segment LCD with Multicolor Backlight
- Battery Life: 30 Hours with Rechargeable Battery, 100 Hours with Disposable Batteries
- Communication Type: Ethernet (Available as an Accessory), RS232 (Included), USB (Available as an Accessory)



Model No.	Mfg. No.	Capacity lbs.	Platform Dimensions	Readability	Price /Each
ID039	30837692	2500	4' L x 4' W	0.5 lbs. (0.2 kg)	2660.00
ID037	30837604	5000	4' L x 4' W	1 lbs. (0.5 kg)	2540.00
ID040*	30837693	5000	4' L x 4' W	1 lbs. (0.5 kg)	2660.00
ID038	30716508	5000	5' L x 5' W	1 lbs. (0.5 kg)	2784.00
ID041*	30716510	5000	5' L x 5' W	1 lbs. (0.5 kg)	2895.00

* Powder coated



MOBILE PLATFORM SCALE

- No lifting required, roll your dolly directly onto the ramp
- Mobile Wheels and handle allow for effortless movement
- Rugged mild steel checkered platform
- Ideal for small barrels, drums, kegs, tanks, pails and cylinders (non-flammable and non explosive substances)
- Accurate, efficient and profitable - HI/LO/Target, parts counting, %, TARE & data comparison features
- 2 preprogrammed weighing modes kg/lb.
- 3 programmable modes: lb:oz, PCS, %
- Tare, hold, print, zero tracking & digital calibration
- Auto-power off and backlight
- Programmable serial output
- Printing simplified - USB and RS232 interfaces
- Graduations: 0.2 lbs./0.1 kg

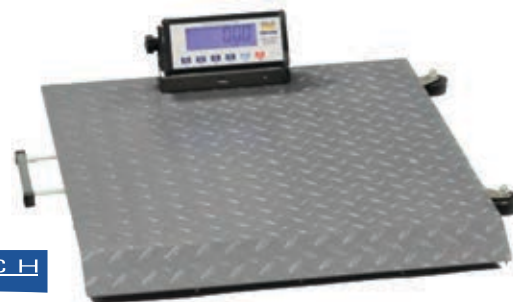

KILOTECH
www.kilotech.com

NOT LEGAL FOR TRADE

Model No.	Mfg. No.	Capacity	Platform Size L" x W"	Price /Each
IB776	851313	132 lbs. / 60 kg	18 x 18	979.00
IB777	851314	330 lbs. / 150 kg	24 x 24	1085.00
IB778	851315	660 lbs./300 kg	30 x 30	1159.00